

Film-Tech

The information contained in this Adobe Acrobat pdf file is provided at your own risk and good judgment.

These manuals are designed to facilitate the exchange of information related to cinema projection and film handling, with no warranties nor obligations from the authors, for qualified field service engineers.

If you are not a qualified technician, please make no adjustments to anything you may read about in these Adobe manual downloads.

www.film-tech.com

DTS-6AD CINEMA PROCESSOR



Installation and Operation Manual

For Digital & Analog Sound Playback with 35mm and 70mm Motion Pictures

March 1, 2000



DTS Europe

Unit 5, Ruscombe Lane
Tavistock Industrial Estate- Twyford
Berkshire, England RG10 9NJ
t: +44.1189.349.199
f: +44.1189.349.198
e: info@dtsonline.co.uk

Digital Theater Systems, Inc.

5171 Clareton Drive
Agoura Hills, CA 91301
t: 1.800.959.4109 or 1.818.706.3525
f: 1.818.706.1868
e: info@dtsonline.com
www.dtsonline.com

DTS Japan (Liasion Office)

AT Communications KK
2-14-4 Shinonome, Koto-ku
135-0062 Tokyo, Japan
t: +81(0)3.5564.7156
f: +81(0)3.3520.1022
e: asano@dtstech.co.jp

TABLE OF CONTENTS

<u>SECTION</u>	<u>PAGE</u>
I. INTRODUCTION AND SPECIFICATIONS	
1.1. About the DTS-6AD	1-1
Standard Features	1-2
1.2. DTS-6AD Technical Specifications	1-3
1.3. Regulatory Notices	1-5
1.4. Unpacking	1-6
1.5. Warranty Information and Return Authorization	1-7
Factory Warranty Information Sheet	1-8
1.6. DTS Technical Support	1-7
DTS Authorized Service Centers	1-7
1.7. Required Equipment, Test Film, and Tools	1-9
II. INSTALLATION, JUMPERS, AND INTERFACING	
2.1. Installing the DTS-6AD into the Sound Rack	2-1
DTS-6AD Rear Panel Drawing	2-1
2.2. Connecting the DTS-6AD	2-2
2.4. D744 Analog (bypass) Board Jumpers	2-3
2.4.1. Jumper Functions	2-3
2.4.2. Factory Settings	2-3
2.4.3. Changing the Jumper Settings	2-3
Drawing showing mounting and adjustment of the display	2-4
Drawing showing boards and RESET button behind the display	2-5
Drawing showing removal of CD-ROM drives	2-6
Fold-out drawing showing D744 jumper locations	2-7
2.5. Auxiliary DC Power Supply Connection	2-9
Drawing, Wiring DC Supply to AUX Connector	2-9
2.6. Adjusting Contrast on the Display	2-9
2.7. Interfacing the DTS-6AD to other Sound Systems/Sources	2-10
Automation Interfacing	2-10
External 6-Track Analog Source	2-10
Dolby™ Model DA20	2-10
External Crossovers	2-10
Internal Crossovers	2-10
Remote Fader	2-11
(Auxiliary) Monitor Speaker	2-11
Digital Amplifiers and Automation	2-11
External Microphone	2-11
NONSYNC	2-11
External Noise Reduction	2-12
2.8. Powering the DTS-6AD, Boot-Up Sequence	2-12
III. FRONT PANEL	
3.1. DTS-6AD Front Panel	3-2
DTS-6AD Front Panel Drawing	3-1
3.2. Fixed Keys	3-2
3.3. (Booth) Monitor Keys	3-2
3.4. Soft (Format) Keys	3-2

TABLE OF CONTENTS

<u>SECTION</u>	<u>PAGE</u>
IV. DTS-6AD INITIAL SETTINGS	
4.1. Setup Check List	4-1
4.2. Clock	4-2
4.3. Surround Delay	4-3
4.4. Speaker Time Alignment Delay	4-4
4.5. Theater Equipment Check	4-5
4.6. Set Preliminary Output Levels	4-6
4.7. Speaker Phase	4-7
V. B-CHAIN ALIGNMENT	
5.1. Setting Output Levels	5-1
Drawing showing suggested microphone placement	5-1
5.1.1. Connecting a Calibrated Microphone or Mic Multiplexer	5-2
5.1.2. Check DTS-6AD Programmed Output Levels	5-2
5.1.3. Measure Preliminary Output Levels	5-3
5.2. Room Equalization	5-4
5.2.1. EQ Programming Procedure	5-4
5.2.2. Copying EQ Settings	5-6
5.2.3. Surround and Subwoofer Channel EQ	5-7
5.2.4. Load/Store Procedure	5-7
5.2.5. Clearing EQ Settings	5-8
5.3. Final Sound Level Adjustments	5-9
5.3.1. SPL Adjustment	5-9
5.3.2. Checking DTS Digital Levels	5-9
5.3.3. DTS Digital Surround Signals	5-10
5.3.4. DTS Digital Subwoofer Level	5-10
Drawing of Subwoofer +10dB In-Band Gain	5-10
5.3.5. Listen to Theater Speakers	5-10
VI. A-CHAIN ALIGNMENT	
6.1. Aligning the Projector's Analog Optics	6-1
Drawing of A-Chain Test Equipment Setup	6-1
6.2. Optical Gain	6-2
6.3. Cell Alignment Check	6-4
6.3.1. Cell Alignment	6-4
6.3.2. Crosstalk Stereo Alignment	6-4
6.4. Slit Loss Compensation	6-5
6.5. Azimuth	6-6
6.6. MONO Adjustment	6-6
6.7. BYPASS Adjustment	6-7
6.8. Final Level Check	6-7
6.9. Projector 2 Alignment	6-8
6.9.1. Projector 2 Optical Gain	6-8
6.9.2. Projector 2 Cell Alignment Check	6-9
6.9.3. Projector 2 Cross-talk Stereo Alignment	6-10
6.9.4. Projector 2 Slit Loss Compensation	6-10
6.9.5. Projector 2 Azimuth	6-11
6.9.6. MONO Adjustment	6-11
6.9.7. Projector 2 Final Level Check	6-11

TABLE OF CONTENTS

<u>SECTION</u>	<u>PAGE</u>
VII. DTS TIMECODE READER HEAD	
7.1. Timecode Reader Head Installation	7-1
7.1.1. 70mm Reader Head Installation	7-1
Drawing, Auxiliary Roller Installation	7-2
Drawing, Breakaway Plate Mounting	7-3
Drawing, Reader Installation	7-4
Drawing, DTS 70mm Reader with Spacer Plates	7-5
(mounting to Kinoton Projector)	
Drawing, DTS Reader with Breakaway Plates	7-6
(mounting to Century JJ Projector w/mag head)	
7.2. Timecode Reader Head Brackets	7-7
Drawings, Reader Brackets	7-8
7.3. Determining Reader Delay Setting	7-14
Setting Sync for DTS 35mm	7-14
Setting Sync for DTS 70mm	7-14
Using Both the DTS 35mm and DTS 70mm Readers With One DTS-6AD	7-14
7.4. Programming Reader (OFFSET) Delay Setting	7-15
7.5. Testing The Delay Setting	7-16
Drawing, DTS 35mm Track Specifications	7-17
Drawing, DTS 70mm Track Specifications	7-18
VIII. FINAL PROGRAMMING	
8.1. Software Menus	8-1
Drawing, Menu Tree	8-2
8.2. Information Menus	8-3
8.2.1. Status	8-3
8.2.2. Version	8-4
8.3. Final Programming Menus	8-4
8.3.1. Password	8-4
8.3.2. Assign F1 Key Format	8-5
8.3.3. NONSYNC Output Mode	8-5
8.3.4. Set Default Format	8-6
8.4. Optional Programming	8-6
8.4.1. Disable Matrix	8-6
8.4.2. Remote Fader Option	8-7
8.4.3. Using the Trim Feature	8-8

TABLE OF CONTENTS

<u>SECTION</u>	<u>PAGE</u>
IX. PERFORMANCE TEST AND OPERATION	
9.1. DTS-6AD System Performance Test	9-1
9.1.1. DTS-6AD Test	9-1
Channel Verification	9-1
CD-ROM Drives Check	9-1
Verify Sound Performance	9-2
Verify BYPASS Operation	9-2
Verify Default Functions	9-3
Verify Booth Monitor Adjustments	9-3
9.1.2. External Equipment Performance with DTS-6AD	9-4
Automation	9-4
External 6-Track Analog Source	9-4
Dolby™ Model DA-20	9-4
6-Track Magnetic	9-4
External Microphone	9-4
Remote Fader	9-4
NONSYNC	9-4
9.2. Operation	9-5
9.2.1. Before the Show	9-5
9.2.2. During the Show	9-6
Film Breaks and Edits	9-7
BYPASS Mode	9-7
Remote Fader	9-8
Dual Projector Operation	9-7
9.2.3. After the Show	9-9
Maintenance	9-9
X. WIRING DIAGRAMS	
WDE237 System Wiring Diagrams	10-2
SDE238 Remote Fader Schematic Diagram	10-7
TI-D435 Timecode Reader Cable Wiring Diagram	10-8
XI. TROUBLESHOOTING AND UPDATING	
11.1. Inside the DTS-6AD	11-1
Diagram, Inside the DTS-6AD	11-2
11.2. User Troubleshooting Tips	11-4
11.3. Technician Troubleshooting Guide	11-6
11.3.1. Display Anomalies	11-6
Drawing, Signal Path	11-7
11.3.2. Power Anomalies	11-10
11.3.3. Logic Anomalies	11-11
11.3.4. CD-ROM Drive & Disc Anomalies	11-13
Replacing a CD-ROM Drive	11-13
11.3.5. Bypass Anomalies	11-13
11.3.6. Monitor Anomalies	11-14
11.3.7. Noise, Distortion, Other Sound Anomalies	11-14
11.4. Blinking Timecode Reader LED	11-16
Drawing, Timecode Signal On Oscilloscope	11-18
11.5. Updating DTS-6AD Software	11-19
11.6. DTS Technical Support	11-19

TABLE OF CONTENTS

<u>SECTION</u>	<u>PAGE</u>
XII. APPENDICES	
<u>Appendix A: Back Panel Connector Pin-Outs</u>	
P1 Monitor In	A-2
P2 To Power Amps	A-3
P3 Monitor Out	A-4
P4 & P5 Projector 1 & Projector 2 Optical Inputs	A-4
P6 External Noise Reduction	A-5
P7A Auxiliary Power	A-5
P8 6-Track Analog In	A-6
P9A/B NONSYNC Left & Right In	A-7
P10A/B RS-422	A-8
P11A/B Automation	A-8
P13 Projector 1 TC (timecode)	A-9
P14 Projector 2 TC (timecode)	A-9
P15 & P16 Status / Control A & B	A-10
P17 RS-232	A-8
P23 Hearing Impaired Out	A-7
P25 L/R SPDIF Out	A-9
P26 LS/RS SPDIF Out	A-9
P27 C/SW SPDIF Out	A-9
P28 Remote Fader	A-7
<u>Appendix B: D744 Analog (bypass) Board Jumper Settings</u>	
Main Audio Outputs: Balanced or Unbalanced	B-2
Screen Channel Outputs: Wideband or Bi-Amped	B-3
Screen Channel Time Alignment Delay	B-4
Screen Loss Compensation Equalization	B-5
External Noise Reduction: Balanced or Unbalanced	B-6
Booth Monitor Wake-up State	B-7
Crossover Resistor Packs	B-8
Appendix C: DTS-6AD System Replacement Parts List	C-1
Appendix D: Using The DTS Empirical Test Disc With The DTS-6AD	D-1
Appendix E: Marquee Order Form	E-1
Appendix F: RT-60 Test Section	F-1
Appendix G: Using the Upload/Download Software Program	G-1
Appendix H: Using the DTS-6AD with Extended Surround Equipment	(future)

NOTES

Thank you for choosing DTS !

SECTION 1 INTRODUCTION AND SPECIFICATIONS

1.1. ABOUT THE DTS-6AD

1.1.1. How the DTS (digital) System Works

The DTS digital sound process for motion pictures is designed for the digital sound release of motion pictures in 6-track theaters. It is a dual system in that the digital audio data is recorded on CD-ROM discs. DTS timecode is printed on the motion picture print along with a conventional stereo optical soundtrack. The timecode is used by the DTS system to synchronize the sound and picture. The timecode lies between the picture and optical sound track, and is printed onto the release print from the soundtrack negative. There is a single inventory of prints.

The DTS system provides left, center, right, stereo surrounds, and subwoofer channels. The system allows for play times up to 5 hours. They are completely automatic and fail-safe in operation requiring no action by the projectionist. The systems automatically start and stop, and track film breaks and change-overs. The digital audio data is sampled at 44.1K samples per second. APTX100 digital audio data compression (4:1) is used. Transfer into the process can be made from conventionally mixed analog or digital sound masters.

1.1.2. How the DTS-6AD Works

The DTS-6AD provides both digital and analog sound playback. It combines the functions of a cinema processor, 6-track digital processor, and booth monitor. The DTS-6AD is capable of playing back stereo optical sound tracks, DTS encoded tracks on motion picture film, as well as an external multi-track analog source.

For digital sound playback, the DTS-6AD uses DTS time-coded film to synchronize DTS digital 6-track sound on DTS movie disc(s) to each frame of film projected. The DTS reader sends timecode information on the film to the DTS-6AD. The DTS-6AD plays the correct sound on the matching movie discs loaded into its CD-ROM drives. The projectionist simply inserts the movie disc(s) into the DTS-6AD and threads the film through the DTS timecode reader. Once the film is started, the DTS system checks a keyed serial number in the timecode and on the movie disc(s) to assure the correct sound is being played with the movie being shown. Films released in the DTS digital sound format also contain a traditional analog (optical) sound track (SR, A-TYPE, or MONO) which serves as a back-up sound source. If a problem occurs in the DTS digital playback, the DTS-6AD switches out of digital and reverts to the proper analog sound format. And at the end of the show, the DTS-6AD automatically switches from DTS digital playback to NONSYNC.

1.1.3. DTS-6AD Standard Features

The following standard features are available on the DTS-6AD system:

- Two stereo optical pre-amplifiers
- Dual projector ready
- One DTS 35mm timecode reader standard, second reader (dual projector) special order
- Dual status and control connections to automation systems
- Selectable crossovers: Internal or external. If internal, customer to select value when ordering.
- DTS 6-track digital output = 5.1 standard and 6.0 special order
- SR-TYPE, A-TYPE, MONO optical sound formats, NONSYNC, DTS digital, and external 6-track
- External noise reduction loop
- Internal pink noise generator
- Three CD-ROM drives
- Automatic adjust AC input from 85 VAC to 264 VAC between 47 Hz and 64 Hz
- Auxiliary (DC) power input
- Status display screen
- L, C, R mix (center weighted) hearing impaired output
- NONSYNC stereo input
- Remote fader connection
- Magnetic sound print master ready: i.e. stereo, Lt/Rt (4:2:4 matrix), or 6-track
- Programmable surround delay
- Built-in booth monitor speaker, volume control, and channel select switches
- Automatic emergency BYPASS functions
- Individual channel and master (overall) volume control
- Individual channel equalization. See technical specifications for details.
- DTS 70mm capable. Used with special order DTS 70mm readers.
- RS232 connection to laptop PC, to upload/download (software driven) programmed audio settings. Used with the “DTS-6AD Upload/Download Program”. WINDOWS™ compatible and is available on the DTS web site (cinema-techcenter) or on floppy disc from DTS.
- SP/DIF digital audio 6-track output
- Trim feature allows user to balance volume of feature film and trailers
- RS422 communications to automation systems (future)

1.2. DTS-6AD TECHNICAL SPECIFICATIONS

Frequency Response	L, C, R: 20 Hz to 20 kHz, LS & RS: 80 Hz to 20 kHz, Sub: 20 Hz to 80 Hz
Dynamic Range:	96 dB, all channels
Size:	7" high (4 rack units), 19" long rack mount, 15½" deep
Weight:	37 LBS.
Fuse (AC supply)	2 amp slow blow, 3AG
Digital EQ:	Screen channels: Third octave EQ bass and treble Surround channels: One octave EQ bass and treble
Analog Input:	D744 jumper selectable: Balanced or unbalanced, all 6 channels & external noise reduction loop D744 jumper selectable: Normal or bi-amped, all 6 channels D744 jumper selectable: Time alignment for screen channels D744 jumper selectable: Screen loss compensation, screen channels only
External 6-track Analog Input:	Unbalanced 300mV
AC input:	85 VAC to 264 VAC between 47 Hz and 64 Hz
Internal Crossover Selections:	500Hz or 800Hz standard. Available by special order: 297 Hz, 330 Hz, 630 Hz, 1000 Hz, 1200 Hz
Automation	Two Status/Control connections available, P15 & P16. See Appendix A for details. P11 (RS422 to digital automation systems) not enabled at this time.
Internal Noise Reduction:	Two channels each for SR-TYPE and A-TYPE optical sound formats
External Noise Reduction In/Out:	Balanced or unbalanced (D744 jumper selectable), 300mV
External Microphone Input Level:	Unbalanced 300mV (although there is not a dedicated connector for this feature, it can be accomplished several ways, see page 2-11).
NONSYNC Input:	Unbalanced, 300mV level for left and right channels
Hearing Impaired Output:	Unbalanced, 300mV output: Center weighted mix of left, center, and right channels.
External Speaker Out:	Requires 8 ohms, self-powered. DTS-6AD outputs 300mV nominal signal.
Auxiliary Power In:	Requires ±12 VDC to ±15 VDC at 2 amps. Used for emergency back-up power.

1.2. DTS-6AD TECHNICAL SPECIFICATIONS (continued)

An external **six-track analog input** is available for a 300mV external source. The two status/control functions connect to theater's **automation** system and to external digital playback systems for sense and control functions. An **external noise reduction** loop connection is selectable for balanced or unbalanced and can be fed into external noise reduction or to output another Lt/Rt signal such as magnetic print-master playback. Matrix may be disabled through software programming, for pure stereo playback.

The **main output** provides user selectable **wideband** or **bi-amped** outputs. Jumpers on D744 analog board allow use of outputs for THX sound systems or speakers with built-in crossovers. If **internal crossovers** are desired, plug-in resistor headers determine crossover frequency: 500Hz and 800Hz standard, other frequencies can be special ordered. Jumpers also select **balanced** or **unbalanced outputs** for all channels, as well as **screen loss compensation** and **time alignment delays** for the screen speakers.

Equalization for screen channels and surrounds is accomplished in the digital domain along with both A-type and SR-type noise reduction. Three **SP/DIF digital** audio pairs are available for left, center, right, subwoofer, and left & right surrounds.

B-chain alignment is easily accomplished with on-screen display and a built-in pink noise generator. EQ settings can be copied from one channel to another, allowing faster setup. Each channel has bass and treble control as well as third/single-octave EQ adjustments. Individual output levels are set with trim-pots, and on-screen level adjustment allows SPL fine-tuning.

A-chain alignment accomplished using test film and the on-screen display. Separate solar cell adjustments are available for both projector inputs.

Built-in **booth monitor** buttons select one or a combination of all 6 output channels, and are selectable between DTS-6AD output and return from power amps. An additional button turns internal speaker on/off. An external speaker connector is available on the rear panel ("MONITOR OUT").

There is an overall **master fader** on the front panel and remote fader connections on the rear panel.

A **NONSYNC** source connector is available and its trim level is menu driven. Signal routing to just the surrounds can be used for audio coverage when curtains are closed.

While in the **BYPASS** mode, the signal from the solar cell is routed to the screen channels, and a trimpot is used to adjust its volume. A toggle switch on the D744 (analog) board can enable the BYPASS mode. The DTS-6AD will also automatically go into the BYPASS mode if a fault occurs on CPU or DSP boards. When BYPASS is enabled, a red LED (on the D744 board) lights to indicate the DTS-6AD is in the BYPASS mode. The D744 board is behind the display screen.

A universal fused **power supply** allows connection to all AC power sources. A standard power cord is provided. An optional DC supply may be used via the "AUX POWER" connector and is used for emergency backup power (± 12 VDC to ± 15 VDC at 2 amps).

1.3. REGULATORY NOTICES

EMI NOTICE

This equipment has been tested and found to comply with the limits for a Class A digital device, pursuant to Part 15 of the FCC Rules. These limits are designed to provide reasonable protection against harmful interference when the equipment is operated in a commercial environment. This equipment generates, uses, and can radiate radio frequency energy and, if not installed and used in accordance with the instruction manual, may cause harmful interference to radio communications. Operation of this equipment in a residential area is likely to cause harmful interference in which case the user will be required to correct the interference at his own expense.

Canadian Department of Communications compliance statement:

This equipment does not exceed Class A limits per radio noise emissions for digital apparatus set out in the Radio Interference Regulation of the Canadian Department of Communications. Operation in a residential area may cause unacceptable interference to radio and TV reception requiring the owner or operator to take whatever steps are necessary to correct the interference.

Avis de conformite aux normes du ministere des Communications du Canada:

Cet equipment ne depasse pas les limites de Classe A D'emission de bruits radioelectriques pour les appareils numeriques telles que perscrites par le Reglement sur le brouillage radioelectrique etabli par le ministere des Communications du Canada. L'exploitation faite en milieu residentiel peut entrainer le brouillage des receptions radio et television, ce qui obligerait le proprietaire ou l'operateur a prendre les dispositions necessaires pour en eliminer les causes.

PATENTS

The DTS system has been granted the following patents:

United States of America Patent Nos. 5155510, 5386255, 5450146, 5751398

Australia Patent Nos. 652965, 661614

Europe Patent Nos. 0551424, 0615631, 0473677, 0632922, 0666495

Japan Patent Nos. 2033555, 2708961

India Patent No. 181427

Russia Patent No. 2088962

Korea Patent Nos. 153028, 0185423

France Patent Nos. 8906807, 9114963

Canada Patent No. 2016028

July 16, 1999

1.4. UNPACKING

The packaging is designed to handle normal shipping and handling. Upon receipt of shipment, check for signs of damage before opening and report all damage to the carrier. All shipments made from DTS are customer responsibility once they leave our premises.

Before installation is begun it is suggested that a complete inventory be taken to minimize problems or questions during installation. Additionally, save all packing material until installation is complete in the unlikely event that a component(s) requires return to the factory. Use the packing slip that came with your unit to verify received inventory.

The following is a sample packing list for a single projector (platter) system:

- DTS-6AD processor and power cord
- Timecode Reader Head, 35mm, P/N D600
- Reader Head Mounting Bracket, P/N D614
- Timecode Reader Head Interconnect Cable, P/N D435
- Installation Hardware (mounting screws, and 2 each 25-pin & 9-pin “D” connectors w/solder cups)
- Manual
- DTS trailer (logo) films, two scope and two flat

NOTES:

For two projector (change-over) systems, an additional D600 reader and D435 cable are required.

If any of the items on your packing list cannot be found, contact DTS with the P/N and description of the missing item(s). Refer to “RETURNS,” before sending any product back to DTS.

RETURNS

For warranty repair, exchange or getting replacement parts, please call your local DTS office or dealer.

A DTS **Return Authorization** number is **required** before sending any item back to the factory. At the time of the call, DTS will require that you provide the serial number of any unit(s) or reader(s) for return **before** warranty replacement units will be sent. All return packaging should be clearly marked with the Return Authorization number on the outside of the package.

Please send all returns to:

North America

Digital Theater Systems, Inc.
5171 Clareton Drive
Agoura Hills, California 91301-4523 USA
Telephone: (818) 706-3525
or toll free in USA: 800-959-4109
Customer Service Fax: (818) 879-2746

Europe

DTS SA
Unit 5, Ruscombe Lane
Tavistock Industrial Estate
Twyford, Berkshire RG10-9NJ UK
Telephone: 44-1189-349199
Fax: 44-1189-349198

1.5. WARRANTY INFORMATION

Equipment manufactured by Digital Theater Systems, Inc. is warranted against defects in materials and workmanship for one year from date of purchase. There are no other express or implied warranties.

Digital Theater Systems, Inc. obligation is restricted to repair and replacement of defective parts. Under no circumstances will Digital Theater Systems, Inc. be liable for any other damage, either direct or consequential.

All requests for repairs or information should include the unit serial number to ensure rapid service.

1.5.1. DTS AUTHORIZED SERVICE CENTERS

DTS has service centers around the world. Please contact your local DTS office for more information.

1.6. DTS OFFICES AND TECHNICAL SUPPORT

North America (corporate headquarters)

Telephone: (818) 706-3525

Fax: (818) 706-1868

DTS engineers are available to assist you. If you have an emergency after business hours, please leave a message on the answering service and we will return your call as soon as possible.

Europe (UK)

Telephone: 44-1189-349199

Fax: 44-1189-349198

INTERNET users may email DTS at the following address cinematech@dtsonline.com

DTS Web Site www.dtsonline.com

In the web site, there is a section called "cinema-techcenter" that contains product information, manuals, technical bulletins, and email access to DTS field engineers. Use of this information is free to internet users. All users are required to fill out the on-line questionnaire before access to this part of the site is granted.

FACTORY WARRANTY INFORMATION

The following is a list of information necessary for every location where the DTS-6AD system is installed.

THEATER NAME/CIRCUIT: _____

THEATER LOCATION: _____

SCREEN NUMBER: _____

THEATER CONTACT/TELE No.: _____

LOCAL TECH/TELE No.: _____

TIMECODE READER S/N(s): _____

DTS-6AD SERIAL NUMBER: _____

PROJECTOR TYPE: _____

CROSSOVERS: (circle one) External _____ Internal _____ ohms

SPEAKER SYSTEMS

SOUND AMPLIFIERS

Screen (model): _____ Amp (model): _____

Surrounds (model): _____ Amp (model): _____

Subwoofer (model): _____ Amp (model): _____

Surrounds: _____ Subwoofer: self powered? _____

DTS requires the above information to provide proper and timely technical support. Fill page out and send to DTS, attention Customer Service, **fax** (818) 879-2746.

Digital Theater Systems, Inc.
5171 Clareton Drive
Agoura Hills, California 91301-4523 USA
Telephone: (818) 706-3525 / (800) 959-4109 (toll free USA only)
www.dtsonline.com

Thank you for choosing DTS!

1.7. REQUIRED EQUIPMENT, TEST FILM, and TOOLS

EQUIPMENT

The following equipment is required:

- Real Time Analyzer
- Single calibrated microphone or mic multiplexer with set of calibrated microphones
- SPL meter
- Oscilloscope
- DTS technician's kit (not included with the DTS system)
The kit is required to adjust and check the DTS digital format. It consists of:
 - DS1, 6-track Setup Disc. To verify digital levels, check automatic default switching, and verify operation of the CD-ROM drives.
 - "Buzz and Bill Show" Film and Disc. To test the DTS digital system's performance.
 - Empirical Test Disc. To test the theater's sound system through the DTS-6AD.
 - DTS trimpot tweaker. To adjust level trim pots.
 - DTS T-Shirt.

TEST FILM

The following test films will be required to adjust and check the (A-chain) optical formats:

- 50% modulation tone test film
- Pink noise test film
- Buzz track film
- 1 kHz cross-talk cell alignment film

TOOLS

The following tools will be needed:

- Scope probe and test leads for A-Chain adjustment. The test leads should have dual-ended plugs at 0.080 inches long and be 2mm in diameter (example: Pomona 3901 or 3221).
- Multimeter
- Flat-bladed and Phillips screwdrivers, various sizes
- Adjustable wrench
- Wire cutters and strippers
- Soldering iron and solder
- Pliers
- Electrical tape
- Flashlight

NOTES

Thank you for choosing DTS !

SECTION 2 INSTALLATION, JUMPERS, AND INTERFACING

2.1. INSTALLING THE DTS-6AD INTO THE SOUND RACK

DTS-6AD cinema processor is designed to mount into a standard 19" wide sound rack. The processor is 7" (4U) tall and 17" deep. Select a space in the sound rack where the processor will be at approximately eye level for most operators. Bolt the DTS processor into the rack. One rack unit of space should remain open above and below the unit in observance of ventilation requirements.

- The ambient temperature within the rack may be greater than room ambient temperature. The maximum temperature for the equipment in this environment is 50°C. Consideration should be given to the maximum rated ambient.
- Installation should be such that the amount of air flow required for safe operation is not compromised, and that a hazardous condition is not achieved due to uneven loading.
- Check nameplate ratings to assure there is no overloading of supply circuits that could have an effect on over-current protection and supply wiring.
- Reliable grounding of this equipment should be maintained. Particular attention should be given to supply connections when connecting to power strips, rather than direct connections to the branch circuit.
- A quality surge / spike suppresser power strip is recommended to protect the DTS-6AD processor.
- **Never block the side vents of the DTS-6AD.** Free air flow within the unit prevents over-heating and keeps dirt from being sucked in through the CD-ROM drives.

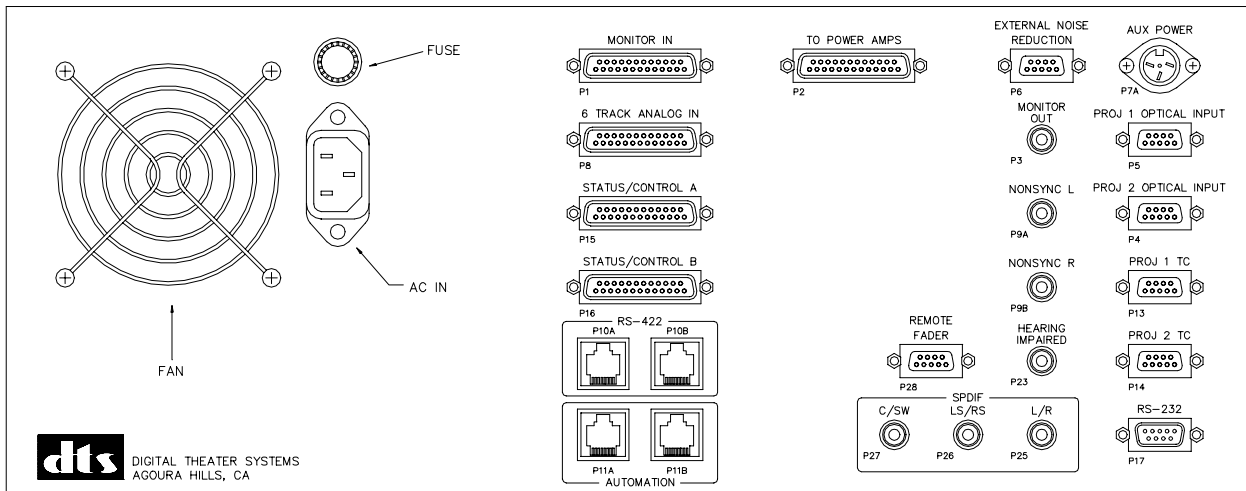

2.2. CONNECTING THE DTS-6AD

Refer to Section 10 Wiring Diagrams or Appendix A Pin-out Tables when making cables. Connections to the DTS-6AD are made primarily via 9-pin or 25-pin “D” connectors, and RCA-type connectors.

- **Ensure that the DTS-6AD front panel power switch is in the OFF position.**
- **Lift off the display panel and verify that all three circuit cards are fully inserted.**

The **solar cell** from the projector is connected to P5 “PROJ 1 OPTICAL INPUT”. If there is a second projector, it is connected to P4 “PROJ 2 OPTICAL INPUT”.

Connect the **timecode** cable (P/N D435) from projector one’s timecode reader to “PROJ 1 TC” (P13) located directly below the optical inputs. If a second projector is used, connect the second timecode cable (P/N D435) to “PROJ 2 TC” (P14). For proper operation, the shield of the timecode cable(s) must be connected to the shell of the 9-pin connector at the projector-end of the cable. NOTE: A “shell” wire is available under the shrink-sleeve at the end of the cable. See diagram D435 in Section 10.

Main **audio output** is available at P2 “TO POWER AMPS”. This connector contains 12 output signals: High and low frequency outputs for *bi-amping* each of the 6 channels. Installations with external crossovers use the *wideband* (HF) outputs only. The LF outputs are not used for wideband applications. **The D744 analog board jumpers must be set for either “bi-amp” or “wideband”.** See Section 2.4.

The **internal crossover** frequency is set by plug-in crossover resistor packs in D744. Consult speaker manufacturer for crossover frequency requirement. See Appendix B for available resistor packs – these must be removed if using unit in WIDEBAND mode.

To verify sound at the speaker amps, connect their outputs to P1 “MONITOR IN”. This enables the use of the front panel **monitor** speaker and its selector switches. Wideband applications use P1 HF inputs only.

As the built-in monitor speaker is for reference only, it will be desirable to attach a self-powered amplified speaker to the P3 “MONITOR OUT” RCA-type connector. The addition of an **auxiliary monitor speaker** provides higher volume capabilities and better frequency response.

A **NONSYNC** source, such as a CD player, connects to P9A “NONSYNC L” and P9B “NONSYNC R” inputs. These are RCA-type connectors and accept 300mV (line level) unbalanced signal. The NONSYNC signal can be a normal stereo or matrix encoded source.

Any **six-track analog** source at a 300mV can be connected to P8 “6-TRACK ANALOG IN”.

Format pulses from an automation system can be connected to either P15 “STATUS/CONTROL A” or P16 “STATUS/CONTROL B”. Any of the six formats, mute, trim feature, or projector changeover can be selected from this connector. These connectors also contain LED drive voltages for a remote status panel.

P23 “HEARING IMPAIRED” output provides a center-weighted mix of the left, center, and right channels for use with a **hearing impaired** sound system.

Connect the **AC power** cable to the DTS-6AD processor. (NOTE: The DTS-6AD processor is a computer based system and as such can be susceptible to power line surges. A good quality surge and spike suppressor made for computers is recommended). Two power supplies provide power to the DTS-6AD unit. Both supplies are fused and automatically adjust to incoming AC mains voltages: From 100 VAC to 240 VAC, between 50 and 60 Hz.

2.3. D744 ANALOG BOARD JUMPERS

Jumper Functions

Before powering the DTS-6AD, verify the jumpers on the D744 analog board are set for your application. The D744 board is programmable (via jumpers) for the following operations:

- Balanced **or** Unbalanced output for all six channels Surrounds and sub don't use crossovers
- Wideband **or** Crossover output for all six channels for 5.1, are available for 6.0 operation.
- Screen loss compensation for Left, Center, and Right channels
- Time alignment delay for Left, Center, and Right channels
- Balanced **or** Unbalanced input and output for external NR connector
- Wake-up state of the booth monitor (Rev. J D744 boards use dip switch instead of jumpers)

Factory Settings

Unless specified otherwise, the DTS-6AD will be shipped with the following settings:

- Balanced Output
- Wide-band Output
- Screen Loss Compensation = OUT
- Time Alignment Delay = OUT
- Balanced Input and Output for External NR connector
- Booth Monitor Wake-up Mode:
 - * Left, Center, Right
 - * Amplifier returns
 - * Internal Speaker = ON

If any of the defaults are not the required configuration, change the jumpers accordingly. Use the "Jumper Settings" tables in Appendix B or drawing on 2-7 to identify and change the correct jumper.

Changing the Jumper Settings

- Turn off the power. The DTS-6AD must not be powered when removing the boards.
- Remove the display by pushing in the two side latches. This should release the display and enable the user to lift it away from the front panel. The display may be hung on the front panel by hooking its side catches to the two inside studs of the panel opening. See drawing on page 2-4.
- There are three circuit boards behind the display. The top board is the **D744** analog board. It contains the jumpers and crossover headers that the user can modify. The middle **D741** board is for Digital Signal Processing. The bottom **D740** board is for CPU functions, stores software memory, and contains the RESET button. The middle and bottom boards require no adjustments and contain no user serviceable parts. They should not be removed.
- Remove the smaller of the two ribbon cables (24-pin) from the display. This cable is permanently attached to the D744 board (top circuit board).
- The D744 board can now be extracted by gently lifting the white levers on each side. The user may now gently slide the D744 board out from the chassis. **Do not pull it out by ribbon cable.**
- To change D744 settings, use drawing on page 2-7 to find appropriate jumpers and crossover headers. This information is also in Appendix B tables and charts.

CONTROL PANEL REMOVAL

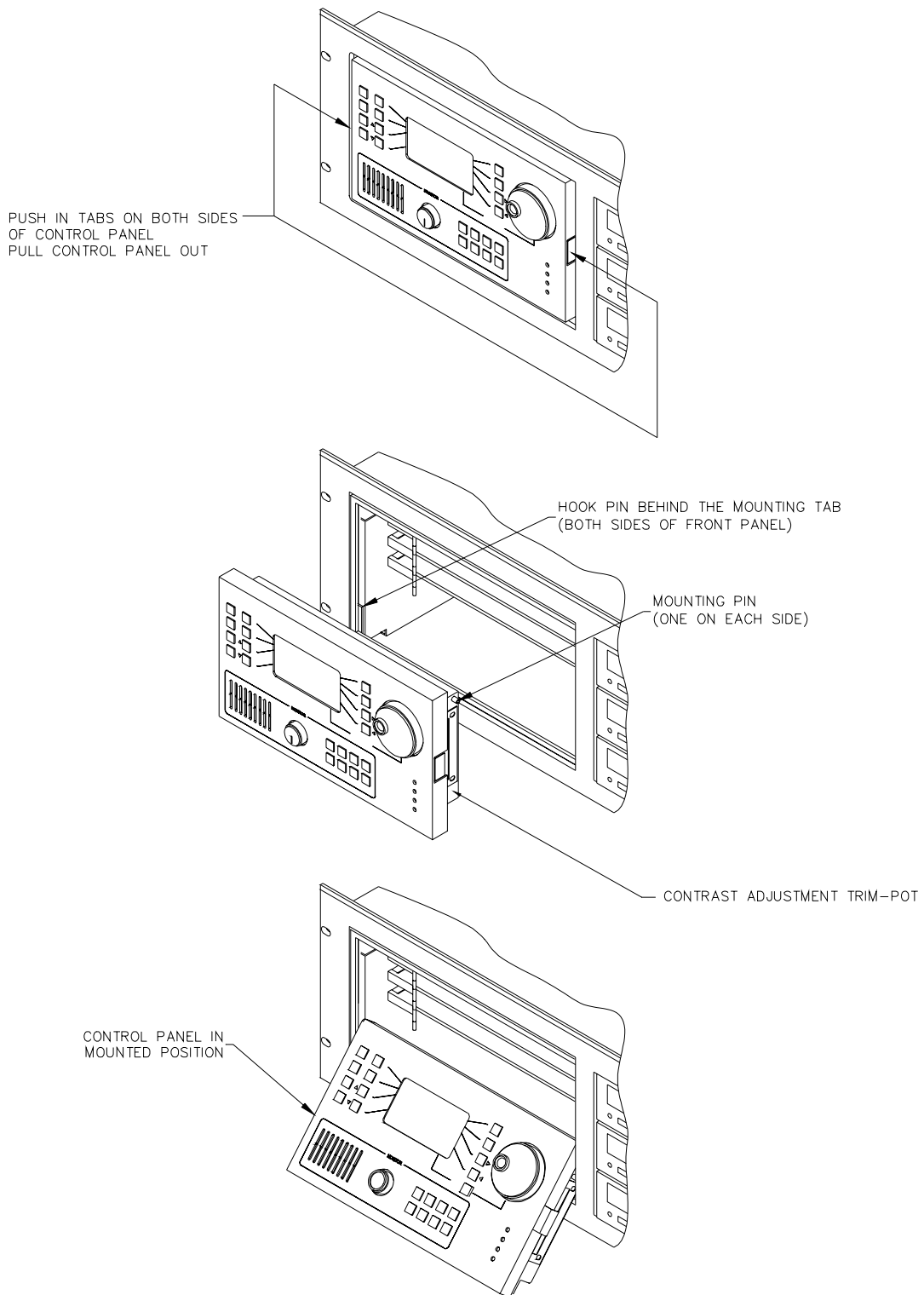

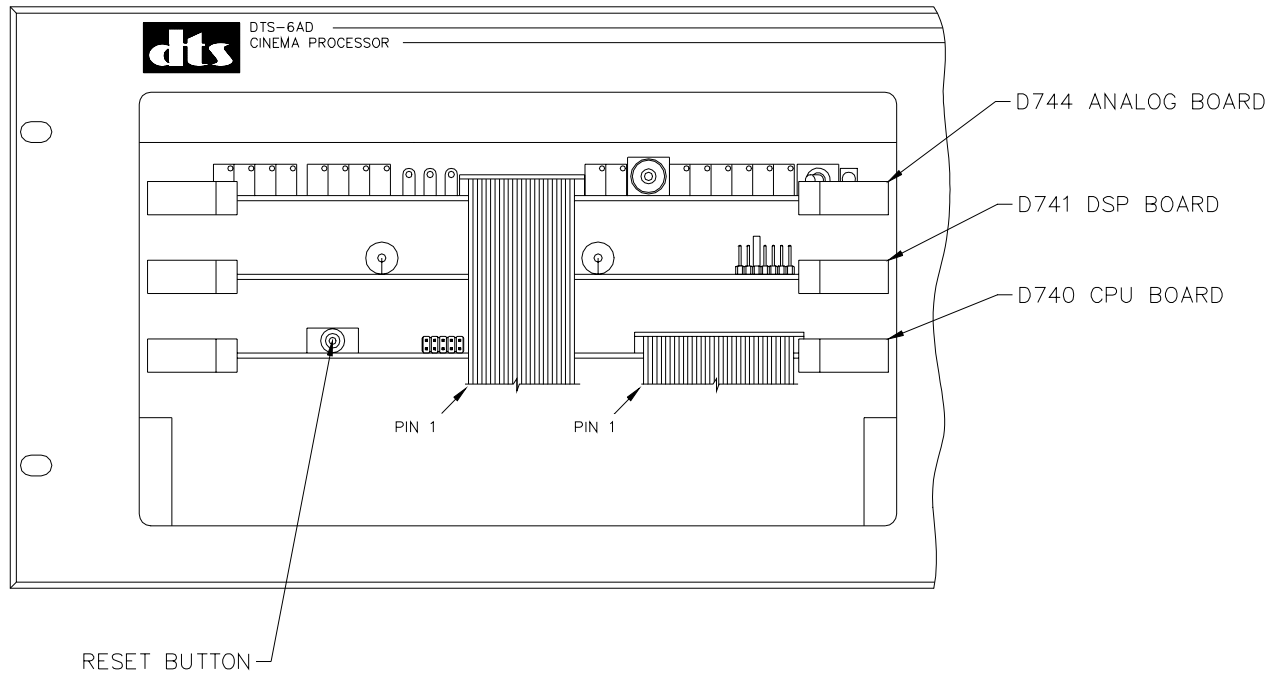

CONTROL PANEL NOT SHOWN

CD-ROM DRIVE REMOVAL

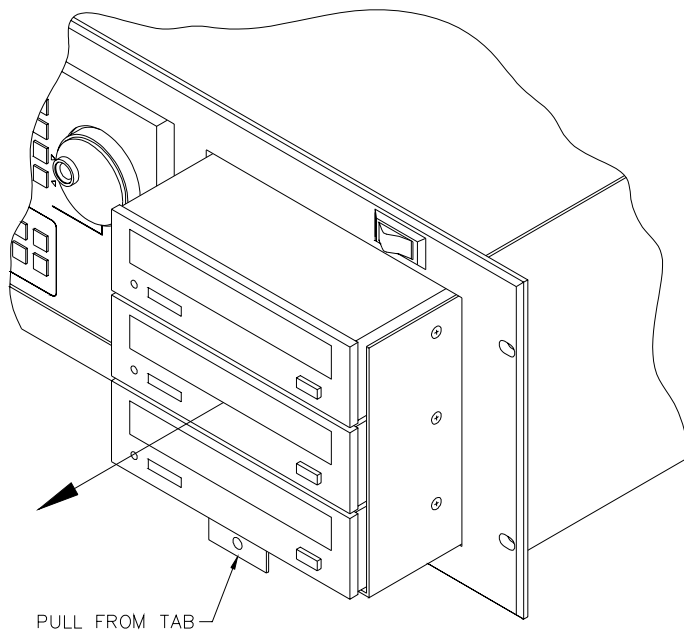
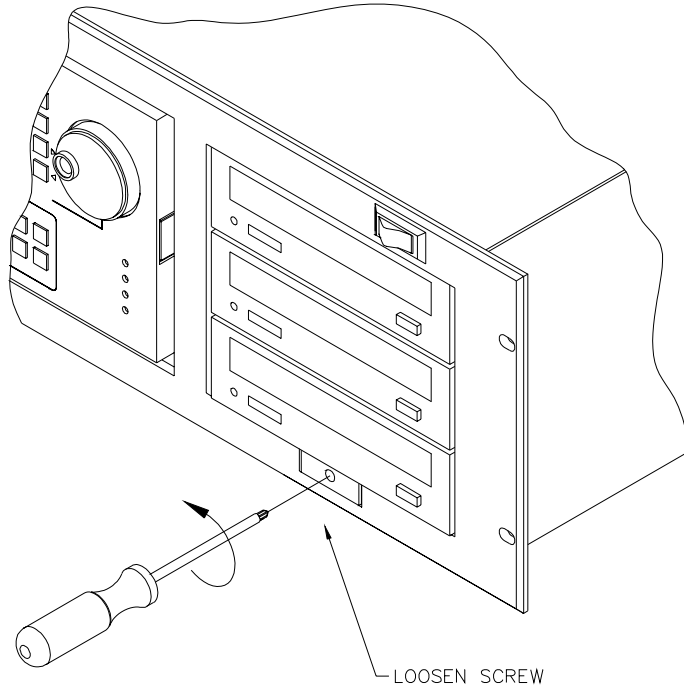

JUMPER SETTINGS FOR TEAC 32X DRIVES *

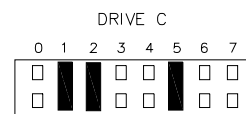
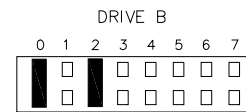
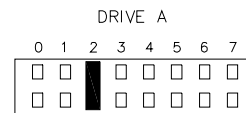

* IF DRIVES ARE NOT TEAC MODEL CD532S (32X), PLEASE CONTACT DTS.

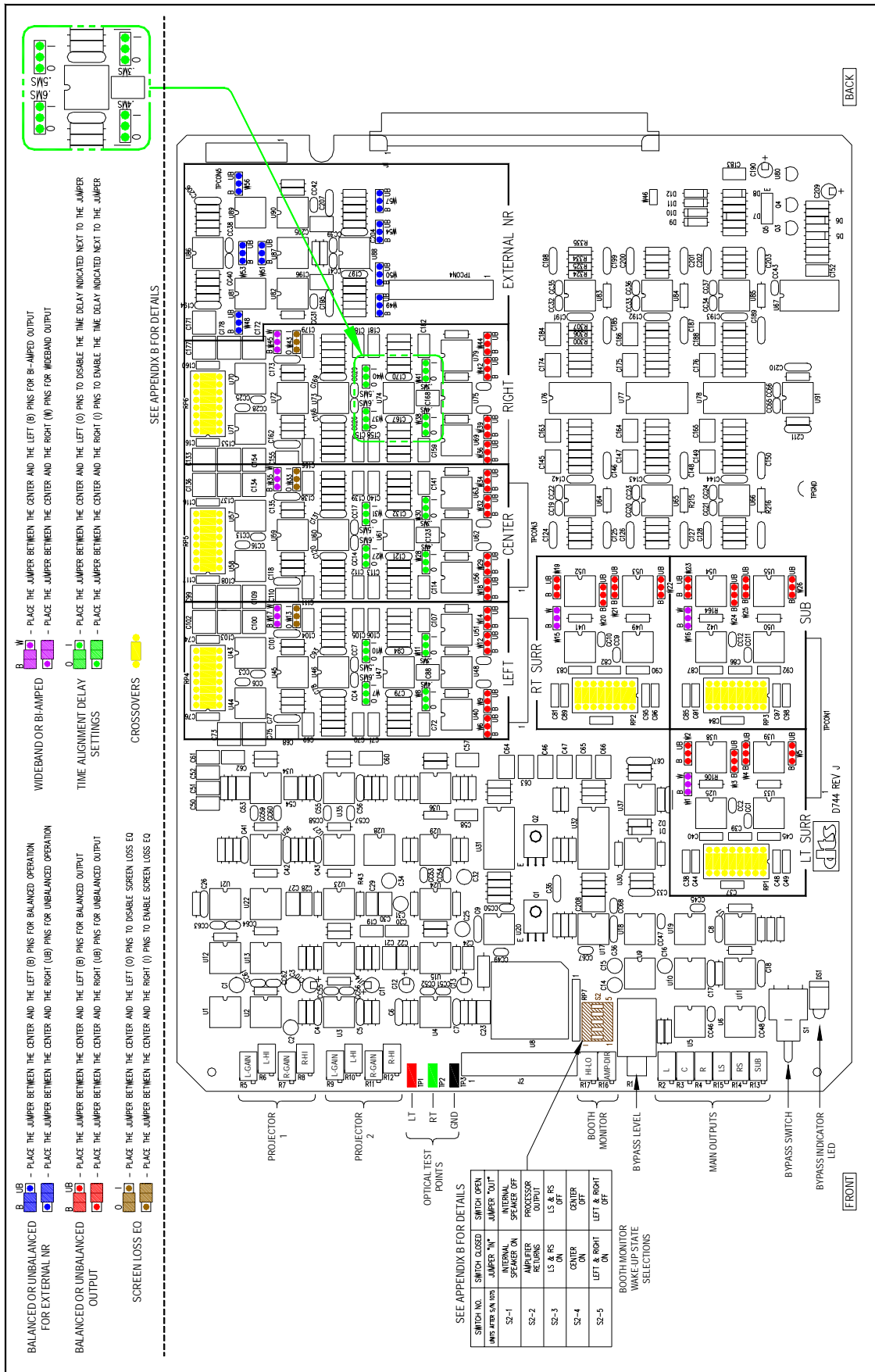

2.4. AUXILARY DC POWER SUPPLY CONNECTION

A separate DIN connector is available for emergency power. A backup supply is highly recommended for failsafe operation. The BYPASS circuits on the D744 board require voltage of +12 VDC *and* -12 VDC to operate. If the internal power supplies fail, an external DC supply that has both positive and negative output is required. It connects to the rear panel AUX POWER P7A via a 3-pin DIN connector.

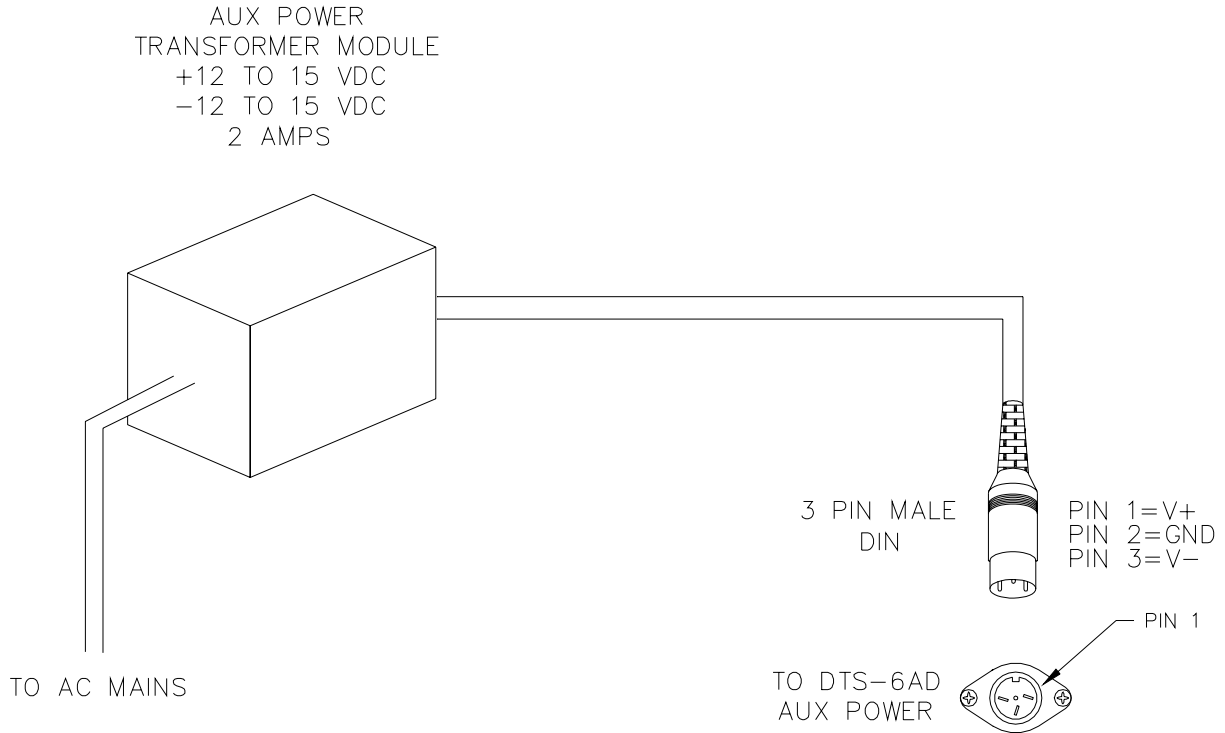

2.5 ADJUSTING CONTRAST ON THE DISPLAY

The contrast on the display screen may be adjusted by a trim-pot located on the side of the display panel. Remove the display as shown on page 2-4. Adjust the trim-pot until the display is easily read when mounted on the front panel.

2.6. INTERFACING TO OTHER SOUND SYSTEMS/SOURCES (see WDE237, Section 10)

Automation Interfacing

At the present time, only the “STATUS/CONTROL” connectors are available for interfacing to automation systems.

External 6-Track Analog Source

The 6-TRACK ANALOG IN connector, P8, on the back of the DTS-6AD, can receive any 300mV 50% modulation (85dB) analog sound source. Most common sources are from 6-track magnetic print masters, other digital sound systems, and external microphones (via a mic preamplifier).

Reference input level is **300mV** (each channel). The DTS-6AD master fader on the front panel controls overall playback volume. There is no individual channel level adjustment for “EXTERNAL”. Front panel **key F5** (EXTERNAL) controls access to this sound source.

Dolby™ Model DA-20

The Dolby Model DA-20 is used to supply the Dolby Digital™ sound track to the DTS-6AD. The DA-20 audio output connects to the DTS-6AD “6-TRACK ANALOG IN”, P8, connector. Its sense control connects to one of the DTS-6AD “STATUS/CONTROL”, P15/16, connectors.

The DA-20 sense circuit requires that a rotary switch (in the DA-20) be set so that the DTS-6AD will automatically switch to the sound format key used to access the Dolby Digital™ input at P8. In the DTS-6AD, this is normally **key F5** (EXTERNAL).

- In the DA-20, set the top rotary switch on the Cat. 611A “Cinema Processor Interface Card” to setting 6 (CP45/65/500 Auto Digital Disabled). This is true for DA-20 units using new software. This will allow the Dolby Digital™ sound track to automatically switch in & out.
NOTE: DA-20 units with old software, should set rotary switch to setting 2 (CP45/65/500 Auto Digital).
- Set up the DA-20 using instructions in the DA-20 Manual. Use “Dolby Digital Test Film” to test its operation with the DTS-6AD.
- See “External 6-Track Analog Source”, above, for more details.

External Crossovers

The DTS-6AD allows the use of external crossovers. When used, the D744 channel jumpers are set for WIDEBAND, the crossover headers are open, and only the HF in/outputs are used.

Internal Crossovers

If internal crossovers are used, verify the value of the D744 crossover header resistors are appropriate for the crossover frequency required by your speaker’s manufacturer. The D744 channel jumpers should be set for **BI-AMPED**. NOTE: If the jumpers are set for WIDEBAND, the speaker’s high frequency drivers may be compromised.

-continued-

2.6. INTERFACING TO OTHER SOUND SYSTEMS/SOURCES (continued)

Remote Fader

A remote fader may be used to control the DTS6-AD overall playback sound. See SDE238 in Section 10 for circuit details. Once remote fader enabled (through MENU), the front panel master fader no longer controls volume.

Auxiliary Monitor Speaker

A self-powered amplified speaker can be used as an external monitor speaker. When connected, it is always active. The MONITOR buttons control which channels are listened to and the sound source: From the amplifier or at the DTS-6AD output. For amplifier output, switch in the "AMPS" button. For the DTS-6AD output, the "AMPS" button should be off.

Digital Amplifiers

The SPDIF connectors: P25, P26, and P27 are used with digital amplifiers and speakers.

Digital Automation – future

External Microphone

An external microphone will require the use of a microphone preamplifier that delivers an output of 300mV. The output of the preamplifier may be fed into P6 = EXTERNAL NOISE REDUCITON, P8 = 6-TRACK ANALOG IN, or, P9A/B = NONSYNC L/R. The master fader on the front panel controls playback volume. The rear panel connectors have front panel format key controls:

- **P8 uses key F5** (EXTERNAL)
- **P9A/B uses key F7** (NONSYNC)
- **P6, key F1** can be programmed to EXTERNAL NR (see "EXTERNAL NOISE REDUCTION", this page, for programming details).

NONSYNC

A NONSYNC stereo source of 300mV such as a CD or tape machine may be used on the DTS-6AD at P9A/B = NONSYNC L/R. Both connectors should be used. The control of the NONSYNC output is **controlled by format key F7**. The master fader on the front panel controls playback volume.

NONSYNC signal routing to the surrounds is available via MENU → SYSTEM SETUP → OPTIONS → (press "NEXT" button 3 times) NONSYNC OUTPUT MODE. Use F3 & F4 ↑ ↓ keys to select setting. Once selected, press OK to save selection. Selections are are:

- Screen NONSYNC L heard screen left, NONSYNC R heard screen right
- Surround NONSYNC L heard in left surround, NONSYNC R heard in right surround
- Screen and surround NONSYNC L heard screen left and left surround, and NONSYNC R heard screen right and right surround.
- Matrix NONSYNC L and NONSYNC R signals are fed through the DTS-6AD's matrix decoder to derive left, center, right and surround channel outputs. This mode should be used to playback material that has been matrix (surround) encoded such as video tapes.

-continued-

2.6. INTERFACING TO OTHER SOUND SYSTEMS/SOURCES (continued)

External Noise Reduction

External Noise Reduction may be used for stereo or Lt/Rt signals. The EXTERNAL NOISE REDUCITON connection, P6, is selectable for balanced or unbalanced on the D744 via programming jumpers. It can be fed into an external NR unit or be used with another Lt/Rt signal from a magnetic sound print master. Matrix may be disabled through MENU (see Section 8.4.1.)

Key **F1** can be programmed to control the output of **P6**, MENU → SYSTEM SETUP → OPTIONS → ASSIGN F1 KEY FORMAT. Use F3 & F4 ↑ ↓ keys to select “EXTERNAL NOISE REDUCITON”. Be sure to save setting. Notice front display now shows F1 as “EXTERNAL NR”.

2.7. POWERING THE DTS-6AD, BOOT-UP SEQUENCE.

Once the DTS-6AD is completely connected to the automation and sound systems, the power switch may be enabled. Once powered, the unit will progress through a boot-up sequence. If all systems are functional, the sequence will proceed as shown below.

The booth monitor “wake-up” state is set by a dip switches on the D744 board. See Page 2-7. If the internal speaker does not enable or none/some of the AMP buttons enable, check the dip switch settings.

All the display LEDs will briefly illuminate, the BYPASS mode will enable, the internal speaker will enable, and the drives will be checked. Screen will display (factory setting is presumed):

<p>And then,</p>	<p>DTS-6AD BOOT V__ Self test...__</p>	<p>⇐ displays firmware version in unit ⇐ if passes, will display “OK”</p>								
<p>And then,</p>	<p>DTS-6AD BOOT V1.00 Self test...OK <FMT> Install Program</p>	<p>⇐ showing V1.00 as firmware version</p>								
<p>And then,</p>	<p>DTS logo Characterizing PLL.</p>									
<p>And then,</p>	<p>DTS logo Initializing DSP.</p>									
<p>And finally,</p>	<table border="0" style="width: 100%;"> <tr> <td style="width: 33%;"><u>< MONO</u></td> <td style="width: 33%; text-align: right;">EXTERNAL ></td> </tr> <tr> <td style="width: 33%;"><u>< A</u></td> <td style="width: 33%; text-align: right;">◎ DIGITAL</td> </tr> <tr> <td style="width: 33%;"><u>< SR</u></td> <td style="width: 33%; text-align: right;">NONSYNC ></td> </tr> <tr> <td style="width: 33%;">Time and day</td> <td style="width: 33%; text-align: right; font-size: 2em;">7 0</td> </tr> </table>	<u>< MONO</u>	EXTERNAL >	<u>< A</u>	◎ DIGITAL	<u>< SR</u>	NONSYNC >	Time and day	7 0	<p>⇐ Normal Operating Screen</p>
<u>< MONO</u>	EXTERNAL >									
<u>< A</u>	◎ DIGITAL									
<u>< SR</u>	NONSYNC >									
Time and day	7 0									

The internal speaker will remain enabled. The left, center, right AMP buttons will enable. Time and day programmed through software MENU, see Section 4.2 “CLOCK”. Firmware version reflects what is installed in unit.

SECTION 3 FRONT PANEL

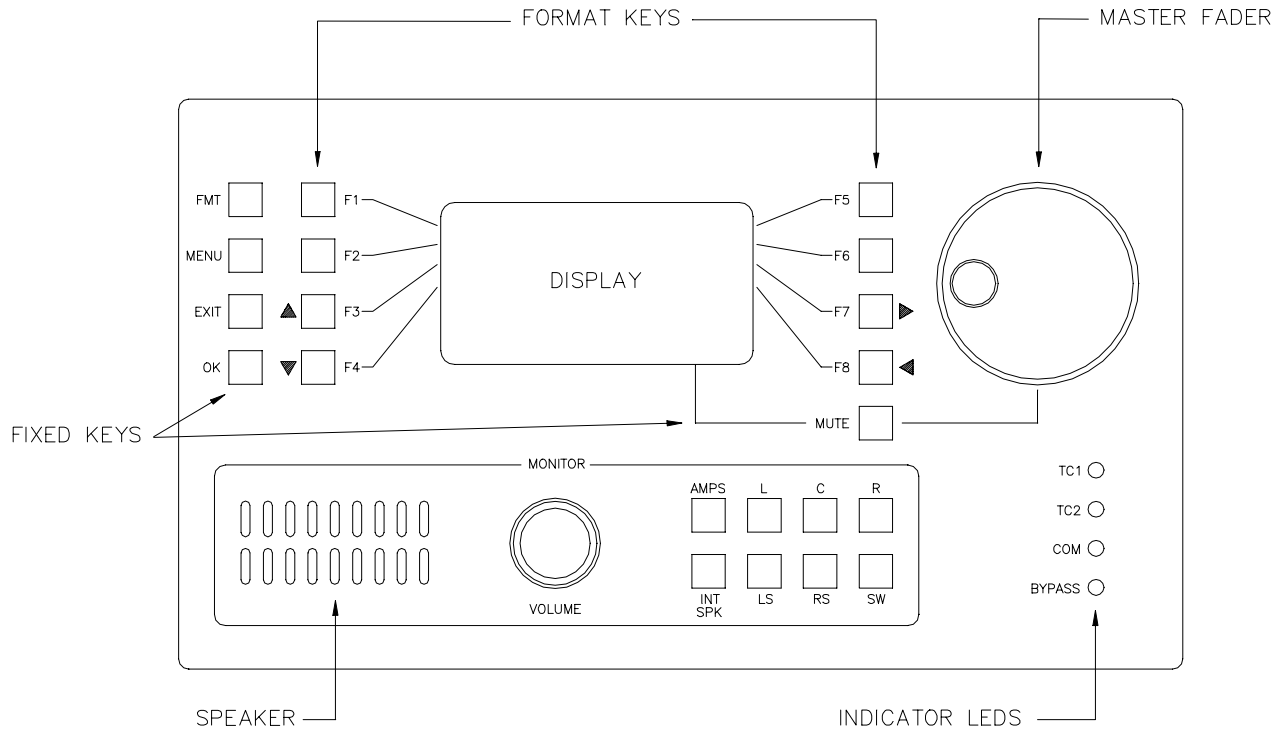

DTS-6AD FRONT PANEL

3.1. DTS-6AD FRONT PANEL

On the front panel of the DTS-6AD, there are groupings of fixed and soft (software programmable) keys, master fader, display, indicator LEDs, and the booth monitor including monitor volume and selector switches. The fixed keys always perform the function indicated. Soft keys, on the other hand, may be changed to operate various sound formats.

3.2. FIXED KEYS

The fixed keys are:

- FMT > returns user to main operation screen
- MENU > enters user into programming menu
- EXIT > exits user back one programming step
- OK > saves user programmed selections
- MUTE > mutes volume

3.3. (BOOTH) MONITOR KEYS

These fixed keys are:

- AMPS > when enabled, selects listening from the amplifiers. When disabled, selects listening from the output of the DTS-6AD.
- L > selects listening to the left channel
- C > selects listening to the center channel
- R > selects listening to the right channel
- INT SPK > when enabled, selects listening through the internal speaker.
- LS > selects listening to the left surround channel
- RS > selects listening to the right surround channel
- SW > selects listening to the subwoofer channel

3.4. SOFT (FORMAT) KEYS

The soft keys are F1 through F8. These keys are user programmable sound format selections. The factory default format settings are:

- *F1 > MONO
- F2 > A-TYPE
- F3 > SR
- F5 > EXTERNAL (external 6-track input)
- F6 > (DTS) DIGITAL
- F7 > NON-SYNC

* At this time, only the F1 key is user reprogrammed. To reprogram F1, press MENU → SYSTEM SETUP → OPTIONS the optional functions may be scrolled by pressing F3 & F4 ↑ ↓ keys. To keep selection, press OK key twice.

Continue in the programming menu by pressing the EXIT key, or, return to the main operating screen by pressing the FMT key. The F1 key should reflect user selection.

SECTION 4 DTS-6AD INITIAL SETTINGS

All tests contained in this section must be completed before proceeding to B-chain adjustment.

4.1. SETUP CHECK LIST

Use this checklist to ensure important settings are completed before showing film to an audience.

COMPLETED

- Verify wiring and cable routing (Section 10)
- Set D744 board jumpers (Section 2.4)
- Program internal clock (Section 4.2)
- Surround delay calculated and programmed (Section 4.3)
- Speaker Time Alignment Delay calculated and programmed (Section 4.4)
- Theater equipment check (Section 4.5)
- Set preliminary level settings (Section 4.6)
- Speaker Phase checked (Section 4.7)
- B-chain alignment completed (Section 5)
- All audio settings are saved in a LOAD/STORE file (Section 5.2.4)
- A-chain alignment completed (Section 6)
- F1 key assigned a sound format (Section 8.3.2)
- Timecode reader offset (delay) calculated & programmed (Section 7.3)
- Program NONSYNC output mode (Section 8.3.3)
- Program default format (Section 8.3.4)
- Program password, if desired (Section 8.3.1)
- Program sound format trims, if needed (Section 8.4.3)
- Performance test (Section 9)
- (Booth) monitor performance and default verified (Section 9.1.1)
- BYPASS operation verified (Section 9.1.1)
- Automation verified with DTS-6AD (Section 9.1.2)

4.2. CLOCK

This is not only a convenience but is also used to identify audio setup files. The clock should be set before any audio programming is done. To program the internal clock, press MENU → SET CLOCK. The following screen should appear:

<SET HOUR
TIME: _____
DAY: _____
DATE: _____

To set time, hold down F1 SET HOUR and turn master fader until the current hour is achieved. Once set, press F7 → and turn master fader to set minutes. Once selected, press F7 → and turn master fader to set seconds. Continue through settings: Press F7 → and turn the master fader to set AM or PM, day, month, and year. Settings are displayed and may be scrolled through using F7 & F8 ← →. Once finished, press OK twice to save settings. To return to the normal operating screen, press FMT button.

Once the normal operating screen appears, the programmed **time & day** should appear on the screen bottom.

< MONO	EXTERNAL >
< A	⊙ DIGITAL
< SR	P1 - P2 NONSYNC >
Time & day	7 0

← Normal Operating Screen

↑
Clock setting

4.3. SURROUND DELAY

This is used to ensure the sound from the back of the theater arrives at the listener's ears approximately 20 milliseconds after the arrival of the front speaker sound. The following procedure describes how to arrive at the correct surround delay setting.

- Measure the distance between a **rear seat** and the nearest **surround speaker** in feet. If calculating in metric, convert feet to meters by multiplying by 3.
- Measure the distance from the **same rear seat** to the nearest **screen speaker**. If calculating in metric, convert feet to meters by multiplying by 3.
- Subtract the distances measured from each other, and add 20. The result is **the surround delay in milliseconds**.

EXAMPLE: Rear seat is 12 feet from nearest surround speaker

Rear seat is 82 feet from nearest screen speaker

The surround delay is set for $(12 - 82) + 20 = 90$ milliseconds

- Program result into DTS-6AD by pressing MENU → SETUP → AUDIO → SURROUND DELAY. The screen below should appear:

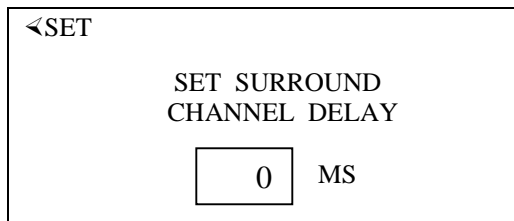

- Set value by pressing F3 & F4 $\uparrow \downarrow$ or hold down F1 SET and turn master fader. Delay setting selections are in increments of 10. The maximum setting is 100ms.
- Once the setting is complete, press OK twice to save.
- Verify surround delay setting by listening to a familiar soundtrack or the DTS BUZZ AND BILL SHOW Test Film. The action on-screen should match sound in the auditorium. Most soundtrack mixers use the surrounds sparingly or to evoke spaciousness. Generally, no screen dialogue should be heard in the surrounds, and if there is, the delay setting is probably too high.

4.4. (SPEAKER) TIME ALIGNMENT DELAY

This is used to delay the low frequency sound in screen speakers. It's done to compensate for time discrepancies between low and high frequencies that are caused by the low frequency drivers being in front of high frequency drivers in common screen speakers. Sound from low frequency drivers must be delayed so the low frequency energy and high frequency energy reaches the listener at the same time. Check with speaker manufacturer for delay specifications.

Jumpers on the D744 board are used to set the delay. The jumpers program time delay in increments of 0.3, 0.4, 0.5, and 0.6 milliseconds. A jumper can be used alone or several added together, depending on the delay required. Page 2-7 shows the location of delay jumpers for each screen channel.

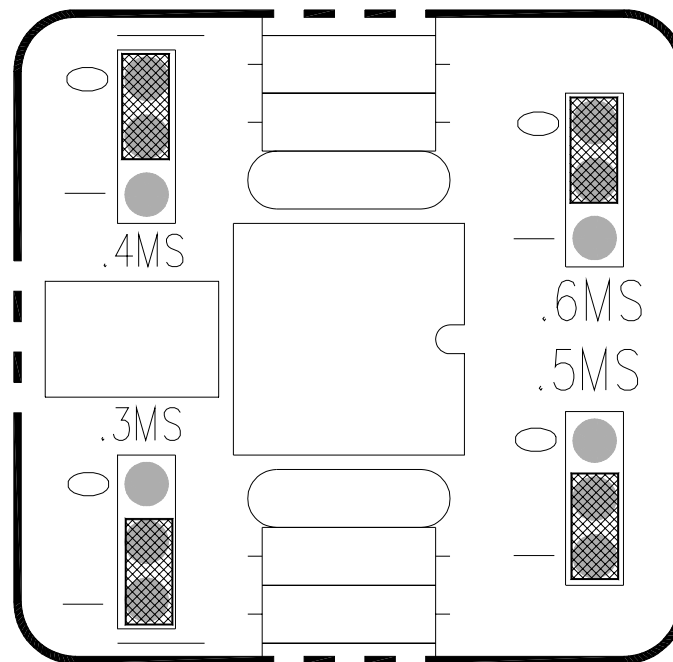

1 = In
0 = Out

EXAMPLE: A speaker manufacturer specifies a delay of **0.8 ms**. On the D744, set (2-position) jumpers “0.3ms” and “0.5ms” to the “1” & center position. This sets the delay: $0.3\text{ms} + 0.5\text{ms} = 0.8\text{ms}$.

If **no delay** is needed, set each screen delay jumper to “0” & center position.

4.5. THEATER EQUIPMENT CHECK

Prior to adjusting the EQ, all of the components in the audio system should be checked for proper installation and operation.

SPEAKERS

- Check that all speakers are properly mounted and secured. Ensure there are no loose parts or mounting hardware left around the speakers that could be a source of noise or rattles.
- Check the aiming of all speakers. Verify there are no obstructions in front of the speakers. For stage channels, ensure that the masking, screen frame, and sound wall do not block the speakers.
- Speaker cables should be correctly secured to the speakers and are of a suitable gauge.
- Verify each speaker has no missing or open drivers.
- Check that all speakers are connected to the correct channel.
- Verify the high and low frequency drivers for each channel are in phase. Also check each channel is in phase with the others.

AMPLIFIERS

- The gain settings of all of the screen channel amplifiers and surround amplifiers should be the same. If a particular amplifier requires a vastly different gain setting or operates differently than the others, then it should be checked and repaired.
- Check all of the amplifiers for distortion or noise.
- Verify that the cooling fans are operating correctly and that the air vents are clean and free from obstructions.

AUDITORIUM

The auditorium should have all of the acoustic treatments installed prior to setting the EQ. Any excessive noise from air conditioners, hallways or other sources should be minimized. All chairs must be installed. Remove any plastic coverings from chairs or speakers prior to any EQ (B-chain) alignment.

4.6. SET PRELIMINARY OUTPUT LEVELS

The DTS-6AD output levels are factory preset at 250mV rms. This nominal level ensures that speakers will not be overdriven during the setup procedure. All SPL readings must be taken in the theater, just off-center in rear third section.

Most installers set the speaker amplifier gain(s) to maximum. In some situations, this may cause excess noise from the amplifier. If this is the case, then the amplifier gain should be reduced to an acceptable level. That setting should be clearly marked so it can be reset, if necessary.

- Set master fader to 7.0.
- Place SPL meter in theater (rear third section, just off center). Set SPL meter to C weighted, slow. From the Level Adjustment Screen, enable the internal pink noise generator. If starting from main operation screen, press MENU → SYSTEM SETUP → LEVEL.

Press **F6 P** to enable pink noise. Should be heard in theater & monitor, on left channel only.

Pink noise will remain on until it is turned off by pressing F6 again or by pressing EXIT button.

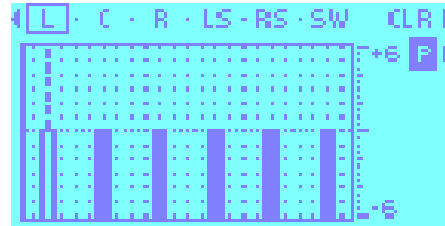

Measure SPL. Adjust **L** (left) channel (“Main Outputs”) gain trimpot, on the D744 analog board, to obtain **80 dBC**. NOTE: After EQ is finished, final SPL will be set as in Section 5.

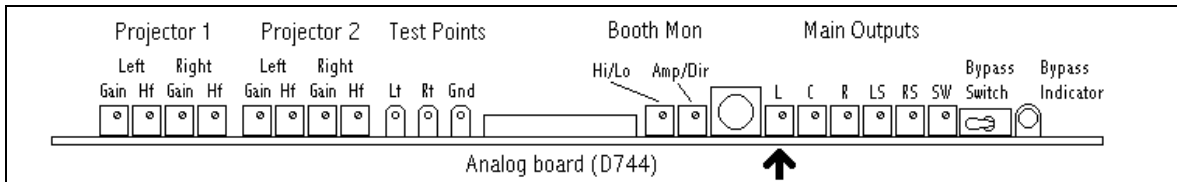

- Once set, proceed to **C** (center) channel and adjust it to 80 dBC. Repeat for remaining channels.

Press **F7 →** to advance to the next channel.

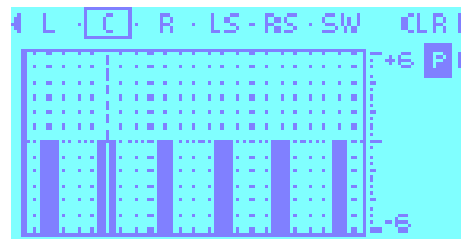

- After all channels are set to 80 dBC, press OK. To return to the normal operating screen, press FMT button. To proceed to room EQ, press F1, ROOM EQ Menu (go to Section 4.3).

4.7. (SPEAKER) PHASE

Tools required: SPL meter & phase checker device (if surround channels use an array of speakers).

Speaker Phase must be tested to verify adjacent speakers are in-phase. If speakers are not in-phase, signals will cancel and playback will never sound correct. Speaker phase is tested by first playing pink noise on one channel and measuring SPL output. Then, pink noise is also played on the adjacent channel. SPL should increase. If SPL decreases, speakers are not in-phase.

The Phase Screen allows the user to play pink noise on several channels at once and, if desired, to invert the phase for each individual channel. This screen is used for testing only, if phase is inverted while testing, it will not effect soundtrack playback.

To test, place SPL meter in auditorium as shown on page 5-1. Now, enter the Phase Screen: Press MENU → SYSTEM SETUP → AUDIO → PHASE. The screen below should appear:

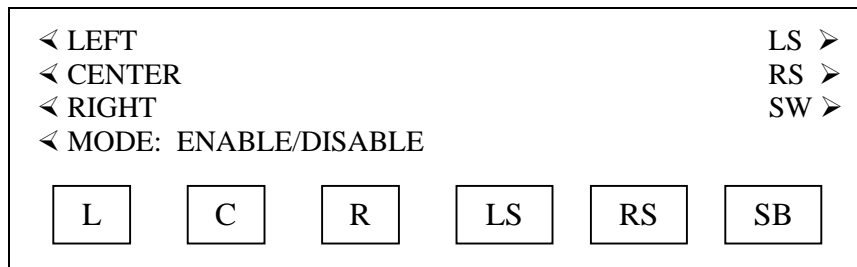

- First, test **Screen Speakers**. Press F1 LEFT . The “L” box should highlight. Pink noise from the left channel should be heard in the auditorium and booth monitor. Note SPL reading. Now, press F2 CENTER . Both the “L” and “C” boxes should highlight and the SPL should increase. If the level goes down, the speakers are out-of-phase.

To verify speakers suspected of being out-of-phase:

- Leave both “L” and “C” boxes highlighted, and continue monitoring SPL
- Press F4 so that the “MODE” changes to “INVERT PHASE “
- Press F2 CENTER so that “INV” appears under the “C” box
- The phase for center channel pink noise has now been inverted
- If SPL increases, this verifies that the center speaker is **NOT** in phase with the left speaker.

NOTE: MODE can be returned to “ENABLE/DISABLE” by pressing F4.

If speakers are out-of-phase, check speaker wiring. If external wiring incorrect, fix and retest phasing. It is possible, although rare, that speakers are internally cross-wired. In this case, swap wires on the output of the speaker and check phase again. If that fixes it, leave external wires crossed – leave a note or label for the service technician.

- Repeat test for CENTER and RIGHT screen speakers.
- Now, test **surround speakers**. If only one speaker is used for each surround channel, perform the Screen Speakers Test, above. If an array of speakers is used for each surround channel, use a phase checker device that allows testing of each individual surround speaker. The DTS-6AD Phase Screen cannot do this type of testing.

NOTES

Thank you for choosing DTS !

SECTION 5 B-CHAIN ALIGNMENT

This procedure was written with the assumption that the installer is familiar with the fundamentals of installing and equalizing cinema processors, and the use of microphone multiplexers. **The DTS-6AD clock, surround delay, speaker time alignment delay, and speaker phasing must be completed before proceeding.**

The following equipment is required:

- SPL meter
- Real Time Analyzer
- Calibrated Microphone or Mic Multiplexer
- DTS Technician's kit

Place Multiplexer in auditorium as directed by manufacturer. Or, see diagram below.

SUGGESTED MICROPHONE PLACEMENT

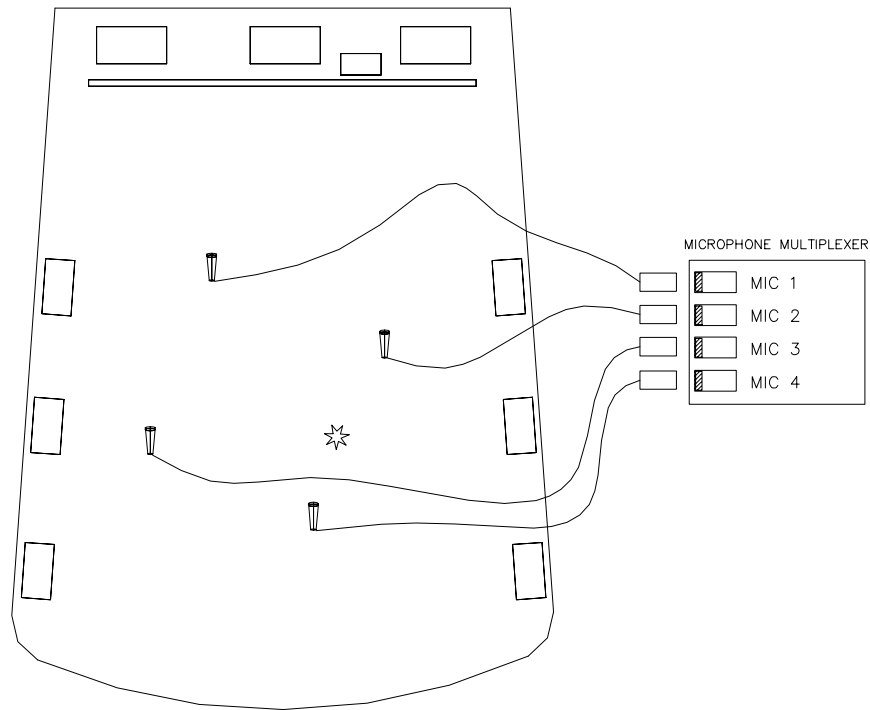

★ MAKE ALL SPL READINGS AT THIS LOCATION.
IF USING A SINGLE CALIBRATED MICROPHONE FOR
ADJUSTING EQ, LOCATE THE MIC AT THIS LOCATION.

THEATER.DWG

5.1. SETTING OUTPUT LEVELS

5.1.1. CONNECTING A MICROPHONE OR MIC MULTIPLEXER:

At this time, the DTS-6AD built-in RTA and AUTO-EQ features are not implemented. So, an external multiplexer system is required. The EQ settings are adjusted by means of on-screen menus. Place microphones in theater as directed by the manufacturer of multiplexer, or, as per the suggested microphone placement drawing (page 5-1).

5.1.2. CHECK DTS-6AD PROGRAMMED OUTPUT LEVELS

Press MENU → SYSTEM SETUP. The Main Menu should be displayed:

Main Menu ➤

Press F1, SYSTEM SETUP, to enter System Setup Menu



System Setup Menu ➤

Press F1, AUDIO, to enter Audio Setup Menu

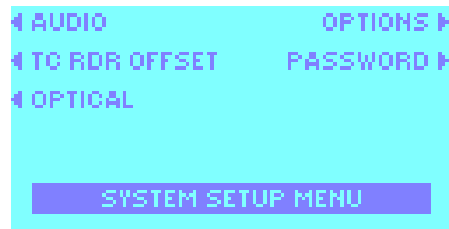

Audio Setup Menu ➤

Press F2, LEVEL, to enter Level Adjustment Screen

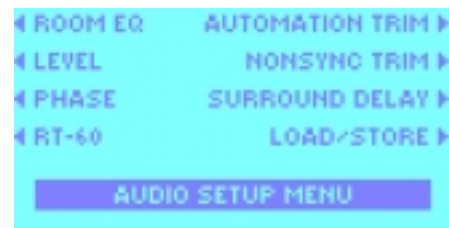

Level Adjustment Screen ➤

Level for each channel should be on the center line, as shown.

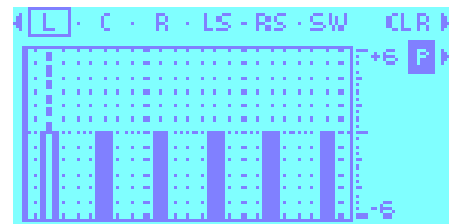

If the channels are not equal, make the necessary corrections. Use F7 & F8 keys ← → to select channel. Use F3 & F4 keys ↑ ↓ to adjust level.

5.1.3. MEASURE PRELIMINARY OUTPUT LEVELS

The DTS-6AD output levels are factory preset at 250mV rms. This nominal level ensures that speakers will not be overdriven during the setup procedure. All SPL readings must be taken in the theater, just off-center in rear third section.

- Set master fader to 7.0.
- Place SPL meter in theater (rear third section, just off center). From the Level Adjustment Screen, enable the internal pink noise generator. If starting from main operation screen, press MENU → SYSTEM SETUP → LEVEL. The screen below should appear:

Press **F6 P** to enable pink noise. Should be heard in theater & monitor, on left channel only.

Pink noise will remain on until it is turned off by pressing F6 again or by pressing EXIT button.

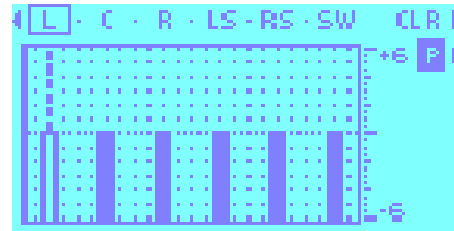

Measure SPL. Adjust **L** (left) channel (“Main Outputs”) gain trimpot, on the D744 analog board, to obtain **80 dBC**. NOTE: After EQ is finished, final SPL will be set.

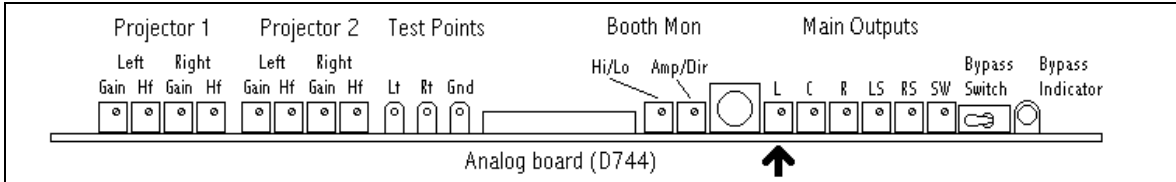

- Once set, proceed to **C** (center) channel and adjust it to 80 dBC. Repeat for remaining channels.

Press **F7 →** to advance to the next channel.

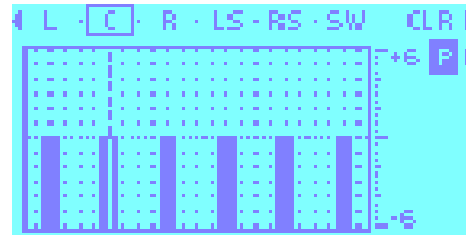

- After all channels are set to 80 dBC, press OK. To return to the normal operating screen, press FMT button. To proceed to room EQ, press F1, ROOM EQ Menu.

5.2. ROOM EQUALIZATION

A microphone multiplexer (or single mic) and RTA are required to perform room EQ. Place microphones as per RTA manual, or see Suggested Microphone Placement drawing, page 5-1.

While observing the display on the RTA, cycle through the pink noise for each channel. The left, center, and right channels should be similar to each other. The display for the surrounds will be different than the screen channels, although both left and right surround channels should look similar to each other. If there are large differences between the channels with all the EQ adjustments set to flat, then there may be a problem with the speakers, speaker phasing, or amplifiers. Make any necessary adjustments or repairs before proceeding.

5.2.1. EQ PROGRAMMING PROCEDURE

- Start by pressing MENU → SYSTEM SETUP → AUDIO, the Audio Setup Menu should display:

Audio Setup Menu ➤

Press F1, ROOM EQ, to enter ROOM EQ Menu



Room EQ Menu ➤

Press F1, LEFT, to start left channel EQ

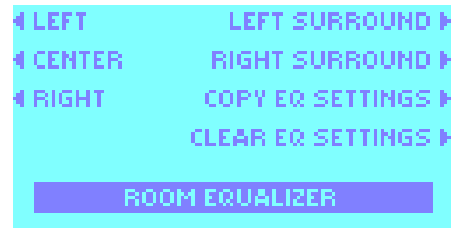

If the fader is already set to 7.0, this dialog box will not be displayed. ➤



- Press OK to set fader to 7.0 **All adjustments should be done with master fader set to 7.0.**

Press OK to enable internal pink noise generator

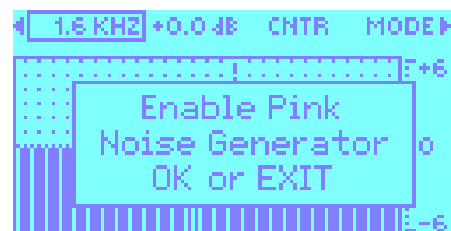

-continued-

5.2.1. EQ PROGRAMMING PROCEDURE (continued)

1/3 Octave Adjustment Screen ➤

Pink noise should be heard in theater & monitor, coming from **left** channel only.

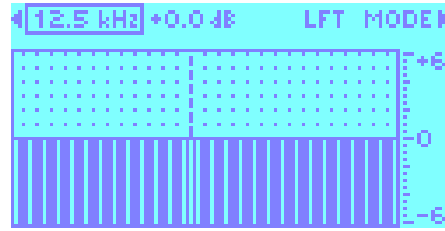

- Press F5 to advance to **BASS** adjust. Press **↑ ↓** -or- hold down F1 and turn master fader to adjust BASS signal. Adjust BASS frequency response as flat as possible (as displayed on RTA).
- Press F5 again to advance to **TREBLE** adjust. Press **↑ ↓** -or- hold down F1 and turn master fader to adjust TREBLE signal. Adjust TREBLE to achieve a flat response to 2 kHz with the level dropping off 3 dB per octave above 2 kHz (on RTA, see below X-curve sample drawing).
- Press F5 again to advance to the **1/3 octave adjustment** screen (left channel). The screen will look like last one above. At this point, the EQ can be fine-tuned by selecting a frequency using F7 & F8 keys **← →** to scroll across the screen -or- the master fader can be rotated to select desired **frequency band**.
- Once the frequency band is selected, the level can be adjusted by using the F3 & F4 keys **↑ ↓** Or, holding down F1 and turning master fader will also increase/decrease **frequency level**.
 - Each of the 27 bands on the equalizer can be adjusted from -6dB to +6dB in 1/2 dB increments.
 - The goal is to achieve the standard X-curve (see below) with a flat response to 2 kHz and a roll-off of 3 dB per octave above 2 kHz, as described in ISO Standard 2969, using as little EQ as possible (see RTA pattern, below). Diametrically opposed settings on adjacent frequencies bands should be avoided. Adjustments on one frequency band will affect the adjacent bands so adjustments should be made in small increments. When one band is set, often, a slight correction on an adjacent band will be required to maintain the correct response.

Standard X-curve
RTA

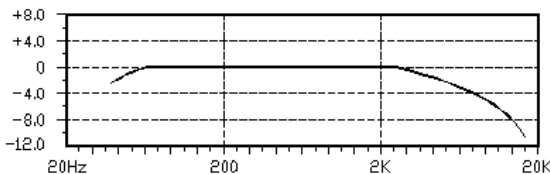

Make adjustments on DTS6AD screen ➤ to achieve X-curve on ◀ RTA.

1/3 Octave Adjustment Screen
DTS6AD

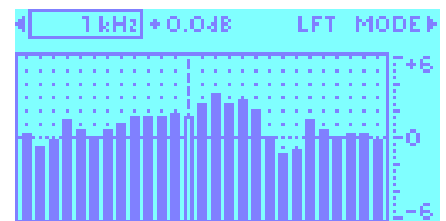

- When the left channel is complete, press the OK button to move to the next channel. The screen will ask if the current settings should be kept. Press the OK button to **save settings**. Once saved, hit OK to proceed to the next channel – that happens to be the **CENTER** channel. Repeat steps for all remaining channels. To return to the normal operating screen, press FMT button.

5.2.2. COPYING EQ SETTINGS

Copying EQ settings from one channel to another speeds the EQ process. Screen channels may be copied to screen channels, and surround channel to surround channel. However, screen channels cannot be copied to surrounds.

- To copy settings, enter ROOM EQ Menu (MENU → SYSTEM SETUP → AUDIO → ROOM EQ)

ROOM EQ Menu ➤

Press F7 COPY EQ SETTINGS

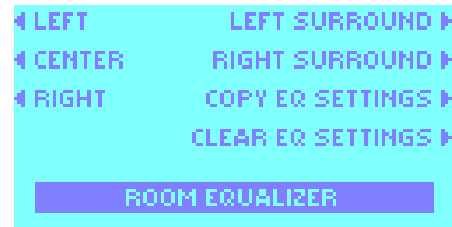

FROM *** TO Screen ➤



- Channel EQ settings may now be copied from one channel to another. Press F3 & F4 keys ↑ ↓ to select “FROM” channel, or, hold down F1 “SELECT CHANNEL” and turn master fader.
- Select “TO” channel by pressing F7 & F8 keys ← → Press F3 & F4 keys ↑ ↓ to select desired channel, or, hold down F1 “SELECT CHANNEL” and turn master fader.
- Once set, press F5 BEGIN COPY.

Confirm Screen ➤

Press OK button to save

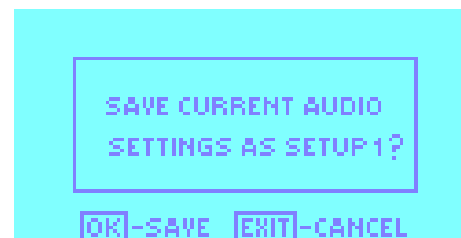

- Press OK button again to return to Room EQ Menu. Proceed to the channel that the copied settings were sent. Fine-tune that channel’s EQ as needed.

5.2.3. SURROUND EQ AND SUBWOOFER CHANNEL

The **surround channel** equalizers differ from the screen channels in that they have single octave bands instead of 1/3 octave bands. There is no EQ screen for **subwoofer**.

- Enter ROOM EQ Menu (MENU → SYSTEM SETUP → AUDIO → ROOM EQ). Press F5 LEFT SURROUND. Press OK to enable internal pink noise. The screen below should appear:

Single octave adjustment screen ➤

Pink noise should be heard in theater & monitor, coming from **left surround** channel only.

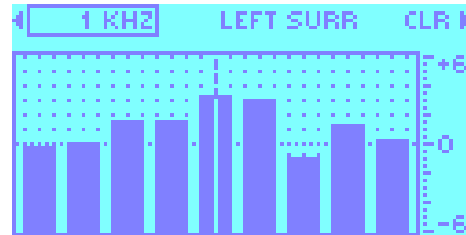

- Once the settings for all channels have been saved in current memory, press EXIT several times and return to the AUDIO Setup Menu. Save EQ settings in a STORE file.

5.2.4. LOAD / STORE PROCEDURE

The Load/Store feature is used when moving the same DTS-6AD from one theater to another, and then back again. The EQ settings can be saved in up to two setup files. Save Audio Setup for one theater in one file and the setup for another other theater in the second file.

- Finish Audio Setup for all channels. To **store** setup, press MENU → SYSTEM SETUP → AUDIO. The screen below should appear:

AUDIO Setup Menu ➤

Press F8 to enter LOAD / STORE Screen



LOAD/STORE Screen ➤



- Press F1 to **store** the current configuration as **Setup #1**. (If an additional setup is desired, go back to the AUDIO Setup Menu and start the Audio Setup, starting at Section 5.2.1, process again. Remember, this time, to store settings in Setup #2.)
- Press OK to confirm saving the setup. Press FMT to return to normal operating screen.

-continued-

5.2.4. LOAD / STORE PROCEDURE (continued)

- To **load** Audio Setup settings, press MENU → SYSTEM SETUP → AUDIO, the screen below should appear:

AUDIO Setup Menu ➤

Press F8 to enter LOAD / STORE Screen



LOAD/STORE screen ➤



- Press F3 to load configuration desired. The screen will show the time and date of selected configuration. If that file desired, press OK to load. The LOAD/STORE Screen will reappear.
- To check the settings entered, press OK button again to enter the AUDIO Setup Menu. The setting may now be checked. Verify all audio settings were indeed loaded.
- Press the FMT button to return to the normal operating screen.

5.2.5. CLEARING EQ SETTINGS

To clear EQ settings from one channel or all channels, press MENU → SYSTEM SETUP → AUDIO → ROOM EQ → CLEAR EQ SETTINGS. Select channel to clear.

CLEAR EQ SETTINGS screen ➤

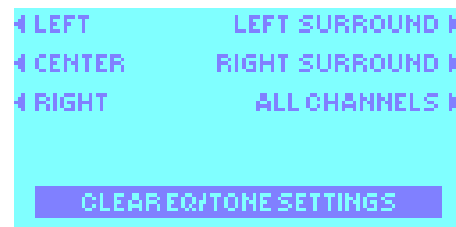

5.3. FINAL SOUND LEVEL ADJUSTMENTS

5.3.1. SPL ADJUSTMENT

- Press MENU → SYSTEM SETUP → AUDIO → ROOM EQ → LEFT → OK (to enable pink noise) .
- If screen displays “Set Master Volume to 7.0”, press OK. **All levels should be set with master fader set to 7.0.**
- The screen will display “Enable Pink Noise Generator?” Press OK and proceed to set SPL for the left channel. Pink noise should be heard in theater & monitor coming out left channel only.

SPL meter set to “slow” and “C” weighted. Adjust D744 “L” (left) channel (“Main Outputs”) trimpot until SPL reads 85 dBC in the theater.

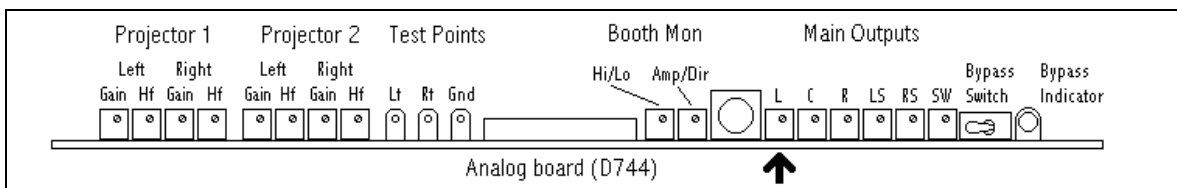

- Once set, press OK to proceed to the center channel. Set D744 (“Main Outputs”) “C” trimpot to achieve 85dBC in the theater.
- Repeat procedure for all channels, set to the following SPLs:

Left, Center, Right	85 dBC
Left & Right Surrounds	82 dBC
Subwoofer	* 85 dBC

*** NOTE:** The above levels are for use with the **internal pink noise generator**. When playing back a DTS Set-up or Empirical Disc, the **subwoofer level** should be 91 dBC. This setting conforms the subwoofer level to the SMPTE RP200 standard of having +10dB in-band gain in relation to the screen channels.

- Press FMT button to return to the normal operating screen.
- RTA (or SPL meter) should remain in theater so digital sound levels can be checked.

5.3.2. CHECKING DTS DIGITAL LEVELS

Insert **DTS Setup Disc**. When the disc is read, the DTS-6AD should automatically switch to F6 ● DIGITAL format. Each channel is announced before pink noise is heard in theater & booth monitor. Press F4 to advance to the next program. The Setup Disc is used to verify levels only. **Levels are set using the internal pink noise generator.**

Verify digital levels:	Left, Center, Right	85 dBC
	Left & Right Surrounds	82 dBC

(digital subwoofer next page)

5.3.3. DTS DIGITAL SURROUND SIGNALS

With the RTA connected, notice a dramatic roll-off at 80Hz. DTS derives the digital subwoofer by filtering out the surround signals from 80Hz and below. This is normal when in the DTS digital format and surround pink noise is playing in the theater.

5.3.4. DTS SUBWOOFER LEVEL

- The most accurate way to measure DTS digital subwoofer level is to use a **RTA**.
- The DTS Setup disc must be used, it supplies digital subwoofer pink noise to the auditorium.
- The DTS digital subwoofer should have **+10dB in-band gain** as compared to the screen channels. The graph below shows the pattern that should be exhibited by the RTA when the (DTS Setup Disc) subwoofer pink noise is playing in the theater.

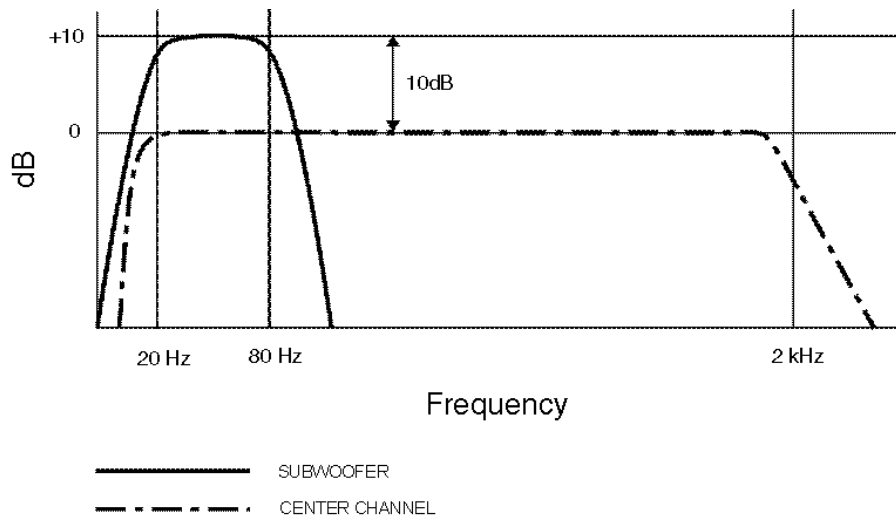

- If a RTA is not available, the **DTS subwoofer** can be measured using a **SPL meter**. The SPL meter must be set for “**C**” **weighting** and “**slow**.” It should read about **91 dBC** when the (DTS Setup Disc) subwoofer pink noise is playing in theater. Take measurements in different areas of the auditorium to prevent subwoofer from being adjusted too loud.

5.3.5 LISTEN TO THEATER SPEAKERS

- After adjusting EQ and SPL, run the internal pink noise generator – or – insert a DTS Setup (or Empirical Test) Disc.
- Walk through the auditorium and listen to the speaker’s sound quality at different locations.
- Verify there is a uniform sound quality throughout the auditorium. If there are large differences from one area to another, the EQ and SPL process should be repeated.

SECTION 6 A – CHAIN ALIGNMENT

6.1. ALIGNING PROJECTOR’S ANALOG OPTICS

This procedure assumes that the sound head alignment is complete and therefore will not fully cover solar cell, exciter lamp, slit lens, or lateral guide adjustments. If the projector’s sound head is not aligned, refer to the projector’s installation manual or contact projector manufacturer.

Equipment Required: Oscilloscope, test leads, DTS technician’s kit, RTA, and test/setup films:

- **50% Modulation Tone**
- **Pink Noise**
- SMPTE BUZZ Track
- 1 kHz Cross-talk Cell Alignment
- P35-SL 1000Hz Signal, “Photographic Sound Track” (MONO), Level SMPTE Test Film (optional).

The 50% Modulation Tone and Pink Noise films are used to setup the DTS-6AD and are mandatory. Use the BUZZ Track and 1 kHz Cross-talk Films to check projector adjustments. The SMPTE MONO Test Film is not essential for setting up the DTS-6AD.

CONNECT TEST EQUIPMENT

Connect the oscilloscope and RTA to the to the DTS-6AD via test inputs on the D744 board. Use test leads that have dual-ended plugs at 0.080 inches long and are 2mm in diameter, such as a Pomona 3901 or 3221.

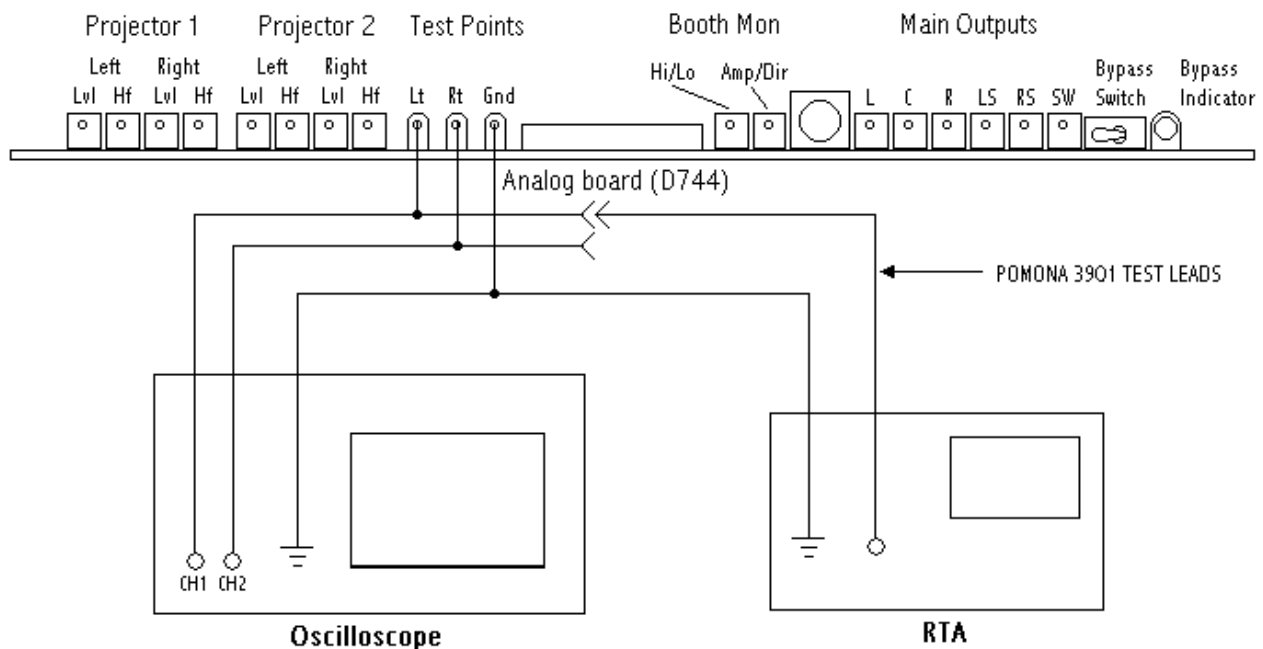

6.2. OPTICAL GAIN (Projector 1)

WARNING: Entering OPTICAL Setup Screen will force the system to reset levels:
 OPTICAL GAIN = 0
 NOISE REDUCTION = OFF
 OUTPUT = MUTE

Do not select this menu while running film with an audience in the auditorium.

- First, verify the projector’s optics have been cleaned and aligned.
- Run the **50% Modulation Tone** film. Press MENU button, the screen below should appear:

Main MENU ➤

Press F1 to select SYSTEM SETUP



SYSTEM SETUP menu ➤

Press F3 to select OPTICAL

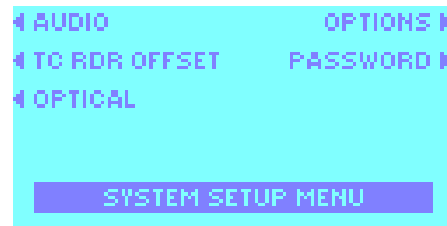

OPTICAL setup screen ➤

MUTE will automatically be activated when OPTICAL is selected.

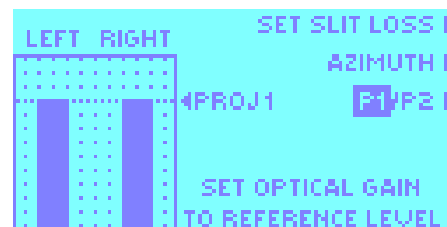

- Note that **P1** should be highlighted and **PROJ 1** displayed to the right of the level meter



-continued-

6.2. OPTICAL GAIN (Projector 1) -continued-

- With the **50% Modulation Tone** film playing, adjust **PROJECTOR 1 LEFT GAIN** trimpot for Projector 1 left cell.

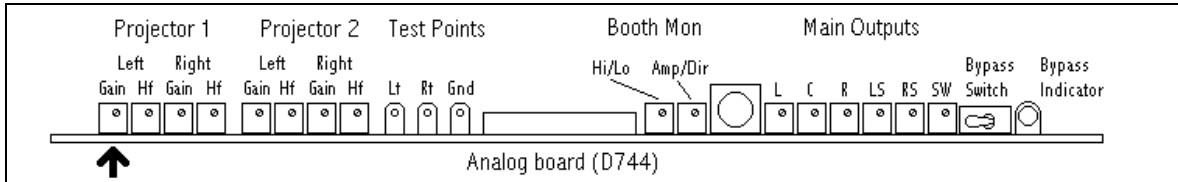

- Adjust trimpot until Projector 1 Left Optical Gain is at reference level, indicated by **←PROJ1** on the OPTICAL setup screen.

OPTICAL setup screen ➤

Adjust LEFT GAIN trimpot until the level is at reference level

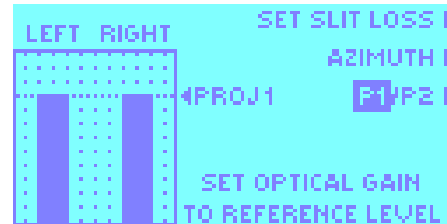

- Adjust the **PROJECTOR 1 RIGHT Gain** trimpot for the right cell in the same manner.

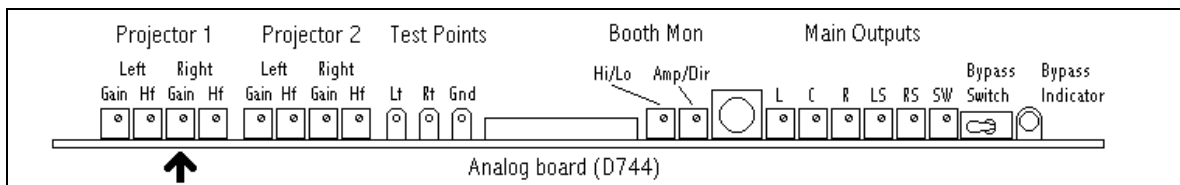

- Continue on to **CELL ALIGNMENT CHECK**.

6.3. CELL ALIGNMENT CHECK (Projector 1)

6.3.1. CELL ALIGNMENT

- Run a loop of **SMPTE Buzz Track** film. Check for proper lateral alignment of the solar cell. The (cell) slit must be properly aligned so that the light illuminates only the optical soundtracks.
- While the film is running, look at the oscilloscope. Verify the positioning of the slit relative to the optical track. When no signal output (or a null) is seen on the scope, the lateral adjustment is correct. See diagram below. If adjustment is necessary, refer to projector manufacturer for proper alignment procedure.
 - Some projectors use a film guide that adjusts laterally for a null if the lens and exciter lamp are fixed.
 - Some projectors have a lens/exciter lamp assembly that is adjusted laterally for a null if the film is not adjustable side-to-side.
 - Some projectors use a lens that allows the width of the slit to be adjusted. The adjustment is correct when the left and right signals both disappear equally.

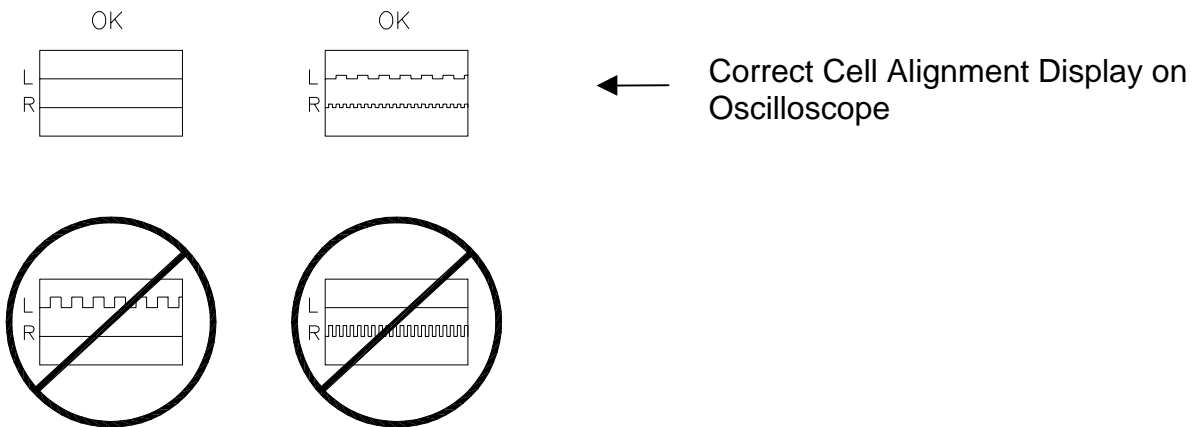

CELL ALIGNMENT ON OSCILLOSCOPE

- Continue on to **CROSS-TALK STEREO ALIGNMENT**.

6.3.2. CROSS-TALK STEREO ALIGNMENT (Projector 1)

- Run a loop of **1 kHz Cross-talk Cell Alignment** film. Verify no cross-talk between stereo tracks.
- While film is running, look at the oscilloscope (scope should be connected as shown in Section 6.1) . Cross-talk should be at a minimum, as per the diagram below. If adjustment is necessary, refer to projector manufacturer for proper alignment procedure.

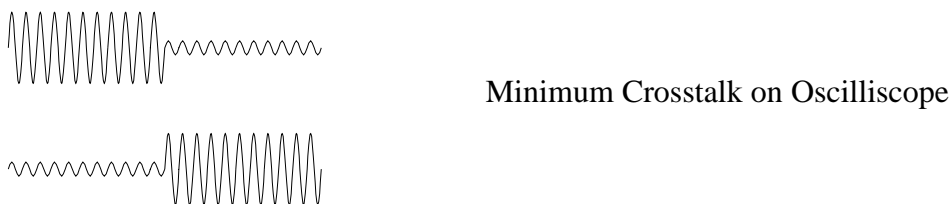

- Continue on to **SLIT LOSS COMPENSATION**.

6.4. SLIT LOSS COMPENSATION (Projector 1)

- Start by turning D744 **PROJECTOR 1 LEFT & RIGHT HF** trim-pots (20-turn) fully clockwise.
- Run a loop of **Pink Noise** film.

While in the OPTICAL SETUP screen, press F5, SET SLIT LOSS

SET SLIT LOSS screen ➤

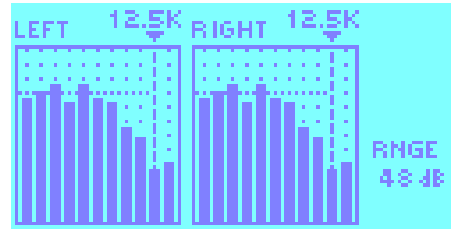

- Now, adjust **PROJECTOR 1 LEFT HF** trimpot to achieve flat response from 1 kHz to 12.5 kHz for the left cell.

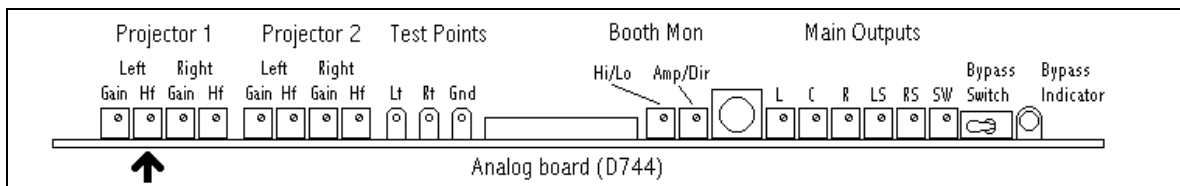

- Note that as adjustments are made, the RTA display uses a slow response curve. Make each adjustment a little at a time to ensure that over-adjustment is avoided.
- Repeat for **PROJECTOR 1 RIGHT HF**, adjust its trimpot to achieve a flat response from 1 kHz to 12.5 kHz for the right cell.

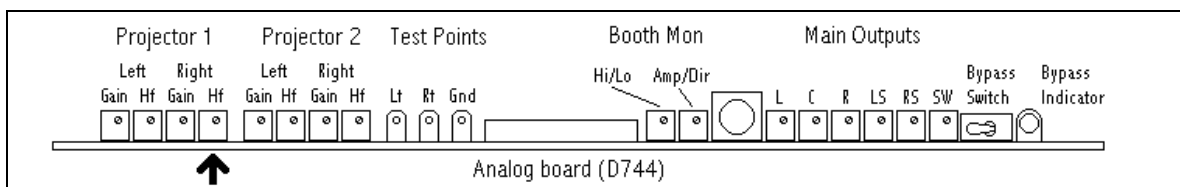

- Once adjustments are made,

Press the EXIT button to return to the OPTICAL setup screen ➤

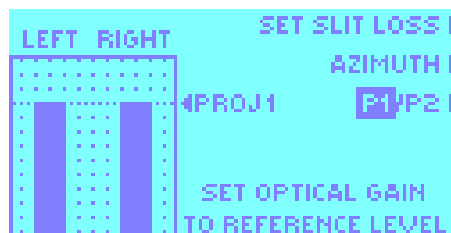

- Continue on to **AZIMUTH**.

6.5. AZIMUTH (Projector 1)

- To adjust azimuth, run a loop of **Pink Noise** film. Start from the OPTICAL setup screen:

OPTICAL setup screen ➤

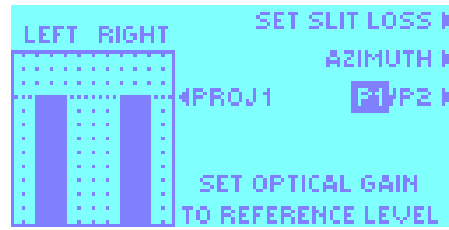

While in the OPTICAL setup screen, press F6 button to view the AZIMUTH display screen ➤

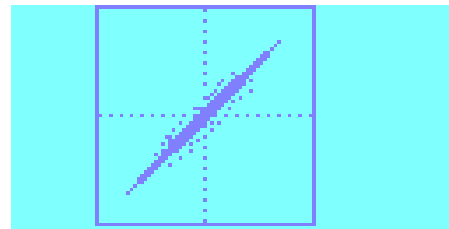

- This shows the phase difference between the left and right optical channels. The display should look like a relatively straight diagonal line from the lower left corner to the upper right corner.

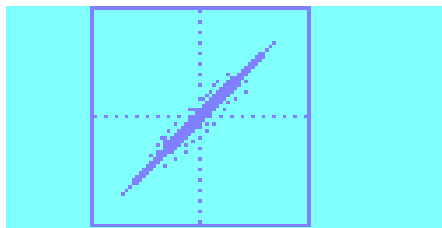

GOOD AZIMUTH

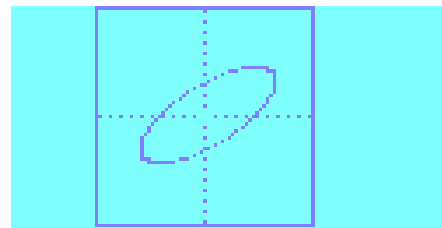

BAD AZIMUTH

- If the display is not correct, the alignment of the optical head should be checked and mechanically adjusted. Once any changes are made to the solar cell alignment, the optical gain and slit loss adjustment must be repeated.

6.6. MONO (Projector 1)

Use either the **Pink Noise** film -or- the P35-SL 1000Hz Signal, “Photographic Sound Track” (MONO), Level SMPTE Test Film. Verify the F1 key is programmed for MONO. If it is not, press MENU ➔ SYSTEM SETUP ➔ OPTIONS ➔ now, assign F1 key format to MONO. Press OK twice to save. Press FMT to return to the normal operating screen.

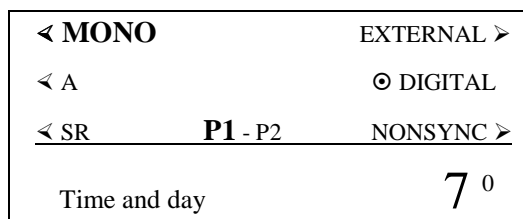

⇌ Normal Operating Screen

Run the test film and switch the sound format to F1 MONO. Pink noise should be heard in the auditorium and booth monitor coming from the center channel.

6.7. BYPASS MODE ADJUSTMENT

The DTS-6AD will automatically switch into BYPASS mode if the internal power supplies fail or if a failure occurs in the DSP (D741) or CPU (D740) boards.

If required, the user may switch the DTS-6AD the into BYPASS mode by setting the D744 “BYPASS” switch to the right.

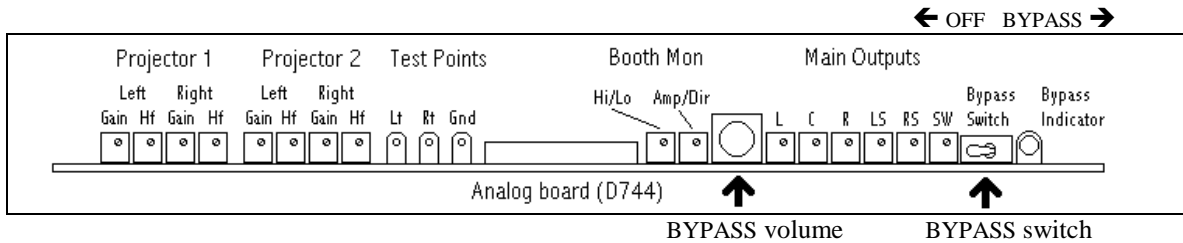

When in the BYPASS mode:

- Two red LEDs - one on the D744 board and another on the display panel - will illuminate.
- The signal from the solar cell will be routed to the screen speakers (left, center, right).
- A “BYPASS” pot on the D744 board is used to adjust volume.

BYPASS Level Adjustment

- Run **Pink Noise** (film) and set DTS-6AD to MONO format. Note SPL level in auditorium.
- Switch DTS-6AD to BYPASS mode – set “BYPASS” switch on D744 to the right.
- Adjust “BYPASS” pot on D744 to match the MONO level. Leave pot in this position.
- Switch “BYPASS” off. DTS-6AD should return to MONO.

6.8. FINAL LEVEL CHECK (Projector 1)

- Run the **50% Modulation Tone** film. Press MENU → SYSTEM SETUP → OPTICAL

OPTICAL setup screen ➤

Verify PROJ 1 LEFT & RIGHT levels are at reference (arrow)

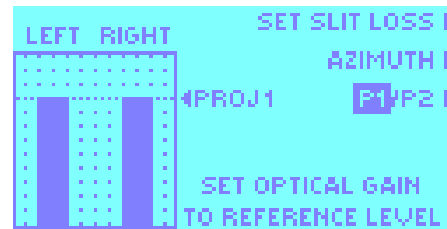

- Once completed, proceed to Projector 2, or press FMT to return to the normal operating screen.

6.9. PROJECTOR 2 ALIGNMENT

For a two projector (changeover) booth, the second projector must be aligned. The procedure for Proj.2 is basically the same as Proj.1. With film running, select Proj.2 by either: ① Making a changeover to Proj.2 (if changeover control connected to P15/16 Status/Control), or ② Pressing F7 (P1/P2) button while in the OPTICAL setup screen.

- Begin by ensuring that Projector 2’s optics have been cleaned and aligned.
- Connect oscilloscope & RTA as shown in “A-Chain Test Equipment Connections” diagram (Page 6-1).

WARNING: Entering OPTICAL Setup Screen will force the system to reset levels:
 OPTICAL GAIN = 0
 NOISE REDUCTION = OFF
 OUTPUT = MUTE

Do not select this menu while running film with an audience in the auditorium.

6.9.1. PROJECTOR 2 OPTICAL GAIN

- Run **50% Modulation Tone** film on Projector 2. Press MENU button, screen below should appear:

Main MENU ➤



Press F1 to select SYSTEM SETUP

SYSTEM SETUP menu ➤

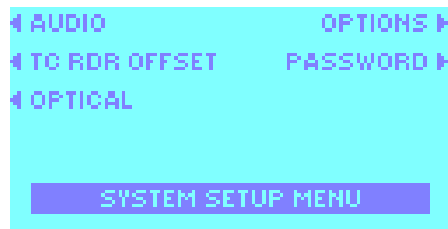

Press F3 to select OPTICAL.

OPTICAL setup screen ➤

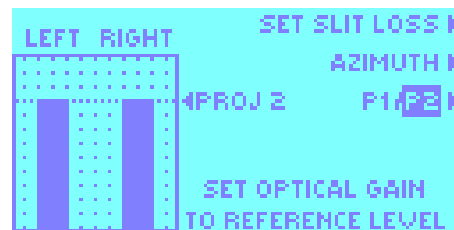

MUTE will automatically activate when OPTICAL is selected.

If P1 is displayed to the right of the level meter, press F7 button to select P2 ⬆

-continued-

6.9.1. PROJECTOR 2 OPTICAL GAIN (continued)

OPTICAL setup screen ➤

Verify PROJ 2 is displayed and P2 is highlighted. If not, press F7 button.

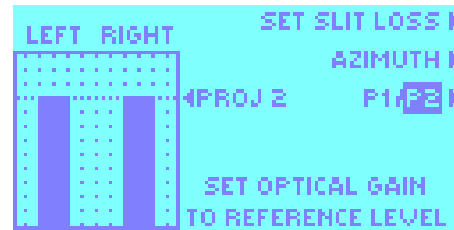

- Adjust the **PROJECTOR 2 LEFT & RIGHT GAIN** trimpots until the display shows their levels are at reference level, indicated by “◀PROJ2” on OPTICAL setup screen.

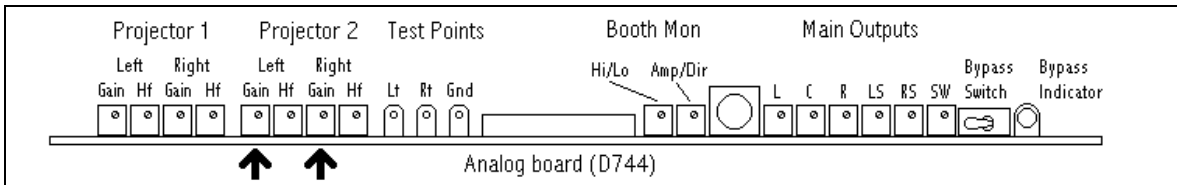

- Continue on to SLIT LOSS COMPENSATION.

6.9.2. PROJECTOR 2 CELL ALIGNMENT CHECK

- Run a loop of **SMPTE Buzz Track** film. Check for proper lateral alignment of the solar cell. The (cell) slit must be properly aligned so that the light illuminates only the optical soundtracks.
- While the film is running, look at the oscilloscope. Verify the positioning of the slit relative to the optical track. When no signal output (or a null) is seen on the scope, the lateral adjustment is correct. See diagram below. If adjustment is necessary, refer to projector manufacturer for proper alignment procedure.
 - Some projectors use a film guide that adjusts laterally for a null if the lens and exciter lamp are fixed.
 - Some projectors have a lens/exciter lamp assembly that is adjusted laterally for a null if the film is not adjustable side-to-side.
 - Some projectors use a lens that allows the width of the slit to be adjusted. The adjustment is correct when the left and right signals both disappear equally.

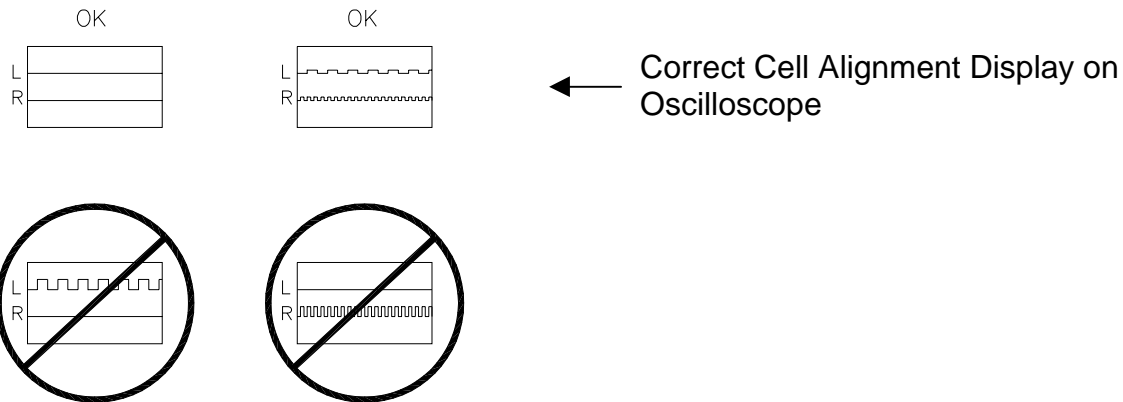

CELL ALIGNMENT ON OSCILLOSCOPE

- Continue on to CROSS-TALK STEREO ALIGNMENT.

6.9.3. PROJECTOR 2 CROSS-TALK STEREO ALIGNMENT

- Run a loop of **1 kHz Cross-talk Cell Alignment** film. Verify no cross-talk between stereo tracks.
- While film is running, look at the oscilloscope (scope should be connected as shown on Page 6.1). Cross-talk should be at a minimum, as per the diagram below. If adjustment is necessary, refer to projector manufacturer for proper alignment procedure.

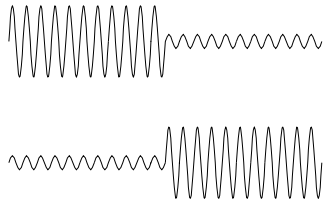

Minimum Crosstalk on Oscilloscope

- Continue on to **SLIT LOSS COMPENSATION**.

6.9.4 PROJECTOR 2 SLIT LOSS COMPENSATION

- Start by turning D744 **PROJECTOR 2 LEFT & RIGHT HF** trim-pots (20-turn) fully clockwise

From the **OPTICAL** setup screen for P2, press
F5 **SET SLIT LOSS**.

SET SLIT LOSS screen ➤

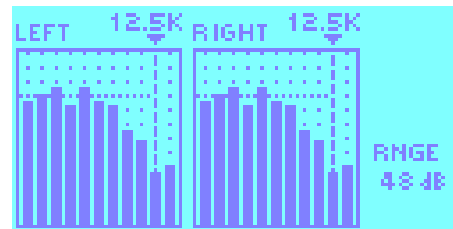

- Run a loop of the **Pink Noise** film on Projector 2.
- Adjust the **PROJECTOR 2 LEFT & RIGHT HF** trim-pots to achieve a flat response from 1 kHz to 12.5 kHz for both the left & right cells.

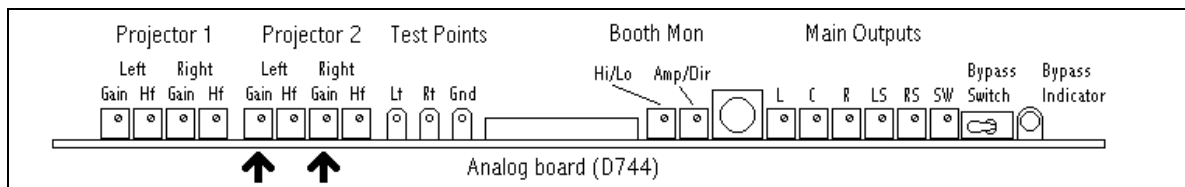

Press **EXIT** to back up to the
OPTICAL setup screen ➤

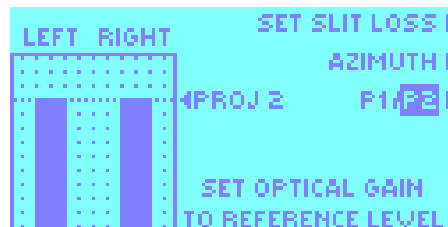

- Continue on to **AZIMUTH**.

6.9.5. PROJECTOR 2 AZIMUTH

- To adjust azimuth, run a loop of **Pink Noise** film on Projector 2.

From the OPTICAL setup screen for P2, press the F6 button to view the AZIMUTH display screen ➤

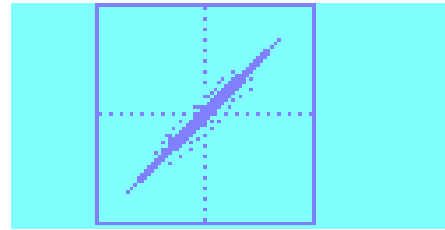

- If the display is not correct, the alignment of the optical head should be checked and mechanically adjusted. Once any changes are made to the solar cell alignment, the optical gain and slit loss adjustment must be repeated.

6.9.6. PROJECTOR 2 MONO

Use either the **Pink Noise** film -or- the P35-SL 1000Hz Signal, “Photographic Sound Track” (MONO), Level SMPTE Test Film. Verify the F1 key is programmed for MONO. If it is not, press MENU ➔ SYSTEM SETUP ➔ OPTIONS ➔ now, assign F1 key format to MONO. Press OK twice to save. Press FMT to return to the normal operating screen.

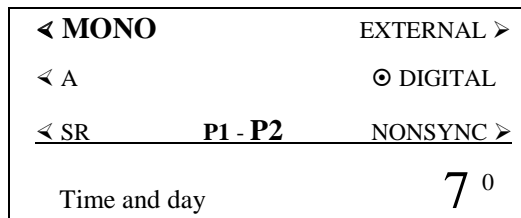

⇐ Normal Operating Screen

Run the test film on Projector 2 and switch the sound format to F1 MONO. Pink noise should be heard in the auditorium and booth monitor coming from the center channel.

6.9.7. PROJECTOR 2 FINAL LEVEL CHECK

- Run the **50% Modulation Tone** film on Projector 2. Press MENU ➔ SYSTEM SETUP ➔ OPTICAL

OPTICAL setup screen ➤

Verify PROJ 2 LEFT & RIGHT levels are at reference (arrow)

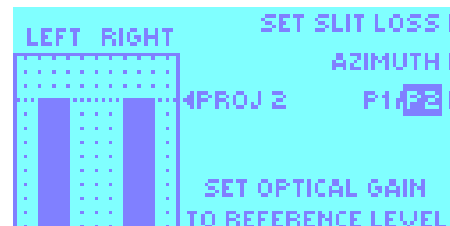

- Once completed, press FMT to return to the normal operating screen.

NOTES

Thank you for choosing DTS !

SECTION 7 DTS TIMECODE READER HEAD

7.1. DTS TIMECODE READER HEAD INSTALLATION

The DTS Timecode Reader Head is designed to mount onto most projectors with a single mounting bracket. See Page 7-2.

- Position appropriate DTS mounting bracket on the same bolt pattern as the reel arm. Bolt securely in place.
- Install the reader onto the mounting bracket and bolt into place with supplied hardware.
- Reinstall reel arm on the top bolt pattern of the mounting bracket.
- Using film, align the film path from the reel arm to the DTS reader (mounted on a bracket that is connected to the projector).
- The timecode reader **MUST** be aligned so that the film has a straight path (no angles or twists) and at least a small amount of **tension**. The auxiliary flanged roller on the timecode reader head is used to avoid film “walk out” and helps to stabilize the film by adding tension. The tension can be adjusted by changing the swing of the auxiliary roller or by adding a roller to the output of the reader (see page 7-2). Adding cleaning rollers will also help add tension, if needed.

The film should not bounce while running through the projector. If it does, this indicates a tension or platter problem.

- **Two projector (change-over) theaters**
Be sure to place each reader head at the same place on the projectors. **The delay (offset) value must be the same for the movie to play in sync at both projectors.**
- Connect the 9-pin timecode cable(s) to the reader(s) and route them to the DTS-6AD in the sound rack. Connect the reader to “PROJ 1 TC” connector on the back of the DTS-6AD. If two projectors are used, connect the second reader to “PROJ 2 TC”.

7.1.1. 70mm READER HEAD INSTALLATION

The DTS 35mm and DTS 70mm reader heads may be used at the same projector in one of two ways. ① Mount each independently of the other or ② have both use one bracket. In the first case case, each reader would be permanently mounted to the projector using two brackets - one bracket per reader. However, most will find it easier to use one bracket with breakaway plates so the readers can be switched as needed.

In either case, be sure to calculate and mark the delay (offset) for each. The delay for 35mm will be different from 70mm. See Section 7.3 for details on delay calculation.

Installation Procedure, Timecode Reader Head Auxiliary Roller

The Auxiliary Roller is designed to mount on either of the two Secondary rollers of the Timecode Reader Head, as detailed below:

1. Remove the screw ① from the end cap ② of the desired secondary roller ③, and remove the end cap ②.
2. Loosen the set screw ④ which holds the roller shaft ⑤ of the secondary roller ③.
3. Gently push the roller shaft ⑤ out of the secondary roller ③. Note: Excessive force may damage the bearings ⑥. Be careful not to lose the washer ⑦, or the bearings ⑥ that mount on the roller shaft ⑤.
4. Install the longer roller shaft ⑧ provided. Note: The flat section on the roller shaft ⑧ should face the set screw ④ in the Reader Head. About 1/4" of the longer roller shaft ⑧ will protrude from the bottom of the Reader Head.
5. Tighten the set screw ④, and replace the secondary roller ③ and end cap ②.
6. Make sure that the secondary roller ③ spins freely. If not, loosen the set screw ④ and adjust the roller shaft ⑤ up slightly. This should free the secondary roller ③. If, after adjustment the secondary roller ③ still does not spin, double check that all parts have been properly replaced onto the roller shaft ⑤.
7. Place the Auxiliary Roller ⑨ on the protruding section of the roller shaft ⑧, in the desired position ⑩, and tighten the cap screw ⑪.

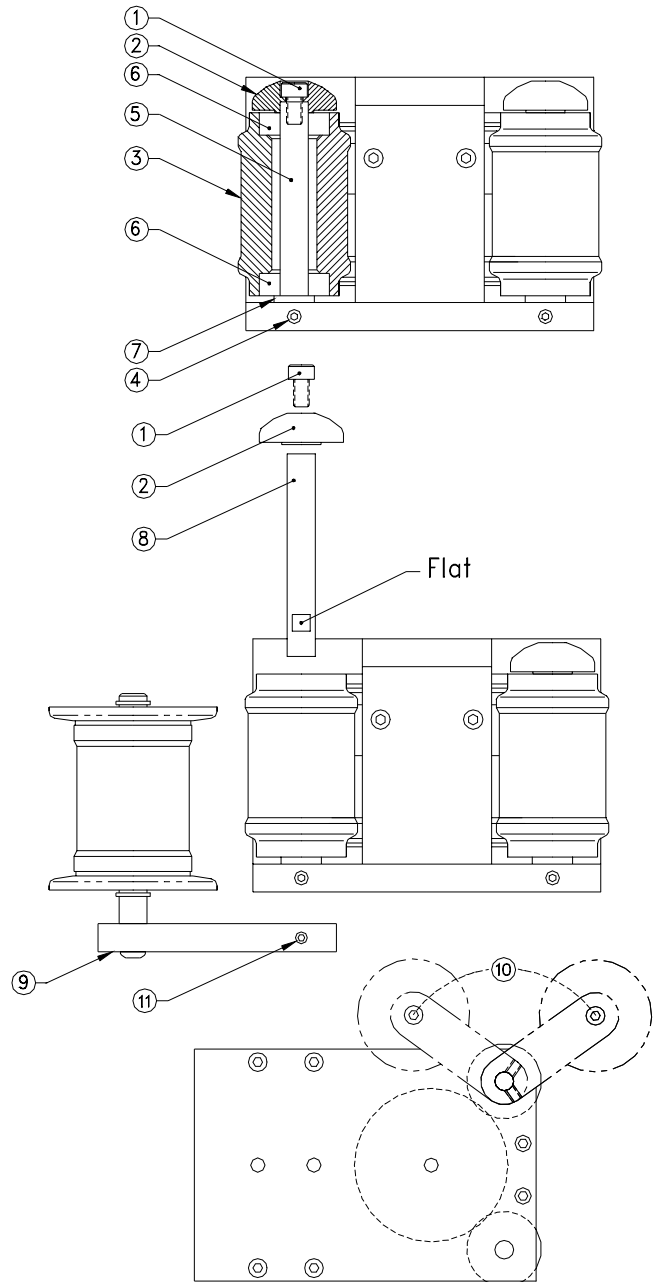



7.1.2. 70mm & 35mm READERS USED ON THE SAME BRACKET

If both 35mm and 70mm reader heads are to be used on the same bracket, add **spacer breakaway plates** to the readers. They are added to allow quick changes between the two. Keep the plates attached to the readers and maintain them as a set once the projector alignments are finished. See below.

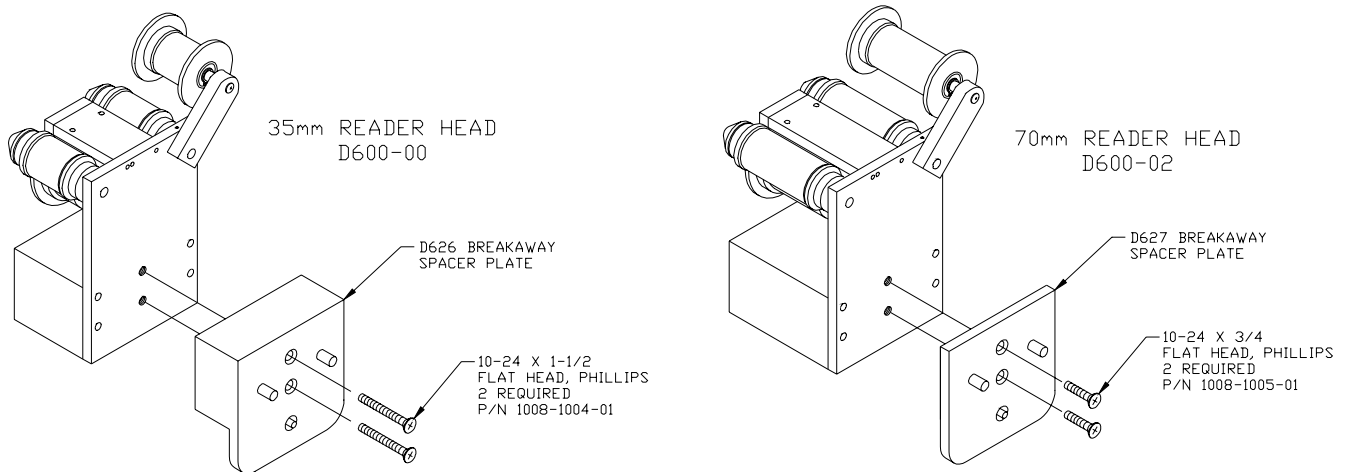
- Start by mounting the 70mm reader (with its breakaway plate attached) to the bracket. Use 70mm film to align reader. Once aligned, tighten bracket screws. Loosen the thumbscrew on the breakaway plate so that the 70mm reader detaches from the bracket.
- Now attach the 35mm reader (with its breakaway plate attached) to the bracket. Use 35mm film to verify the alignment path is correct -- no corrections should be necessary. The principle is to have one alignment for both readers so that no projector adjustments are needed when the readers are exchanged.

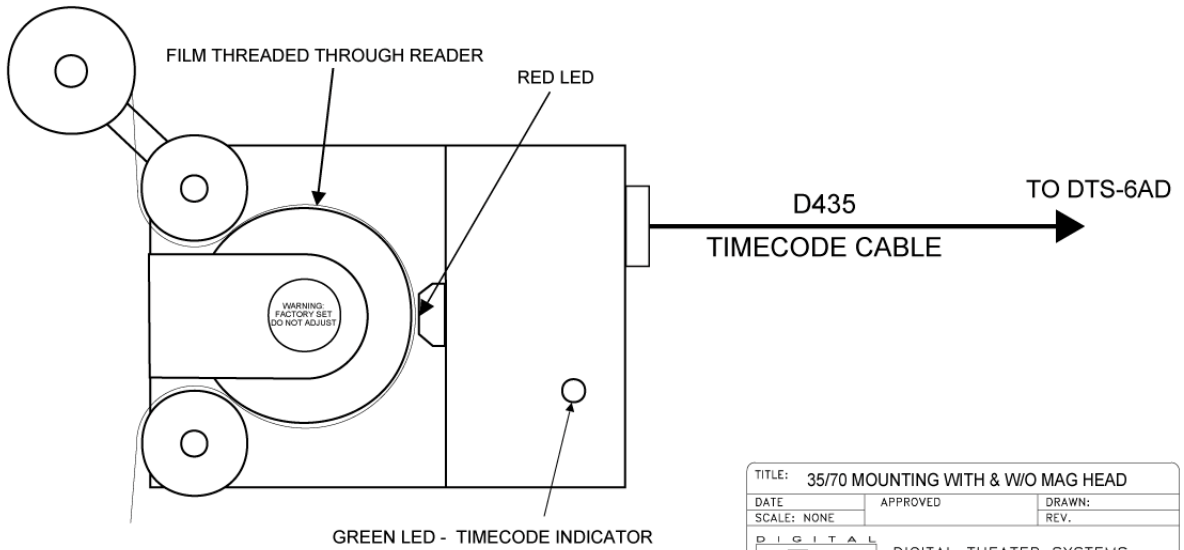
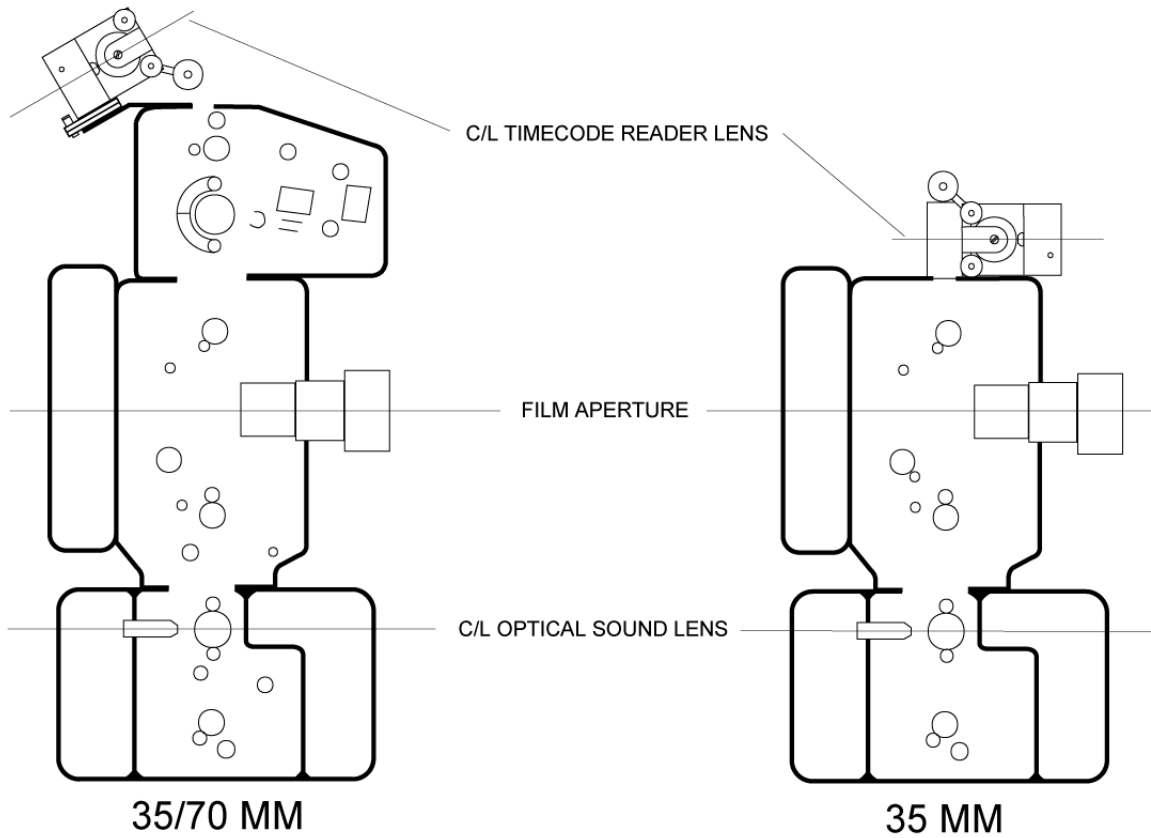



TITLE: 35/70 MOUNTING WITH & W/O MAG HEAD		
DATE	APPROVED	DRAWN:
SCALE: NONE		REV.
 DIGITAL THEATER SYSTEMS 5171 CLARETON DR. AGOURA HILLS, CA 91301		
FILE NAME	DWG.NO.	
TIE245 (3570MAG).AI	TI-E245	

DTS - 70mm Timecode Reader and Mounting Brackets

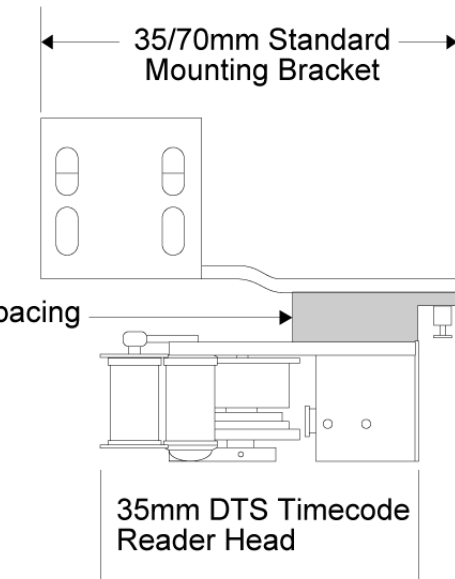
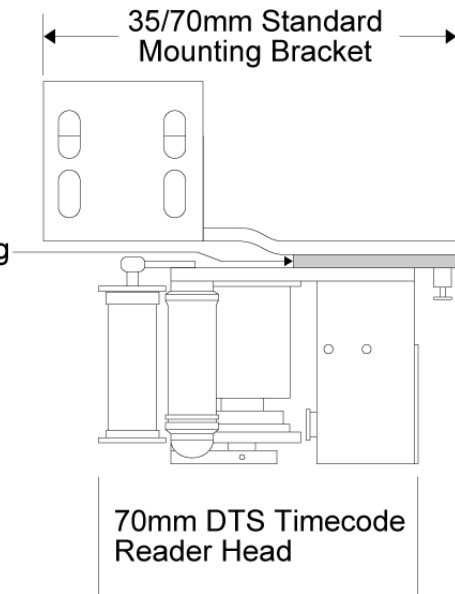
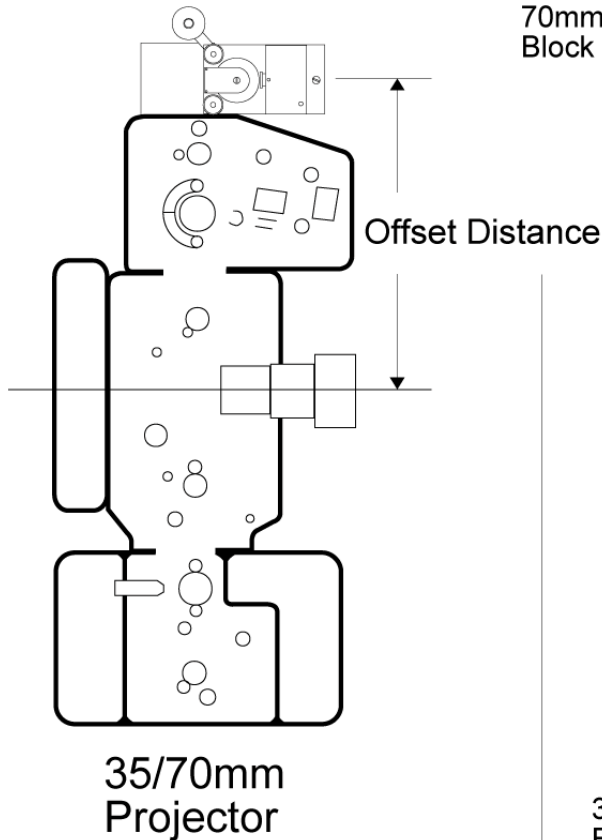

In order to properly set the offset for 70mm film on the DTS unit, count the number of frames between the picture aperture and the timecode reader head. Multiply by 1.25 and subtract one.

For example,

Distance between (70mm) Picture Aperture & Timecode Reader Head	24 Frame/Sec Offset Setting
(24 frames X 1.25) - 1	=29
(12 frames X 1.25) - 1	=14

TITLE: 70MM TCRH MOUNTING & BRACKETS		
DATE	APPROVED	DRAWN: J. DELLARIA
SCALE: NONE		REV. A
 DIGITAL THEATER SYSTEMS 5171 CLARETON DR. AGOURA HILLS, CA 91301		
FILE NAME	DWG. NO.	
TIE241A (70MM-MNT).AI	TI-E241A	

PH: 818-706-3525 Fax: 818-706-1868
 Web: www.dtsonline.com

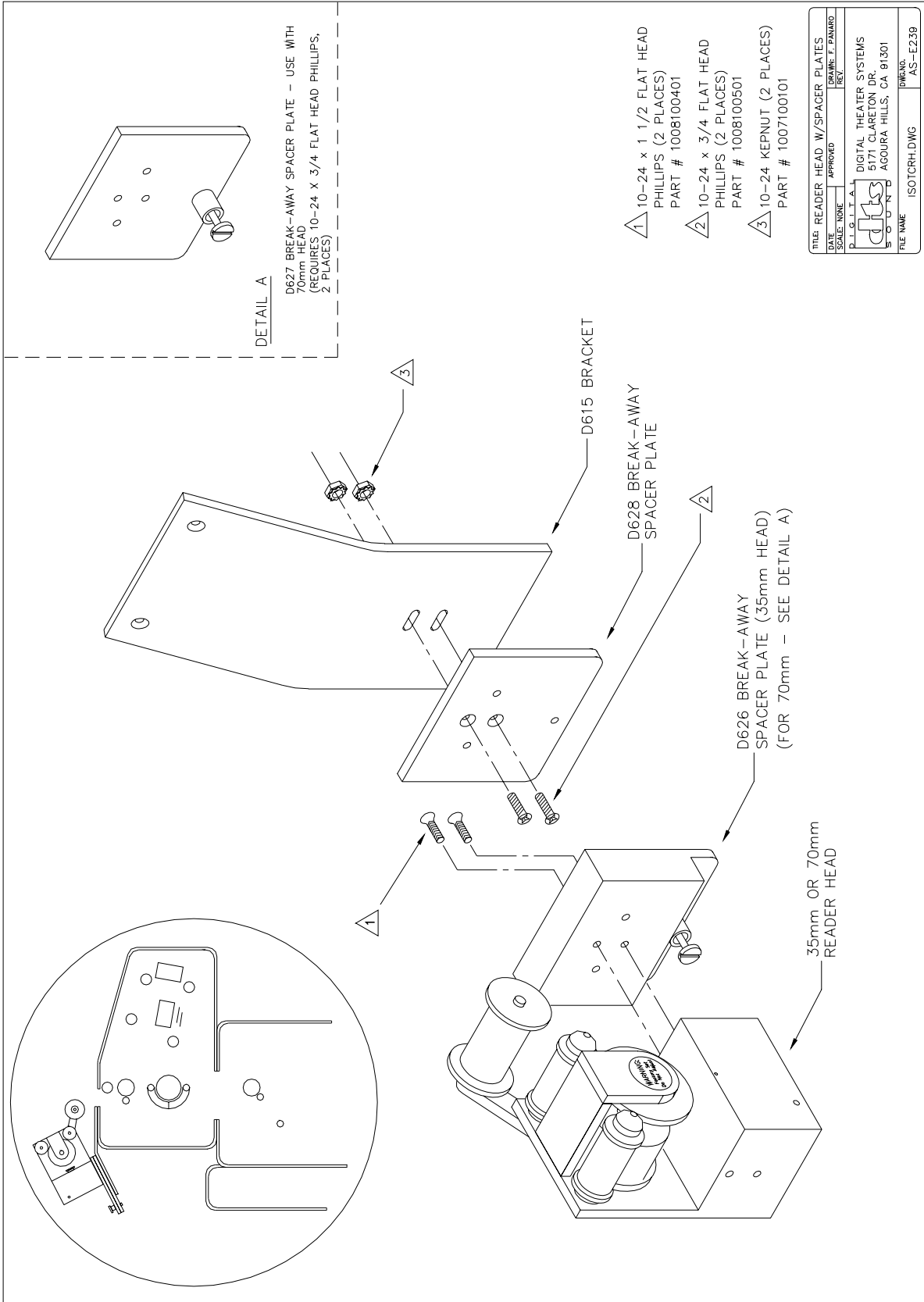

7.2. TIMECODE READER HEAD BRACKETS

- **D614 - Standard Bracket (35mm only)** -- cannot be used with breakaway plates.

- **D625 - 35mm / 70mm Standard Bracket** -- used with breakaway plates.

For projectors: Century, Simplex, and Cinemeccanica with Kelmar bracket (below). Intended to fit between the projector and reel arm. We have produced the bracket with the American standard size hole to accommodate 2" center spacing 3/8 - 16 tap, that is utilized to mount the American made upper reel arms. Comes with the following hardware:

<u>Application</u>	<u>QTY</u>	<u>Description</u>
35mm	2	10 x 24 x 1/2" long screws
35mm	2	3/4 x 16 x 1" long hex bolt nuts
35mm / 70mm	2	3/8 lock washers
70mm	2	3/8 x 1 1/2" long cap screws
70mm	2	3/8 flat washers
70mm	2	3/8 hex nuts

- **D615 - DP70 Universal Bracket (35mm only)**

Used for American projectors with a penthouse. Comes with tap and drill bit 8-32, and the following hardware:

<u>QTY</u>	<u>Description</u>
2	10 x 24 x 1/2" long screws
2	3/4 x 16 x 1" long hex bolt nuts
2	3/8 lock washers

- **D616 - AA2 bracket (35mm only)**

For Norelco AA projectors. Comes with the following hardware:

<u>QTY</u>	<u>Description</u>
2	#10 lock washers
3	5/16" x 18 x 5" long screws
3	3/8 lock washer
2	10 x 24 x 1/2" long screw

- **D617 - DP75 Bracket (35mm only)**

- **D628 - "L" adapter panel (35mm / 70mm)** -- used with D617 and breakaway plates.

Used to mount the DTS timecode reader head to the side of the projector. Comes with same hardware as the D614. D628 is used to adapt the D617 for use with the breakaway plates (D628 attaches to D617).

- **D622 - Front Mount Bracket (35mm only)**

Used when installing multiple digital sound heads or when there is not room to lift the projector arm. Used with Dolby SR-D™ and Sony SDDS™ reader heads.

- **5006-0001-00 Cinemeccanica Bracket / adapter plate (35mm only)**

For Cinemeccanica projectors. Must be used with the D164 standard bracket for mounting the DTS timecode reader head. If the reel arm needs to be remounted, two plates are required. Note: Cinemeccanica also has their own brackets available. Contact them directly.

- **D626 - Spacer Breakaway Plate** - Used to mount 35mm DTS reader to 35/70 brackets.

- **D627 - Spacer Breakaway Plate** - Used to mount 70mm DTS readers to 35/70 brackets.

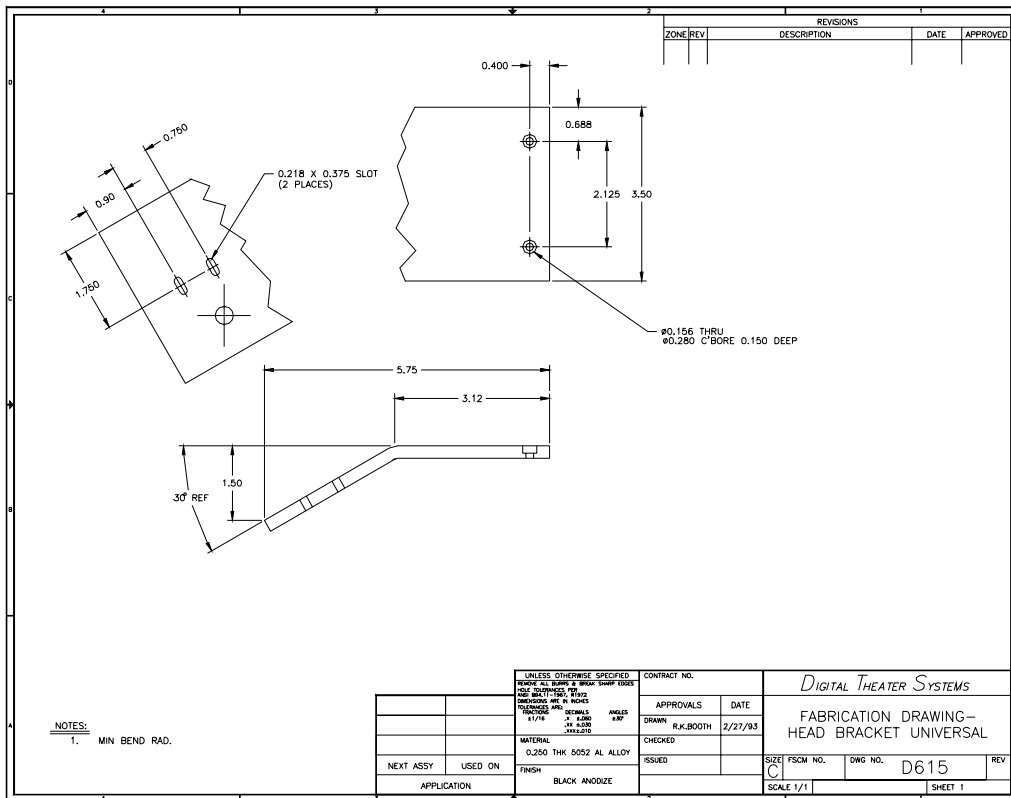
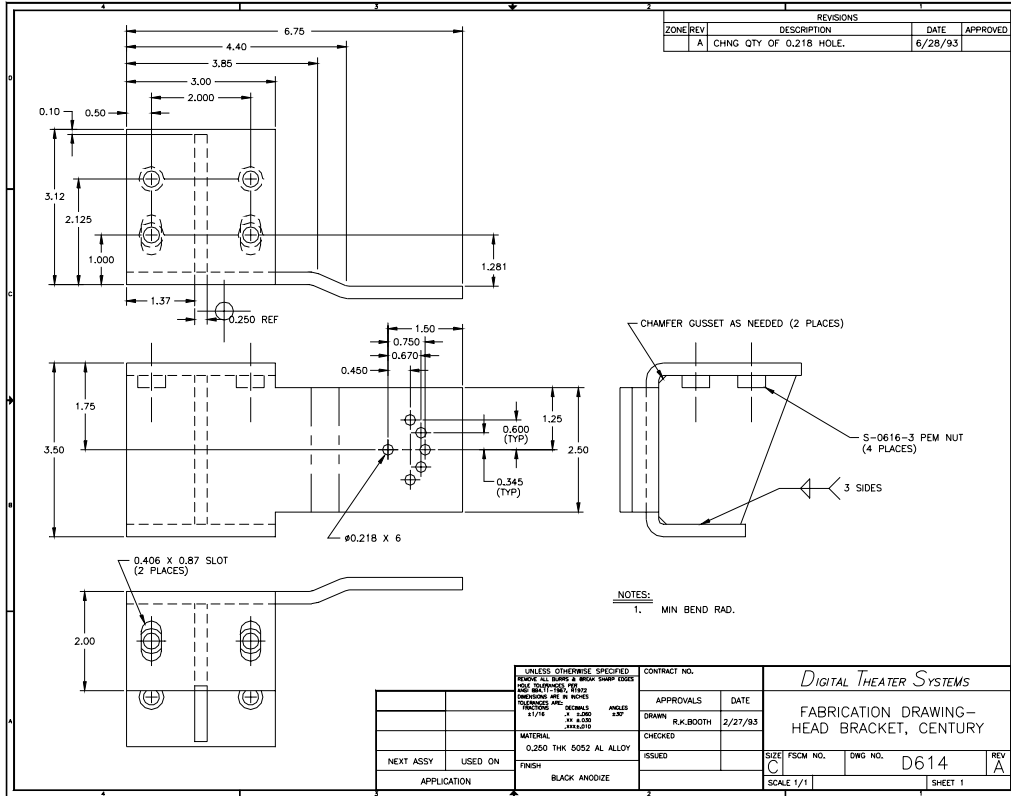

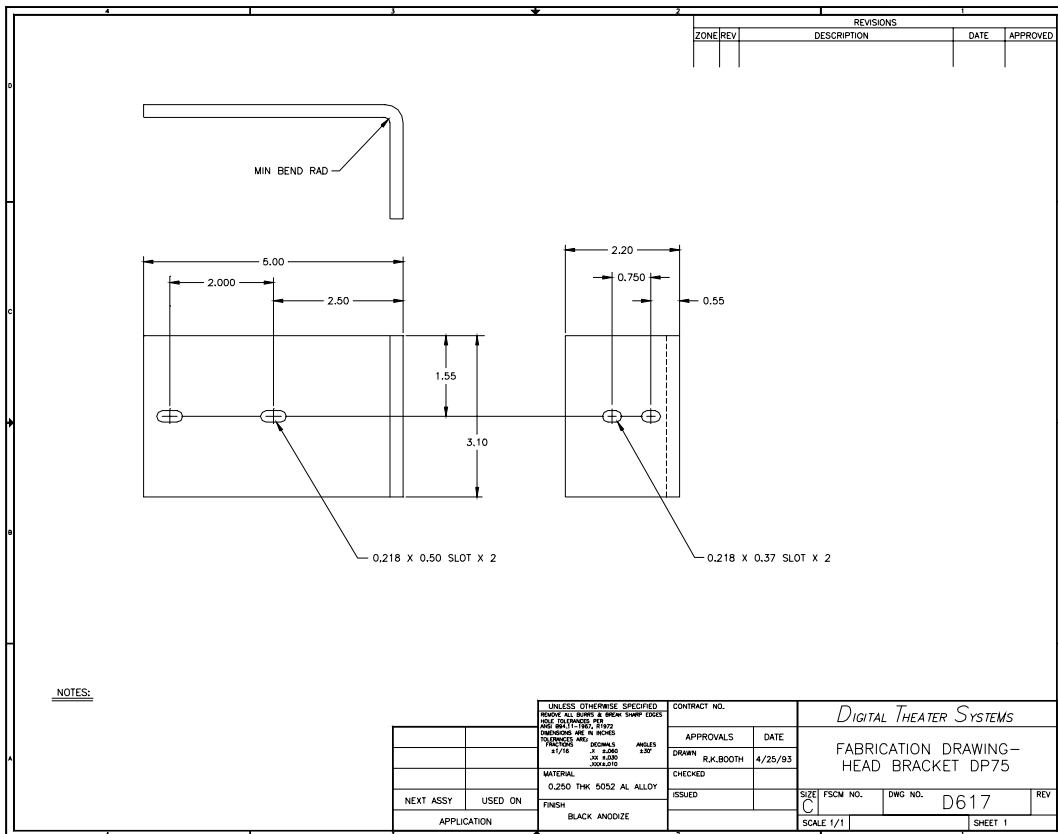
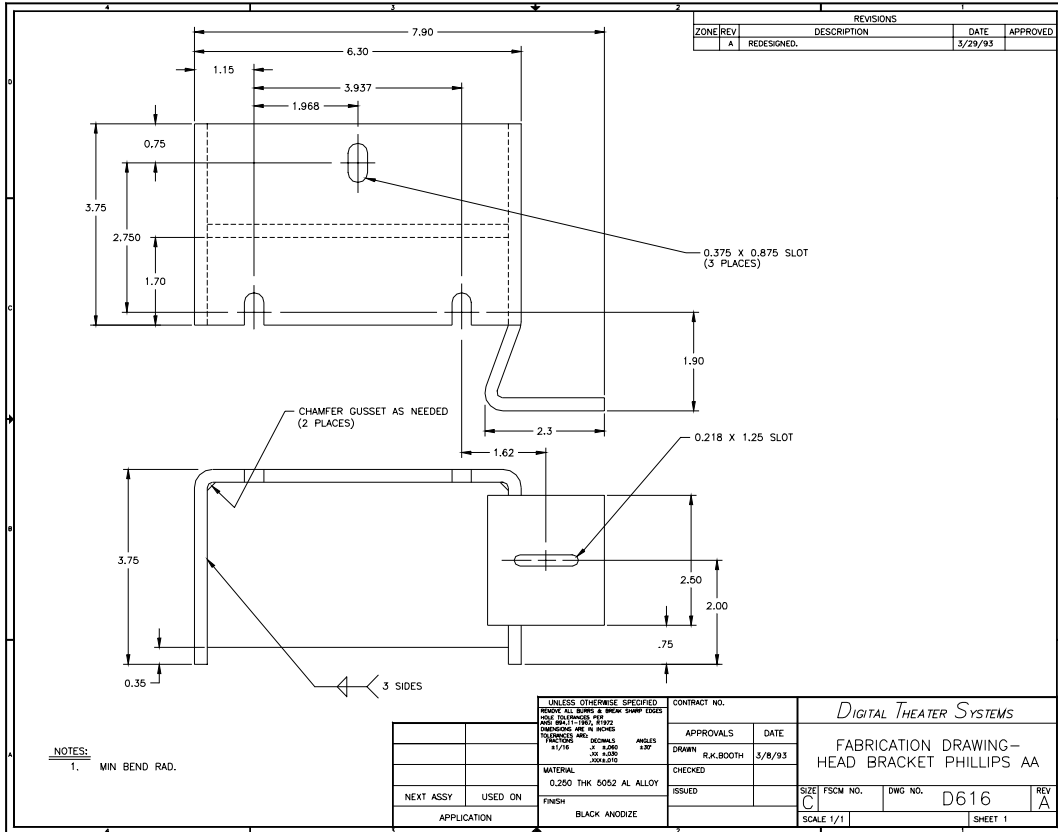

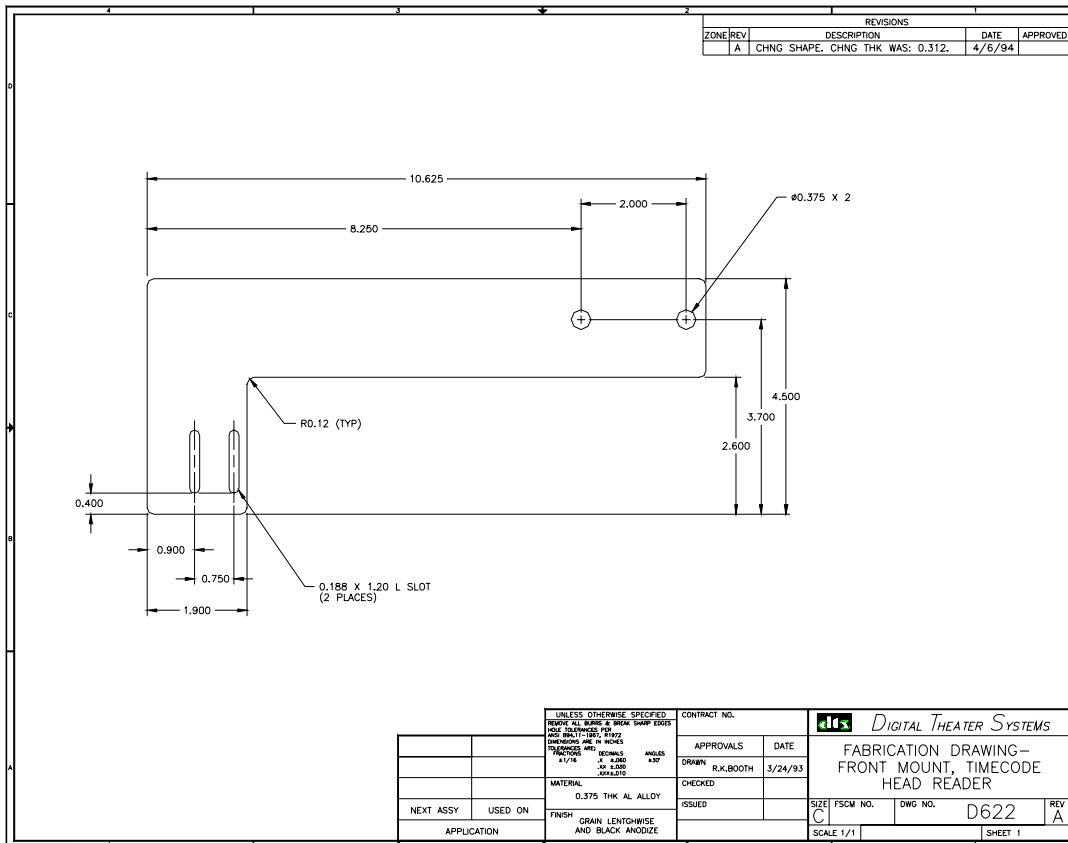
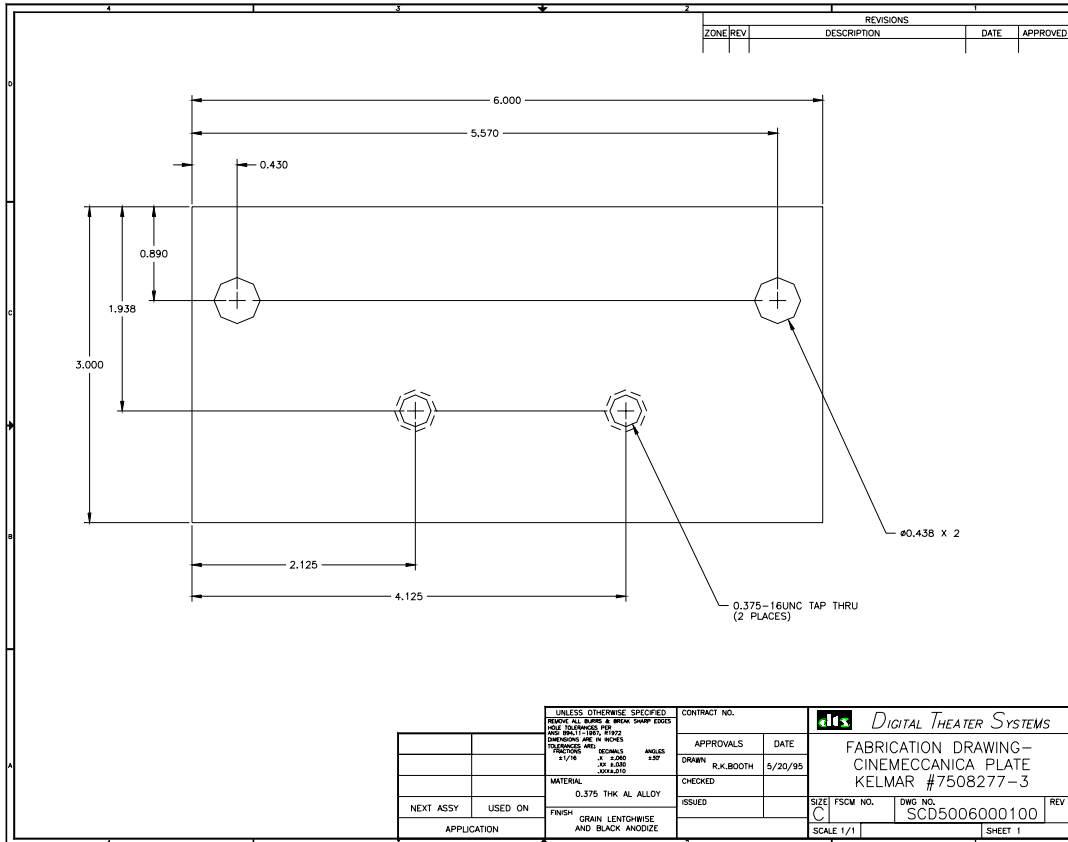

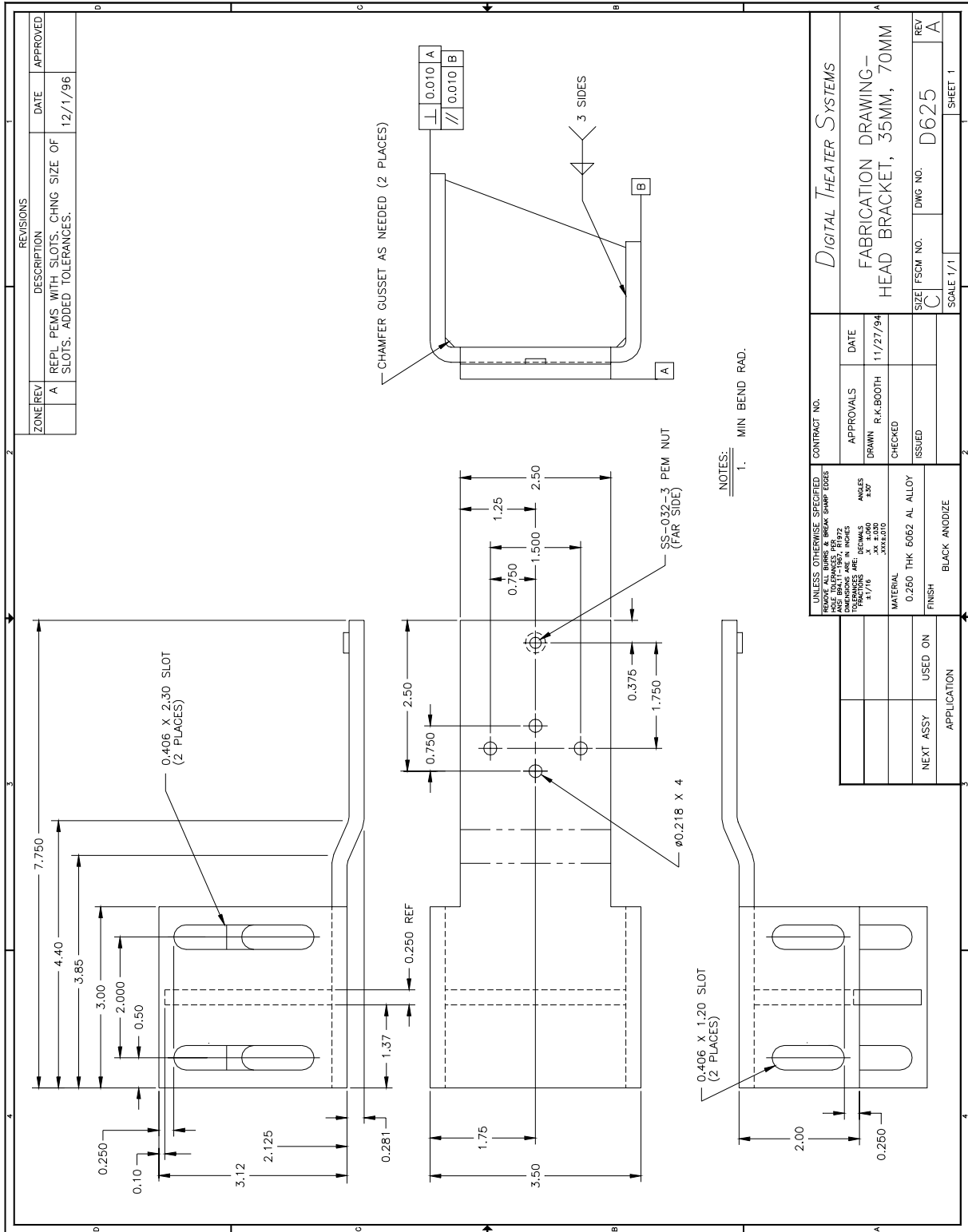

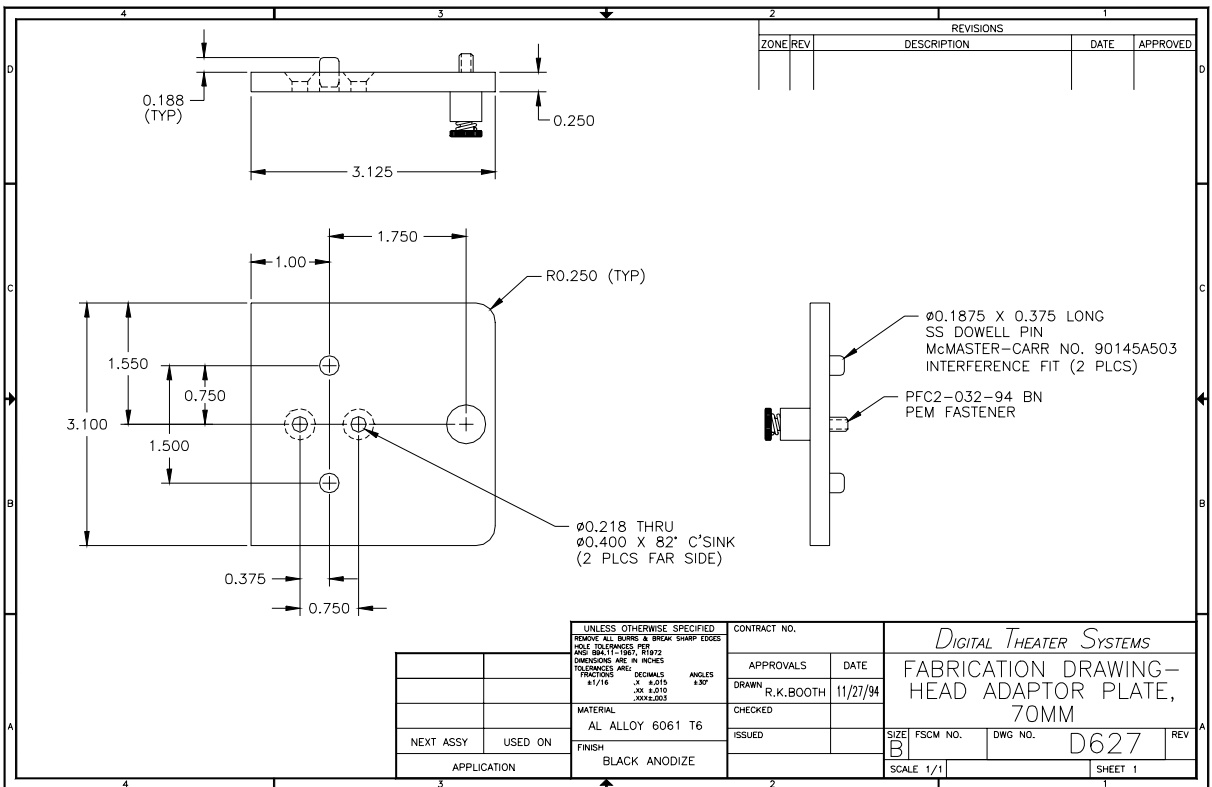
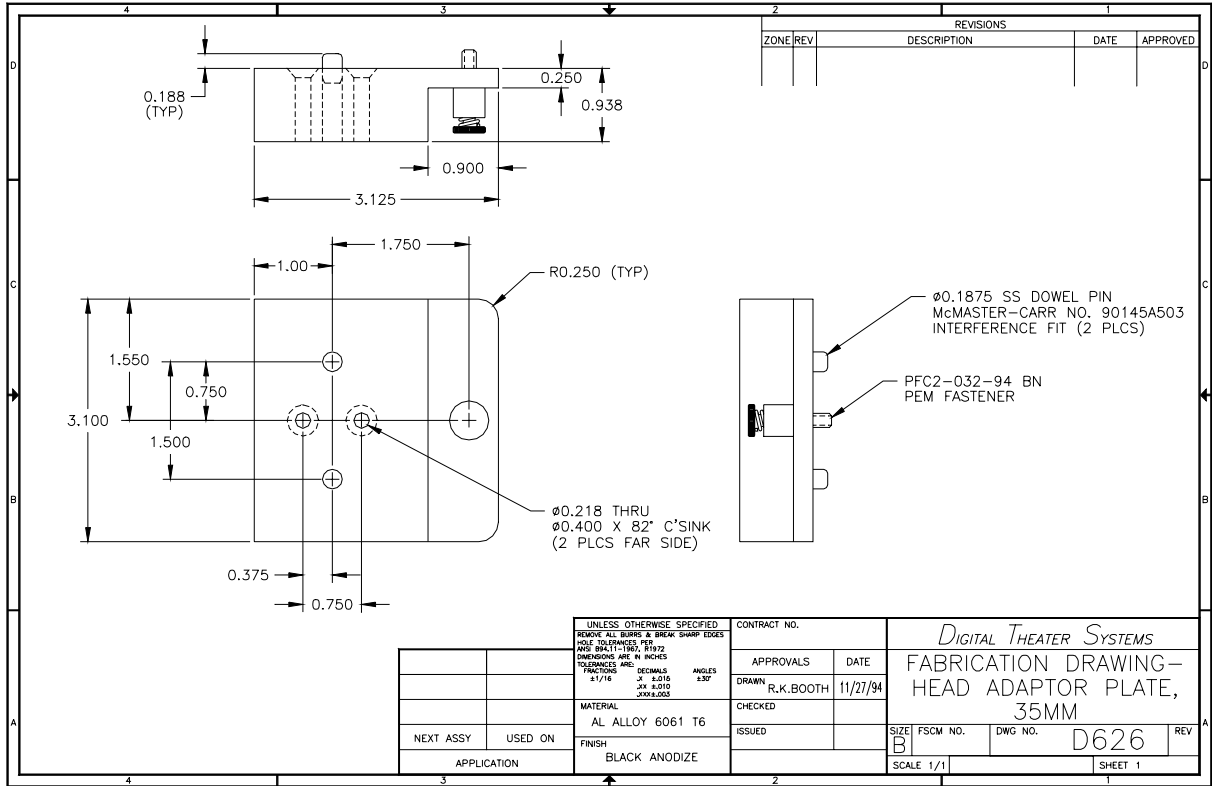

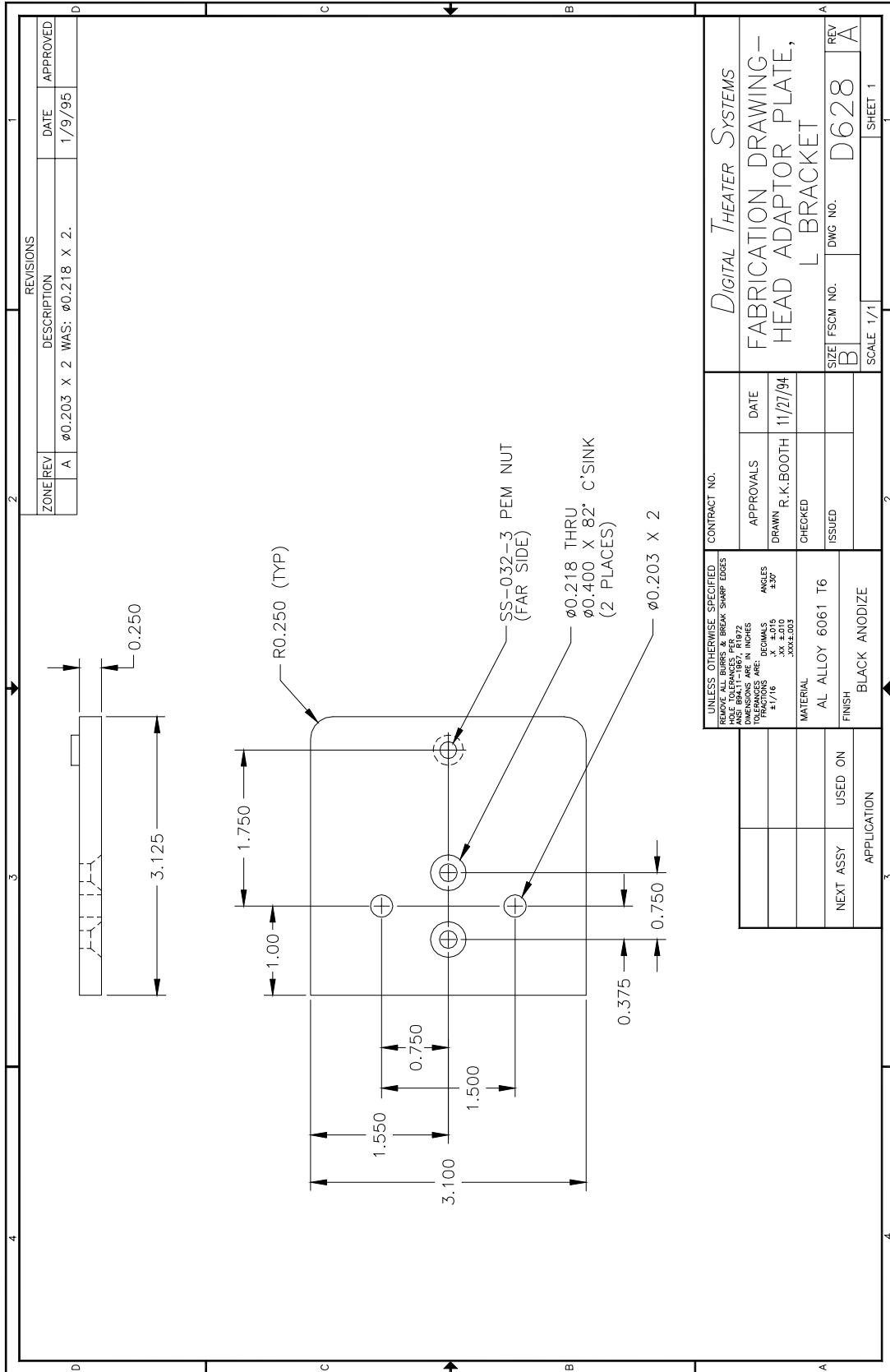

REVISIONS			
ZONE	REV	DESCRIPTION	DATE
A		$\phi 0.203 \times 2$ WAS: $\phi 0.218 \times 2$.	1/9/95
		APPROVED	

UNLESS OTHERWISE SPECIFIED ALL DIMENSIONS: BREAK SHARP EDGES ANSI Y14.5-1987, R1972 DIMENSIONS: INCHES TOLERANCES ARE: DECIMALS .XX 2.010 FRACTIONS 2/16 .XXX 0.003		CONTRACT NO.	
APPROVALS	DATE	DRAWN R.K. BOOTH 11/27/94	
CHECKED	ISSUED	MATERIAL AL ALLOY 6061 T6	
FINISH	NEXT ASSY	BLACK ANODIZE	
USED ON	APPLICATION		

Digital Theater Systems
FABRICATION DRAWING--
HEAD ADAPTOR PLATE,
L BRACKET

SIZE	FSCM NO.	DWG NO.	REV
B		D628	A

SCALE 1/1

SHEET 1	
---------	--

7.3. DETERMINING READER DELAY SETTING (sound synchronization).

- **Setting Sync for DTS 35mm**

Install the 35mm reader head(s). To set sync by *counting frames*, 35mm thread film through the projector and reader. Count the number of frames from the timecode reader head's lens (red LED inside the lens) to the projector's *picture aperture*. Multiply by 1.25 and subtract one. Set the Reader Delay Setting (via display panel menu) to this number.

EXAMPLE: 27 frames X 1.25 = 33.75 - 1 = 32.75. So, 32.75 would be the delay (offset) value.

The DTS DEMO REEL (Buzz and Bill Show film) has a specially printed offset leader used to set the reader delay. Start with "00" at the timecode reader head's lens (red LED inside lens) and thread through the projector. Read the number at the projector's optical sound head and set the DTS-6AD processor's Reader Delay Setting (via display panel menu) to this number.

The delay (offset) value must be between "15" and "99". If it is not within these parameters, relocate the reader head(s) on the projector(s) until a valid number is achieved

- **Setting Sync for DTS 70mm (5-perf)**

The DTS DEMO FILM cannot be used to set the delay or test the 70mm reader.

Install the 70mm reader head(s). To set sync by *counting frames*, thread 70mm film through the projector and reader. Count the number of frames from the timecode reader head's lens (red LED inside the lens) to the projector's *picture aperture*. Multiply by 1.25 and subtract one. Set the Reader Delay Setting (via display panel menu) to this number.

EXAMPLE: 27 frames X 1.25 = 33.75 - 1 = 32.75. So, 32.75 would be the delay (offset) value.

There is a special DTS 70mm offset leader available, P/N 6800-000-02. This leader is used to measure reader delay for 70mm film only. Start with "00" at the Timecode Reader Head's lens (red LED inside the lens) and thread the leader through the projector. Read the number at the projector's picture aperture. This is the delay (offset) value. Set the DTS-6AD processor's Reader Delay Setting (via display panel menu) to this number.

The offset number must be between "15" and "99". If the offset is not within these parameters, relocate the reader head(s) on the projector(s) until a valid number is achieved

IMPORTANT: Make the same size film loops inside the projector when measuring the offset as when running a movie. Failure to do so will result in improper sync when the movie runs in DTS digital sound.

- **Using both the DTS 35mm and DTS 70mm readers with one DTS-6AD.**

Do the steps above. The offset setting for the 35mm and the 70mm reader will not be the same. *Remember to change the delay (offset) setting (on the DTS-6D) when changing reader heads.*

For quick reference, use indelible ink and write down the 70mm and 35mm offset settings on masking tape. Attach the masking tape to the reader head bracket.

7.4. PROGRAMMING READER DELAY (OFFSET) SETTING

Start by pressing MENU button.

Main Menu ➤

Press F1, SYSTEM SETUP, to enter System Setup Menu



System Setup Menu ➤

Press F2, TC RDR OFFSET, to enter Reader Delay Setting Screen

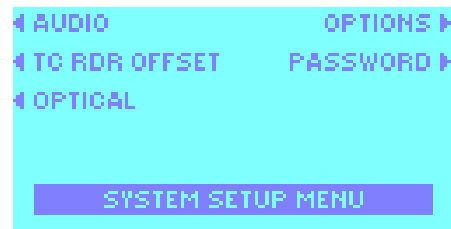

Reader Delay Setting Screen ➤

TC FRAMES should match measured delay (offset) value

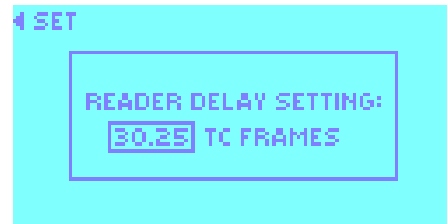

If the TC FRAMES value is not correct, press F3 & F4 keys \uparrow \downarrow to make necessary corrections. Or, hold down F1 SET button and turn the master fader to make adjustment

7.5. TESTING THE DELAY SETTING

- Thread the Buzz and Bill Film and load the Buzz and Bill Show Discs into the DTS-6AD.
- Play the film. Verify the film plays in DTS Digital: F6 DIGITAL key should highlight. Turn up monitor speaker to a pleasant listening volume.
- While film plays, press and hold down the monitor “AMPS” and “C” buttons on the display panel. When they are pressed, all the other buttons will dim but sound will be heard in monitor speaker.

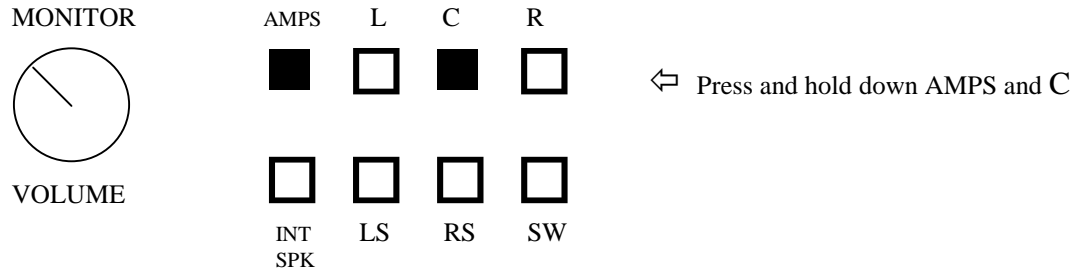

- Pressing these two buttons routes the analog output signal and digital center channel output to the monitor speaker. These two outputs should now be heard equally in the monitor speaker. If echo is heard, it means the delay setting is not correct.
- Re-set the delay until no echo is heard. Do this by entering the Reader Delay Screen. To enter, press MENU → SYSTEM SETUP → TC RDR OFFSET.

Reader Delay Setting Screen ➤

Change TC FRAMES by pressing F3 ↑ ↓ F4 keys until no echo is heard in the monitor speaker.



- Once delay is set, press OK twice to save. Press FMT to return to normal operating screen.

DTS 35mm TRACK SPECIFICATION

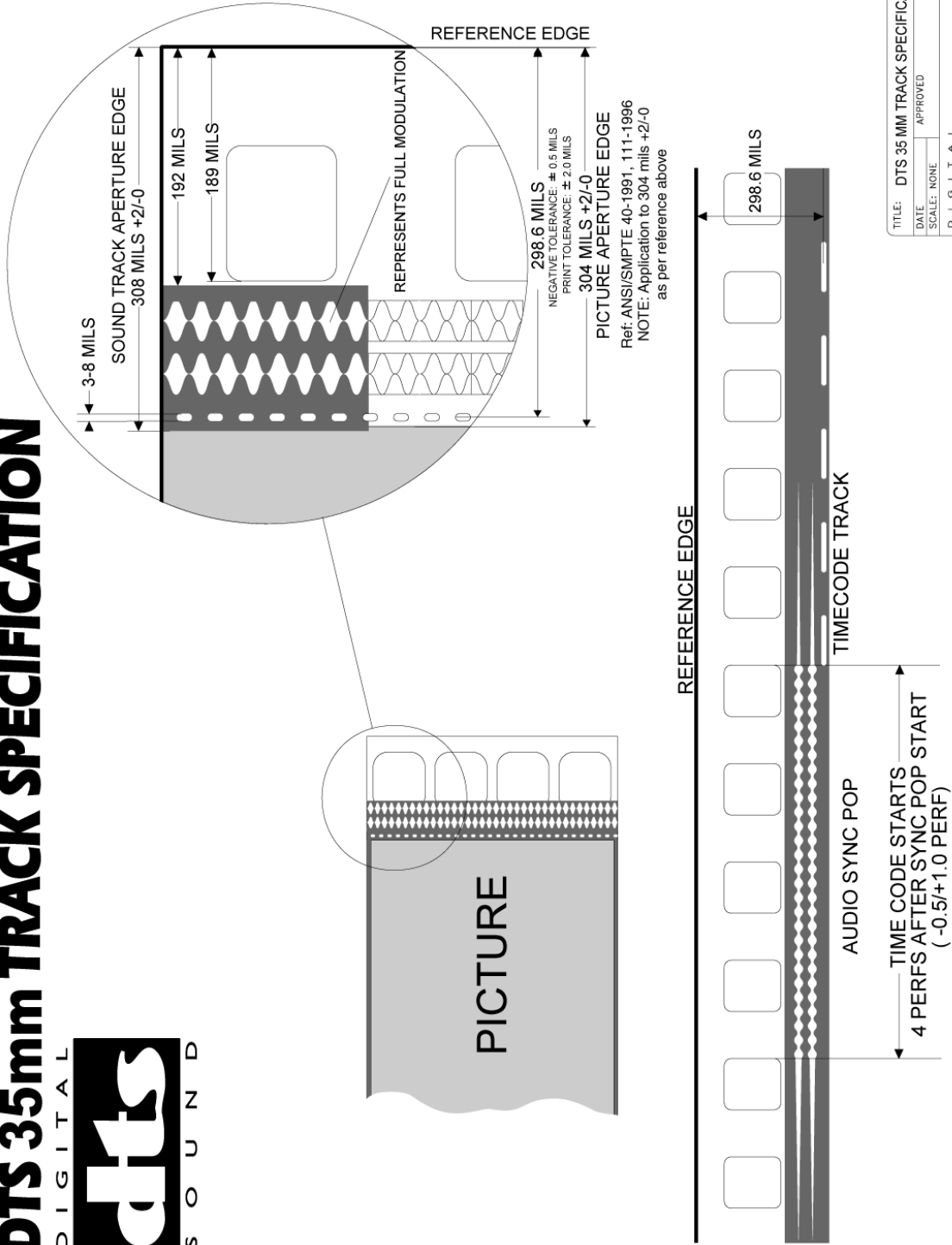
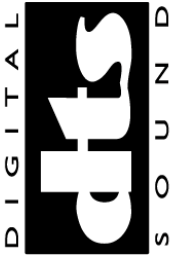

TITLE: DTS 35 MM TRACK SPECIFICATION	
DATE:	APPROVED: DRAWN: J. DELLARIA
SCALE: NONE	REV: A
DIGITAL THEATER SYSTEMS 5171 CLARETON DR. AGOURA HILLS, CA 91301	
FILE NAME: TIE243A (FILMSPEC)AI	DWG. NO.: TIE243A

PH: 818-706-3525 Fax: 818-706-1868
 Revised: February 16, 2000

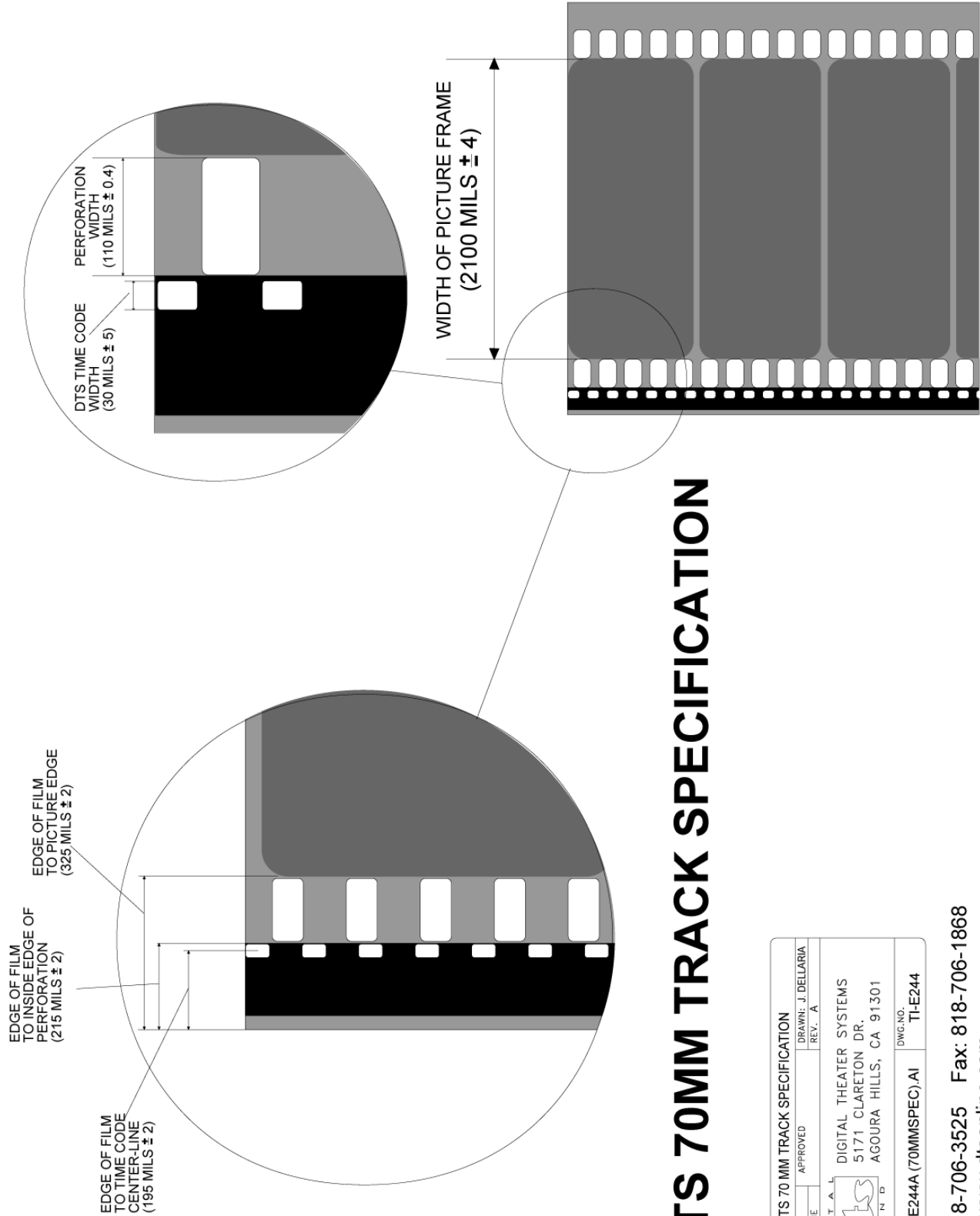

DTS 70MM TRACK SPECIFICATION

TITLE: DTS 70 MM TRACK SPECIFICATION		DRAWN: J. DELLARIA	
DATE:	APPROVED:	REV. A	
SCALE: NONE	DIGITAL		
			
DIGITAL THEATER SYSTEMS			
5171 CLARETON DR.			
AGOURA HILLS, CA 91301			
SOUND		DWG. NO.	
FILE NAME: TIE244A (70MMSPEC).AI		TH-E244	

PH: 818-706-3525 Fax: 818-706-1868
 Web: www.dtsonline.com

SECTION 8 MENUS AND FINAL PROGRAMMING

8.1. MENUS

All DTS-6AD programming menus are accessed by pressing the front panel MENU button.

MAIN MENU

- ★ **SYSTEM SETUP** Contains menus to setup the DTS-6AD system
 - SET CLOCK Screen to set Time, Day, & Date displayed on main operating screen
 - STATUS Gives playback status of movie disc playing with DTS encoded film
 - VERSION. Displays software version of CPU, DSP controller, & DSP firmware

- ★ **SYSTEM SETUP MENU**
 - ◇ **AUDIO** Audio Setup Menu
 - TC RDR OFFSET Screen to set timecode reader offset delay
 - ◇ **OPTICAL** Optical Setup Menu
 - ◇ **OPTIONS** Options Menu
 - PASSWORD Screen to set password

 - ◇ AUDIO SETUP MENU
 - **ROOM EQ** Room EQ Setup Menu
 - LEVEL Screen to check and set level to reference
 - PHASE Screen to test speaker phase
 - RT-60 Screen to perform reverb time delay test
 - AUTOMATION TRIM Screen to set auto trim value for MONO, SR, A, (DTS) DIGITAL, EXTERNAL
 - NONSYNC TRIM Screen to set NONSYNC auto trim value
 - SURROUND DELAY Screen to set surround delay value
 - **LOAD/STORE** Load/Store Setup Menu

 - ROOM EQ SETUP MENU
 - LEFT Screen to set EQ for Left channel
 - CENTER Screen to set EQ for Center channel
 - RIGHT Screen to set EQ for Right channel
 - LEFT SURROUND Screen to set EQ for Left Surround channel
 - RIGHT SURROUND Screen to set EQ for Right Surround channel
 - COPY EQ SETTINGS Screen to copy EQ settings from one channel to another
 - CLEAR EQ SETTINGS Screen to clear EQ settings from memory

 - LOAD/STORE SETUP MENU
 - STORE SETUP 1 Screen to store EQ setups in file #1
 - STORE SETUP 2 Screen to store EQ setups in file #2
 - LOAD SETUP 1 Screen to load EQ setups in file #1
 - LOAD SETUP 2 Screen to store EQ setups in file #2
 - INFO Displays time/date of current EQ setup, and stored files Setup 1 & Setup 2

 - ◇ OPTICAL SETUP MENU
 - SET LEVEL Screen to set optical level to reference
 - SET SLIT LOSS Screen to view cell slit loss
 - AZIMUTH Screen to view azimuth
 - P1/P2 Selects display for projector 1 or projector 2

 - ◇ OPTIONS MENU
 - ASSIGN F1 KEY FORMAT Screen to program sound format to F1 key (factory set = MONO)
 - DISABLE MATRIX Screen to disable internal matrix decoder
 - NONSYNC OUTPUT MODE Screen to program NONSYNC output to screen, surrounds, or matrix (aka LrRt)
 - SET DEFAULT FORMAT Screen to program default sound format (factory set = NONSYNC)
 - REMOTE FADER ENABLE Screen to enable use of remote fader

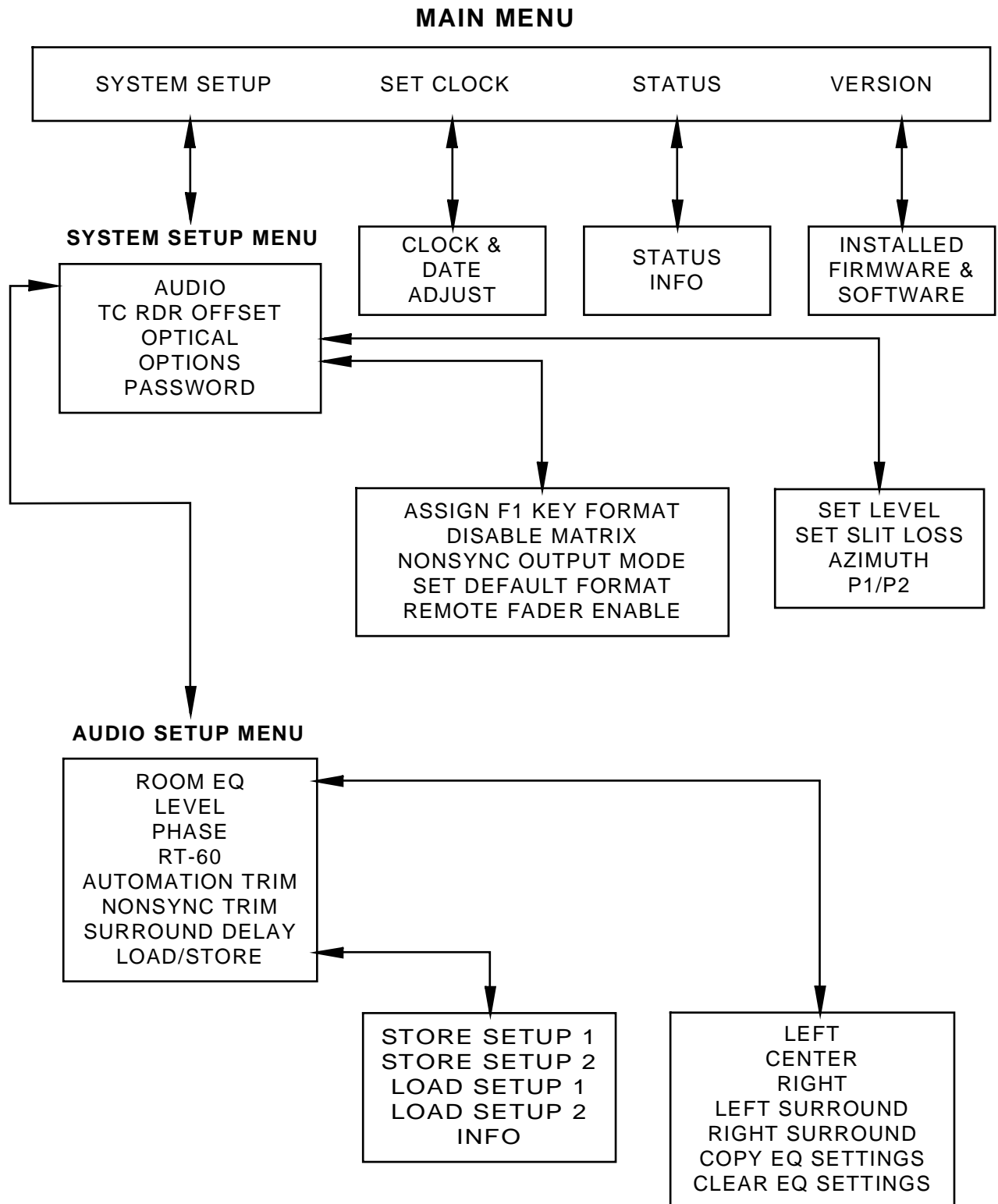

8.2. INFORMATION MENUS (nothing is programmable in these menus)

8.2.1. STATUS

The Status Screen allows the user to monitor the current state of the DTS-6AD. To enter the Status Screen, press MENU → STATUS. Press F3 & F4 ↑ ↓ to scroll through status items.

- With **no discs playing**, the screen below should display:

	SERIAL #	=	UNKNOWN
	EDITS	=	0
	DMA QUEUE	=	0
	END OF FILE	=	FALSE
	SYNC ERROR	=	-- MS
	CURRENT FMT	=	<u>NONSYNC</u>
Press	SOUND START	=	-----
F4 ↓	FAIL	=	QUEUE EMPTY
	FILES READY	=	TRUE

- When **discs are playing**, the screen below should display:

	SERIAL #	=	GOOD
	EDITS	=	1
	DMA QUEUE	=	114
	END OF FILE	=	FALSE
	SYNC ERROR	=	0 MS
	CURRENT FMT	=	<u>DIGITAL</u>
Press	SOUND START	=	81
F4 ↓	FAIL	=	SYSTEM OK
	FILES READY	=	TRUE

Description of each display item

SERIAL #	State of serial number. GOOD = on disc, UNKNOWN = not receiving TC (timecode), BAD = serial # not on disc.
EDITS	Counts film splices and jumps in TC. Number over 30 could indicate variable projector speed or faulty printing of TC on film.
DMA QUEUE	Dependant on delay (offset) setting. Shows number of audio blocks in buffer memory. OK for number to change while disc plays, typically around 114. Should not be 0.
END OF FILE	FALSE = normal operation when playing disc TRUE = TC read past end of file (could see if using TC Generator)
SYNC ERROR	Indicates projector speed problem. 60+ ms will cause sound edit to occur.
CURRENT FMT	Displays current audio format, also seen on normal operating screen.
SOUND START	If starting from film beginning, shows frames from pop to digital sound start, normally 55 to 60. If starting within a reel, shows TC# (on film) of digital sound start.
FAIL	<u>Displays type of (DTS digital) failure</u> SYSTEM OK = normal operation when playing in DTS digital END OF FILE = sound file on disc ended SERIAL# = serial number on film does not match or cannot find serial number on disc QUEUE EMPTY = TC ended DEV STAT CHG = disc ejected or drive stopped spinning DISC NOT RDY = disc loading, not ready to play
FILES READY	TRUE = disc/software files loaded, FALSE = disc/software files loading.

8.2.2. VERSION

This screen displays the software and firmware versions installed in DTS-6AD. To view the Version Screen, press MENU → VERSION. The information below should appear:

CPU VERSION	V_.__	Displays software version on D740 board.
DSP CONTROLLER	V_.__	Displays firmware on installed at IC1 on D741 board.
DSP FIRMWARE	V_.__	Displays DSP software version on the D741 board.

Contact DTS for current software/firmware versions.

8.3. FINAL PROGRAMMING MENUS

8.3.1. PASSWORD

Allows the user to program a password, which in the DTS-6AD, is a sequence of format keys. Once password protected, users must re-enter the password to access programming menus. To enter the password programming screen, press MENU → SYSTEM SETUP → PASSWORD. The screen below should appear:

◀ SET			
ASSIGN MENU PASSWORDS			
<u>MENUS</u>	<u>ENABLE</u>	<u>KEY SEQUENCE</u>	If SHOW appears in menu, ignore it.
SYSTEM	NO	F1 – F1 – F1 – F1	It is not used.

System Password is set by holding down F1 (SET) and turning master fader. Item encircled will change. Or, the selection can be made by pressing F3 & F4 ↑ ↓ to scroll through selections and F7 & F7 ← → to scroll through items to program.

Procedure: From the screen above, press F7 until the box below “enable” is encircled (where “NO” is shown above). Once encircled, press F3 to change box to “YES”. Now, program the “key sequence” by pressing F7 so that the first box is encircled. Press F3 to changed box to key desired (keys F1 to F8 can be chosen). Once selected, press F7 to go to the next box and press F3 to choose key. Repeat for all 4 boxes. Once set, press OK to save. Screen will display “Save Current Settings? OK or Exit”. If setting correct, press OK. If not correct, press EXIT and make corrections. To return to the normal operating screen, press FMT.

Be sure to use a password that is easily remembered.

Now, when the MENU button is pressed, the screen will display:

PLEASE ENTER THE PASSWORD TO ACCESS THE SYSTEM SETUP MENU
□-□-□-□

Enter Key Sequence programmed (from above procedure). If password forgotten, contact DTS.

8.3.2. ASSIGN F1 KEY FORMAT

This is used to assign a sound format to the DTS-6AD front panel F1 key. The **factory setting** for F1 is MONO. To change the format, press MENU → SYSTEM SETUP → OPTIONS. The screen below should appear:

◀ SCROLL	NEXT ▶
	BACK
<u>ASSIGN F1 KEY FORMAT</u>	
<input checked="" type="checkbox"/> MONO	
<input type="checkbox"/> EXTERNAL NOISE REDUCTION	
<input type="checkbox"/> INTERNAL A	<input type="checkbox"/> INTERNAL SR

The MONO box should be highlighted. To select another format, press F3 & F4 ↑ ↓. Once selection completed, press OK twice to save setting. To return to the normal operating screen, press FMT button.

8.3.3. NONSYNC OUTPUT MODE

This is used to assign NONSYNC audio output to certain channels or through the entire auditorium in matrix (i.e. Lt/Rt: Left, Center, Right, Surrounds). **If curtains remain closed during intermission, its best to set NONSYNC output to the surrounds only.**

Factory setting for the NONSYNC OUTPUT MODE is “SCREEN”. To change this selection, press MENU → SYSTEM SETUP → OPTIONS → NEXT → NEXT. The screen below should appear:

◀ SCROLL	NEXT ▶
	BACK ▶
<u>NONSYNC OUTPUT MODE</u>	
<input checked="" type="checkbox"/> SCREEN	<input type="checkbox"/> MATRIX
<input type="checkbox"/> SURROUND	
<input type="checkbox"/> SCREEN AND SURROUND	

To change the output mode selection, press F3 & F4 ↑ ↓. Once selection completed, press OK twice to save setting. To return to the normal operating screen, press FMT button.

8.3.4. SET DEFAULT FORMAT

This is used to program the default sound format that is enabled after the film finishes playing or after the DTS-6AD boots-up to the normal operating screen. The **factory setting** is NONSYNC. To change this selection, press MENU → SYSTEM SETUP → OPTIONS → NEXT → NEXT → NEXT. The screen below should appear:

◀ SCROLL	NEXT ▶
	BACK ▶
<u>SET DEFAULT FORMAT</u>	
<input type="checkbox"/> MONO OR EXT SR	
<input type="checkbox"/> A	<input checked="" type="checkbox"/> NONSYNC
<input type="checkbox"/> SR	<input type="checkbox"/> EXTERNAL

To select a different format, press F3 & F4 ↑ ↓. Once selection completed, press OK twice to save setting. To return to the normal operating screen, press FMT button. Now, after the film ends or after boot-up, the DTS-6AD will be in the default format that was programmed. **This default programming will not change the optical fallback setting on DTS discs.**

8.4. OPTIONAL PROGRAMMING

8.4.1. DISABLE MATRIX

This is used to disable the internal matrix decoder. To disable, press MENU → SYSTEM SETUP → OPTIONS → NEXT. The screen below should appear:

◀ SCROLL	NEXT ▶
	BACK ▶
<u>DISABLE MATRIX</u>	
DISABLE THE INTERNAL	<input type="checkbox"/> YES
MATRIX DECODER ?	<input checked="" type="checkbox"/> NO

Factory setting is NO. To change to “YES”, press F3 ↑. Once selection completed, press OK twice to save setting. To return to the normal operating screen, press FMT button.

8.4.2. REMOTE FADER OPTION

This is used to enable the remote fader. When enabled, it will disable the front panel master fader. The **factory setting** is OFF. To enable the remote fader, press MENU → SYSTEM SETUP → OPTIONS → NEXT → NEXT → NEXT → NEXT. The screen below should appear:

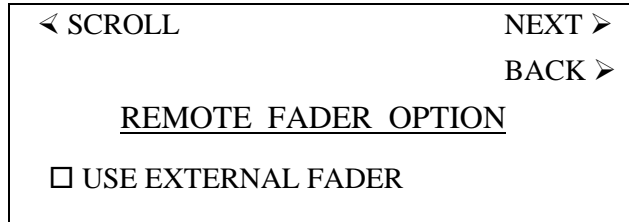

To enable the remote fader press F3 ↑. Once selection completed, press OK twice to save setting. To return to the normal operating screen, press FMT button. Now, the front panel master fader is disabled. Notice that normal operating screen has changed:

Normal Operating Screen

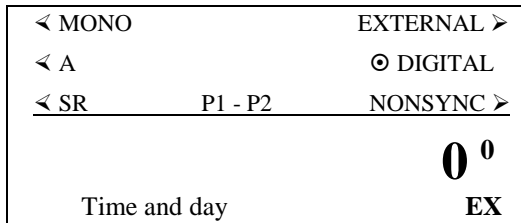

↔ level at “0” and “EX” appears

Try turning the front panel master fader. Notice that the level will not change and “EX” now appears below the small zero. **“EX” signifies that the DTS-6AD is operating in the external fader mode.**

8.4.3. USING THE TRIM FEATURE

There are two different “trim” features in the DTS-6AD. ① One is used to “trim” the volume of NONSYNC playback in the auditorium and ② the other is used to “trim” down the volume of trailers as to balance the sound level of trailers to the feature film. This is especially useful if the digital trailers are much louder than the feature. Both types of “trims” must be enabled by an external contact closure. Be aware that when the trim feature is enabled, it effects all sound formats programmed to use it. For this reason, use only when needed. The following formats can be “trimmed”: NONSYNC, External 6-Track, External NR, Mono, SR-Type, A-Type, and (DTS) Digital.

Trim value is software selectable.

- “Trailer Trim” sound formats = Mono, SR-Type, A-Type, External, and Digital overall sound level can be decreased from **0dB to -9dB**. It is programmed via MENU → SYSTEM SETUP → AUDIO → AUTOMATION TRIM. Use F7 & F8 ← → keys to select sound format. Use F3 & F4 ↑ ↓ keys to select trim value, or hold down desired format button and rotate master fader. Once set, press OK twice to save. The **factory set** “Trailer Trim” is 0dB. To return to the normal operating screen, press FMT.
- “NONSYNC Trim” overall sound level can be decreased from **0dB to -20dB**. It is programmed via MENU → SYSTEM SETUP → AUDIO → NONSYNC TRIM. Use F3 & F4 ↑ ↓ keys to select trim value, or hold down SET (F1) button and rotate the master fader. Once set, press OK twice to save. The **factory set** “NONSYNC Trim” is -3dB. To return to the normal operating screen, press FMT.

To enable either trim, P15 (or P16) “STATUS/CONTROL A” (or B) connector must be wired as shown below. Use an external switch or automation pluses to switch trim in/out (the trim will remain enabled until switched out).

DTS-6AD

<u>Function</u>	<u>Setting</u>	<u>P8/P15</u>	
Control 3 In	Trim In	Pin 4	→ to external switch or format “in” pulse
Control 7 In	Trim Out	Pin 8	→ to external switch or format “out” pulse
Digital Ground		Pin 12	→ to eternal device
Status 3 Out	Trim In	Pin 17	→ to external LED, if desired

SECTION 9 DTS-6AD SYSTEM TEST AND OPERATION

9.1. DTS-6AD SYSTEM PERFORMANCE TEST

Before attempting to complete this performance test, verify all setups are done as per the “Setup Check List” (page 4-1). All but the last three items on the list should be completed.

Tools Required: SPL meter and DTS technician’s kit.

9.1.1. DTS-6AD TEST

Power the DTS-6AD, or if powered, hit the RESET button on D740 board. After the unit boots, verify the correct sound format automatically keys in and the screen displays the correct playback level. The playback level is normally 7.0. NOTE: The DTS-6AD cannot provide 20dB of headroom when the master fader is set to a value greater than 7.0.

Channel Verification

- Load the DTS Setup disc into “Drive A” on the DTS-6AD.
- Once the disc loads, verify the DTS-6AD automatically switches to F6 (DTS) Digital format. Each program on the DTS Setup disc is announced before pink noise for that channel is played. The first program on the DTS Setup disc is LEFT channel pink noise. Notice the screen displays “SETUP LEFT CHANNEL”.

◀ MONO	EXTERNAL ▶	⇐ Setup Disc screen
◀ A	● DIGITAL ▶	⇐ Playing in DTS DIGITAL
◀ SR	P1 - P2	NONSYNC ▶
◀ NEXT	REEL# 1	TC -----
SETUP LEFT CHANNEL	7.0	⇐ Level should be 7.0

- Open the booth port-hole or go into the auditorium.
- When the LEFT channel pink noise is playing, verify sound is heard coming **only** from the left screen speaker. Also, verify that pink noise is heard **only** from the booth monitor’s left channel. This is checked by enabling only the “AMPS” and “L” buttons on the monitor panel. All other buttons should **not** be illuminated.
- Press F4 to advance to the next disc program, which is LEFT SURROUND pink noise. The screen should now display “SETUP LEFT SURROUND”. Verify sound is coming only from the left surround speaker(s) in the auditorium and booth monitor. Press F4 to advance and repeat for all remaining channels.

CD-ROM Drives Check

- Eject the Setup disc from Drive A and load into Drives B & C, one at a time. Verify the disc loads and plays in each drive.
- Remove Setup disc from the DTS-6AD.

Verify Sound Performance

- Thread the BUZZ AND BILL SHOW film through the projector and DTS reader. Load the disc into any drive on the DTS-6AD.
- Start the projector. Verify the DTS-6AD automatically switches to F6 (DTS) Digital format. Verify sound is heard in the monitor speaker.
- Verify the screen displays the DTS-6AD is playing in digital, reel #1, serial #0, present time & day, correct level, “PLAY” next to the level, and count-down of TC (timecode).

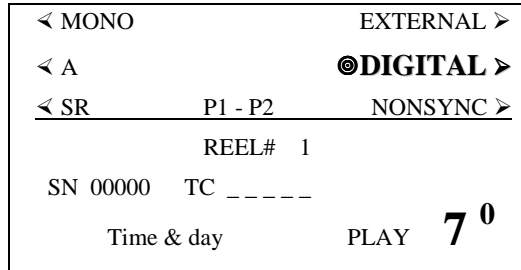

⇔ Level should be 7.0

- Go into the theater. Verify sound is in-sync, sounds well balanced and has overall good digital sound quality.
 - If the level is not correct, **verify levels using the internal pink noise – do not set levels with the Setup disc.** Perform procedure in Section 5.3.1.
 - If the sync is not correct, perform procedure in Section 7.5.
- Eject the disc and verify the DTS-6AD switches to an optical format, and that well balanced and overall good analog sound quality is heard in the theater.
- If a two projector theater, repeat “Verify Sound Performance” for Projector 2.

Verify BYPASS Operation

- Play the BUZZ AND BILL SHOW film. Remove the front display and hang it on the side hooks.
- While the film is playing in analog, switch the DTS-6AD into the BYPASS mode by setting the BYPASS switch on the D744 board to the right.

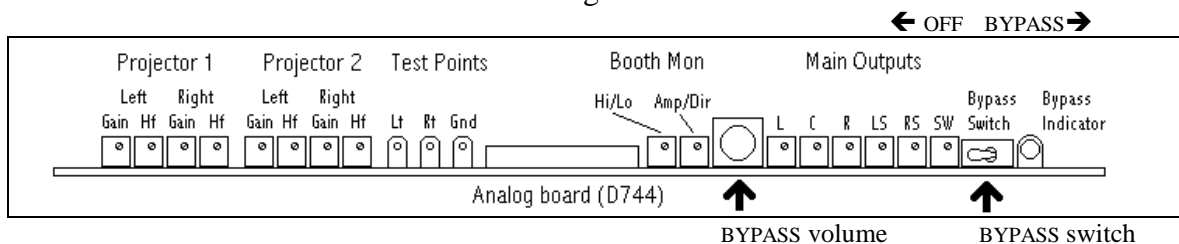

- While in the **BYPASS mode**, verify the two red BYPASS indicator lights illuminate: One light is on the D744 board and the other light is on the panel front display.
- While in the BYPASS mode, verify the sound level is good in the theater and sound is heard in the booth monitor. **Volume is adjusted by the BYPASS volume pot on D744.**
- Set the D744 BYPASS switch to “OFF”. The DTS-6AD should return to an analog format.

Verify Automatic Default Functions (from DTS disc)

- Remove the BUZZ AND BILL SHOW film from the projector. Remove disc from DTS-6AD.
- Load the DTS Setup Disc into the DTS-6AD.
- Once the left channel pink noise plays, verify DTS-6AD automatically switches to DIGITAL. Verify sound is heard in the booth monitor.
- Now, eject the disc. Verify the DTS-6AD automatically switches into A-Type (F2).
- Reload the disc into the DTS-6AD and wait for the disc to load and play. Once the left channel plays, press F4 to advance to the left surround. Wait until the left surround pink noise is heard.
- Now, eject the disc. Verify the DTS-6AD automatically switches to NONSYNC (F7).
- Repeat for all remaining channels. A list for all default programs on the DTS Setup disc is given below. Be sure they all work correctly.

<u>DTS Setup Disc</u> <u>Pink Noise Channel</u>	<u>DTS-6AD</u> <u>Default Format</u>
Left	A-Type
Surround	NONSYNC
Center	SR-Type
Right	Mono

Verify Default Functions (from DTS-6AD Menu)

While DTS-6AD is powered but not playing film, push the RESET button (located on D740 board). Verify the DTS-6AD boots to the desired sound format (for most installations, this will be NONSYNC). If another default format is desired, see Section 8.3.4.

Normal Operating Screen

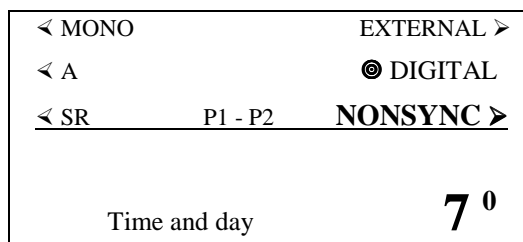

In this case, the default format is NONSYNC.

Booth Monitor

Connect RTA line out to the P3 MONITOR OUT on the DTS-6AD rear panel. Play pink noise on the center channel. Press MONTIOR center channel and turn up monitor volume. Verify the signal on the RTA is flat. If low frequency is greater than high frequency, adjust **R17 (D744 board) until a balance (high frequency vs. low) is seen on the RTA.**

Once frequency is balanced, press AMPS button in and out to verify monitor playback is equal in volume. If not, adjust **R16 until the volume balance** between AMPS (amplifier out) and direct out (from DTS-6AD) is equal (through the booth monitor).

9.1.2. Verify External Equipment Performance With DTS-6AD

The DTS-6AD master fader should be set to 7.0 for all tests.

Automation

If automation is used, run the BUZZ AND BILL Show film with the disc loaded into the DTS-6AD. Verify the automation controls sound formats when engaged.

External 6-Track Analog Sources

Dolby™ Model DA-20

- Use Dolby Digital Test Film to check its operation with the DTS-6AD. Thread the film and play it. Verify the DTS-6AD plays the film in the EXTERNAL (F5) sound format.
- Verify the sound level and overall sound quality. The DTS-6AD master fader should be at 7.0. The sound level of the Dolby Digital™ and DTS digital sound tracks should be equal.
- If volume not equal, use the “Trim” feature to make necessary adjustments, see page 8-8.

6-Track Magnetic Master

Run the master and verify the DTS-6AD plays the film back in the EXTERNAL (F5) sound format. The DTS-6AD master fader should be at 7.0. Verify the sound level and overall sound quality. If volume “Trim” is needed for magnetic master, see page 8-8.

External Microphone

Verify which DTS-6AD connector is being used for external microphone input. Press the sound format key that controls that connector and speak into the microphone. The master fader on the DTS-6AD should be at 7.0. Verify the sound level and overall sound quality. If volume “Trim” is needed for microphone, see page 8-8.

Remote fader (optional)

Connect the remote fader and enable it through the programming MENU (see Section 8.4.2.). When enabled, verify the remote fader controls the DTS-6AD volume.

NONSYNC

Connect NONSYNC source and play it. If needed, push F7 NONSYNC key. Verify the sound level and overall sound quality. If volume “Trim” is needed for NONSYNC, see page 8-8. If the sound needs to be routed to different speakers in the auditorium, see Section 8.3.3.

9.2. OPERATION

9.2.1. BEFORE THE SHOW

- Power on the sound rack and wait for the DTS-6AD to boot-up. Once booted, the screen below should appear:

Normal Operating Screen (no disc loaded)

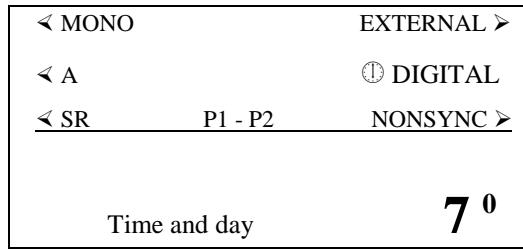

⇐ Notice symbol next to DIGITAL when no discs are loaded.



Should display present time and day

- **Thread film** through projector(s) and DTS reader. **Load DTS feature/trailer discs.** Wait for the disc(s) to load. Notice the screen change:

Normal Operating Screen (with disc loaded)

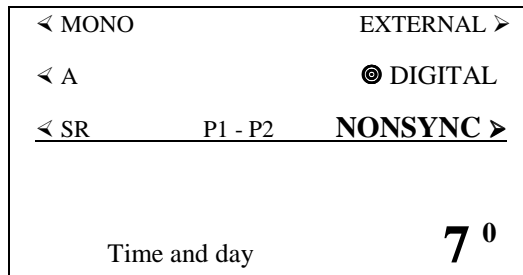

⇐ Notice symbol next to DIGITAL

⇐ Shows unit in the NONSYNC mode

⇐ Showing fader setting at 7.0

- Verify the **fader setting** at 7.0 and sound format on **NONSYNC** (if that is the “default” sound format of choice). If the fader not set for 7.0, it could be the NONSYNC volume was re-rest by software programming. If volume is OK in auditorium, leave as is. If volume not good, see page 8-8 to reset “Trim” or contact repair technician.
- If using an **external microphone**, select the format controlling the external microphone (hopefully, the installer left a label). The format depends on which input was used for the microphone. The master fader may change value via software programming. If the value needs to be reset, go to page 8-8 “Trim” or contact repair technician.

9.2.2. DURING THE SHOW

- **Run the film.** Notice the screen change:

Normal Operating Screen (playing in analog)

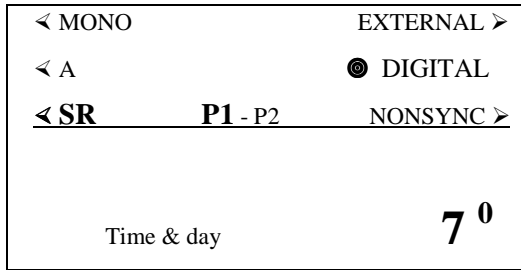

⇐ Symbol indicates disc loaded, but movie playing in analog. If no disc loaded, symbol next to DIGITAL will be ○

In this case, unit in SR-Type, fader at 7.0, and projector 1 is active.

Normal Operating Screen (playing in DTS digital)

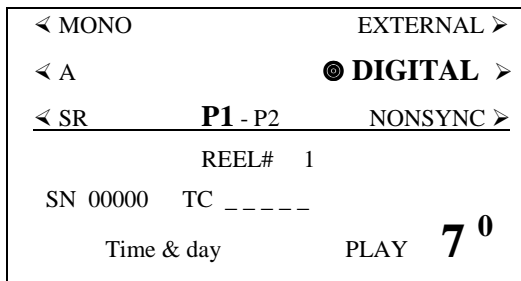

⇐ Arrow appears next to DIGITAL when movie playing in DTS digital

In this case, unit in DTS digital, projector 1 is active, fader is set for 7.0, and timecode is running. Timecode will also enable the display of film serial number and reel number. The DIGITAL format cannot be selected unless the DTS-6AD receives timecode.

- **If playing in DTS digital**, the sound format will automatically change to DIGITAL. The green timecode LED should illuminate (on display panel). In most cases, the fader should be at 7.0.
 - * Once DTS digital feature is over, the sound format will automatically switch to NONSYNC.
 - * If DTS digital fails, the sound will automatically switch to an analog format.
 - * If the DTS-6AD experiences a board failure, it will automatically switch to BYPASS.
 - * **CAUTION:** Do not open drives while film playing in digital, will cause DTS-6AD to default to analog.
- **If playing in analog**, the sound format should be changed by automation or the correct sound format switch must be pressed by projectionist. In most cases, the fader should be at 7.0.
- Adjust **monitor** volume for comfortable listening level in the booth. Select channels to monitor by pressing appropriate buttons. Select INT SPK if using internal speaker.

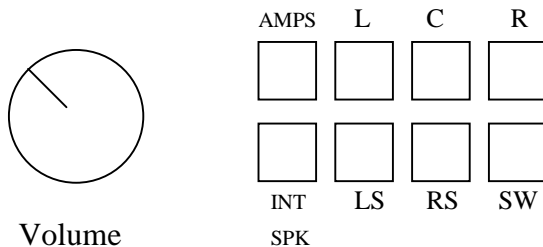

⇐ Press channels to monitor in booth

9.2.2. DURING THE SHOW (continued)

- **Go into the theater and listen.** Verify good sound quality.
 - * If **volume too loud**, turn down master fader until a comfortable listening level is achieved.
 - * If the **digital sound is out-of-sync**, press the SR-Type (F3) sound format button and eject DTS discs. Wait for show end to make necessary adjustments. Verify correct threading pattern through the projector. If pattern is correct, see Section 7.5, or contact repair technician. Once setting fixed, reload DTS discs.
 - * If the **digital sound seems bad**, press the SR-Type (F3) sound format button. If sound quality is restored, eject discs and call repair technician.

• **Film Breaks and Edits**

In the DTS digital playback mode, the unit will automatically track any length edit. A 30 millisecond cross fade makes the edit transparent. Verify the DTS-6AD switches to DTS digital format after show re-start.

• **BYPASS Mode Operation**

The DTS-6AD will automatically switch into BYPASS mode if an internal failure occurs in the unit.

If required, the user may switch the DTS-6AD the into BYPASS mode by setting the D744 “BYPASS” switch to the right.

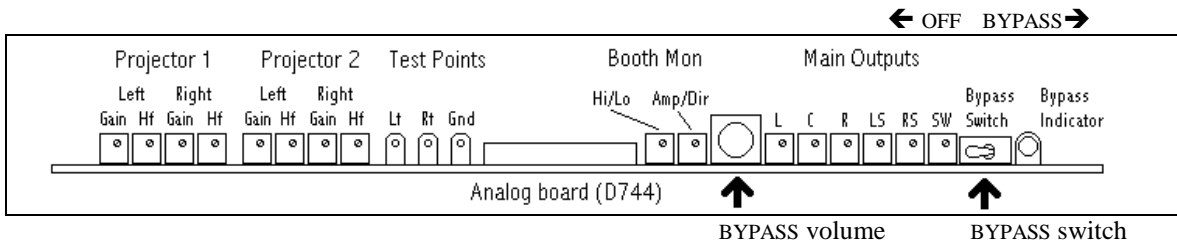

While in the BYPASS mode:

- Two red LEDs - one on the D744 board and another on the display panel - will illuminate.
- The signal from the solar cell will be routed to the screen outputs.
- The “BYPASS volume” pot on D744 is used to adjust volume.

-continued-

9.2.2. DURING THE SHOW (continued)

• **Remote Fader Operation**

When film is playing via remote fader, the screen will display:

Normal Operating Screen

< MONO	EXTERNAL >	
< A	● DIGITAL	⇐ DTS discs loaded
< SR	P1 - P2	NONSYNC >
Time and day		0 ⁰
		EX ⇐ External fader enabled.

“EX” signifies that the DTS-6AD is operating in the external fader mode. Front panel volume will display “0” because the front panel fader no longer controls volume.

If this screen appears and the front panel master fader is desired for volume control, reprogram setting through MENU. See Section 8.4.2. Once disabled, the “EX” should disappear, the front panel master fader will control volume, and a “volume” number will display.

• **Dual Projector Operation**

For theaters using two projectors and are playing movies in **DTS digital**, the DTS-6AD will automatically make a sound change-over when the first frame of picture timecode is read on the upcoming projector. DTS digital sound changes independently of the projector’s dower position. Adjustment of the roll-down on the projectors may be necessary to maintain a seamless change-over.

For theaters using two projectors and are playing movies in **analog**, the DTS-6AD needs to see analog signal from each projector. Switching between projectors for analog sound is done manually or through an automation system. The front panel screen will display which projector is the DTS-6AD is reading.

Normal Operating Screen (playing in analog)

< MONO	EXTERNAL >	
< A	● DIGITAL	
< SR	P1 - P2	NONSYNC >
Time & day		7 ⁰

⇐ Either P1 or P2 will darken, signifying which projector is active.
In this case, its Projector 1 and the DTS-6AD is playing in DTS Digital

9.2.3. AFTER THE SHOW

- Unless programmed otherwise, the DTS-6AD will go to NONSYNC at show end.
- Clean projector gates and optics. Use compressed air or a Q-Tip to clean off DTS reader lens.
- Rethread film through projector and DTS reader for next show.
- If **show changing**, remove DTS discs and return them with the film. Thread up new show and load new discs.

- **Maintenance**

The **timecode reader** lens should be blown off with compressed air or wipe with a clean dry Q-Tip after each show to remove dust. Do not moisten the Q-tip with any cleaning solution, it can seep into the optics and damage them.

Movie/trailer discs should be cleaned once a week to prevent dirt build-up. To clean, use a clean dry cloth and wipe from the inside straight out. Do not wipe in a circular motion.

CD-ROM drive drawers should be kept close to prevent dirt from getting inside.

CD-ROM drive cleaning discs should be used once a week to clean away dust/dirt build-up on the internal laser lens. Purchase a cleaning disc from any computer store. A “CD” cleaning discs will not work. Be sure to buy a **CD-ROM** lens cleaner disc. The cleaning brush (on the cleaning disc) must be close to the center hole. To use, insert the disc into each drive 5 times. **Never blow compressed air into the CD-ROM drives as the internal mechanisms may be damaged, voiding warranty.**

Remember to keep the DTS-6AD **side vents clear** to prevent over-heating and to keep dirt from being sucked in through the CD-ROM drives.

NOTES

Thank you for choosing DTS !

SECTION 10 WIRING DIAGRAMS

This chapter contains the following diagrams:

WD-E237	DTS-6AD System Wiring Diagrams
Sheet 1	Balanced and Unbalanced audio out and monitor in for wideband applications using external crossovers.
Sheet 2	Status/Control, SPDIF, RS-232.
Sheet 3	Timecode, External noise reduction, Balanced and Unbalanced Monitor In for Biamp Applications.
Sheet 4	Auxiliary power In, External 6-track Analog In, NONSYNC, External (monitor) Speaker, Remote Fader, Optical In.
Sheet 5	Hearing Impaired, Balanced and Unbalanced Audio Out for Biamp Applications.
SD-E238	Remote Fader Schematic Diagram
TI-D435	Timecode Reader Cable Wiring Diagram

NOTES

Thank you for choosing DTS !

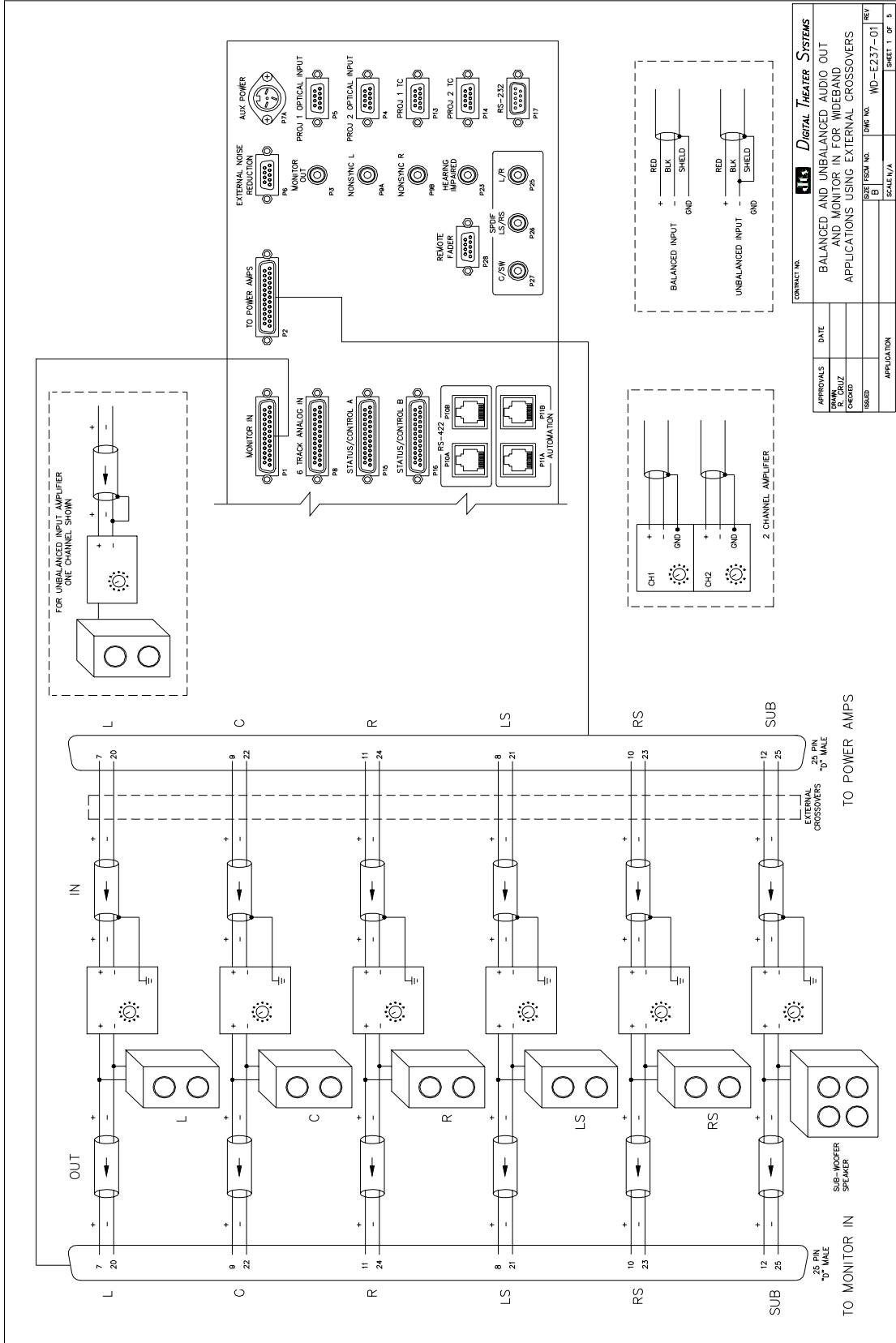

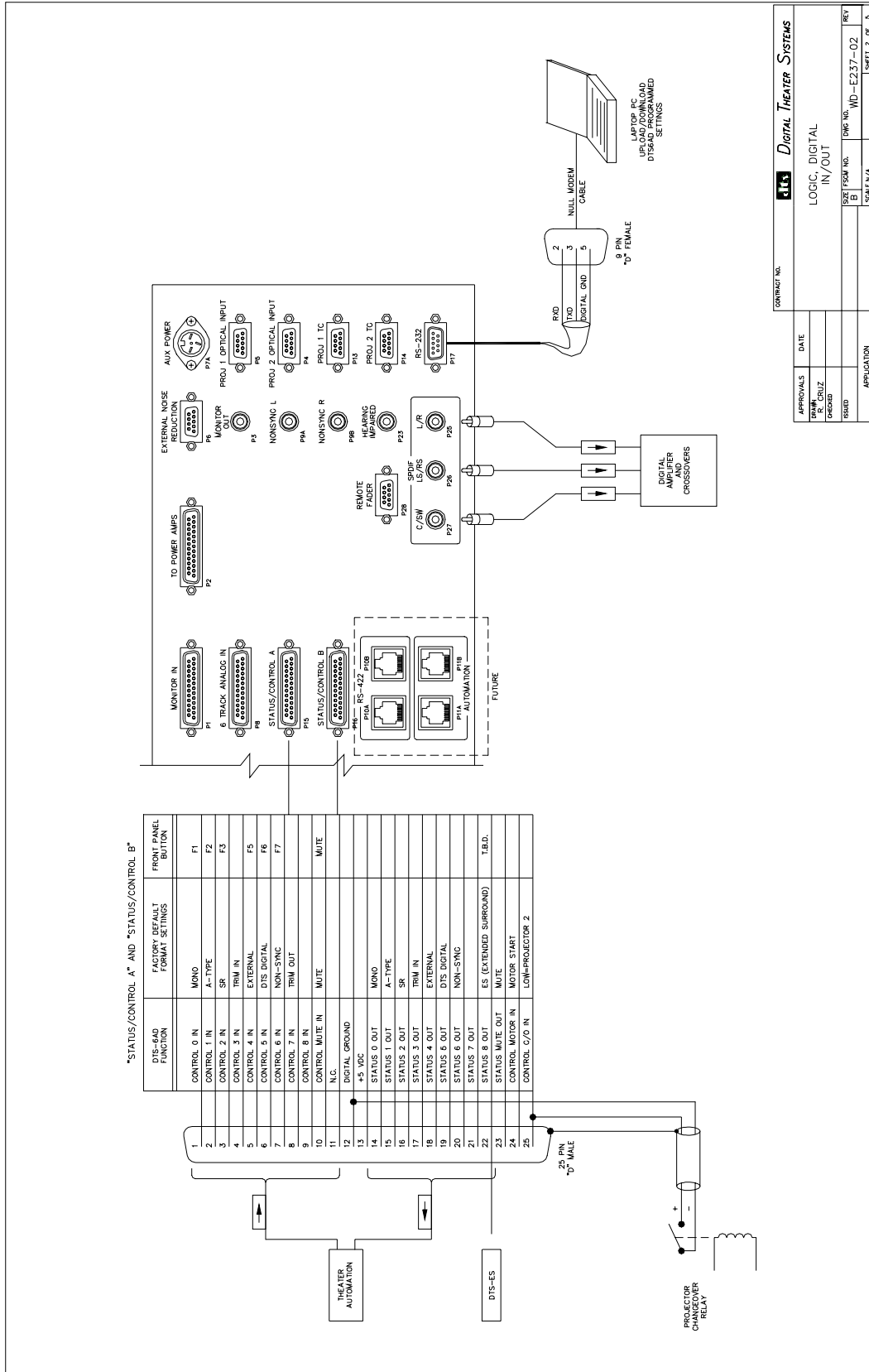

APPROVALS	DATE	CONTRACT NO.	Digital Theater Systems
BY: R. CRUZ			
DESIGNED			
TESTED			
DATE TSOAM NO.	DWF NO.	DWF NO.	WD-E237-02
B			
APPLICATION			
			SHEET 2 OF 3

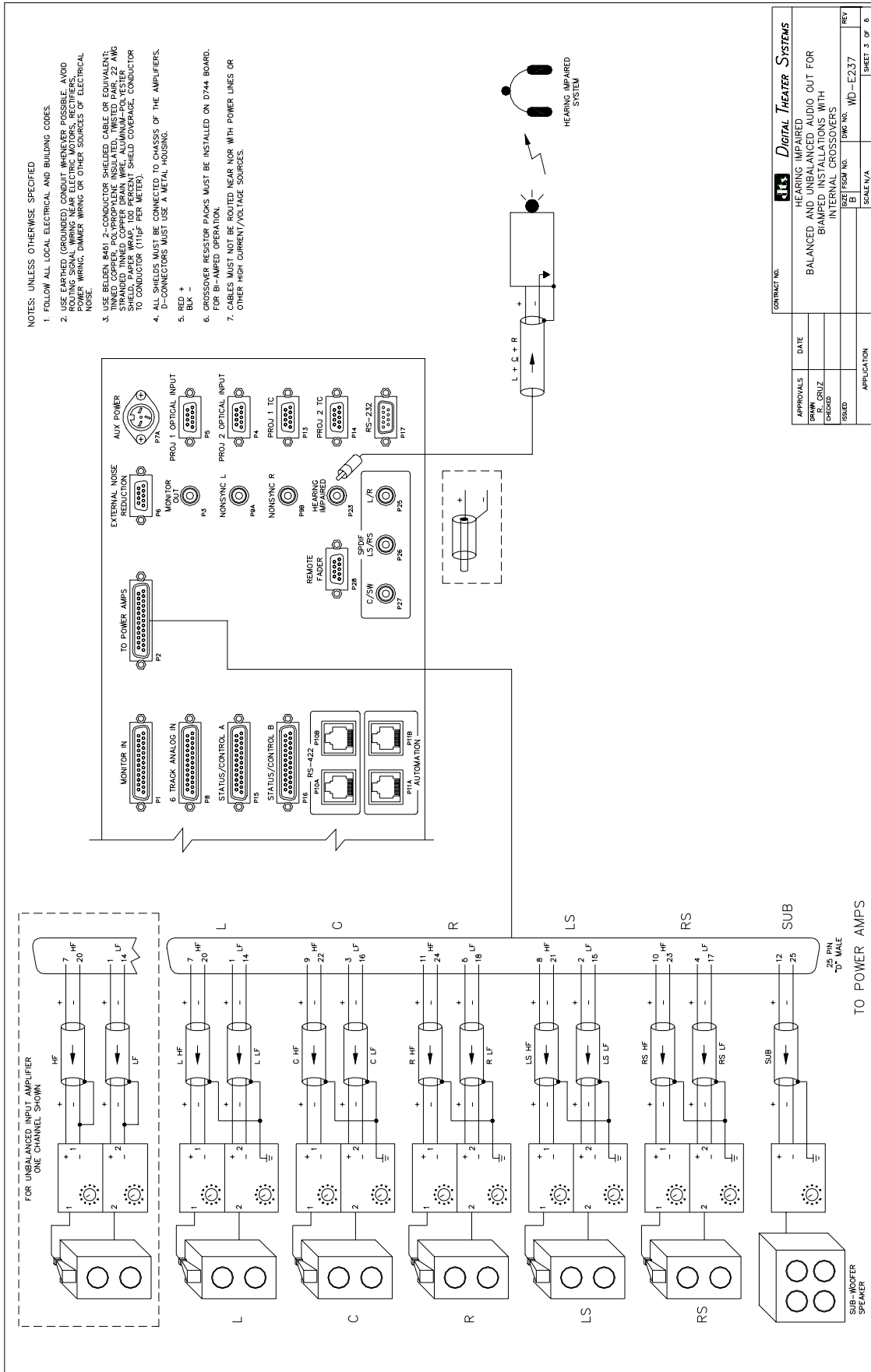

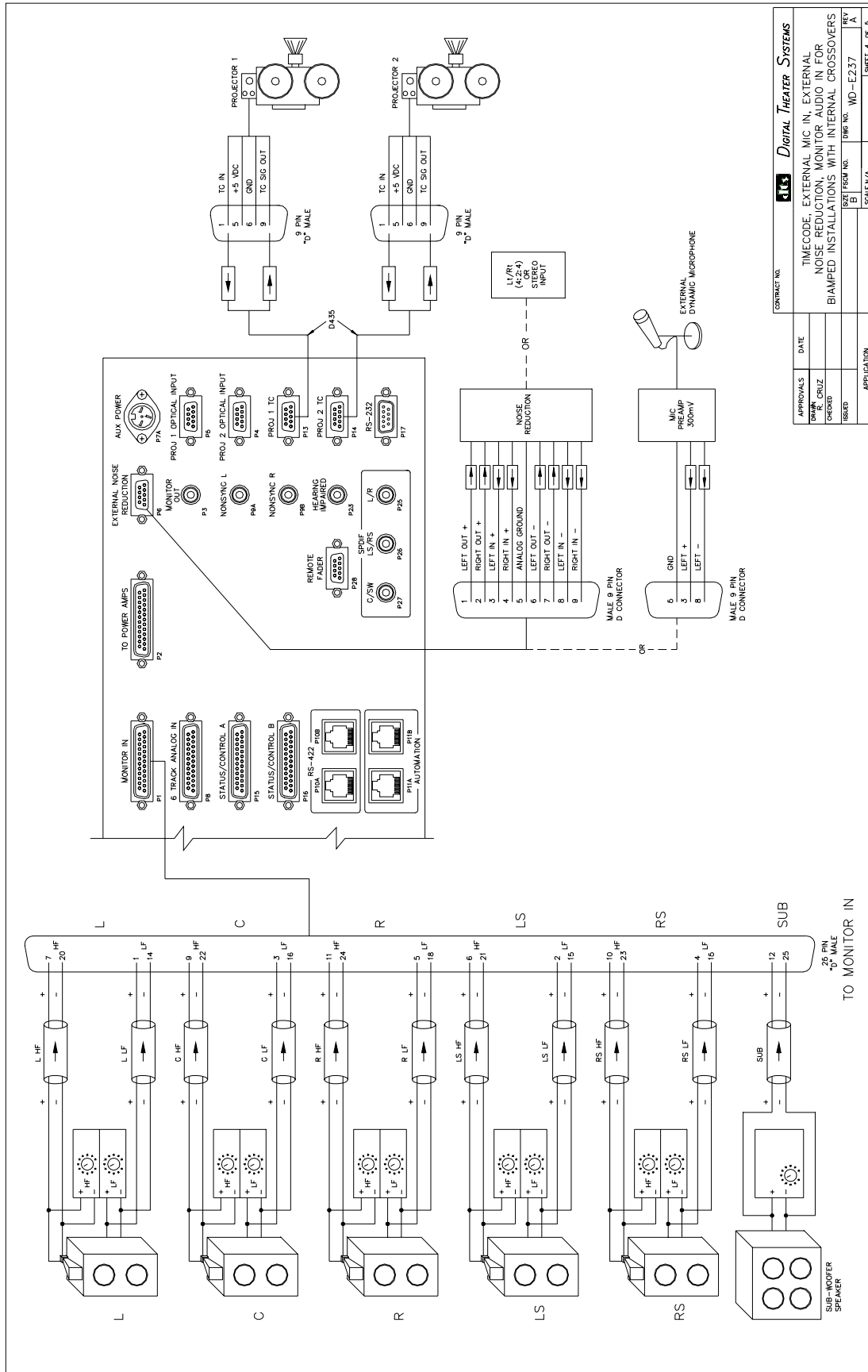

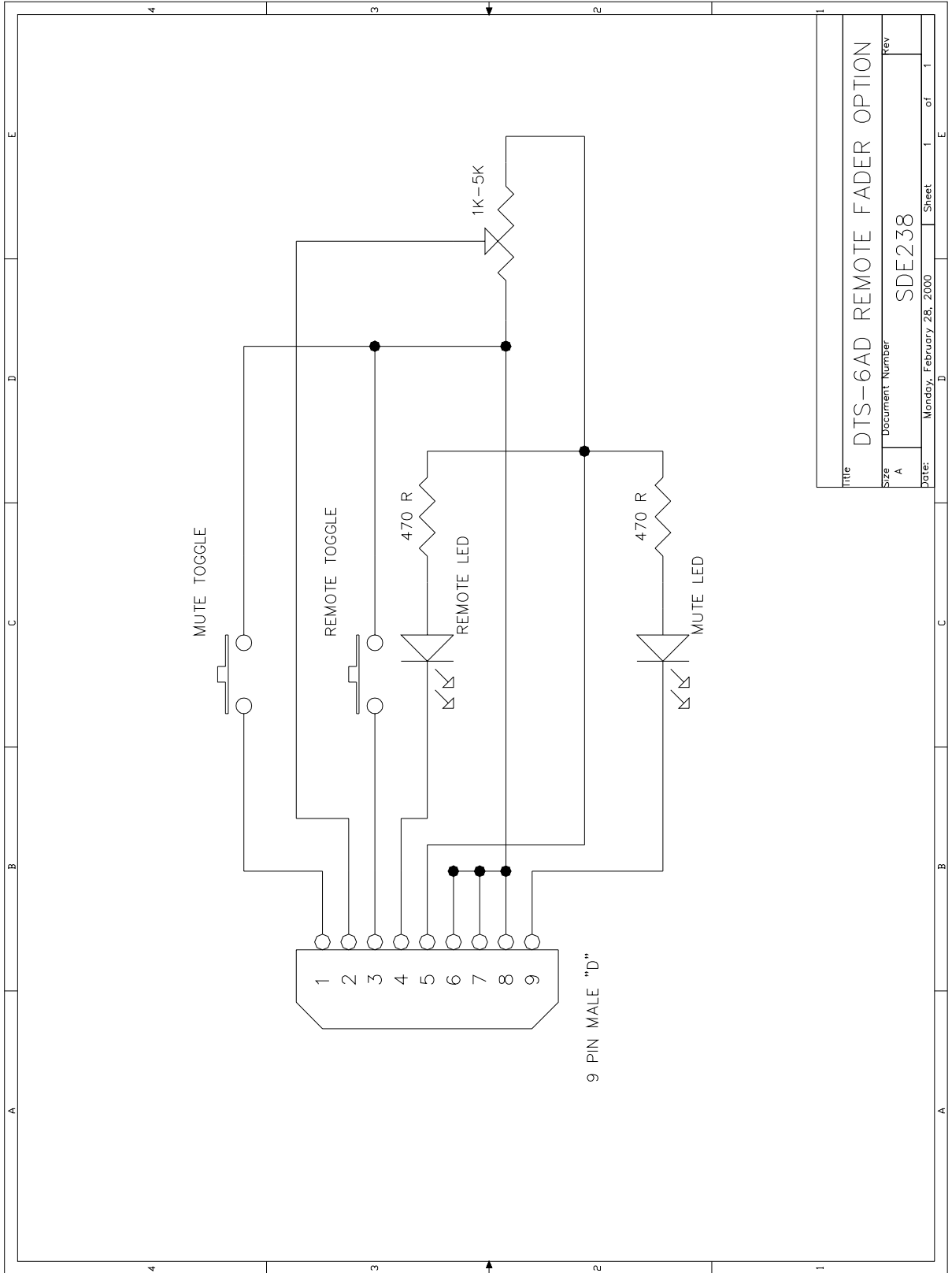

Title	DTS-6AD REMOTE FADER OPTION		
Size	Document Number	New	
A	SDE238		
Date:	Monday, February 28, 2000	Sheet	1 of 1

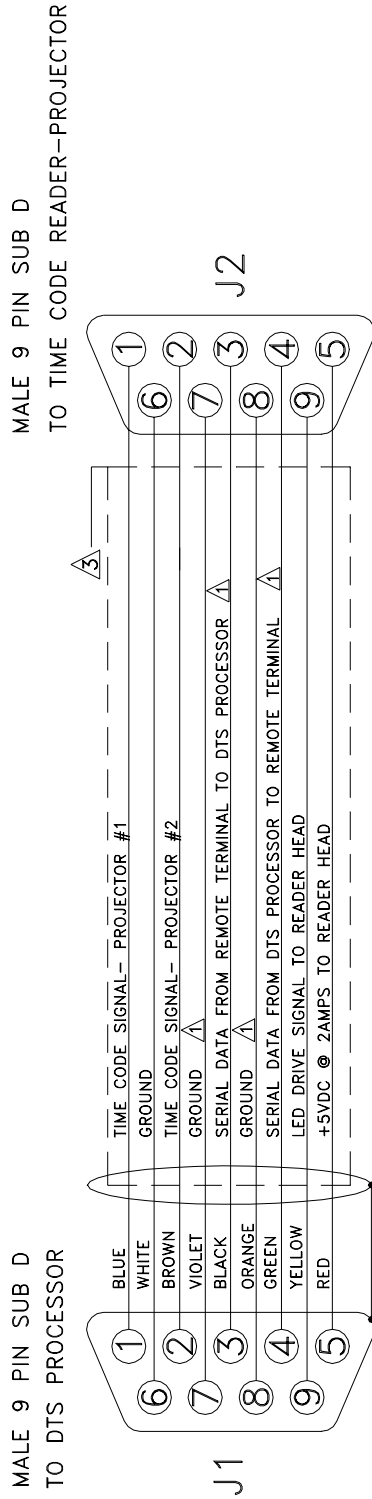

④

CABLE SUFFIX NUMBER	CABLE LENGTH
-01	30'
-02	40'

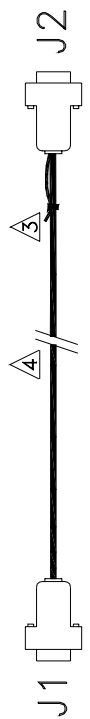

STANDARD LENGTH CABLE = 30'

NOTES

- ① THIS CONDUCTOR IS NOT NEEDED FOR TIME CODE READER TO OPERATE.
- ② VERIFY WIRE COLORS—SOME CABLES MAY VARY.
- ③ IF PROBLEMS READING TIME CODE ARE EXPERIENCED, CONNECT SHIELD WIRE TO A GROUND ON THE PROJECTOR.

TITLE: TIME CODE READER CABLE	
DATE: 02/20/01	APPROVED:
SCALE: 1/8"=1'	DRAWN: M38RZAT
DTS	
DIGITAL THEATER SYSTEMS	
5171 CLARETON DR	
AGOURA HILLS, CA 91301	
COMPUTER FILE NAME:	DWG. NO.:
TID435.DWG	TI-D435

SECTION 11 TROUBLESHOOTING AND UPDATING

11.1. INSIDE THE DTS-6AD

- **D744 ANALOG BOARD**

This board contains all the analog circuitry, BYPASS & monitor circuitry, analog signal test points, individual level control trim-pots for all 6 channels, and stereo signal adjustment trim-pots.

- **D741 DSP BOARD**

This board contains digital signal processing (logic) circuitry and IC1 firmware chip.

- **D740 CPU BOARD**

This board contains the RESET button, memory & software files, and U8 & U9 firmware chips.

- **DISPLAY PANEL (D743 board)**

The screen displays the current state of the unit. During normal operation, the display shows which format the movie is showing, which projector is active, time & day, and volume level.

Normal Operating Screen

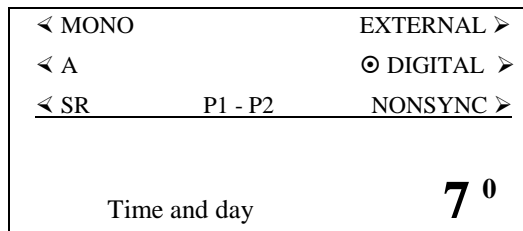

- Time & day programmed via software MENU, see Section 4 “CLOCK”.
- If boot-up sequence fails, hit RESET button on D740. If boot-up fails again, contact service technician.

During boot-up, the screen displays the BOOT version number and boot-up sequence. If the unit does not complete the boot-up sequence, the screen will display the failure.

BOOT-UP SCREEN

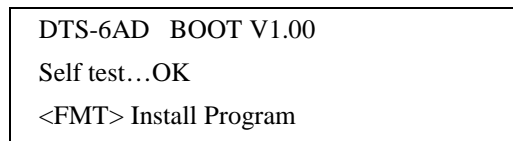

⇐ showing V1.00 as firmware version

- Firmware version reflects what is installed in DTS-6AD.

-continued-

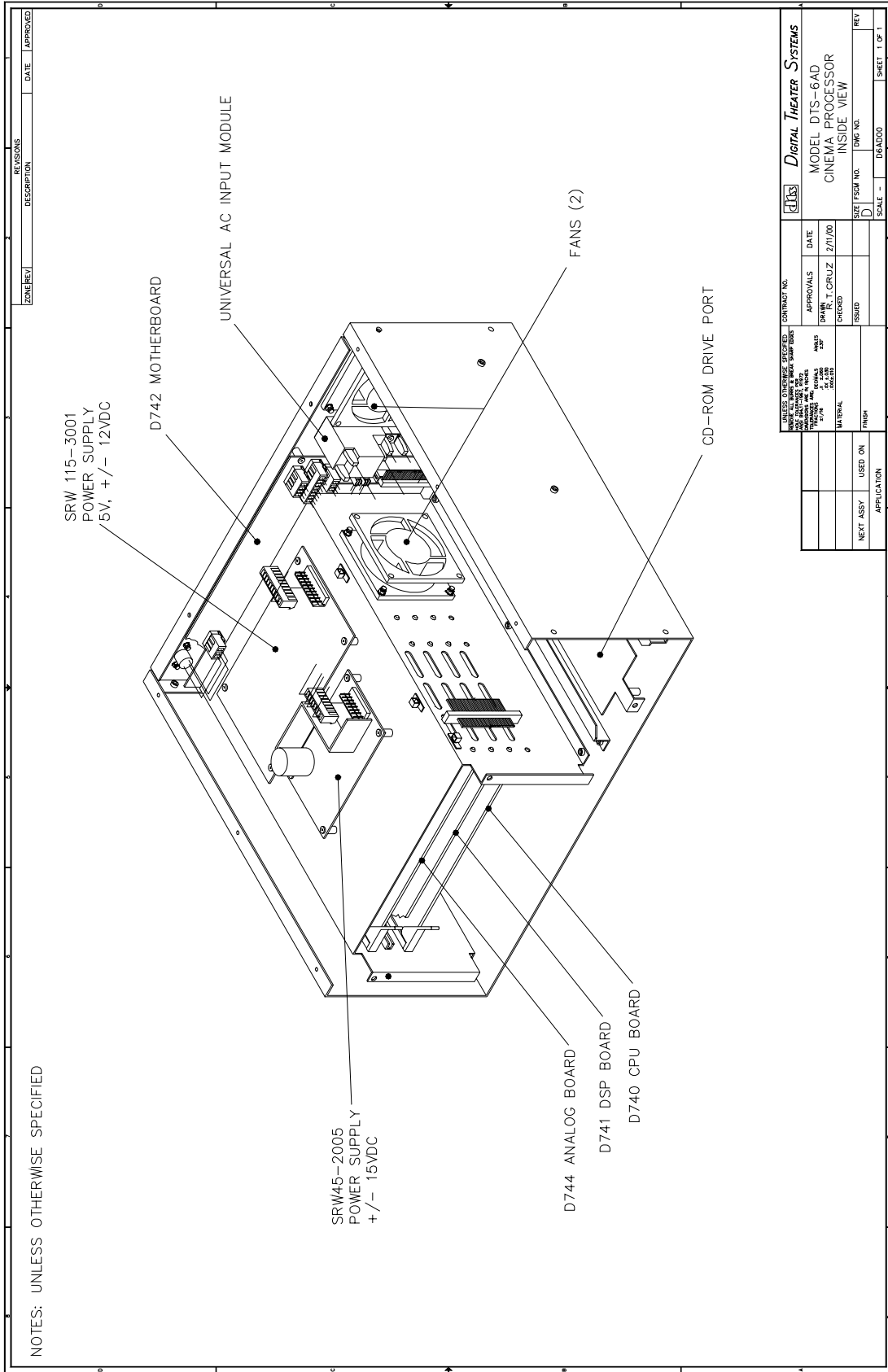

ALL TESTS CONDUCTED SUCCESSFULLY PARTS ALL IDENTICAL TO ORIGINALS WORKING ORDER MATERIALS DATE: 7/11/00 BY: T. CRUZ		CONTRACT NO. APPROVALS CHECKED ISSUED	DATE 7/11/00
NEXT ASSY USED ON APPLICATION		DTS Digital Theater Systems MODEL DTS-6AD CINEMA PROCESSOR INSIDE VIEW	
SIZE FROM NO. D		DWG NO. DEADDD	
SCALE 1 OF 1		SHEET 1 OF 1	

11.1. INSIDE THE DTS-6AD (continued)

• CD-ROM DRIVES (3)

Three CD-ROM drives allow 5 hours DTS digital playback time. Discs may be loaded into the DTS-6AD in any order. All the drives are assembled into a sub-chassis that is connected to the DTS-6AD mainframe. Each drive is specifically addresses for its location in the DTS-6AD.

• D742 MOTHER BOARD

Holds most rear panel connectors and all boards plug into this board.

• POWER SUPPLIES (2)

There are two supplies in the DTS-6AD. Both connect to the **universal AC input module** that is rated for 85 VAC to 264 VAC, between 47 Hz and 64 Hz.

- SRW45-2005 has an output of +15 VDC, -15 VDC and provides power to the D744 analog board.
- SRW115-3001 has an output of +5 VDC, +12 VCD, -12 VDC and provides power to the D740 CPU & D741 DSP boards, and CD-ROM drives.

External **fuse** is 2A slow blow, 3AG. Will accept 5 x 20mm.

P7A AUX (rear panel) connector is available for **external power supply** input. This supply will be used if the internal supplies fail. The external supply should be rated at 2 amps and for an output of ± 12 VDC to ± 15 VDC.

• COOLING FANS (2)

Helps to prevent overheating of the DTS-6AD. There are two different fans in DTS-6AD. One on the back panel is the more powerful of the two. It helps maintain good air circulation in the unit. Part description: EBM 8412, 12VDC, 0.8watts, 3.15" square at 1" deep, 33CFM, 35dBA.

The other fan, next to the card cage, is there to cool parts on the D741 DSP board. Part description: EBM 8412L, 12VDC, 0.8watts, 3.15" square at 1" deep, 21CFM, 21dBA.

If fan replacement is necessary, the CFM (cubic feet per minute) rating must be maintained. Also, to ensure good air flow, the side air vent must be clear.

11.2. USER TROUBLESHOOTING TIPS

It's best go into the theater and listen to the first few minutes of the show, especially new shows. Listen to the level and general quality of the sound. The sound track should be in sync with the picture and played at a comfortable level. Even though not every scene will have surround material, listen for the surround speakers. Most opening musical sequences have surround information. **Be sure the movie discs match the film playing.** Feel free to contact DTS and ask for help (see Section 11.6).

- **No discs came with the print**

Contact the **film's distributor** and ask for disc(s). A film that runs less than 90 minutes will have only one movie disc - it should also be labeled "one disc only". Most movies will have two discs. Features running over 3 hours & 20 minutes will have three discs.

- **Film not in sync or doesn't sound right**

- If playing in DTS digital, switch the DTS-6AD to analog. Take out the movie discs and wait for intermission. **Do not attempt to remedy sync problems while playing in DTS digital.**
- During intermission, check the delay (offset) setting. Verify film path is correct and the same used as when DTS sync delay was measured. Hopefully, a threading map was left for the projectionist. If sync must be re-measured, see Sections 7.3 and 7.4, or call service technician.
- Once delay is reset, load the movie discs and try them again at the next show. If sync still not correct, play film in analog, and call service technician.

- **Volume too loud/soft**

Adjust DTS-6AD master fader as needed. If auditorium sound level jumps between sound format changes, contact service technician and request an alignment. The goal is to set the master fader once (usually at 7.0) and then not touch it again.

- **DTS-6AD won't automatically switch to F6 DTS Digital Format**

- **Verify movie discs** are loaded into the DTS-6AD. Push CD-ROM drive's EJECT button. If no discs loaded, find the movie discs and insert them into any of the drives.
- Verify movie disc title matches the movie projected. If the title doesn't match the film, the discs will not play. Find the correct movie discs and insert them in the drives. Load **only one film title at a time**. After the discs are loaded, they should play.
- Verify the green **LED on the reader** (on projector) is consistently illuminated while the movie is running. If the LED is dark, then verify the film is threaded through the DTS reader and that the film has a timecode strip (located between picture and analog sound track). If **no timecode** (dots & dashes) strip is seen, call the film's distributor and request a DTS print. If the **timecode blinks**, refer problem to your service technician.

- **DTS Empirical Disc will not play**

A software update is needed, contact your service technician and request an update.

- **Some MENUs discussed in manual do not appear on screen**

A software update is needed, contact your service technician and request an update.

-continued-

11.2. USER TROUBLESHOOTING TIPS (continued)**• Switches in & out of DTS digital**

- The DTS-6AD will automatically default to analog when the unit does not see good timecode for four seconds. Verify the green LED on the DTS reader is consistently illuminated while the film is running. If the light on any **CD-ROM drive is on solid**, it means it cannot read disc. Try swapping discs.
- If the TC LED on the DTS-6AD or **reader is blinking**, gently squeeze the film between two fingers as it exits the reader head. Do the same at the entrance of the reader. If the LED stops blinking and maintains a steady glow, this indicates that more tension is needed. Tension is added by repositioning the auxiliary flanged roller on the reader so that it has maximum contact with the film or by adding additional rollers. Verify all the gears in the projector are in good condition.
- Use compressed air to blow off the reader's lens, but **never adjust the lens**.
- Never disturb the sticker on the reader's center roller. **Make no adjustments on the reader** (unless directed by DTS engineers).
- Attach the **grounding jumper** from the timecode cable to the projector. See WD477. Easiest location for attachment is to the screw that secures the timecode cable to the reader. The reader's housing must be electrically connected to the projector housing. Verify with an ohm meter. The jumper is needed for projectors that are not properly earth grounded.
- If the drop-out occurs during the same place(s) in the movie, replace the reel(s).
- Do not put any sound format **cues** on film within timecode.
- Do not use **leader** with timecode elsewhere, as it will cause a false start on the player.
- Switch DTS-6AD to play in analog and call your service technician.

• What do I do with DTS discs after the movie finishes its run?

Simply return the movie discs with the film to the depot. Put the discs back in the DTS plastic reel and load it into the film can.

11.3 TECHNICIAN TROUBLESHOOTING GUIDE

11.3.1. DISPLAY ANOMALIES

The correct boot-up sequence is shown below:

Display will show:

DTS-6AD BOOT V__ Self test...__

⇐ displays installed firmware version
⇐ if passes, will display “OK”

And then,

DTS-6AD BOOT V1.00 Self test...OK <FMT> Install Program

⇐ showing V1.00 as firmware version

And then,

DTS logo Characterizing PLL.

And then,

DTS logo Initializing DSP.

And finally,

< MONO	EXTERNAL >
< A	⊙ DIGITAL
< SR	P1 - P2 NONSYNC >
Time and day	7 0

⇐ Normal Operating Screen

The internal speaker will remain enabled. The left, center, right AMP buttons will enable.

- If boot-up sequence fails, hit RESET button on D740. If boot-up fails again, please see below for probable causes and suggestive action.

◆ **On-screen MENU selections missing or added.**

Due to a change in software. Contact DTS for current software version. Use “Version” screen (Section 2.2.2) to determine software version in a particular DTS-6AD. If an update is needed, contact DTS.

-continued-

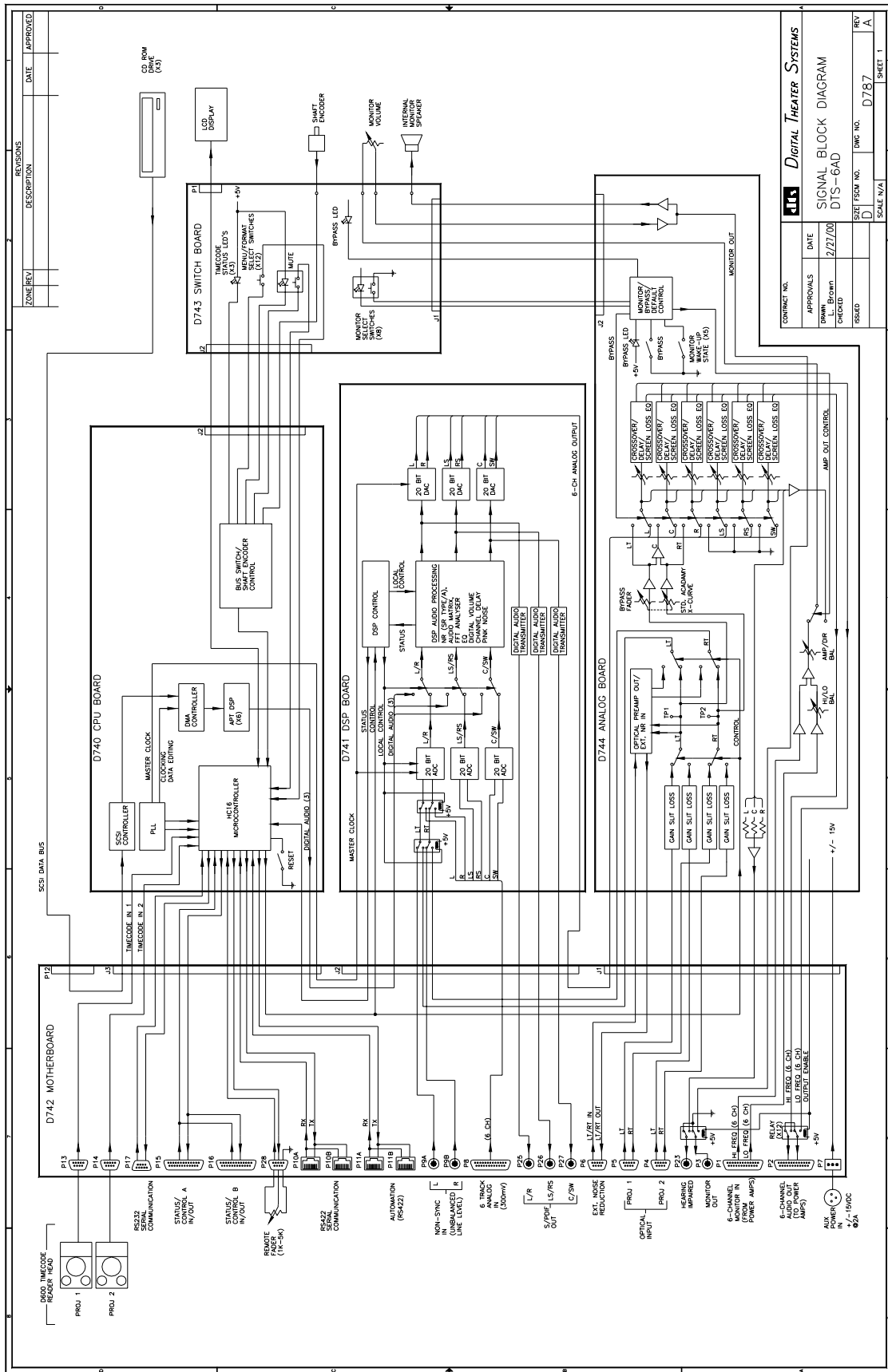

**** diagram showing signal path ****

Back side

11.3.1. DISPLAY ANOMALIES (continued)

❖ Blank Display

- Power off unit and hang display. Verify cables correctly plugged into display. Push cables onto connectors. Push D740, D741, and D744 into connectors and lock their tabs in place. Power unit and try again.
- Power off unit and remove display. Try swapping display with another. Power unit and try again.
- Power off unit and remove display. Try swapping D740 CPU board. Power unit and try again.
- Use a multimeter to verify power supply output.

❖ Screen-reported Failures

```
00000000000000000000000000000000
00000000000000000000000000000000
```

⇐ D741, DSP board problem
Swap out D741, DSP board

```
MEMORY CORRUPTED
KEY OPTIONS
    FMT  CLEAR MEMORY
    OTHER IGNORE
```

⇐ Pressing FMT key will clear all settings
⇐ Press any format key to ignore.

Memory corruption can occur from a component failure on the D740 board. If, after selecting “ignore”, the failure re-occurs, obtain setup files saved on disc (hopefully, the installer saved the setup files on a floppy disc). If a disc is not available, then the **DTS-6AD must go through an entire setup procedure after FMT is pressed or if is D740 board replaced.**

```
DSP FAILURE
```

⇐ Swap out D741, DSP board

```
ERROR SYSTEM NOT LOADED
```

⇐ System software failed, obtain System Software Disc from DTS. Load software as per Section 11.4.

❖ Unit Spontaneously Resets Or Screen Display Is Frozen

- Verify output cables are not routed with power cables or near any high voltage/current source. Keep output cables away from projector motor and power cables/sources. Cables must be shielded.
- Verify D741 & D704 are both pushed into their connectors. Verify display cables are connected tightly.
- Try swapping out D740 board.

-continued-

11.3.1. DISPLAY ANOMALIES (continued)

❖ No volume control

- Are power amps on? Master fader may be programmed in remote mode.

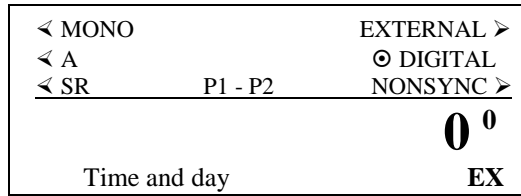

⇨ Remote Fader Mode Screen

⇨ Level at zero and “EX” displayed

- If in Remote Fader Mode and want to restore front panel master fader, press MENU → SYSTEM SETUP → OPTIONS → NEXT → NEXT → NEXT → NEXT. The screen below should appear:

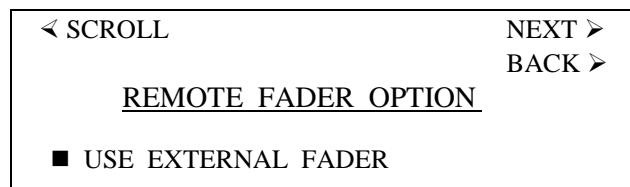

⇨ Remote Fader Option Programming Screen (remote fader shown enabled)

- To disable remote fader mode, press F4 ↓ so that the box next to “USE EXTERNAL FADER” is not highlighted. Once selection completed, press OK twice to save setting. To return to the normal operating screen, press FMT button. Operation of the front panel master fader should be restored.

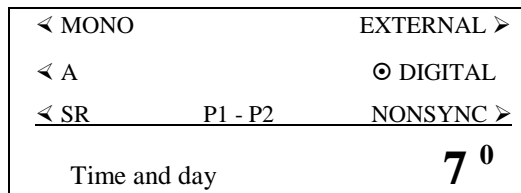

⇨ Normal Operating Screen

❖ Blank Display.

- If the unit continues to function, replace D741 board.
- If the unit will not function, switch to BYPASS (switch on D740 board).

11.3.2. POWER ANOMALIES

❖ DTS-6AD Seems Dead.

- Using a multimeter to verify output of power supplies. Replace any bad power supply. SRW45-2005 is ±15 VDC, SRW115-3001 is +5 VDC and ±12 VDC
- If no output seen, verify AC input. If AC is ok, replace bad supply. If no AC seen, is power switch on? If power switch on and no AC at switch, verify AC input to DTS-6AD. If AC ok, replace universal AC input module.

❖ Intermittent Power

- Verify the two cooling fans are rotating. Are fans plugged into motherboard? Are fans getting power? If yes, replace any fan not working.
- Verify side vents are not obstructed.
- Verify AC input is good and power switch is working properly.
- Use a multimeter to verify output of power supplies. Replace any bad power supply, SRW45-2005 is ±15 VDC, SRW115-3001 is +5 VDC and ±12 VDC

11.3.3. LOGIC ANOMALIES

❖ **Movie won't play in DTS digital sound, DTS-6AD not automatically switching.**

- Are **discs** loaded into player?
 - Does the discs match the film playing?
 - Will a DTS Setup disc work?
 - If yes, then try another set of movie discs and hit the REST button on D740 board. Try again.
 - If no, try replacing D740 and D741 boards and try again. Replace any bad board.
- Enter "**Status**" screen to see how the unit is performing. See Section 8.2.
- Are the **drives** working properly?
 - Look at the lights on **CD-ROM drives** themselves. They should blink sporadically when their disc is being read. If the light is on solid, this means the drive cannot read the disc. Try another disc.
 - If the problem goes away, the original **disc** may be bad. Inspect disc.
- If **disc needs cleaning**, wipe it with a clean dry cloth from the center straight out. Load disc back into unit and try again. If disc fails again, try playing it in another drive. If the problem goes away, then the drive is suspect. If the problem continues, then the disc should be replaced.
- Be sure the theater is not using **old trailer discs**.
- If the drive seems bad, try cleaning it. Use a CD-ROM Laser Lens Cleaner (disc). This will clean off the laser's window. This disc can be purchased at any computer store. We recommend "KleenLens" made by AudioSource™. If cleaning the drive doesn't help, replace drive. See page 2-6 that shows how to remove and set address jumpers for drives.
- Is the **TIMECODE light on solid**?
 - If not on, is the film threaded through the DTS reader? Is DTS timecode on the print?
- Is the **reader's red LED** (inside the lens) on?
 - If **not**, the reader isn't getting 5 volts DC from the DTS-6AD. Verify the TC cable connection to reader. Check cable's pin-to-pin continuity. Check for shorts or opens in cable. Check for 5v DC output to the reader. See WD477 for wiring details.
 - Try swapping the reader with a known good one.
- Is the **reader's green LED** on?
 - If not on, attach the **grounding** jumper on the reader's timecode cable to the projector. Easiest place to do that is to attach to the screw that secures the timecode cable to the reader head. The reader's housing must be electrically connected to the projector housing. Verify with an ohmmeter. This is needed for projectors that are not properly grounded. See WD477 for details.
 - If grounding the projector doesn't help, try swapping the reader with a known good one.
- If the **TC light is blinking**, see "BLINKING TIMECODE READER LED".
- If the reader's **green LED is very dim**, replace the reader.
- If re-starting after film break, some automation systems may switch the CP out of the digital format. If this occurs, it will be necessary to reselect the digital format manually.

❖ **Sporadic Operation**

- Enter the "Status" screen (Section 8.2). Log information on screen and contact DTS Technical Support (see Section 11.6).

❖ **Unit will not remember programmed trim levels**

- Needs software update. Contact DTS Technical Support and request a "System Disc".

❖ **After playing trailers in DTS digital, unit will not play feature in DTS digital**

- Needs software update. Contact DTS Technical Support and request a "System Disc".

-continued-

11.3.3. LOGIC ANOMALIES (continued)

◆ Switching in & out of DTS digital during movie.

The sound format should automatically default to analog when the DTS-6AD does not see timecode for four seconds. Verify the green LED on the DTS reader head is glowing brightly and steadily while the film is running. The DTS-6AD player will also default to an analog format if the timecode is sporadic or the DTS movie discs cannot be read.

- Defaulting during the same place in the movie.
 - Try moving discs to another drive. If the problem follows the drive, the drive is suspect. If the problem follows the disc, the disc is suspect.
 - If moving the disc does not help, it's probably a film problem. Ask distributor for replacement reel.
- No cues should be placed within timecode.
- Enter "**Status**" screen to see how the unit is performing. See Section 8.2.
- Is **reader's green LED blinking**? It should be solid bright, very occasional blink is OK.
 - If only **one reel blinks**, ask distributor for replacement reel.
- Frequent TC blinking **on all reels** is usually a reader or tension problem. See "BLINKING TIMECODE READER LED" troubleshooting guide.
 - If the TC light on DTS-6AD or reader is blinking, gently squeeze the film between two fingers as it enters the reader and pull back. If the blinking stops and maintains a steady glow, this indicates more tension is needed. Tension is added by repositioning the auxiliary flanged roller on the reader so that it has maximum contact with the film. Or, add a cleaning roller to platter system.
 - Gently squeeze the film between two fingers as it exits the reader. If the blinking stops, check projector for worn gears or belts. An oscilloscope should be used to observe signal.
 - **Christie platters:** This platter has a spring in the center cluster (center roller) which should be in good condition, clean and well lubricated. *Do not remove it.* If removed, it will cause film bounce, which causes the DTS reader to not see good timecode.
 - Attach the **grounding jumper** on the reader's timecode cable to the projector. Easiest place to do that is to attach to the screw that secures the timecode cable to the reader head. The reader's housing must be electrically connected to the projector housing. Verify with an ohm meter.
 - If the reader's **green LED is very dim**, replace the reader.
- Are the **CD-ROM drives** and **discs** working properly?

◆ Unit defaults to wrong sound format.

- If at show end or after RESET, check MENU default programming. See Section 8.3.2.
- If during the show, check default functions of DTS-6AD.
 - Use the DTS Setup Disc. Insert the disc and let the first program play. The first program is LEFT channel. Once left channel pink noise plays, eject disc. The sound format should default to F2 A-Type. Insert disc and wait for LEFT channel to be announced, press F4 to advance to the next program. Next program is LEFT SURROUND. Once LEFT SURROUND pink noise plays, eject the disc. The sound format should default to F7 NONSYNC. Repeat for all remaining channels. A list for all default programs on the DTS Setup disc is given below. Be sure all work correctly.

<u>DTS Setup Disc</u> <u>Pink Noise Channel</u>	<u>DTS-6AD</u> <u>Default Format</u>
Left	A-Type
Surround	NONSYNC
Center	SR-Type
Right	Mono

- If defaults still wrong, during the show, try swapping out the D741 board.

11.3.4. CD-ROM DRIVE AND DISC ANOMALIES

- Look at the **lights on drives** themselves. They should blink sporadically when their disc is being read. If the light is on solid, this means the drive cannot read the disc. Try another disc, if the problem goes away, the original disc may be bad. Inspect the disc.
- If **disc needs cleaning**, wipe it with a clean dry cloth from the center straight out. Load disc back into unit and try again. If disc fails again, try playing it in another drive. If the problem goes away, then the drive is suspect. If the problem continues, then the disc should be replaced.
- If the **drive seems bad**, try cleaning it. Use a CD-ROM Laser Lens Cleaner (disc). This will clean off the laser's window. This disc can be purchased at any computer store. We recommend "KleenLens" made by AudioSource™. If cleaning the drive doesn't help, replace drive. See drawing on page 2-5 showing how to remove and set address jumpers for drives.
- If a **disc is stuck** in drive or if **discs are continuously ejected**, the drive must be replaced.
 - To release a **stuck disc**, get a paperclip and straighten it out. There should be a small hole on the drive, some near the tray. Push the paperclip into the hole, a release mechanism should be felt. Push on paperclip to release the tray.
- If **all drives seem dead**, verify their power input. They are powered by SRW115-3001 supply that delivers +5 and +12 volts DC.
- If **one drive seem dead**, verify its power input. Verify address jumpers correct. See "Replacing CD-ROM Drives".

Replacing Drives

When replacing drives on units below serial number 1075, be sure to keep their nylon washers. These washers stabilize the drives and MUST be used. To get to the bottom drive, all drives must be removed and separated.

DTS-6AD units after serial number 1075, have metalwork that allows drives to be removed individually.

See page 2-6 for drawing of drive removal and address jumper settings.

11.3.5. BYPASS ANOMALIES

◆ Stuck in BYPASS.

- Verify BYPASS toggle switch on D744 is set to the left (off).

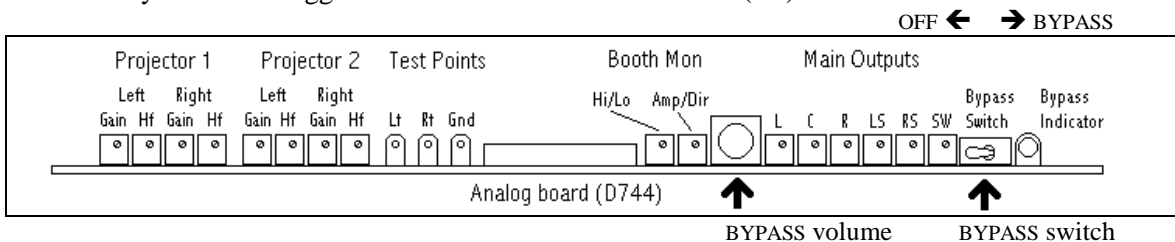

- Bypass Mode will automatically enable if a failure occurs in the D740 or D741 boards.
- Verify signal coming from stereo solar cells.

◆ No volume while in BYPASS.

- The BYPASS trimpot (D744 board) now adjusts volume. Front panel master fader is disabled while unit in Bypass Mode.
- Verify projector exciter lamp is on and that the lamp power supply is operating. Solar cell connections may be loose or damaged.
- Verify power amps are on.

11.3.6. MONITOR ANOMALIES

- Monitor volume is adjusted by the monitor volume control. Select channels to monitor by pressing appropriate buttons. Select INT SPK if using internal speaker. If an external speaker is used, it is normal for it to always be active – whether INT SPK is on or off.

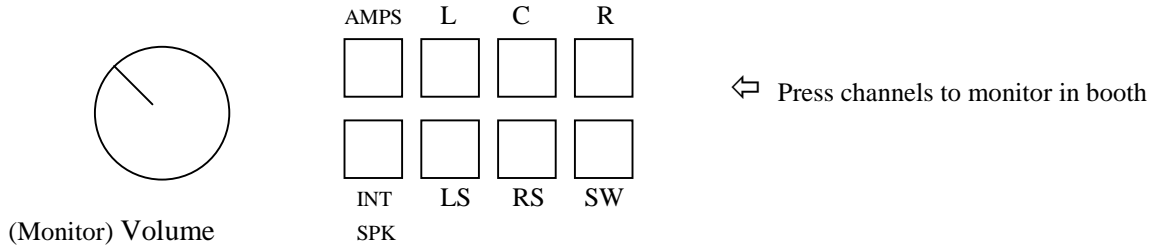

- Try swapping out the display panel.
- Try swapping out the D741 board.

11.3.7. NOISE, DISTORTION, AND OTHER SOUND ANOMOLIES.

- If apparent in DTS Digital format only, switch unit to analog and eject discs.
- Try swapping out the D744 board.
- If apparent in analog & DTS Digital, check amplifiers/speakers. During break, turn off all amps. Turn them on again one by one to localize the problem. If an amp hums, is noisy, or a speaker sounds distorted, replace it.

◆ Hum.

- If subwoofer a **Kintek KT-90**, try lifting the signal ground to the CP. Because this speaker is self-powered, grounding is critical. Be sure power cord has a ground prong that is connected to the AC ground. Never remove the ground prong.
- Keep signal cable runs as short as possible. Use only shielded cable and route away from power sources, florescent lights, and projector motor. Verify wiring of grounds.

◆ RF interference.

- Verify wiring of grounds. Do not tie circuit ground and chassis (earth) grounds together.
- Verify output cables are shielded and that one end of the shield is **earth** grounded. Never route DTS audio cables next to power lines, florescent light, or projector motors.

◆ Dual Projectors, change-over problems.

- Sound does not change with picture. If in analog, verify change-over relay is OK.
- If in DTS Digital, the DTS-6AD will automatically make a sound change-over when first frame of picture timecode is read on the upcoming projector. DTS digital sound changes independent of the projector's dower position. Adjustment of **roll down** on upcoming projector may be necessary to obtain a "seamless" change-over.
- If one **reader** is in sync but the other isn't, verify they are installed the same way on each projector.

◆ DTS-6AD resets after a change-over .

Projector motor probably effecting DTS control lines. Verify output cables are shielded and that one end of the shield is **earth** grounded. Never route DTS audio cables next to or with power lines or projector motors. Do not run them together through the same conduit. Separate conduit is preferred.

◆ Thumping noise heard in auditorium while playing in analog.

Sound head picking up DTS timecode track. Sound head needs lateral adjustment. Thread up buzz track film and make adjustments. A complete "A" chain alignment is recommended. See Section 6.

-continued-

11.3.7. NOISE, DISTORTION, AND OTHER SOUND ANOMOLIES (continued)

❖ Sound “WOWs”.

- Apparent in analog as well? If yes, check projector speed and platter/reel alignment/adjustments – including balance of intake vs. output.
- Apparent only while in DTS Digital format? Play film in analog until there is time to troubleshoot.
- Test the speed of the projector by using the DTS Projector Speed Test Disc. Follow directions included with disc.
- Is the timecode reader’s green LED blinking? If yes, see “BLINKING TIMECODE READER LED”, in this section.
- Test the projector’s speed by using the DTS Projector Speed Test Disc. Follow instructions included with disc.

❖ Missing channel(s) or channels don’t sound balanced.

- Are all power amps on? Are their volume controls turned up?
- Play film in analog format and if sound restored, play film in analog until time to troubleshoot.
- If sound not restored, switch unit to BYPASS and wait until there is time to troubleshoot.
- Use internal pink noise generator to verify output settings for all 6-track channels. Remember, use the internal pink noise generator to set levels. The DTS Setup Disc is used only to *verify* digital levels.
- Perform A-chain alignment (Section 6) for (projector) stereo optical output.
- Verify connections from DTS-6AD to amplifiers/solar cells.
- Verify amplifier/solar cell output.

❖ Channels are mixed together or coming out of the wrong speakers.

- If in 6-track only, use DTS Setup Disc to test 6-track outputs. Listen in theater to verify pink noise is coming out of the correct speakers. Levels are set with internal pink noise generator.
- If in analog only, A-chain may have become misaligned.
- Verify output at DTS-6AD connectors. If OK, check wiring – check for shorts. Verify ground connection is good and that the correct ground is being used
- If output not OK, try swapping out the D741 board. Try swapping out the D740 board

❖ Sound not in-sync with picture projected.

- If playing in DTS digital, switch the unit to analog. Take out the movie discs and wait for intermission. **Do not attempt to remedy sync problems while playing in DTS digital.**
- During intermission, check the delay (offset) setting. Verify film path is correct and the same used as when DTS sync delay was measured. Hopefully, a threading map was left for the projectionist. If sync must be re-measured and reset, see Sections 7.3 and 7.4.
- Thread the film **exactly** the same way as when calculating the offset. Make and post a threading map.
 - Make same size loops.
 - Thread though same rollers.
 - Thread though same reader(s).
- Once delay reset, load the movie discs and try them again for the next show. If sync still not correct, contact DTS Technical Support.
- Verify correct placement of timecode using “Track Specs” at the end of Section 7.

❖ Volume suddenly increases and decreases during movie.

- Sound format is probably changing.
- Check for steady illumination of timecode (TC) LED.
- Check that discs and CD-ROM drives are working OK.
 - Look at the lights on **drives** themselves. They should blink sporadically when their disc is being read. If the light is on solid, this means the drive cannot read the disc. Try another **disc**, if the problem goes away, the original disc may be bad. Inspect the disc. If the problem remains, the drive is probably bad.
- Enter “**Status**” screen to see how the unit is performing. See Section 8.2.

11.4. BINKING TIMECODE READER LED

The timecode reader LED should remain bright and not flash more than a few times a minute. Excessive flashing indicates a problem and should be fixed as soon as possible. The optics on the reader should be blown off with compressed air at least once a day, but **never adjust the lens**.

Excessive blinking can cause drop-outs (if the 4-second flywheel is exceeded). Drop-outs can produce wow, edits, and repeated sound track.

There are four things that can cause the reader LED to blink:

- 1) **Bad/poor timecode.** This is usually limited to a single reel or trailer, and is encountered infrequently. If seeing bad reels regularly, check for other problems.
- 2) **Film instability/speed.** This is caused by film bouncing through the reader or a projector that is running at the far end of the DTS player's speed range.
- 3) **Electrical noise/grounding problems.** One cause is the projector's chassis not being earth grounded.
- 4) **DTS equipment problem.** This is caused by either the reader or the player. If another reader can be borrowed from a working screen, try swapping.

Bad/Poor Timecode

See "DTS Encoded Film" specifications at the end of Section 7.

Film Instability/Speed

- Check the speed of the projector. It should run at 24 fps +/-5%.
- Make sure the reader's auxiliary roller (back with an adjustable arm) is installed and provides as much wrap as possible on the incoming silver roller. It should be pivoted towards the cable end of the reader and be back as far as possible.
- Watch the film run through the reader. If aligned properly, the film should contact each side of the roller evenly.
- Gently squeeze the edges of the film between two fingers as it enters the reader, pull back slightly and allow your fingers to act as shock absorbers. Repeat on the exit side of the reader. If the LED stabilizes, try to find the source of instability. The following are possible sources of instability:
 - Poor reader alignment
 - Too much tension
 - Bad rollers(s)
 - Bad platter center piece
 - Bad projector belt, gear, or sprocket
 - Bent reel
 - Too little tension
 - Reel clutch
 - Platter center piece spring removed (AW-3)

-continued-

11.4. BLINKING TIMECODE READER LED (continued)

Electrical noise/grounding problems

- Electrical noise on the timecode input(s) can confuse the timecode reader circuit. This causes the LED to blink and, in some cases, cause sound wow, edits, and dropouts. First, make sure the projector(s) and the DTS chassis are earth grounded.
- The current reader cables (from the DTS factory) have a shield wire shrink-wrapped to the cable's jacket, on the reader end. Cut the shrink-wrap away and connect the wire to one of the screws that hold the reader to its bracket. Check for any change in operation.
- If you have made your own cable or modified the factory cable in any way, be sure the shield is connected to the conductive connector shells **at both ends**.
- Do not run the timecode cable along power lines, over florescent light fixtures, or near motor controllers. Cable must be shielded.
- If the timecode reader-head board is Rev. F or lower, replace the reader with a newer revision board. The board revision can be viewed by tilting the reader and looking just below the 9-pin connector.

DTS equipment problem

- Borrow a known good reader from another screen. If this fixes the problem, replace the reader.
- Check the timecode cable. Verify continuity and physical integrity.
- Check firmware inside the player.

Checking timecode with an oscilloscope

- Connect option 1 Remove the timecode reader cable's connector shell from the reader end. Connect the scope probe to Pin 1 and the scope ground to Pin 6.
- Connect option 2 If using the "DTS timecode reader to oscilloscope adapter" (DTS P/N D929), simply disconnect the timecode cable from the reader head. Connect the adapter to the reader head (male DB9) and connect the timecode cable to the other end of the adapter (female DB9). Then, connect the BNC to the oscilloscope.

Set the scope to 0.5V/division, sweep at 0.5mS/division, and the trigger to internal.

Run a reel of time-coded film (BILL AND BUZZ reel preferred) and observe the timecode cells. The amplitude should be constant, and approximately 4 Volts Peak-to-Peak. The cells should be visible all the way to the right of the scope screen. The cross-points ("X"s) should be well defined (FIG. 1). Poorly defined cells are shown in FIG. 2. They are caused by film bounce and jitter through the projector or from the platter/reel.

FIG. 1 GOOD TIMECODE

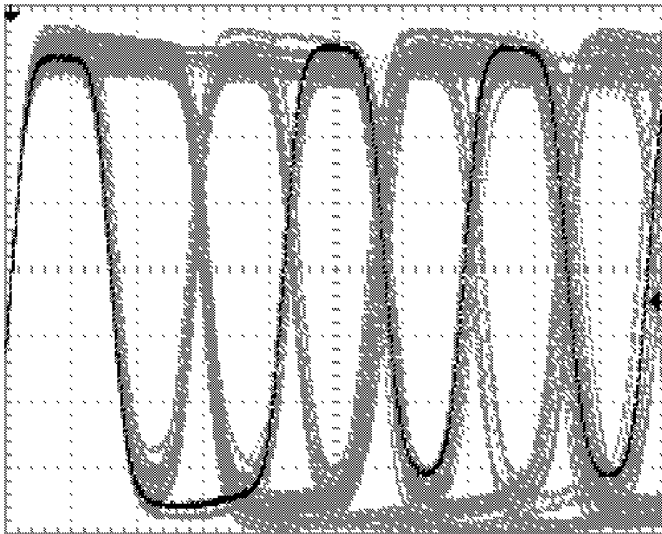

500mV/DIV .5mS/DIV

FIG. 2 POOR TIMECODE

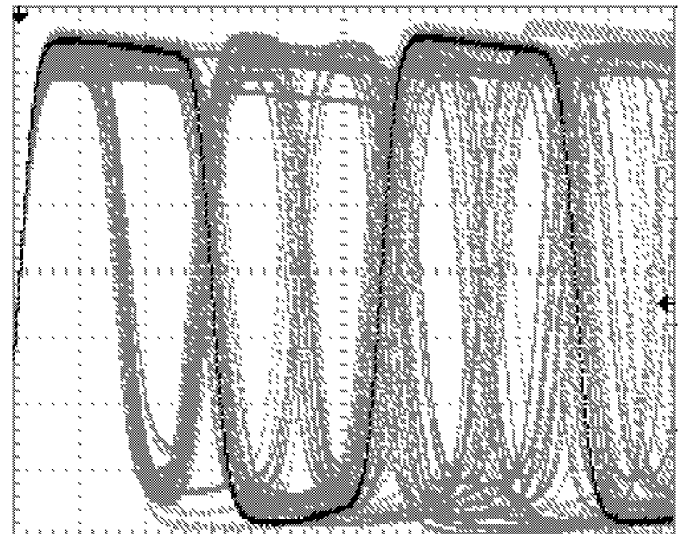

500mV/DIV .5mS/DIV

11.5. UPDATING DTS-6AD SOFTWARE

Software is updated by the use of a DTS-6AD System Disc that is available only from DTS.

If, after troubleshooting, a software update is recommended, DTS will send you a DTS-6AD “System Disc”. This disc will contain software files that must be uploaded into the DTS-6AD. The **upload should never be done during a show**, it should only be done during a break, or preferably, before any shows start or after all shows have ended.

PROCEDURE

1. Power on the DTS-6AD and load the “System Disc” into Drive A. Drives B & C should be empty.
2. Once the “System Disc” is loaded, power down the DTS-6AD.
3. Wait 3 seconds and power on the DTS-6AD. While unit is booting, press and hold down the FMT key.
4. When the screen displays: `Selftest . . OK` release the FMT key.
5. The DTS-6AD will now load the new system software into its non-volatile memory. It will take about 1 minute 40 seconds. The bottom of the screen will display `Please Wait . . .`
6. Press OK when the screen displays: `Press [OK] to continue.` This will run the new program version.
7. Check loaded software by removing the “System Disc”. Press RESET button (on D740, bottom board behind display). After unit boots, press MENU, then F7 VERSION. The screen should display the new software files (they will be noted on the disc). Only the files that have been updated will change version. The screen should look something like:

CPU VERSION	V1.03
DSP VERSION	V1.08
DSP FIRMWARE	V1.03

8. Press FMT to return to the normal operating screen. Load movie/trailer discs back into unit.

11.6. DTS TECHNICAL SUPPORT

TELEPHONE: (800) 959-4109 *or* (818) 706-3525 **FAX:** (818) 879-2746

DTS engineers are available to assist you. If an emergency occurs after business hours, please leave a message with the answering service. Your call will be returned as soon as possible.

INTERNET users may email DTS Technical Support at: cinematech@dtsonline.com

DTS Web Site <http://www.dtsonline.com>

NOTES

Thank you for choosing DTS !

SECTION 12

APPENDICIES

This chapter contains the following Appendices:

- Appendix A DTS-6AD Back Panel Connectors
- Appendix B D744 Analog (bypass) Board Jumper Settings
- Appendix C DTS-6AD System Replacement Parts List
- Appendix D Using the DTS Empirical Test Disc With the DTS-6AD
- Appendix E Marquee Order Form
- Appendix F RT-60 Test Section
- Appendix G Using the Upload / Download Software Program
- Appendix H Using the DTS-6AD with Extended Surround Equipment

NOTES

Thank you for choosing DTS !

APPENDIX A

DTS-6AD BACK PANEL CONNECTOR PIN-OUTS

<u>CONN.</u>	<u>FUNCTION</u>	<u>PAGE</u>
P1	MONITOR IN	A-2
P2	TO POWER AMPS	A-3
P3	MONITOR OUT	A-4
P4 & P5	PROJ 1 & PROJ 2 OPTICAL INPUTS	A-4
P6	EXTERNAL NOISE REDUCTION	A-5
P7A	AUX POWER	A-5
P8	6 TRACK ANALOG IN	A-6
P9A & P9B	NONSYNC LEFT & RIGHT IN	A-7
P10A & P10B	RS-422	A-8
P11A & P11B	AUTOMATION	A-8
P13	PROJ 1 TC	A-9
P14	PROJ 2 TC	A-9
P15 & P16	STATUS/CONTROL A & B	A-10
P17	RS-232	A-8
P23	HEARING IMPAIRED OUT	A-7
P25	L/R SPDIF OUT	A-9
P26	LS/RS SPDIF OUT	A-9
P27	C/SW SPDIF OUT	A-9
P28	REMOTE FADER	A-7

APPENDIX A

DTS-6AD AUDIO MONITOR INPUT FROM POWER AMPS (P1)

“MONITOR IN”

PIN NO.	DESCRIPTION	
1	LEFT LF IN +	
2	LEFT SURROUND LF IN +	
3	CENTER LF IN +	
4	RIGHT SURROUND LF IN +	
5	RIGHT LF IN +	
6	SUB WOOFER/ AUX LF IN +	
7	LEFT HF IN +	WIDE-BAND
8	LEFT SURROUND HF IN +	WIDE-BAND
9	CENTER HF IN +	WIDE-BAND
10	RIGHT SURROUND HF IN +	WIDE-BAND
11	RIGHT HF IN +	WIDE-BAND
12	SUB WOOFER/ AUX HF IN +	WIDE-BAND
13	ANALOG GROUND	
14	LEFT LF IN -	
15	LEFT SURROUND LF IN -	
16	CENTER LF IN -	
17	RIGHT SURROUND LF IN -	
18	RIGHT LF IN -	
19	SUB WOOFER/ AUX LF IN -	
20	LEFT HF IN -	WIDE-BAND
21	LEFT SURROUND HF IN -	WIDE-BAND
22	CENTER HF IN -	WIDE-BAND
23	RIGHT SURROUND HF IN -	WIDE-BAND
24	RIGHT HF IN -	WIDE-BAND
25	SUB WOOFER/ AUX HF IN -	WIDE-BAND

FEMALE 25 PIN D CONNECTOR (BACK PANEL)

When the speakers are not bi-amped, connect the amplifier outputs to HF (wideband) inputs only.

APPENDIX A

DTS-6AD AUDIO OUT (P2) “TO POWER AMPS”

PIN NO.	DESCRIPTION	
1	LEFT LF OUT +	
2	LEFT SURROUND LF OUT +	
3	CENTER LF OUT +	
4	RIGHT SURROUND LF OUT +	
5	RIGHT LF OUT +	
6	SUB WOOFER/ AUX LF OUT +	
7	LEFT HF OUT +	WIDE-BAND
8	LEFT SURROUND HF OUT +	WIDE-BAND
9	CENTER HF OUT +	WIDE-BAND
10	RIGHT SURROUND HF OUT +	WIDE-BAND
11	RIGHT HF OUT +	WIDE-BAND
12	SUB WOOFER/ AUX HF OUT +	WIDE-BAND
13	ANALOG GROUND	
14	LEFT LF OUT -	
15	LEFT SURROUND LF OUT -	
16	CENTER LF OUT -	
17	RIGHT SURROUND LF OUT -	
18	RIGHT LF OUT -	
19	SUB WOOFER/ AUX LF OUT -	
20	LEFT HF OUT -	WIDE-BAND
21	LEFT SURROUND HF OUT -	WIDE-BAND
22	CENTER HF OUT -	WIDE-BAND
23	RIGHT SURROUND HF OUT -	WIDE-BAND
24	RIGHT HF OUT -	WIDE-BAND
25	SUB WOOFER/ AUX HF OUT -	WIDE-BAND

FEMALE 25 PIN D CONNECTOR (BACK PANEL)

When the speakers are not bi-amped and internal crossovers are used in the DTS-6AD, verify that the crossover jumpers are set correctly. Avoid sending full-range, wideband audio through the HF drivers. See Appendix B "Jumper Settings for Wide-Band or Crossover Outputs"

APPENDIX A

DTS-6AD EXTERNAL SPEAKER OUT (P3)

“MONITOR OUT”

PIN NO.	DESCRIPTION
CENTER	AUDIO OUT
SHIELD	ANALOG GND.

FEMALE RCA-TYPE PHONO CONNECTOR (BACK PANEL)

DTS-6AD SOLAR CELL INPUTS (P4 & P5)

(P4) “PROJ 1 OPTICAL INPUT” & (P5) “PROJ 2 OPTICAL INPUT”

PIN NO.	DESCRIPTION
1	LEFT +
2	LEFT -
3	N.C.
4	RIGHT +
5	RIGHT -
6	LEFT ANALOG GND.
7	N.C.
8	N.C.
9	RIGHT ANALOG GND.

FEMALE 9 PIN D CONNECTOR (BACK PANEL)

The cable shield should be connected to Pins 6 and/or 9. Pins 2, 3, and 5 are internally tied together.

APPENDIX A

DTS-6AD EXTERNAL NOISE REDUCTION IN/OUT (P6)

PIN NO.	DESCRIPTION	
1	LEFT OUT+	(To N.R.)
2	RIGHT OUT +	(To N.R.)
3	LEFT IN +	(From N.R.)
4	RIGHT IN +	(From N.R.)
5	ANALOG GROUND	
6	LEFT OUT -	(To N.R.)
7	RIGHT OUT -	(To N.R.)
8	LEFT IN -	(From N.R.)
9	RIGHT IN -	(From N.R.)

FEMALE 9 PIN D CONNECTOR (BACK PANEL)

AUX POWER (P7A)

EXTERNAL SUPPLY INPUT, ± 12 to 15 Volts DC at 2 Amps

PIN NO.	DESCRIPTION	COLOR
1	+12 to 15 VDC	BLUE
2	ANALOG GND.	WHITE
3	-12 to 15 VDC	RED

MALE 3 PIN MOLEX CONNECTOR (BACK PANEL)

APPENDIX A

DTS-6AD EXTERNAL ANALOG AUDIO IN (P8)

“6 TRACK ANALOG IN”

PIN NO.	DESCRIPTION
1	LEFT IN -
2	RIGHT SURROUND IN +
3	LEFT SURROUND IN -
4	RIGHT SURROUND IN -
5	RIGHT IN -
6	N.C.
7	CENTER IN -
8	N.C.
9	N.C.
10	N.C.
11	SUBWOOFER IN -
12	N.C.
13	ANALOG GROUND
14	LEFT IN +
15	LEFT SURROUND IN +
16	N.C.
17	RIGHT IN +
18	N.C.
19	N.C.
20	CENTER IN +
21	N.C.
22	N.C.
23	N.C.
24	SUBWOOFER IN +
25	N.C.

FEMALE 25 PIN D CONNECTOR (BACK PANEL)

APPENDIX A

DTS-6AD NONSYNC INPUTS (P9A & B)

NONSYNC LEFT IN (P9A) and NONSYNC RIGHT IN (P9B)

PIN NO.	DESCRIPTION
CENTER	LEFT AUDIO IN
SHIELD	ANALOG GND.

FEMALE RCA-TYPE PHONO CONNECTOR (BACK PANEL)

DTS-6AD REMOTE FADER (P28)

PIN NO.	DESCRIPTION
1	CONTROL IN MUTE
2	FADER WIPER
3	CONTROL FADER IN
4	STATUS FADER OUT
5	+ 5 VDC
6	DIGITAL GROUND
7	DIGITAL GROUND
8	DIGITAL GROUND
9	STATUS OUT MUTE

FEMALE 9 PIN D CONNECTOR (BACK PANEL)

For connection details, see SDE238 in Section 10.

HEARING IMPAIRED OUT (P23)

PIN NO.	DESCRIPTION
CENTER	AUDIO OUT
SHIELD	ANALOG GND.

FEMALE RCA-TYPE PHONO CONNECTOR (BACK PANEL)

APPENDIX A

DTS-6AD RS-232 SERIAL COMMUNICATIONS (P17)

PIN NO.	DESCRIPTION
1	N.C.
2	RXD
3	TXD
4	N.C.
5	DIGITAL GROUND
6	N.C.
7	N.C.
8	N.C.
9	N.C.

MALE 9 PIN D CONNECTOR (BACK PANEL)

DTS-6AD RS-422 DCP I/O (P10A & B)

PIN NO.	DESCRIPTION
1	TXB -
2	TXB +
3	DIGITAL GND.
4	N.C.
5	RXB -
6	RXB +

FEMALE 8 PIN RJ45 CONNECTOR (BACK PANEL)

Future application

DTS-6AD LOCAL I/O (P11A & B)

“AUTOMATION”

PIN NO.	DESCRIPTION
1	TXC -
2	TXC +
3	DIGITAL GND.
4	+12VDC
5	RXC -
6	RXC +

FEMALE 8 PIN RJ45 CONNECTOR (BACK PANEL)

Future application

APPENDIX A

DTS-6AD TIMECODE INPUTS (P13 & P14)

(P13) "PROJ 1 TC" and (P14) "PROJ 2 TC"

PIN NO.	DESCRIPTION
1	TC IN FROM PROJECTOR
2	N.C.
3	N.C.
4	SMPTE TIMECODE OUT
5	+5 VDC (FROM DTS-6AD)
6	DIGITAL GROUND
7	DIGITAL GROUND
8	DIGITAL GROUND
9	"TC PRESENT" LED SIGNAL FROM DTS-6AD

FEMALE 9 PIN D CONNECTOR (BACK PANEL)

L/R SPDIF OUT (P25) < to left / right digital amps

LS/RS SPDIF OUT (P26) < to left surround / right surround digital amps

C/SW SPDIF OUT (P27) < to center / subwoofer digital amps

PIN NO.	DESCRIPTION
CENTER	SPDIF OUT
SHIELD	DIGITAL GND.

FEMALE RCA-TYPE PHONO CONNECTORS (BACK PANEL)

APPENDIX A

DTS-6AD STATUS / CONTROL A & B CONNECTORS (P15 & P16)

(P15) "STATUS/CONTROL A" & (P16) "STATUS/CONTROL B"

PIN NO.	DTS-6AD FUNCTION	FACTORY DEFAULT FORMAT SETTINGS	FRONT PANNEL BUTTON
1	CONTROL 0 IN	MONO	F1*
2	CONTROL 1 IN	A-TYPE	F2
3	CONTROL 2 IN	SR-TYPE	F3
4	CONTROL 3 IN	TRIM IN	
5	CONTROL 4 IN	EXTERNAL	F5
6	CONTROL 5 IN	DTS DIGITAL	F6
7	CONTROL 6 IN	NONSYNC	F7
8	CONTROL 7 IN	TRIM OUT	
9	CONTROL C/O IN		
10	CONTROL MUTE IN	MUTE	MUTE
11	N.C.		
12	DIGITAL GROUND		
13	+ 5 VDC		
14	STATUS 0 OUT	MONO	
15	STATUS 1 OUT	A-TYPE	
16	STATUS 2 OUT	SR	
17	STATUS 3 OUT	TRIM IN	
18	STATUS 4 OUT	EXTERNAL	
19	STATUS 5 OUT	DTS DIGITAL	
20	STATUS 6 OUT	NONSYNC	
21	STATUS 7 OUT		
22	STATUS 8 OUT		
23	STATUS MUTE OUT	MUTE	
24	CONTROL MTR IN	MOTOR START	
25	CONTROL C/O IN	LOW = PROJECTOR 2	

FEMALE 25 PIN D CONNECTOR (BACK PANEL)

***NOTE:** F1 sound format can be reassigned through programming MENU

APPENDIX B

D744 BYPASS BOARD JUMPER SETTINGS

<u>FUNCTION</u>	<u>PAGE</u>
MAIN AUDIO OUTPUTS: BALANCED OR UNBALANCED	B-2
WIDE-BAND OR CROSSOVER OUTPUTS	B-3
SCREEN CHANNEL TIME ALIGNMENT DELAY	B-4
SCREEN LOSS COMPENSATION EQ	B-5
EXTERNAL NOISE REDUCTION: BALANCED OR UNBALANCED	B-6
BOOTH MONITOR WAKE-UP STATE	B-7
RESISTOR VALUES FOR CROSSOVER RESISTOR PACKS	B-8

APPENDIX B

D744 JUMPER SETTINGS FOR BALANCED OR UNBALANCED MAIN AUDIO OUTPUTS

	LEFT CHANNEL	CENTER CHANNEL	RIGHT CHANNEL
OUTPUT	JUMPER NO.	JUMPER NO.	JUMPER NO.
HF +	W14	W34	W44
HF -	W12	W32	W42
LF +	W9	W29	W39
LF -	W6	W18	W36

	LEFT SURROUND	RIGHT SURROUND	SUBWOOFER
OUTPUT	JUMPER NO.	JUMPER NO.	JUMPER NO.
HF +	W3	W20	W24
HF -	W2	W19	W23
LF +	W5	W22	W26
LF -	W4	W21	W25

See Page 2-7 for a picture of D744 jumper locations and orientation.

- Each audio channel must have all it's four jumpers (HF+, HF-, LF+, LF-) at the same setting.
- For **balanced output** (factory default): Place the jumpers between the center pin and the left ("B") pin.
- For **unbalanced output**: Place the jumpers between the center pin and the right ("UB") pin.

APPENDIX B

D744 JUMPER SETTINGS FOR WIDEBAND OR CROSSOVER OUTPUTS

JUMPER NO.	CHANNEL
W17	LEFT
W35	CENTER
W45	RIGHT
W1	LEFT SURROUND
W15	RIGHT SURROUND
W16	SUBWOOFER

See Page 2-7 for a picture of D744 jumper locations and orientation.

- For **Crossover** (bi-amp) output: Place jumpers between the center pin and the left (“B”) pin.
- For **Wideband** output (factory default): Place jumpers between the center pin and the right (“W”) pin. The Wideband outputs appear on the **HIGH FREQUENCY** output pins of P2 for each channel.

CAUTION: When bi-amping speakers, verify jumper settings to ensure that full-range, wideband audio is not sent to the HF driver.

APPENDIX B

D744 JUMPER SETTINGS FOR SCREEN CHANNEL TIME ALIGNMENT DELAY SETTINGS

DELAY TIME	LEFT CHANNEL	CENTER CHANNEL	RIGHT CHANNEL
	JUMPER NO.	JUMPER NO.	JUMPER NO.
0.3 mSec	W11	W30	W41
0.4 mSec	W8	W28	W38
0.5 mSec	W10	W31	W40
0.6 mSec	W7	W27	W37

See Page 2-7 for a picture of D744 jumper locations and orientation.

- To **reduce the delay** to the low frequency output: Place jumpers between the center pin and left (“O”) pin.
- To **add delay** to the low frequency output: Place jumpers between the center pin and right (“I”) pin.
- **Factory default is with all jumpers set to “out” for no delay.**
- The **total delay time** is calculated by adding the delay time for each “in” jumper. The chart below illustrates all possible delay times and the jumper settings to achieve each total delay.

JUMPER DELAY →	0.3 mSec	0.4 mSec	0.5 mSec	0.6 mSec
TOTAL DELAY IN mSec ↓				
0.0	OUT	OUT	OUT	OUT
0.3	IN	OUT	OUT	OUT
0.4	OUT	IN	OUT	OUT
0.5	OUT	OUT	IN	OUT
0.6	OUT	OUT	OUT	IN
0.7	IN	IN	OUT	OUT
0.8	IN	OUT	IN	OUT
0.9	OUT	IN	IN	OUT
0.9	IN	OUT	OUT	IN
1.0	OUT	IN	OUT	IN
1.1	OUT	OUT	IN	IN
1.2	IN	IN	IN	OUT
1.3	IN	IN	OUT	IN
1.4	IN	OUT	IN	IN
1.5	OUT	IN	IN	IN
1.8	IN	IN	IN	IN

See Page 2-7 for a picture of D744 jumper locations and orientation.

APPENDIX B

D744 JUMPER SETTINGS FOR SCREEN LOSS COMPENSATION EQ

LEFT CHANNEL	CENTER CHANNEL	RIGHT CHANNEL
JUMPER NO.	JUMPER NO.	JUMPER NO.
W13	W33	W43

See Page 2-7 for a picture of D744 jumper locations and orientation.

- To **disable** the screen loss equalization (factory default): Place the jumpers between the center pin and the left (“O”) pin.
- To **activate** the screen loss equalization: Place the jumpers between the center pin and the right (“I”) pin.

APPENDIX B

D744 JUMPER SETTINGS FOR EXTERNAL NOISE REDUCTION BALANCED OR UNBALANCED INPUT AND OUTPUT

	LEFT CHANNEL	RIGHT CHANNEL
OUTPUT TO EXT. N.R.	JUMPER NO.	JUMPER NO.
+	W51	W56
-	W48	W53
INPUT FROM EXT. N.R.	JUMPER NO.	JUMPER NO.
+	W49	W57
-	W50	W54

See Page 2-7 for a picture of D744 jumper locations and orientation.

- For each channel, set “+” and “-” jumpers to the same setting.
- For **Balanced** operation (output or input) (factory default): Place the jumpers between the center pin and the left (“B”) pin.
- For **Unbalanced** operation (output or input): Place the jumpers between the center pin and the right (“UB”) pin.

APPENDIX B

D744 DIP SWITCH SETTINGS FOR BOOTH MONITOR WAKE-UP STATE

SWITCH NO.	SWITCH CLOSED	SWITCH "OPEN"	JUMPER NO.
Units after S/N 1075	JUMPER "IN"	JUMPER "OUT"	S/N 1075 & earlier
S2 - 1	Internal Speaker ON	Internal Speaker OFF	W55-1
S2 - 2	Amplifier Returns	Processor Output	W55-2
S2 - 3	LS & RS ON	LS & RS OFF	W55-3
S2 - 4	Center ON	Center OFF	W55-4
S2 - 5	Left & Right ON	Left & Right OFF	W55-5

See Page 2-7 for a picture of D744 jumper locations and orientation.

- To wake-up with **internal speaker on**: Set DIP switch S2-1 closed (factory default). Units with S#1075 and earlier, place jumper W55-1 between the center and top ("I") pins.
- To wake-up with the **internal speaker off**: Set DIP switch S2-1 open. Units with S#1075 and earlier, place jumper W55-1 between the center and bottom ("O") pins.
- To **monitor the output of the power amplifiers** connected to (P1) "MONITOR IN": Set DIP switch S2-2 to closed (factory default). Units with S#1075 and earlier, place jumper W55-2 between the center and top ("I") pins.
- To **monitor the output of the DTS-6AD**: Set DIP switch S2-2 open. Units with S#1075 and earlier, place jumper W55-2 between the center and bottom ("O") pins.
- To select which **audio channels will be monitored** upon wake-up, using the chart above, set DIP switches S2-3, S2-4, and S2-5 as needed:
 - **Closed** = in order to monitor the selected channel
 - **Open** = in order to not monitor the selected channel

Factory Defaults: S2-3 open, S2-4 closed, S2-5 closed

Units with S#1075 and earlier, place jumpers W55-3, W55-4 and W55-5 between the center and either the top ("I") pin or the bottom ("O") pins for each of the channels listed in the table above.

Factory Defaults: W55-3 out, W55-4 in, W-55-5 in.

- All the above switches (jumpers) select the format of the booth monitor when the DTS-6AD is first powered. After the unit is powered, any monitoring choice can be changed by pushing the corresponding front panel button.

APPENDIX B

D744 RESISTOR VALUES FOR CROSSOVER RESISTOR PACKS

Part No. 9030-D755-xx (surface mount version)

Part No. 9020-D755-xx (component carrier version)

“xx” = 01, 02, etc., depending on frequency (see table below)

RESISTOR		DTS PART NO. AND CROSSOVER FREQUENCY						
PACK		D755-01	D755-02	D755-03	D755-04	D755-05	D755-06	D755-07
		500 Hz	800 Hz	1200 Hz	630 Hz	1000 Hz	297 Hz	330 Hz
1	RA	10.0 K	6.49 K	4.22 K	7.87 K	4.99 K	16.9 K	15.0 K
2	RB	20.0 K	13.0 K	8.45 K	15.8 K	10.0 K	34.0 K	30.1 K
3	RA	10.0 K	6.49 K	4.22 K	7.87 K	4.99 K	16.9 K	15.0 K
4	RA	10.0 K	6.49 K	4.22 K	7.87 K	4.99 K	16.9 K	15.0 K
5	RA	10.0 K	6.49 K	4.22 K	7.87 K	4.99 K	16.9 K	15.0 K
6	RC	10.0 K	6.49 K	4.22 K	7.87 K	4.99 K	16.9 K	15.0 K
7	RB	20.0 K	13.0 K	8.45 K	15.8 K	10.0 K	34.0 K	30.1 K
8	RC	10.0 K	6.49 K	4.22 K	7.87 K	4.99 K	16.9 K	15.0 K

- 16 Pin Component Carrier Part No. 2020-0007-00. All resistors are 1%, ¼ Watt.
- Surface Mount version, resistors are 1%, 1/10 Watt
- Crossover resistor values for RA, RB, and RC are determined by the following formula:

$$RA = 500 / F_n \times 10,000$$

F_n is the new frequency in Hertz
 RA is the new value for RA and RC

$$RB = RA \times 2$$

APPENDIX C DTS-6AD System Replacement Parts List

DTS-6AD Internal Parts

9030-D740-00	CPU board assembly
9030-D741-00	DSP board assembly
9030-D744-00	Analog board assembly
9020-E225-00	Display assembly (includes panel, fader, format switches, monitor speaker & switches)
5102-0008-00	CD-ROM Drive, TEAC 32x
2806-0002-00	Fan, card cage
2806-0003-00	Fan, back panel
1902-0001-00	Power switch
2013-0002-00	Universal AC input module
2201-SW0D-05	± 12 VDC and +5 VDC supply module
2201-150D-02	± 15 VDC supply module

Installation Accessories

2007-0009-05	9-pin male D-connector w/solder cups	
2022-0001-00	9-pin D-connector back shell	
2007-0025-10	25-pin male D-connector w/solder cups	
2022-0003-01	25-pin D-connector back shell	
9003-E100-00	Standard screw kit for TCRH brackets	
2501-0001-00	Power cord, straight, detachable, standard	<i>bare-ended available, call DTS</i>
2501-0002-00	Power cord, right angle, detachable	

Timecode Cables

D435-01	30 ft. Timecode cable (standard)	<i>single-ended available, call DTS</i>
D435-02	40 ft. Timecode cable	
D435-05	45 ft. Timecode cable	
D435-06	60 ft. Timecode cable	

DTS Timecode Reader Heads and Auxiliary Rollers

D600-00	DTS 35mm reader head (auxiliary roller attached)
E108	Auxiliary roller assembly kit, 35mm
D600-02	DTS 70mm reader head (auxiliary roller attached)
E163	Auxiliary roller assembly kit, 70mm

Mounting brackets for TCRH (hardware included), permanent 35mm or 70mm

D614	Standard bracket (for Century, Simplex, Ballantyne projectors)
D616	Phillips AA bracket (for Norelco projector)
D617	“L” bracket (for Kinoton projector)
D622	Front mount bracket (use with Dolby SR-D™ or Sony SDDS™ readers)
5006-0001-00	Cinemeccanica bracket (use with D614 standard bracket)
E102	70mm spacer kit (used to fit a 35mm reader in a 70mm space)

Mounting brackets for TCRH (hardware included), switchable 35mm / 70mm

D615	Universal bracket
D625	35mm/70mm standard bracket used with breakaway plates
D628	Adapter panel for D617 “L” bracket (so breakaway plates can be used)
D626	Breakaway (“spacing block”) plates for 35mm DTS reader head
D627	Breakaway (“spacing block”) plates for 70mm DTS reader head

Technician supplies and film:

E107	DTS Technician Kit (includes demo disc & 35mm film, setup & empirical test discs)
6060-0006-00	Empirical Test Disc, dated June 7 '97
6060-0005-0D	6-Track Setup Disc Rev. DS1
6060-0003-00	Buzz and Bill Show Disc (used w/DTS Demo film), dated Feb 1 '99
6800-0001-00	DTS Demo Film (used w/Buzz and Bill Show disc), 35mm (delay measure included)
6800-0002-02	DTS 70mm (measuring delay) offset film

USING THE DTS EMPIRICAL TEST DISC WITH THE DTS-6AD

CPU version 1.03 must be installed in the DTS-6AD. Load the Empirical Test disc into the DTS-6AD. No other discs should be in the unit. Once loaded, the screen will display that the “Empirical Test Section” is playing. The display will also show which reel (test) is playing. To perform a specific test, press F4 NEXT key until the desired test (reel) number is seen on-screen. ***CAUTION:** Tests in bold contain signals that may cause serious damage to sound systems that are not properly designed to reproduce the extended dynamic range of a digitally-based sound storage system.

<u>Test#</u>	<u>Description</u>
1	Empirical test section announcement
*2	Power handling test
3	Left level, set channel ID, pink noise @ 0dB alternating with low level multi-tone
4	Center level set
5	Right level set
6	Right surround level set
7	Left surround level set
8	Male voice for speaker comparison
9	Female voice for speaker comparison
10	Dialog, front speaker balance
11	Music for speaker comparison
12	Pink noise, surround speaker balance
13	Music, front speaker balance
14	Digital silence
15	Left channel ID, -10dB sweep, 0dB sweep
16	Left surround channel ID, -10dB sweep, 0dB sweep
17	Center channel ID, -10dB sweep, 0dB sweep
18	Right surround channel ID, -10dB sweep, 0dB sweep
19	Right channel ID, -10dB sweep, 0dB sweep
20	Room acoustics test: left surround, right surround, center
21	Left level sweep 400 Hz, -5dB to +5dB
22	Left surround sweep 400 Hz, -5dB to +5dB
23	Center level sweep 400 Hz, -5dB to +5dB
24	Right surround sweep 400 Hz, -5dB to +5dB
25	Right level sweep 400 Hz, -10dB to +20dB
26	Left level sweep 400 Hz, -10dB to +20dB
27	Left surround level sweep 400 Hz, -10dB to +20dB
28	Center level sweep 400 Hz, -10dB to +20dB
29	Right surround level sweep 400 Hz, -10dB to +20dB
30	Right level sweep 400 Hz, -10dB to +20dB
*31	Left explosion @ +10dB, +20dB
*32	Left surround explosion @ +10dB, +20dB
*33	Center explosion @ +10dB, +20dB
*34	Right surround explosion @ +10dB, +20dB
*35	Right explosion @ +10dB, +20dB
36	1kHz @ reference level, all channels (250mV RMS)
37	Left pink noise @ reference level (85dB SPL)
38	Left surround pink noise @ reference level (82 dB SPL)
39	Center pink noise @ reference level (85dB SPL)
40	Right surround pink noise @ reference level (82dB SPL)
41	Right pink noise @ reference level (85dB SPL)
42	Sub bass pink noise @ reference level (88dB SPL)
43	Left 1/3 octave pink sweep 25 Hz - 2 KHz, 1 second pause, sweep 2 KHz - 20 KHz
44	Left surround 1/3 octave pink sweep 125 Hz - 2 KHz, 1 second pause, sweep 2 KHz - 20 KHz
45	Center 1/3 octave pink sweep 25 Hz - 2 KHz, 1 second pause, sweep 2 KHz - 20 KHz
46	Right surround 1/3 octave pink sweep 125 Hz - 2 KHz, 1 second pause, sweep 2 KHz - 20 KHz
47	Right 1/3 octave pink sweep 25 Hz - 2 KHz, 1 second pause, sweep 2 KHz - 20 KHz
48	Sub Bass sweep 20 Hz - 80 Hz
49	5 channel pop test, channel number ID by number of pops
50	4 seconds pink noise: left, center, right, left surround, right surround

Feb00

DTS MARQUEE SIGN ORDER FORM

For every DTS unit installed in a theater, we will provide one-sheet posters, 4" mini-marquee, 8", 10", or 12" marquee signs at no charge. Please fill out the following information and they will be shipped within 2 to 3 weeks upon receipt of this completed order form. Marquees and posters can be sent directly to the theater or dealer for distribution. If the marquees are directly sent to the dealer, the name(s) and location(s) of the theater(s) is needed for our records.

January 1999

Dealer: _____

Theater: _____

Address: _____

Address: _____

Contact: _____

Contact: _____

Phone: _____

Phone: _____

FOR DTS-EQUIPPED THEATERS

4" mini marquee Qty. _____

8" panel Qty. _____

10" panel Qty. _____

12" panel Qty. _____

One sheets Qty. _____

Please return this form to:

Natasha Norris
Digital Theater Systems
5171 Clareton Drive
Agoura Hills, CA 91301 USA
Telephone: (818) 706-3525 or (800) 959-4109
Fax: (818) 879-2746

APPENDIX F RT-60 Test Section

Description

“RT” is an abbreviation for Reverberation Time. This is the time in seconds for a sound to decay to inaudibility after the source stops. This time is measured in seconds for the sound level at a specific frequency to decrease 60dB in level after the sound source stops.

Tools required: R2 unit (or similar RTS device), microphone multiplexer and calibrated microphones, and a remote control device (see diagram below).

- Connect the remote control device to the DTS-6AD P15 or P16 “Status/Control” connector (either one) on the rear panel.
- To begin, press MENU → SYSTEM SETUP → AUDIO → RT-60. The screen below should appear:

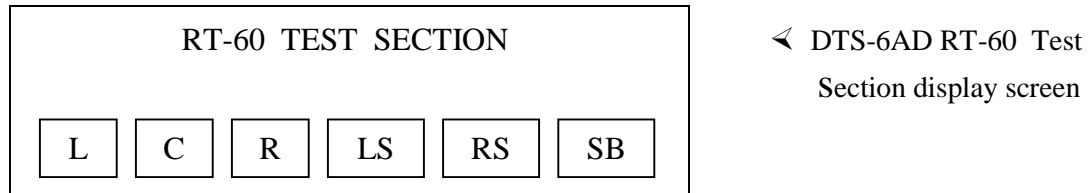

- The Remote Control device is used to enable pink noise on each individual or on all channels. As channels are selected, the corresponding channel will highlight on the screen.
- The remote sends control pulses to the DTS-6AD STATUS/CONTROL connector via the rear panel P15/16 STATUS/CONTROL connector. When in the RT-60 Test Section screen, the STATUS/CONTROL connections function as shown below. When not in the RT-60 Test Section screen, the STATUS/CONTROL connections function as normal.

P15/16 PIN# (DB-25)	DTS-6AD Function	External Button (pulsed contacts)	Factory Default Format Settings
1	Control 0 IN	1 - Left	MONO
2	Control 1 IN	2 - Center	A-TYPE
3	Control 2 IN	3 - Right	SR-TYPE
4	Control 3 IN	4 – Left Surround	TRIM IN
5	Control 4 IN	5 – Right Surround	EXTERNAL
6	Control 5 IN	6 - Subwoofer	DTS DIGITAL
7	Control 6 IN	7 - All Channels	NONSYNC
12	Ground		

- A simple RT-60 interface can be made with a BNC wired to Pin 7 and 12 of a DB-25 connector.

APPENDIX G USING THE DTS-6AD UPLOAD/DOWNLOAD PROGRAM

DTS-6AD Download/Upload Program

This program will upload and/or download complete software configuration to and from the DTS-6AD cinema processor using a laptop PC with Windows™ 95 (or after) The program may be downloaded free of charge from the DTS web site or may be purchased from DTS, kit number E250. This kit consists of the program on a floppy disc and a null modem cable.

The program organizes each DTS-6AD unit into a field hierarchy of Circuit name (or theater chain name), Theater name (the name of the theater in the circuit), and Screen (screen number). These fields must be filled in by the user. For each screen defined, the program will keep the configuration information that was downloaded from the DTS-6AD unit. It also allows the user to enter installation notes.

This program should be used to save all setup information on computer after installing and setting up a DTS-6AD in a theater. Whenever necessary, the configuration information and setup notes may be viewed offsite (from a computer). The same configuration information can be uploaded back to a DTS-6AD if replacement is needed.

The following configuration items are uploaded or downloaded from the DTS-6AD:

- Timecode reader offset delay setting.
- Surround delay setting.
- F1 key assignment option.
- Option to disable the matrix decoder.
- Default format.
- NONSYNC format mode.
- System password setting.
- NONSYNC trim.
- Automation trim values for Mono, A, SR, Digital, and External formats.
- Current audio setup information (Level, Bass, Treble, and EQ) for each channel.
- Alternate audio files Setup 1 and Setup 2.

Cable

Use a serial null modem cable (pin-out below) to connect the DTS-6AD (RS-232 connector) to a laptop PC. See below for connector pin-out:

DTS-6AD Side	PC Side
(DB-9 Female)	(DB-9 Female)
Pin 2 (Rx) -----	Pin 3 (Tx)
Pin 3 (Tx) -----	Pin 2 (Rx)
Pin 5 (Gnd) -----	Pin 5 (Gnd)

Installation & Setup

1. The laptop PC must have Windows™ 95 (or after) installed. A null mode cable must be used.
2. Create a new subdirectory on the computer hard drive for the DTS-6AD program.
3. Copy the program file 6AD.EXE and the help file HELP.TXT onto the new subdirectory.
4. Run the 6AD.EXE program.

RUNNING THE DTS-6AD DOWNLOAD/UPLOAD PROGRAM

Uploading from DTS-6AD to a PC

1. The serial communications port (COM1-COM4) must be selected. Most laptop PCs have only one port, so in this case, use COM1
2. Select “Add Circuit”. Enter the name of the theater chain. Example: EDWARD
3. Select “Add Theater”. Enter the name of the theater. Example: Camarillo16
4. Select “Add Screen”. Enter the screen name or number. Example: House1
5. Select “Load Settings From DTS-6AD”. All settings in the DTS-6AD will now load into the laptop PC. Once the downloading is completed, the PC screen will display “success”.
6. Select “View Configuration” to see what has been downloaded.
7. To add notes to what has been downloaded, select “Edit Notes”. Once the Notes screen appears, the circuit name, theater name, and screen will appear at the top left corner. The user may now type in notes. Once notes are completed, save them (go to file, save).

Sending Settings to DTS-6AD from a PC

1. Select “Send Settings to DTS-6AD”. A warning screen will appear “you are about to change settings on the DTS-6AD”. Select OK to continue. The upload will proceed.
2. Verify settings were uploaded by entering the DTS-6AD on-screen MENU. All configurations (noted on the first page) should be loaded into the DTS-6AD.