

DELPHI



SKYFi2™ Installation Guide

Home and Vehicle Kits

Contents:

SKYFi2 Vehicle Adaptor Kit Setup	2
SKYFi2 Installation	6
XM Antenna Setup	11
SKYFi2 Home Adaptor Kit Setup	15
Warranty	18



Warning: This manual and the *SKYFi2 Satellite Radio Receiver User Guide* contain important safety and operating information. Please read and follow the instructions in these manuals. Failure to do so could result in personal injury, death, and/or damage to your SKYFi2 Receiver, accessories, and/or to your vehicle or other property.



SATELLITE
RADIO

This device complies with Part 15 of the FCC rules. Operation is subject to the following two conditions:

1. This device may not cause harmful interference, and
2. This device must accept any interference received, including interference that may cause undesired operation.

The Delphi XM® SKYFi2™ Satellite Radio Receiver incorporates an FM transmitter and is therefore classified as an intentional transmitter. Changes or modifications to the unit not expressly approved by Delphi can void your authority to operate this equipment.

Important: The FCC and FAA have not certified the Delphi XM SKYFi2 Satellite Radio Receiver for use in any aircraft (neither portable nor permanent installation). Therefore, Delphi cannot support this type of application or installation.

SKYFi2 Vehicle Adaptor Kit (SA10102) Setup

Your Delphi XM SKYFi2 Vehicle Adaptor Kit contains the following components:

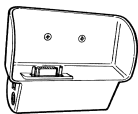

SKYFi2 Cradle

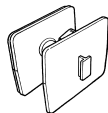

Vehicle swivel mount



Vent mount



XM Vehicle Antenna

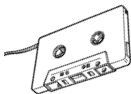

Cassette audio adaptor

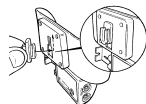

Nokia®-style button mount converter

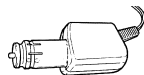

12V power adaptor

Your kit also includes:

- Extra adhesive pad
- Surface preparation cleaning kit
- Alcohol prep pad
- Cable wrap
- Adhesive-backed Velcro® pads

Figure 1. SKYFi2 Vehicle Adaptor Kit components.

Hooking up Your SKYFi2 Receiver Cradle

Caution: Connect only appropriate input devices to the SKYFi2 Vehicle Adaptor Kit. Connecting any incorrect input devices may damage the system and/or the external electronic device. It is recommended that you use only the 12V to 6V conversion power adaptor that came with your SKYFi2 Vehicle Adaptor Kit.

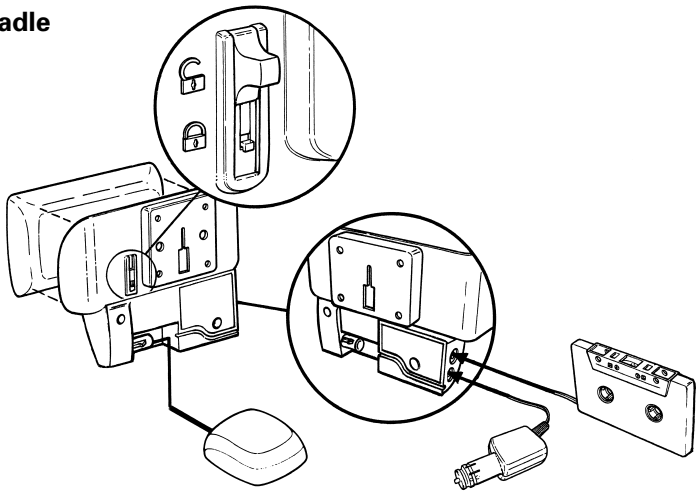

Figure 2. Connect accessories to your SKYFi2 Cradle as shown.

Cassette Adaptor

For vehicles with a built-in cassette player. **Due to its superior audio quality, this configuration is recommended over the wired or wireless FM modulator configurations if a cassette slot is available in the vehicle.**

Direct Connect

The Delphi FM Direct Adaptor (SA10112) (sold separately) can provide audio input through the vehicle's antenna lead. (Some vehicles may require special antenna lead adaptors.)

Wireless FM Modulator

For the ultimate ease of installation, SKYFi2 has a built-in wireless FM modulator that allows you to hear XM programming on any nearby FM radio. This FM modulator is turned on whenever the cassette adaptor or any other audio cable is unplugged from the SKYFi2 Cradle. See the *SKYFi2 Satellite Radio Receiver User Guide* for more details.

SKYFi2 Installation

Because every vehicle is different, these instructions are provided as a general guideline only. If you need help, consult a professional installer.

1. Decide which method (cassette adaptor, wireless FM modulator, or direct connect) is most appropriate for your vehicle and where you live.
2. Verify the system is working by completing a test. Before installing the system, connect the XM Antenna, 12V power adaptor, and audio connector or cassette adaptor (if used) to the SKYFi2 Vehicle Adaptor cradle with the SKYFi2 Receiver

inserted. Plug the 12V power adaptor into the cigarette lighter and place the XM Antenna on the roof of your vehicle. Make sure you are outdoors and not surrounded by tall buildings or trees. Turn on both your vehicle's radio and SKYFi2 Receiver. Tune the SKYFi2 Receiver to XM channel 1. You should be able to hear the XM Preview channel. If not, check all connections.

Note: If using the wireless FM modulator or the Delphi FM Direct Adaptor, set the SKYFi2 Receiver and the FM radio to the same frequency. See the *SKYFi2 User Guide* section on "Listening to XM Using Any FM Radio."



Warning: Do not install the mount where it or SKYFi2 could block your vision or usage of controls, or interfere with any safety devices such as airbags. Failure to correctly place SKYFi2 could result in injury to you or others if the unit becomes detached during an accident and/or obstructs the deployment of an airbag.

3. Turn off the radio and SKYFi2 Receiver. Disconnect all cables.
4. Find a place where you can mount your SKYFi2 Vehicle Adaptor where it is most convenient for you to use. It should be mounted to a hard, flat surface if possible or to a horizontal in-dash air vent. Be certain the air vent is rigid enough to hold the weight of both the SKYFi2 Receiver and the SKYFi2 Vehicle Adaptor Kit.
5. The SKYFi2 Vehicle Adaptor Kit has three mounting options: flat mount, vent mount, or swivel mount.
 - a. *Flat mount:* Use the included Velcro pads or extra adhesive pad, attaching them to the back of the SKYFi2 vehicle cradle and then to a flat surface in your vehicle. Do not install the mount on a leather surface.
 - b. *Vent mount:* Assemble the mount (if not assembled) by inserting the two clips into the main piece. Clip the assembly onto the vent, and then position the pivoting kickstand at the bottom. The orientation of the clips must match each other and may need to be rotated in one of two possible orientations depending on the design of the air vent being used. Be careful when installing and removing the vent mount clips to prevent damaging the vent fins.

- c. *Swivel mount:* This mount allows you to adjust the angle of your SKYFi2 Vehicle Adaptor after it is installed. This mount uses a strong adhesive that is not easily repositioned when installed, so use care when choosing the location of and placing the mount. Do not install this mount on a leather surface. Install the mount only if the temperature is at least 60°F.
- Clean the mounting surface with the enclosed surface preparation cleaning kit. Wipe the towelette in one direction only. Do not wipe the surface in a circular

motion or back and forth. Dry the area with a clean, dry cloth. Repeat the cleaning process. Allow to air dry thoroughly.

- Clean the same surface with the enclosed alcohol prep pad. Wipe in one direction only. Dry the area with a clean, dry cloth. Allow to air dry thoroughly.
- Warm the vehicle mount adhesive pad by using a hair dryer or by placing the vehicle mount on top of the vehicle's defrost outlet for several minutes with the heater on. Remove the liner from the

adhesive pad and adhere to the vehicle's surface. Make sure you accurately place the pad on the first try since in many cases it will bond almost immediately. For best results, do not touch or apply pressure to the vehicle mount for 72 hours.

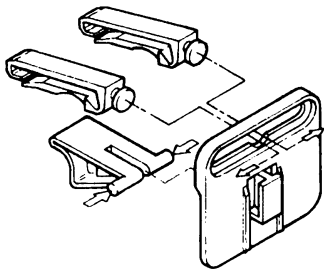

Figure 3. Vent mount.

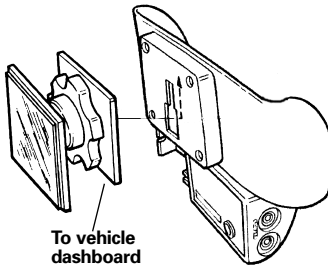

Figure 4. Attach vehicle mount to back of SKYFi2 as shown.

6. Clip the SKYFi2 vehicle cradle onto the vent or swivel mount (figures 3 and 4).
7. Reassemble the system as in step 2.
8. Attach the antenna as explained on page 11 and route the antenna cable as described on page 13.

Removing swivel mount from your dashboard

You can remove the swivel mount from your dashboard by following these steps:

1. Lift one edge of the adhesive pad gently with fingers or the rounded edge of a spoon. Once enough of the edge is loosened to grip with your fingers, pull the pad gently from the mounting surface at a 90-degree angle. Do not use sharp tools that could damage the vehicle's interior.
2. If the pad fails to loosen, warm it with a hair dryer for 2 to 3 minutes to soften the adhesive. Be careful not to apply too much heat, which could damage the mounting surface. Repeat step 1.
3. If any adhesive remains on the dashboard surface, the adhesive can easily be removed by rubbing your thumb or finger across it.
4. As necessary, use a mild household cleaner to clean the dashboard surface.

Caution: Never use a commercial heat gun or a paint-stripping gun. This can damage the unit or your vehicle.

XM Antenna Setup

For best reception, follow these recommendations:

- Mount the XM Antenna on the metal surface of the vehicle roof in the center of an area with at least 12" x 12" of surface area and a minimum of 6" from a window or sunroof. Figure 5 shows three typical mounting locations. Due to the small size of this antenna, there are many possible locations for installation depending on the vehicle. Improper positioning of the antenna could cause brief interruptions in the signal reception.

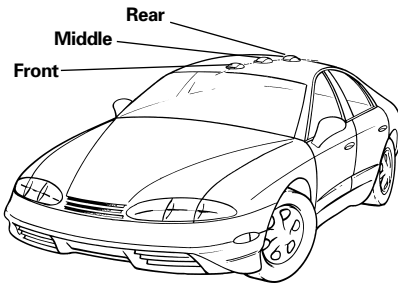

Figure 5. The design flexibility of your XM Antenna allows mounting on many types of vehicles. Trunk mounting of the antenna is an alternative only for hard- or soft-top convertibles with nonmetallic roof-tops. All other vehicles should have roof mounting.

Important: Do not install antenna inside the vehicle passenger compartment. An antenna mounted on the dashboard or on the rear window deck area of the vehicle will likely experience signal interruption issues and must be avoided. Mounting the antenna on a nonmetallic surface will also result in severe degradation in reception.

Warning: Failure to properly install the antenna may result in injury to you or others if it becomes detached during an accident.

A suitable compromise between installation location and reception quality must be assumed by the user.

- If the vehicle has roof racks or skid ribs, you may mount the antenna off-center.
- If the vehicle is a hard- or soft-top convertible, then the antenna can be mounted on the metal trunk lid at least 4" from the rear window. Ensure that the antenna does not interfere with the opening or closing of the convertible top and that the cable is free to move and not prone to wear. Where exposed to wind, it is best to route the cable parallel to the airflow.

- If you use the wireless FM modulator, place the antenna as close to the vehicle's FM antenna as possible. Note that the FM antenna may be embedded in the windshield or rear window.

If an appropriate antenna mounting location cannot be identified, contact your local retailer installation department for additional guidance.

Routing the Cable

Figure 6 illustrates a typical method of routing the antenna cable.

- Avoid kinking, crimping, twisting, or chafing the cable. If the cable comes into contact with a rough metal opening, use a rubber grommet to prevent damage.
- For antennas mounted at the front or middle of the roof, route the cable along the door jamb and into the vehicle. (See figure 6.) In some vehicles, you may route the cable through the same grommet that carries power window and power lock wires.

Front or Middle Mounting Option

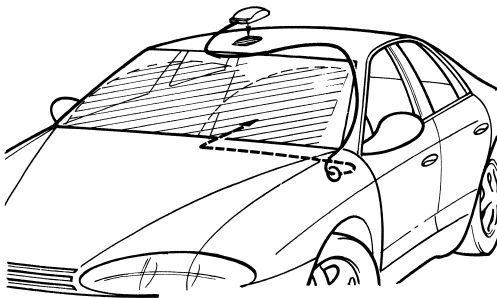

Figure 6. Route XM Antenna through windshield as shown.

If the antenna cable does not fit easily through the grommet, do not try to force it through; instead, route the cable under the weather seal near the bottom of the door.

- For antennas mounted at the rear of the roof, route the cable into the trunk as shown in figure 7. Always use the weather seal at the lowest part of the trunk to reduce water leaks.
- Use pre-existing wiring channels when possible.

Rear Mounting Option

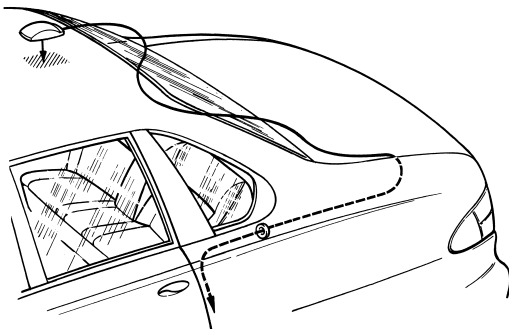
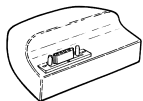

Figure 7. Route XM Antenna wiring as shown.

SKYFi2 Home Adaptor Kit (SA10103) Setup

Your Delphi XM SKYFi2 Home Kit contains the following components:



SKYFi2 Home Stand



XM High-gain Indoor/Outdoor Home Antenna with 25 ft. cable

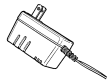

6V AC power adaptor



Audio cable

Hooking up Your SKYFi2 Receiver Home Stand

Note: See *SKYFi2 User Guide* for important user information.

Caution: Connect only the appropriate input devices to the SKYFi2 Home Adaptor Kit jacks. Connecting any incorrect input device may damage the system and/or the external electronic device. It is recommended that you use only the AC power adaptor that came with your SKYFi2 Home Adaptor Kit. If you need to use a different adaptor, it must be a 6V, 1000 mA DC adaptor and must contain a unified polarity-type jack, identified by the  symbol.

Figure 8. SKYFi2 Home Adaptor Kit components.

Installation instructions:

1. Turn off both your SKYFi2 Receiver and home stereo.
2. Connect cables as illustrated in figure 9.
3. Position the XM Antenna so that it is facing south. Ideally, it should point through a window.
4. Turn on your SKYFi2 Receiver and the stereo. Tune to XM channel 1. You should be able to hear the XM Preview channel. If not, check all connections.

Note: The Delphi SA10006 Antenna Extension Cable (sold separately) is designed to work with the SKYFi2 Home Adaptor Kit and provides an additional 50 feet of cable length to the standard XM Home Antenna.

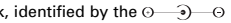
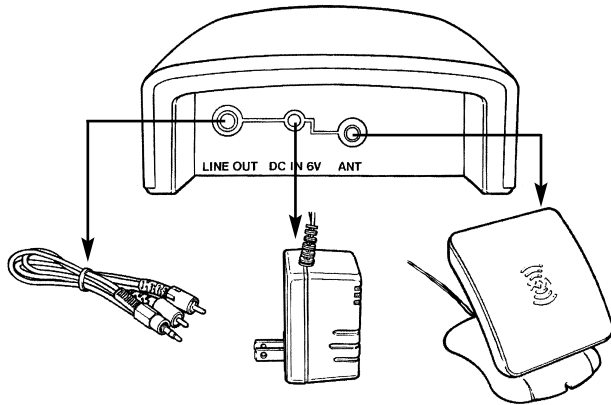

Figure 9. Connect the SKYFi2 Home Stand to power, antenna, and home stereo as shown.

Aiming the XM Home Antenna

For best reception, aim the home antenna by following these instructions:

1. Press the **"menu"** button on the SKYFi2 Receiver.
2. Use the scroll wheel to select the "Antenna Aiming" option. Press the **"XM"** button to confirm selection.
3. This display will remain on until you press the **"menu"** button again, so you have plenty of time to aim the antenna. Slowly turn and tilt the antenna. The "satellite" and "terrestrial" signal bars will

change. Find the position that gives the strongest signal strength (at least two bars) on *either* "satellite" or "terrestrial."

4. Once you are convinced you have determined the proper position to receive the best possible signal, press the **"menu"** button to return to normal operation.

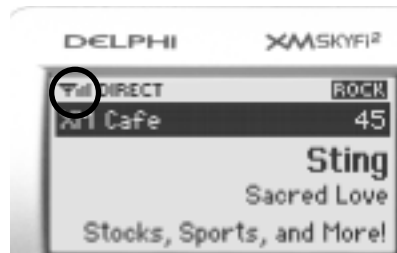

Figure 10. Signal strength indicator.

Delphi Limited Consumer Warranty

Delphi Product and Service Solutions (“Delphi”) warrants all Portable XM Satellite Radio Accessory Products sold by Delphi (each “Product”) to be free of defects in material and workmanship, subject to the following conditions:

The duration of Delphi’s warranty with respect to each product is limited to one (1) year from the date of sale to the original consumer purchaser.

No other express warranties are made with respect to any Product. All implied warranties, including warranties of merchantability and fitness for a particular purpose are limited to the warranty period set forth above. This warranty is not transferable and applies only to the original consumer purchaser of the Product.

Delphi will, as its sole obligation under this warranty, replace or repair, at its option, any Product that does not conform to this warranty. Products may be repaired or replaced with new or with refurbished items. This limited warranty does not cover defects in appearance, cosmetic or decorative items, including any non-operative parts. Under no circumstances will Delphi be liable for any incidental or consequential damages under this warranty or any implied warranties. These remedies are the customer’s exclusive remedies for breach of warranty. This limited warranty only extends to customers who purchase the Products in the United States.

Delphi will not be responsible for damage resulting from any (i) deviation from Delphi’s operating instructions as printed in Delphi’s catalog or on any packaging, labels, or other literature provided with a Product, (ii) installation of a Product in a manner which is inconsistent with Delphi’s written instructions, (iii) alteration or modification of a Product, (iv) misuse, (v) neglect, (vi) abuse, (vii) accident, (viii) normal wear and tear, (ix) commercial use, (x) improper storage, (xi) environmental conditions, including excessive temperature or humidity, (xii) service by anyone other than a Delphi authorized repair facility, (xiii) other improper application, installation or operation of the Product, or (xiv) defects or malfunctions of which Delphi is not advised within ten (10) days of the expiration of the limited warranty period.

How you (the Customer) can get service:

To obtain warranty service, you must return the defective Product with the original receipt to the original place of purchase. If further clarification or additional information is required from Delphi, you may call Delphi at: 1.877.GO DELPHI (1.877.463.3574). If warranty service is needed at any time during the warranty period, the purchaser will be required to furnish a sales receipt/proof of purchase indicating the date of purchase, amount paid and place of purchase. Customers who fail to provide such proof of purchase will be charged for the repair/replacement of any Product.

How state law relates to the warranty:

Some states do not allow limitations on the duration of implied warranties, or the exclusion or the limitation of incidental or consequential damages. So the above limitations or exclusions may not apply to you. This warranty gives you specific legal rights. You may also have other rights that may vary from state to state. NO PERSON IS AUTHORIZED BY DELPHI TO MODIFY OR ADD TO THIS LIMITED WARRANTY.

DELPHI

Delphi Corporation
1441 West Long Lake Road
Troy, Michigan 48098-5090
U.S.A.
Customer Service: [1] 877.GO DELPHI

www.delphi.com

The SKYFI2 name, XM name, TuneSelect, and related logos are trademarks of XM Satellite Radio Inc. All other trademarks are the property of their respective owners.