

JVC

DLA-X90R

DLA-X70R

DLA-X30

D-ILA Projectors

X

Series



4K
e-shift

3D



The Power of 4K* Image Display — Super High-Definition Picture that Surpasses Full HD.

4K
e-shift

Unprecedented visual sensations can now be realised with 4K-resolution realism as if one is actually immersed into the picture. JVC's professional projector business nurtured by its high-definition expertise has been integrated with e-shift technology to enhance the potential of home theatre projectors. The incredible picture resolution of 4K projection surpasses that of full high-definition to ensure a masterful reproduction of details as well as clear, realistic representations of texture. Now everyone can enjoy a remarkable viewing experience like that never before seen in a home cinema environment.

*3,840 x 2,160 pixels

Super High-definition 4K Projection (3,840 x 2,160 pixels)

In addition to a full HD D-ILA device, the DLA-X90R and X70R feature a newly developed optical engine incorporating the new e-shift technology to realise super high-definition projection of 4K-resolution (3,840 x 2,160 pixels). Resolution in the vertical and horizontal directions is virtually doubled thanks to e-shift technology, which shifts one pixel for every 0.5 pixels to realise 4K projection.

Unlike a resolution-upscaling technology for full HD projectors, the use of a device that is capable of displaying 4K-resolution (3,840 x 2,160 pixels) drastically improves picture quality to ensure exceptional precision and full presence.

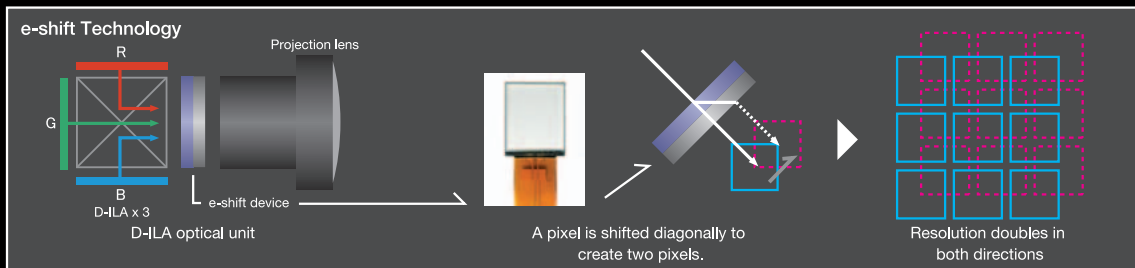
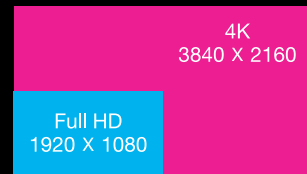

Illustrated representation of pixel shift

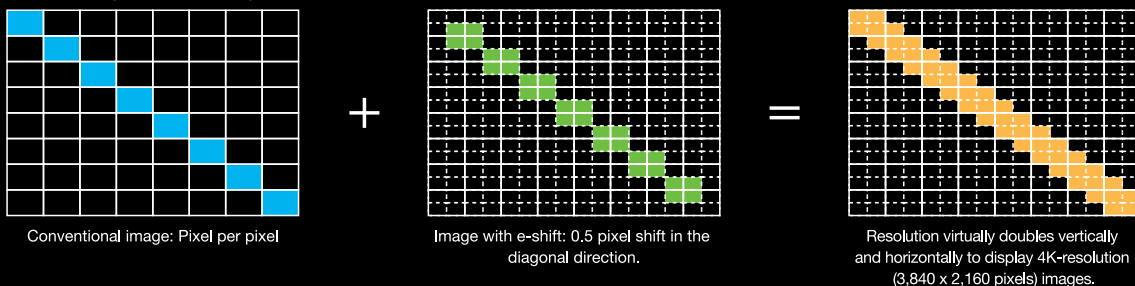

JVC's Original Advanced image-processing Technologies

JVC's advanced image-processing technologies ensure high definition through the use of precise detection and restoration algorithms. The former analyzes pixel information within different areas of the frame; the latter

restores the high-frequency components that are missing in a low-resolution image. Further quality enhancement is achieved via contrast correction and jaggy reduction. The overall result is a picture that looks real down to the smallest detail.

Original



Close-up view

Original	Results of JVC technologies
Jaggies are eliminated in diagonal sections for sharper images.	
Faithful reproduction of contrast even for intricate details.	
Clearer images with reduced noise and less blur.	

D-ILA 3D Projection Leaps Forward in Quality.



Fully equipped with an array of beneficial 3D functions such as 2D-3D conversion and 3D picture adjustment, JVC's D-ILA projectors take a significant leap forward in picture quality by delivering a more realistic 3D video experience packed with presence.

Frame Addressing — the D-ILA Method

Thanks to JVC's original D-ILA driving method, Frame Addressing reproduces more colourful and vivid 3D video content with reduced crosstalk (image overlapping). What's more, this technology incorporates newly developed driving circuitry that helps to drastically improve image brightness. This means that with JVC's D-ILA projectors, anyone can enjoy breathtaking and impressive 3D video content just like that seen at cinemas, right in the comfort of their living rooms.

An alternative driving method known as "line addressing"

utilises a fast-shutter approach, but when the shutters are switched between the left and right eyes, crosstalk can be generated where the left and right images overlap. This is because the shutter on 3D glasses is opened for a shorter amount of time compared to the D-ILA method, causing the picture to darken and lose brightness. However, JVC's Frame Addressing driving method draws images in a single frame at one time to enable the shutter on the 3D glasses for one eye to remain open for an extended period to realise a brighter 3D picture with less crosstalk.

Frame Addressing

Image overlapping (crosstalk) is reduced because the shutter on 3D glasses can be left open longer as the method draws each frame of the picture individually.

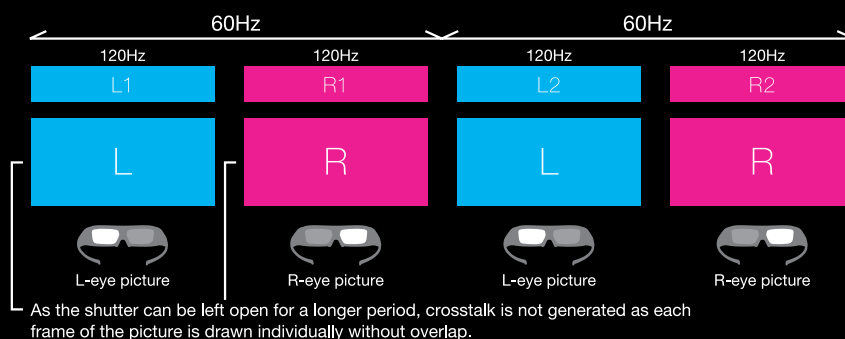

Line Addressing

Crosstalk can be generated when shutters are switched between the left and right eyes, and opened only for a short amount of time. This can cause the picture to darken and lose brightness.

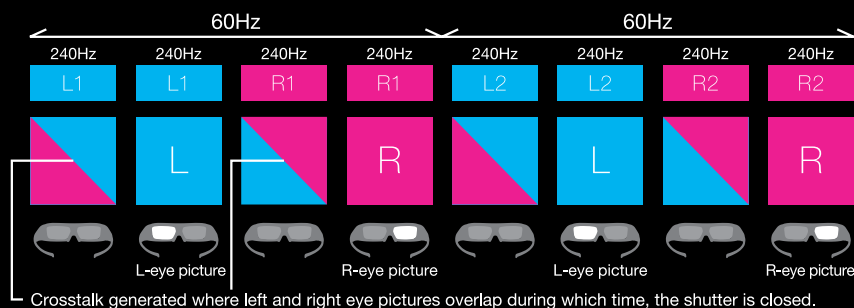

Crosstalk Cancelling

The innovative Crosstalk Cancelling function drastically reduces crosstalk from intensity levels that are likely to generate this phenomenon by first analysing the video signal for the left and right eyes and then correcting the levels via an original algorithm. This ensures the reproduction of more natural and clear pictures that are easier on the eyes to heighten the viewing enjoyment of more realistic 3D video content.



Crosstalk Cancelling OFF



Crosstalk Cancelling ON

Disparity Adjustment

To adjust for the parallax difference between each eye, this function finely controls image disparity between the left eye and right eye to ensure more natural stereoscopic reproduction with less distortion.



Disparity adjustment LOW



Disparity adjustment HIGH

2D-3D Conversion

The real-time 2D-3D converter featured on JVC's IF-2D3D1 Professional 3D Image Processor, which has earned an excellent reputation in film and 3D video production/editing studios, has been modified for home projector use and is now featured on the DLA-X90R/X70R/X30 projectors. This means that 2D video recorded on camcorders and from TV broadcasts can be converted into 3D video instantaneously for home stereoscopic viewing enjoyment.



Depth Adjustment:

3D effects, especially depth characteristics, can be adjusted to match the content source or viewer preferences.

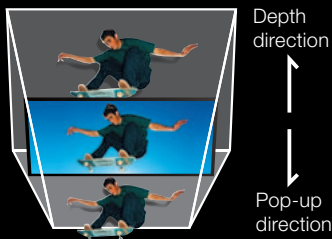

Subtitle Adjustment :

Subtitle distortion generated during 2D-3D conversion can be rectified.

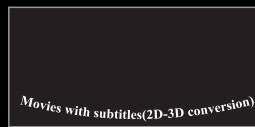

Subtitle Adjustment OFF

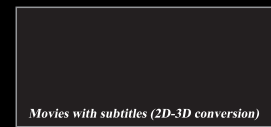

Subtitle Adjustment ON

Options to Enjoy 3D Viewing



PK-AG1 3D Glasses

- Battery operation
- Weighs only 56g with battery
- Continuous operation approx. 75H



PK-AG2 3D Glasses

- Rechargeable
- Lightweight only 40g
- Continuous operation approx. 40H



PK-EM1 3D Synchro Emitter

- Supplied with 3m connection cable
- Weighs 160g
- Emitter dimensions: 80 x 50 x 90mm (including the stand)

Notes about viewing 3D video content

- The optional 3D Synchro Emitter and 3D glasses are required to view 3D images from the D-ILA projectors. 3D video software (3D media or output of 3D broadcasts) and a 3D-compatible video player are also required.
- Perception of 3D images will vary with individual viewers.
- Stop viewing 3D images immediately if any discomforts such as headaches, dizziness, eye fatigue, etc. occur.
- Viewing of 3D images by children under the age of five is not recommended.
- Read the Safety Precautions in the User Manual carefully before viewing any 3D source.

Cinema-like Quality Realised by D-ILA

Native Contrast Ratio

A high native contrast ratio is achieved by an enhanced optical engine featuring JVC's original D-ILA device and a wire grid. The D-ILA method features a wide video dynamic

range to display peak whites and deep blacks on the same field of a picture, helping to realise remarkable presence with smoother greyscale and increased depth.

JVC's Unique Real Colour Imaging Technology (DLA-X90R/X70R)

Real Colour Imaging Technology accurately detects film colour specifications to optimise colour replication and

heighten picture quality to reproduce colours that are as faithful to the original source as possible.

Exclusive Colour Profile

JVC has succeeded in creating an exclusive colour profile from video content by accurately analysing colour information to reproduce images faithful to the original source. By combining this colour profile with the array of picture modes, users can enjoy up to twelve different levels of picture quality.

Wide Colour Space

Real Colour Imaging Technology features a colour space wider than that of Adobe RGB to vividly reproduce a fuller spectrum of colours such as the green of trees, the blue of oceans, etc., which was difficult to recreate accurately up until now.

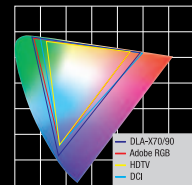

Xenon-lamp Colour Temperature Setting

Real Colour Imaging Technology also incorporates a Xenon-mode colour temperature setting equivalent to that of a Xenon lamp, a popular light source used in cinemas. This setting allows for the authentic reproduction of colours similar to those of film in cinemas, while using highly efficient and economical ultra-high pressure mercury lamps.



Conventional colour temperature setting



Xenon-mode colour temperature setting

Colour Management System with 7-axis Matrix (DLA-X90R/X70R)

A 7-axis matrix of red, green, blue, cyan, magenta, yellow, and orange ensures the precise adjustment of hue, saturation, and intensity. The last axis of orange helps in enhancing the selection of the colour spectrum for skin tones. And for improved operability, only the colour being adjusted will be shown on the screen while the others are displayed in black and white.



The colour being adjusted is shown in colour.

Screen Adjustment Modes*

Reflective characteristics that differ from screen to screen are precisely analyzed and the projector selects the best mode to match the screen being used. With the appropriate mode* selected, the picture displayed will always be precisely adjusted to ensure excellent image reproduction with natural colour balance.



Screen adjustment mode Off



Screen adjustment mode On

*The DLA-X30 has three selectable modes; the DLA-X90R/X70R offers 101 modes but with a firmware update, it provides a maximum of 255 modes. Please refer to the JVC website for a comparison table of primary screens and adjustment modes.

JVC's Original Picture Tone Function (DLA-X90R/X70R)

The Picture Tone function works to balance gamma, contrast, and brightness settings without affecting the grey scaling of the original source to enable brightness adjustment that better matches the surrounding environment.



An Array of Convenient Functions

Lens Memory Function

This function records up to three separate lens adjustments for zoom, shift and focus that can be easily recalled when needed. Focus, zoom (size) and shift (display position) characteristics can be recorded for video content in different aspect ratios such as when using a CinemaScope screen size (2.35:1) or standard 16:9 screen and readily switched between each setup via the remote controller.

Lens memory examples
(when using CinemaScope screen)



Memory 1: Standard 16:9



Memory 2: CinemaScope size



Memory 3: CinemaScope size with subtitles outside of the screen

Pixel Adjust Function

The Pixel Adjust function allows users to precisely correct colour deviation in 1/16-pixel increments*, and it is also capable of segmenting the entire screen into 121 points and adjust them individually to realise clearer video without colour deviation.



Pixel Adjust OFF

Pixel Adjust ON

*DLA-X30 enables adjustment in 1-pixel increments.

A Wide Range of Inputs and Outputs

In addition to 3D compatible HDMI inputs, the projector features an array of other connections, such as an RJ45 socket for projector control, firmware and configuration updates, and a trigger socket for an anamorphic lens or motorised screen.

Unique Automatic Lens Cover (DLA-X90R/X70R)

A unique automatic lens cover opens and closes upon power On/Off to protect against dust or damage to ensure users of easy, trouble-free operation via the remote controller, even if the projector is installed on the ceiling.



Lens cover closed (power off)



Lens cover open (power on)

Flexible Installation Guaranteed

The flexible installation is made possible thanks to the $\pm 80\%$ vertical and $\pm 34\%$ horizontal powered lens-shift function. The projector also features a high-performance 2X zoom lens with motorised focus that can project images upon a large 100-inch screen at distances of between 3.0 and 6.1 metres. With the high-performance motor, the once tedious tasks of setting zoom ratios and focus adjustments are now made simple and effortless.

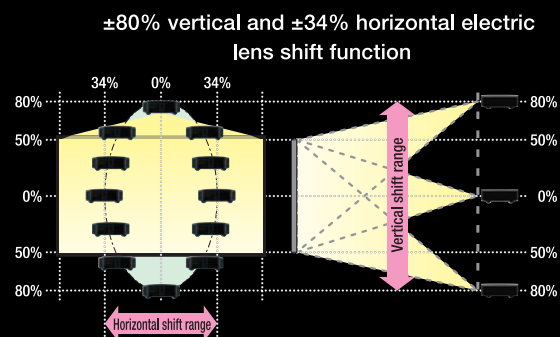

The vertical and horizontal lens shift function cannot be set to the maximum values simultaneously.

Industry Certified Projectors (DLA-X90R/X70R)

THX 3D Display Certification^{*1}

The DLA-X90R and X70R are accredited with THX 3D Certification, which is established to ensure the precise reproduction



of picture quality in home environments for both 2D and 3D content just as the original filmmaker envisioned. Encompassing more than 400 laboratory tests to evaluate a projector's colour accuracy, cross-talk, viewing angles and video processing, this certification helps to guarantee high-definition quality.

*1 Ideal 3D screen-size performance is 90 inches diagonal (16:9).

Certified by ISF (Imaging Science Foundation)

The DLA-X90R and X70R are licensed with the ISF C3 (Certified Calibration Controls) mode, enabling trained dealers to professionally calibrate them



to desired screen surfaces, lighting environments and video sources, and then securely store these precise settings into the projector. This not only helps to ensure the reproduction of film or video content accurate to the source but also excellent picture quality optimised for specific environments.

The Top-of-the-line PREMIUM D-ILA Projector

The name D-ILA itself speaks of high-quality home cinema projectors, but the DLA-X90R represents a step above the rest in terms of exquisite image reproduction. Incorporating a select choice of premier components and technologies, the DLA-X90R offers remarkable levels of picture quality with its 4K-resolution and a native contrast ratio of 120,000:1.

Viewing Setting to Match the Environment

The DLA-X90R's premium picture quality can be further enjoyed by creating an original viewing setting using JVC exclusive software and a commercially available optical sensor. For example, when the interior environment of a white wall or indirect lighting affects the quality of the projected picture, application of the software and an optical sensor on the DLA-X90R can easily create an optimum viewing setting by minimizing undesirable effects, allowing everyone to enjoy a premium level of outstanding picture reproduction.



Auto-calibration Function

Colour balance gaps that can occur when the projector is being used for extended periods of time are calibrated with a click using an optical sensor to ensure superlative image reproduction at all times.



Immediately after purchase



After 1,000 hours of use



After auto calibration

Picture Data In / Out

Customised picture data can be transferred from the projector and stored onto a PC; picture data can also be uploaded from a PC to the projector via a LAN terminal.

Exclusive Software / Commercially Available Optical Sensor

Exclusive JVC software installed on a PC connected to the DLA-X90R via a LAN connection and an optical sensor are required to set viewing configurations and auto calibration.

- **Software compatible OS:** Microsoft® Windows® XP 32-bit (SP2 or later), Windows Vista® 32-bit, Windows® 7 32-bit/64-bit.
- **Software:** Download for free from our corporate website.

- **Optical sensor:** Spyder3Pro™ or Spyder3Elite™ by Datacolor. For details on the Spyder3Pro and Spyder3Elite, please refer to the product brochures or website.

* Spyder3Pro, Spyder3Elite are trademarks of Datacolor in the U.S. and other countries.



Commercially Available Optical Sensor

Distinguished PREMIUM D-ILA Projector

Equipped with special features only available on the Premium line-up, the DLA-X90R is an opportunity to experience the full potential of limited-edition specifications.

4K Projection

In addition to a HD D-ILA device, the newly developed optical engine features new e-shift technology to realise a super high-definition 4K (3,840 x 2,160 pixels) display. This means that unlike a resolution-upscaling technology for full HD projectors, 4K display performance drastically improves picture quality to ensure exceptional precision and full presence.

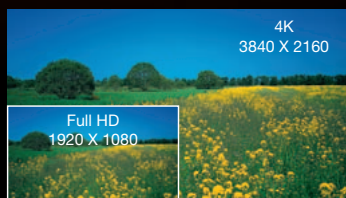

Exceptionally High Native Contrast Ratio of 120,000:1

As a top-of-the-line D-ILA projector, the DLA-X90R delivers ultimate performance in all aspects of image reproduction, including the industry's highest native contrast ratio of 120,000:1*. This extraordinary figure is realised by reducing unnecessary light leakage from the optical engine, which is comprised of an original D-ILA device, wire grid, and other innovatively assembled components/devices.



Conventional projector



DLA-X90R

*As of November 2011.

4K-resolution D-ILA Projector with 3D Viewing

DLA-X90R

- 3D compatibility
- Variety of 3D functions: 2D-3D conversion, crosstalk cancelling, depth adjustment, etc.
- Adobe RGB colour space
- Xenon-lamp colour temperature
- Clear Motion Drive
- 7-axis Colour Management
- Screen Adjustment modes (Max. 255 modes)
- Picture Adjustment functions: Picture Tone, Black Level, Darkness and Lightness Correction
- Lens Memory function
- Pixel Adjust function (1/16-pixel increments)
- Motorised lens cover
- Digital keystone*
- THX 3D Certification
- ISF Certification

*Operates only in 2D mode.

4K
e-shift

D-ILA

3D

THX 3D
DISPLAY

isf
ccc

4K-resolution	Native contrast ratio 120000:1	Brightness 1200lm	3D-compatible	2D-3D conversion	Clear Motion Drive	7-axis Colour Management	Xenon-lamp Colour Temperature
Screen Adjustment (max 255 modes)	THX Certified	ISF	Pixel Shift (1/16-pixel increment)	Lens Memory	Motorised Lens Cover	Auto Calibration	Picture Data In / Out

High-definition Projector that Perfectly Replicates Movie Quality.

4K Projection*, Native Contrast Ratio of 80,000:1,
and Various Features for an Impressive Picture.



4K-resolution D-ILA Projector with 3D Viewing

DLA-X70R

- **4K** (3,840 x 2,160 pixels) D-ILA projector
- High native contrast ratio of **80,000:1**
- Minimised crosstalk for brighter, more realistic 3D picture
- 2D-3D conversion creates dynamic 3D video content from 2D video sources
- JVC original Real Colour Imaging Technology
- Various picture adjustment functions ensure a high-quality picture
- Convenient lens memory function
- Pixel Adjust function corrects colour distortion in 1/16-pixel increments
- Motorised lens cover automatically opens or closes the lens

*3,840 x 2,160 pixels

4K
e-shift

D-ILA

3D

THX 3D
DISPLAY

isf
ccc

4K-resolution	Native contrast ratio 80000:1	Brightness 1200lm	3D-compatible	2D-3D conversion	Clear Motion Drive	7-axis Colour Management	Xenon-lamp Colour Temperature
Screen Adjustment (max 255 modes)	THX Certified	ISF	Pixel Shift (1/16-pixel increment)	Lens Memory	Motorised Lens Cover		

Remarkable Picture Quality Even in a Well-lit Room.

1,300-lumen Brightness Level and a Native
Contrast Ratio of 50,000:1.



D-ILA Projector with 3D Viewing
DLA-X30

- **1,300-lumen** brightness level and **50,000:1** native contrast ratio
- Bright, high-definition 3D picture without crosstalk made possible by D-ILA
- 2D-3D conversion creates dynamic 3D video content from 2D video sources
- Convenient lens memory function
- 16-step aperture function adjusts brightness
- Pixel Adjust function corrects colour distortion in 1-pixel increments
- 2X motorised zoom lens for flexible installation
- Screen Adjustment modes (3 modes)
- Clear Motion Drive ensures smoother picture reproduction
- Available cabinet colours: Black and white



Native contrast
ratio **50000:1**

Brightness
1300lm

3D-
compatible

2D-3D
conversion

Clear Motion
Drive

Screen
Adjustment
(3 modes)

Pixel Shift
(1-pixel
increment)

Lens Memory

Projection Distance Chart

Screen diagonal (inch)	Display size (16:9)		Projection distance	
	W (mm)	H (mm)	Wide (m)	Tele (m)
60	1,328	747	1.78	3.66
70	1,549	872	2.09	4.28
80	1,771	996	2.40	4.89
90	1,992	1,121	2.70	5.51
100	2,214	1,245	3.01	6.13
110	2,435	1,370	3.31	6.75
120	2,656	1,494	3.62	7.36
130	2,878	1,619	3.92	7.98
140	3,099	1,743	4.23	8.60
150	3,320	1,868	4.53	9.22
160	3,542	1,992	4.84	9.84
170	3,763	2,117	5.14	10.45
180	3,984	2,241	5.45	11.07
190	4,206	2,366	5.75	11.68
200	4,427	2,490	6.06	12.30

*Projection distances are design specifications, so there is ±5% variation.

Main Features

	DLA-X30	DLA-X70R	DLA-X90R
4K Projection	-		●
3D Capability		●	●
2D-3D Converter		●	●
Aperture		16 steps	
Clear Motion Drive		●	
Color Management			● (7-axis)
Colour Temperature (Xenon-lamp Mode)	-		●
Picture Tone	-		●
Darkness and Lightness Correction	-		●
Pixel Adjust	● (by 1-pixel increment)	● (by 1/16-pixel increment)	
Screen Adjustment Modes	3 modes		Max: 255 modes
THX Certification	-		● THX 3D
ISF	-		●
Anamorphic Mode	-	●	
Initial Calibration ¹	-		●
Auto Calibration ¹	-		●
Picture Data In/Out	-		●
Lens Memory		● (3 memory)	
Digital Keystone ²		●	
Motorised Lens Cover	-		●

¹ Requires a commercially available optical sensor. ² Digital keystone cannot be used in 3D mode.

Specifications

	DLA-X30	DLA-X70R	DLA-X90R	
Device	0.7 inch Full HD D-ILA (1920 x 1080) x3			
e-shift Technology	-	Yes		
Resolution	1920 x 1080	3840 x 2160 ¹		
Lens	x2 Zoom & Focus: Motorised f=21.4-42.8mm / F3.2-4			
Lens Shift	±80% Vertical and ±34% Horizontal (motorised)			
Light Source Lamp	220W Ultra-High Pressure Mercury Lamp (lamp life: approx. 3000 hours when the lamp is in Normal mode)			
Brightness ²	1,300lm	1,200lm		
Contrast Ratio	Native: 50,000:1	Native: 80,000:1	Native: 120,000:1	
Connectors	Component	1 (RCA: Y, Pb/Cs, Pr/Cr)		
	HDMI	2 (3D/Deep Colour/CEC compatible)		
	Analogue RGB PC	-	1 (D-sub15pin)	
	RS-232C	1 (D-sub 9pin)		
	LAN (RJ-45)	1		
	Trigger	1 (Mini jack, DC12V/100mA)		
Remote	1 (Mini jack)			
3D Sync	1 (Mini Din 3pin)			
Video Input Signal Format	Digital	480i/p, 576i/p, 720p 60/50, 1080i 60/50, 1080p 60/50/24		
	Analogue	480i/p, 576i/p, 720p 60/50, 1080i 60/50		
PC Input Signal Format	HDMI	VGA/SVGA/XGA/WXGA/WXGA+/SXGA/WXSGA+/WUXGA		
	Analogue RGB (D-sub 15 pin)	-	VGA/SVGA/XGA/WXGA/WXGA+/SXGA/SXGA+/WXSGA+/1920x1080/Mac 13", 16" 19"	
3D Format	Frame Packing	720p 60/50, 1080p 24, 1080i 60/50		
	Side-by-Side (half)	720p 60/50, 1080p 60/50, 1080i 60/50		
	Top & Bottom	720p 60/50, 1080p/24		
Noise	20dB (Lamp normal mode)			
Power Requirement	AC 110-240V, 50/60Hz			
Power Consumption	330W (Stand-by: 0.8W)	360W (Stand-by: 0.8W)		
Dimensions	455x179x472 mm			
Weight	14.9kg	15.4kg	15.4kg	

¹ Resolution is 1920x1080 at 3D mode. ² Measurement, measuring conditions, and method of notation all comply with ISO 21118.

Optional Equipment



User-replaceable Lamp
PK-L2210U



3D Glasses
PK-AG2
Rechargeable Type



3D Glasses
PK-AG1
Battery-operated Type



3D Synchro Emitter
PK-EM1

Connectors



DLA-X30



DLA-X70R/X90R

External Dimensions (unit: mm)

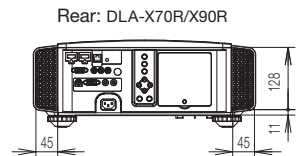
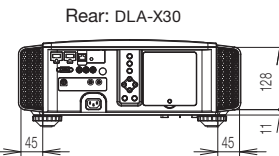
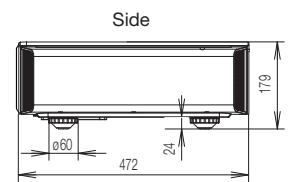
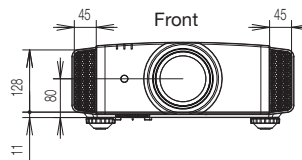
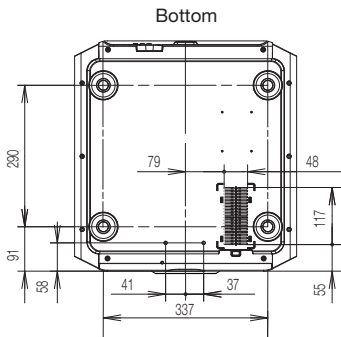
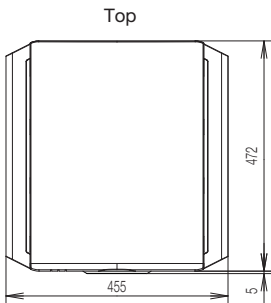

• The projector is equipped with an ultra-high pressure mercury lamp, which may break, emitting a loud noise, when it is subjected to shock or after it has been used for some length of time. • Please note that, depending on how the projector is used, there can be considerable difference between individual lamps regarding how many hours they will operate before requiring replacement. • An additional payment is required for installation of a new lamp, if necessary. • The projector lamp requires periodic replacement and is not covered by warranty. • Please be aware that, because the D-ILA device is manufactured using highly advanced technologies, 0.01% or fewer of the pixels may be non-performing (always on or off).

Design and specifications are subject to change without notice. All pictures on this brochure are simulated. Adobe is a trademark or registered trademark of Adobe Systems Incorporated in the U.S. and/or other countries. ISF is a registered trademark of Imaging Science Foundation, Inc. THX and THX logo are trademarks of THX Ltd., which may be registered in some jurisdictions. HDMI, the HDMI logo and High-Definition Multimedia Interface are registered trademarks of HDMI Licensing LLC. Microsoft, Windows, Windows Vista are trademarks or registered trademarks of Microsoft Corporation in the U.S. and other countries. All other brand or product names may be trademarks and/or registered trademarks of their respective owners. Any rights not expressly granted herein are reserved.

Copyright © 2011, JVC KENWOOD Corporation. All Rights Reserved.

JVC

DISTRIBUTED BY

www.jvc.eu
www.jvc-asia.com

Printed in Japan
CCN-3715-11

"JVC" is the trademark or registered trademark of JVC KENWOOD Corporation.