



# P470/P370 RF Scanner



## Product Reference Guide





***P470/P370 RF Scanner  
Product Reference Guide***

*72-38495-03  
Revision C  
December 2003*



© 2001-2003 by Symbol Technologies, Inc. All rights reserved.

No part of this publication may be reproduced or used in any form, or by any electrical or mechanical means, without permission in writing from Symbol. This includes electronic or mechanical means, such as photocopying, recording, or information storage and retrieval systems. The material in this manual is subject to change without notice.

The software is provided strictly on an “as is” basis. All software, including firmware, furnished to the user is on a licensed basis. Symbol grants to the user a non-transferable and non-exclusive license to use each software or firmware program delivered hereunder (licensed program). Except as noted below, such license may not be assigned, sublicensed, or otherwise transferred by the user without prior written consent of Symbol. No right to copy a licensed program in whole or in part is granted, except as permitted under copyright law. The user shall not modify, merge, or incorporate any form or portion of a licensed program with other program material, create a derivative work from a licensed program, or use a licensed program in a network without written permission from Symbol. The user agrees to maintain Symbol’s copyright notice on the licensed programs delivered hereunder, and to include the same on any authorized copies it makes, in whole or in part. The user agrees not to decompile, disassemble, decode, or reverse engineer any licensed program delivered to the user or any portion thereof.

Symbol reserves the right to make changes to any software or product to improve reliability, function, or design.

Symbol does not assume any product liability arising out of, or in connection with, the application or use of any product, circuit, or application described herein.

No license is granted, either expressly or by implication, estoppel, or otherwise under any Symbol Technologies, Inc., intellectual property rights. An implied license only exists for equipment, circuits, and subsystems contained in Symbol products.

Symbol, Spectrum One, and Spectrum24 are registered trademarks of Symbol Technologies, Inc. Other product names mentioned in this manual may be trademarks or registered trademarks of their respective companies and are hereby acknowledged.

Symbol Technologies, Inc.  
One Symbol Plaza  
Holtsville, New York 11742-1300  
<http://www.symbol.com>

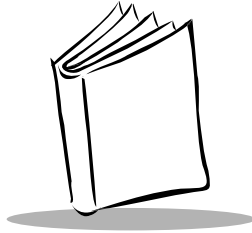

# Contents

## About This Manual

Introduction .....	ix
Chapter Descriptions .....	ix
Notational Conventions .....	ix
Related Publications .....	x
Service Information .....	x
Symbol Support Center .....	xi

## Chapter 1. The P470/P370 RF Scanner

Introduction .....	1-1
Rechargeable Battery .....	1-2
The Cradle .....	1-2
Quick Startup Instructions .....	1-3
Commonly Used P470/P370 Programming Bar Code .....	1-4

## Chapter 2. Set Up

Introduction .....	2-1
Unpacking .....	2-1
Setting Up the Cradle .....	2-1
Connecting to a Host .....	2-1
Wall Mounting .....	2-4
Pairing the Scanner with the Cradle .....	2-6
Optimizing RF Performance .....	2-7
Mounting .....	2-7
Coexistence in Spectrum24 Environments .....	2-7
Phaser-to-Phaser Co-Existence .....	2-8
Charging the Battery .....	2-8
Using the Cradle .....	2-9
Using the UBC 2000 .....	2-9

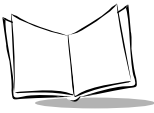

Battery Charge .....	2-9
Charge Status LED Indications .....	2-10
Changing the Battery .....	2-10
Removing the Battery .....	2-10
Replacing the Battery .....	2-11

## Chapter 3. Operation

Introduction .....	3-1
Default Application .....	3-1
Initial Powerup .....	3-2
Scan and Transmit Application .....	3-2
Eliminating Repetitive Scanning .....	3-4
Communication Errors .....	3-5
RF Communication Errors .....	3-5
Host / Cradle Communication Errors .....	3-6
System Menu .....	3-7
123Scan .....	3-17
Suffix Values .....	3-18
Scanning .....	3-22
Scan the Entire Symbol .....	3-22
Hold at an Angle .....	3-23
Decode Zone .....	3-24
Keypad Operation .....	3-26

## Chapter 4. Maintenance And Specifications

Introduction .....	4-1
Maintenance .....	4-1
Troubleshooting .....	4-2
Technical Specifications .....	4-5
Cradle Pin-outs .....	4-7
Beeper Indications / Default Application Error Codes .....	4-8

## Chapter 5. Parameter Menus

Introduction .....	5-1
Operational Parameters .....	5-1
Set Default Parameter .....	5-7
Communication Protocol .....	5-8
Scan & Transmit Application .....	5-8
Host Type .....	5-9
RS-232C Host Types .....	5-9
Host Response Timeout .....	5-12

RF Channel .....	5-13
RF Retries .....	5-13
Sleep Time.....	5-15
Decimal Separator.....	5-16
Key Click .....	5-17
Beeper Tone .....	5-18
Beeper Volume .....	5-19
Power Detect Beep .....	5-20
Beep After Good Decode.....	5-21
Laser On Time .....	5-22
Transmit “No Read” Message .....	5-23
Linear Code Type Security Level.....	5-24
Linear Security Level 1 .....	5-24
Linear Security Level 2 .....	5-24
Linear Security Level 3 .....	5-25
Linear Security Level 4 .....	5-25
Bi-directional Redundancy.....	5-26
Autodiscriminate Response Time .....	5-27
Enable/Disable UPC-E/UPC-A/UPC-E1 .....	5-28
Enable/Disable EAN-8/EAN-13 .....	5-29
Enable/Disable Bookland EAN .....	5-30
Decode UPC/EAN Supplementals.....	5-31
Decode UPC/EAN Supplemental Redundancy .....	5-32
Transmit UPC-A/UPC-E/UPC-E1 Check Digit.....	5-33
UPC-A Preamble .....	5-34
UPC-E Preamble .....	5-35
UPC-E1 Preamble .....	5-36
Convert UPC-E to UPC-A .....	5-37
Convert UPC-E1 to UPC-A .....	5-38
EAN-8 Zero Extend .....	5-39
Convert EAN-8 to EAN-13 Type .....	5-40
UPC/EAN Security Level .....	5-41
UPC/EAN Security Level 0 .....	5-41
UPC/EAN Security Level 1 .....	5-41
UPC/EAN Security Level 2 .....	5-42
UPC/EAN Security Level 3 .....	5-42
UPC/EAN Coupon Code .....	5-43
Enable/Disable Code 128 .....	5-44
Enable/Disable UCC/EAN-128 .....	5-45
Lengths for Code 128 .....	5-46
Enable/Disable ISBT 128.....	5-47
Enable/Disable Code 39 .....	5-48
Enable/Disable Trioptic Code 39.....	5-49
Set Lengths for Code 39 .....	5-50

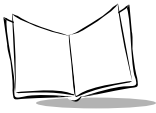

Code 39 Check Digit Verification . . . . .	5-52
Transmit Code 39 Check Digit . . . . .	5-53
Enable/Disable Code 39 Full ASCII . . . . .	5-54
Convert Code 39 to Code 32 . . . . .	5-55
Code 32 Prefix . . . . .	5-56
Enable/Disable Code 93 . . . . .	5-57
Set Lengths for Code 93 . . . . .	5-58
Enable/Disable Interleaved 2 of 5 . . . . .	5-60
Set Lengths for Interleaved 2 of 5 . . . . .	5-61
1 2 of 5 Check Digit Verification . . . . .	5-63
Transmit 1 2 of 5 Check Digit . . . . .	5-64
Convert 1 2 of 5 to EAN-13 . . . . .	5-65
Enable/Disable Discrete 2 of 5 . . . . .	5-66
Set Lengths for Discrete 2 of 5 . . . . .	5-67
Enable/Disable Codabar . . . . .	5-69
Set Lengths for Codabar . . . . .	5-70
CLSI Editing . . . . .	5-72
NOTIS Editing . . . . .	5-73
Enable/Disable MSI Plessey . . . . .	5-74
Set Lengths for MSI Plessey . . . . .	5-75
MSI Plessey Check Digits . . . . .	5-77
Transmit MSI Plessey Check Digit . . . . .	5-78
MSI Plessey Check Digit Algorithm . . . . .	5-79
Transmit Code ID Character . . . . .	5-80
Symbol Code ID Characters . . . . .	5-80
Pause Duration . . . . .	5-82
RS-232C Parameters . . . . .	5-83
Baud Rate . . . . .	5-83
Parity . . . . .	5-85
Check Receive Errors . . . . .	5-87
Hardware Handshaking . . . . .	5-88
Software Handshaking . . . . .	5-91
Host Serial Response Time-out . . . . .	5-94
RTS Line State . . . . .	5-94
Stop Bit Select . . . . .	5-95
ASCII Format . . . . .	5-96
Intercharacter Delay . . . . .	5-96
MCL-Net Parameters . . . . .	5-97
MCL-Net Baud Rate . . . . .	5-97
MCL-Net Hex Addressing Mode . . . . .	5-99
Scanner Address . . . . .	5-100
MCL-Net Transmit Retries . . . . .	5-100
MCL-Net Frame Timeout . . . . .	5-100
Scanner Decode Beep Type . . . . .	5-101



Long Range Scanning Bar Codes .....	5-102
Aim Mode .....	5-102
Aim Duration .....	5-103
Numeric Bar Codes .....	5-104
Cancel .....	5-106

## **Appendix A. Bar Code Information**

UCC/EAN-128 .....	A-1
AIM Code Identifiers .....	A-3

## **Appendix B. Automatic Project Download**

## **Appendix C. Radio Channels**

Cordless Phaser RF Channels Per Country .....	C-1
---	-----

## **Appendix D. Messages and Error Codes**

Introduction .....	D-1
Messages .....	D-1
Communication Errors .....	D-2
Scanning Transmission Range .....	D-2

## **Index**

## **Feedback**

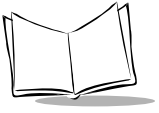

*P470/370 RF Scanner Product Reference Guide*

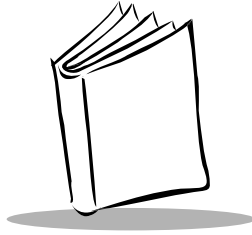

## About This Manual

### Introduction

---

The *P470/P370 RF Scanners Product Reference Guide* provides general instructions for setup, operation, troubleshooting, maintenance, and programming the P370 (industrial) and P470 (retail) cordless RF scanners.

### Chapter Descriptions

---

- [Chapter 1, \*The P470/P370 RF Scanner\*](#), describes the scanner and quick startup instructions.
- [Chapter 2, \*Set Up\*](#), explains how to set up the scanner.
- [Chapter 3, \*Operation\*](#), explains how to operate the scanner.
- [Chapter 4, \*Maintenance And Specifications\*](#), talks about the maintenance and the specifications of the scanner and the cradle.
- [Chapter 5, \*Parameter Menus\*](#), has all the optional parameter bar codes for personalizing your scanner.
- [Appendix A, \*Bar Code Information\*](#), has information about bar codes.
- [Appendix B, \*Automatic Project Download\*](#), describes the AutoLoad feature.
- [Appendix C, \*Radio Channels\*](#), lists the available RF channels per Country.
- [Appendix D, \*Messages and Error Codes\*](#), describes possible error codes displayed on the scanner.

### Notational Conventions

---

The following conventions are used in this document:



- Italics are used to highlight specific items in the general text, and to identify chapters and sections in this and related documents.
- Bullets (•) indicate:
  - action items
  - lists of alternatives
  - lists of required steps that are not necessarily sequential
- Sequential lists (e.g., those that describe step-by-step procedures) appear as numbered lists.

## Related Publications

---

- *P470/P370 RF Scanner Quick Reference Guide*, p/n 72-38493-xx
- *PL 370/470 Cradle Quick Reference Guide*, p/n 72-38494-xx
- *MCL Designer for Phaser Series User's Guide*, p/n 70-37689-xx.

## Service Information

---

If you have a problem with your equipment, contact the [Symbol Support Center](#) for your region. See [page xi](#) for contact information. Before calling, have the model number, serial number, and several of your bar code symbols at hand.

Call the Support Center from a phone near the scanning equipment so that the service person can try to talk you through your problem. If the equipment is found to be working properly and the problem is symbol readability, the Support Center will request samples of your bar codes for analysis at our plant.

If your problem cannot be solved over the phone, you may need to return your equipment for servicing. If that is necessary, you will be given specific directions.

---

**Note:** *Symbol Technologies is not responsible for any damages incurred during shipment if the approved shipping container is not used. Shipping the units improperly can possibly void the warranty. If the original shipping container was not kept, contact Symbol to have another sent to you.*

---

## **Symbol Support Center**

For service information, warranty information or technical assistance contact or call the Symbol Support Center in:

### **United States**

Symbol Technologies, Inc.  
One Symbol Plaza  
Holtsville, New York 11742-1300  
Tel: 1-800-653-5350

### **United Kingdom**

Symbol Technologies  
Symbol Place  
Winnersh Triangle, Berkshire RG41 5TP  
United Kingdom  
Tel: 0800 328 2424 (Inside UK)  
Tel: +44 118 945 7529 (Outside UK)

### **Australia**

Symbol Technologies Pty. Ltd.  
432 St. Kilda Road  
Melbourne, Victoria 3004  
Tel: 1-800-672-906 (Inside Australia)  
Tel: +61-3-9866-6044 (Outside Australia)

### **Denmark/Danmark**

Symbol Technologies AS  
Dr. Neergaardsvej 3  
2970 Hørsholm  
Tel: 7020-1718 (Inside Denmark)  
Tel: +45-7020-1718 (Outside Denmark)

### **Finland/Suomi**

Oy Symbol Technologies  
Kaupintie 8 A 6  
FIN-00440 Helsinki, Finland  
Tel: 9 5407 580 (Inside Finland)  
Tel: +358 9 5407 580 (Outside Finland)

### **Canada**

Symbol Technologies Canada, Inc.  
2540 Matheson Boulevard East  
Mississauga, Ontario, Canada L4W 4Z2  
Tel: 905-629-7226

### **Asia/Pacific**

Symbol Technologies Asia, Inc (Singapore Branch)  
230 Victoria Street #05-07/09  
Bugis Junction Office Tower  
Singapore 188024  
Tel: +65-6796-9600  
Fax: +65-6337-6488

### **Austria/Österreich**

Symbol Technologies Austria GmbH  
Prinz-Eugen Strasse 70 / 2.Haus  
1040 Vienna, Austria  
Tel: 01-5055794-0 (Inside Austria)  
Tel: +43-1-5055794-0 (Outside Austria)

### **Europe/Mid-East Distributor Operations**

Contact your local distributor or call:  
Tel: +44 118 945 7360

### **France**

Symbol Technologies France  
Centre d'Affaire d'Antony  
3 Rue de la Renaissance  
92184 Antony Cedex, France  
Tel: 01-40-96-52-21 (Inside France)  
Tel: +33-1-40-96-52-50 (Outside France)

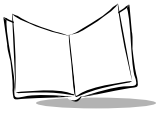

### **Germany/Deutschland**

Symbol Technologies GmbH  
Waldstrasse 66  
D-63128 Dietzenbach, Germany  
Tel: 6074-49020 (Inside Germany)  
Tel: +49-6074-49020 (Outside Germany)

### **Latin America Sales Support**

2730 University Dr.  
Coral Springs, FL 33065 USA  
Tel: 1-800-347-0178 (Inside United States)  
Tel: +1-954-255-2610 (Outside United States)  
Fax: 954-340-9454

### **Netherlands/Nederland**

Symbol Technologies  
Kerkplein 2, 7051 CX  
Postbus 24 7050 AA  
Varsseveld, Netherlands  
Tel: 315-271700 (Inside Netherlands)  
Tel: +31-315-271700 (Outside Netherlands)

### **South Africa**

Symbol Technologies Africa Inc.  
Block B2  
Rutherford Estate  
1 Scott Street  
Waverly 2090 Johannesburg  
Republic of South Africa  
Tel: 11-809 5311 (Inside South Africa)  
Tel: +27-11-809 5311 (Outside South Africa)

### **Italy/Italia**

Symbol Technologies Italia S.R.L.  
Via Cristoforo Colombo, 49  
20090 Trezzano S/N Navigilo  
Milano, Italy  
Tel: 2-484441 (Inside Italy)  
Tel: +39-02-484441 (Outside Italy)

### **Mexico/México**

Symbol Technologies Mexico Ltd.  
Torre Picasso  
Boulevard Manuel Avila Camacho No 88  
Lomas de Chapultepec CP 11000  
Mexico City, DF, Mexico  
Tel: 5-520-1835 (Inside Mexico)  
Tel: +52-5-520-1835 (Outside Mexico)

### **Norway/Norge**

Symbol's registered and mailing address:  
Symbol Technologies Norway  
Hoybratenveien 35 C  
N-1055 OSLO, Norway  
Symbol's repair depot and shipping address:  
Symbol Technologies Norway  
Enebakkveien 123  
N-0680 OSLO, Norway  
Tel: +47 2232 4375

### **Spain/España**

Symbol Technologies S.L.  
Avenida de Bruselas, 22  
Edificio Sauce  
Alcobendas, Madrid 28108  
Spain  
Tel: 91 324 40 00 (Inside Spain)  
Tel: +34 91 324 40 00 (Outside Spain)  
Fax: +34.91.324.4010

**Sweden/Sverige**

“Letter” address:

Symbol Technologies AB  
Box 1354  
S-171 26 SOLNA  
Sweden

Visit/shipping address:

Symbol Technologies AB  
Solna Strandväg 78  
S-171 54 SOLNA  
Sweden

Tel: Switchboard: 08 445 29 00 (domestic)

Tel: Call Center: +46 8 445 29 29 (international)

Support E-Mail:

Sweden.Support@se.symbol.com

If you purchased your Symbol product from a Symbol Business Partner, contact that Business Partner for service.

For the latest version of this guide go to:<http://www.symbol.com/manuals>.

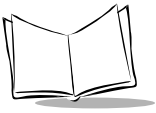

*P470/370 RF Scanner Product Reference Guide*



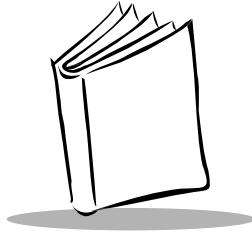

# *Chapter 1*

## *The P470/P370 RF Scanner*

### **Introduction**

---

The P470/P370 cordless RF scanners bring new flexibility and economy to data capture and data management in both industrial and retail operations. The scanner communicates with your host computer through radio transmission instead of through a cable. With the RF scanner, you are free to scan and transmit without a physical cable, from as far away as 100 feet (30.5 meters) even without a direct line of sight. This lets you take the scanner to where the work is, whether on the loading dock, the plant floor, the warehouse, or the POS checkout area. There are several versions available:

- P470: cordless retail scanner
- P370: cordless industrial scanner
- P370 ALR: cordless industrial ALR scanner

Unless otherwise noted, the term Phaser refers to all versions of the scanner.

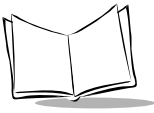

## Rechargeable Battery

---

In the handle of the scanner, there is a rechargeable lithium-ion battery. This provides all power to the scanner during cordless operation. It provides 10 hours of use in a typical application. When fully depleted, the battery can be recharged to full charge in about 3-1/2 hours.

## The Cradle

---

The PL 370/470 Cradle acts as a:

- stand
- 2-way RF transmitter
- communication interface with the host
- battery charger for the cordless scanner.

The cradle can sit on a desktop or be wall-mounted, whichever is more convenient. The cradle receives data from the scanner via the antenna on the side of the cradle. The cradle then transmits that data to the host device via an attached cable. It also acts as a holder for the scanner.

The cradle also provides power for charging the scanner's battery (in the scanner). The cradle has a charge status indicator light that shows the status of the battery charging (Refer to [Table 2-1 on page 2-10](#)).

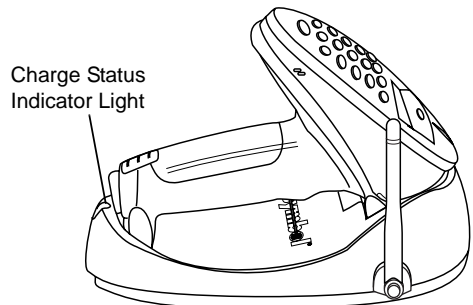

**Figure 1-1. Scanner and Cradle**

There are two versions of the cradle:

- PL 470 Cradle: cordless retail version
- PL 370 Cradle: cordless industrial version.

Unless otherwise noted, the term Cradle refers to both versions of the cradle.

# Quick Startup Instructions

---

Below is an index of Quick Startup Instructions to help get you up and going quickly. These instructions are also on the back cover of this guide for easy reference. The index is listed in a step by step order beginning with step 1, Setting up the System.

Mandatory steps are designated by an asterisk (\*). If an item has multiple pages referenced, the most important reference is in bold.

	<b>PRG Page</b>
<b>1. Setting Up the System</b>	
• Connecting the cradle to a host *	2-1
- RS-232 connection	2-2
- Synapse connection (keyboard wedge, USB, etc.)	2-3
• Charging the battery *	1-2, <b>2-8</b>
• Pairing the scanner with the cradle *	2-6
- RF channel	<b>3-8, 5-13, C-1</b>
- Coexisting in Spectrum24 environments	2-7
<b>2. Using the Default Applications</b>	
• Overview of Scan and Transmit application*	3-2
• Keypad operation	3-2, 3-3, <b>3-26</b>
• Eliminating repetitive scanning	3-4
• Selecting the host communication protocol	3-2, 3-8, <b>5-8</b>
- RS-232 baud rate	5-83
<b>3. Programming an Advanced Data Formatting Rule Using 123Scan</b>	3-17
• Suffix values (appending Enter key and Tab)	3-18
<b>4. Troubleshooting Problems</b>	
• Troubleshooting table	4-2
• Communication errors	3-5, <b>D-2</b>
• Beeper indications and default application error codes	4-8
• Cradle LED indications	2-10



## Commonly Used P470/P370 Programming Bar Code

---

Below are commonly used programming bar codes. You can cut this page out of the guide, or make a copy of the bar codes using a high quality copying machine.

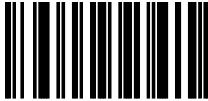

**Enter System Menu Bar Code**

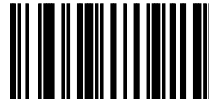

**Load New MCL-Designer Application**

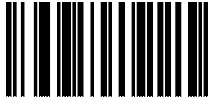

**Scanner Firmware Version**

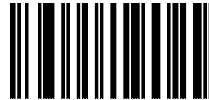

**Cradle Firmware Version**

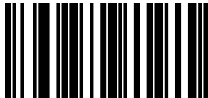

**Load 123Scan File**



**Reset Default Application**  
(Clears previously programmed ADF rules  
and/or MCL-Designer applications)

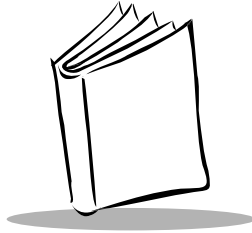

## Chapter 2 Set Up

### Introduction

---

This chapter covers the procedures for setting up the RF scanner and its accessories.

### Unpacking

---

Remove the scanner from its packing and inspect it for damage. If the scanner was damaged in transit, call one of the telephone numbers listed in the section [Symbol Support Center](#) on page xi. KEEP THE PACKING. It is the approved shipping container and should be used if you ever need to return your equipment for servicing.

### Setting Up the Cradle

---

The basic steps to set up the cradle are listed below and described in more detail in the following sections.

- connecting the cradle to a host
- mounting the cradle, if desired
- pairing the scanner to the cradle.

### Connecting to a Host

With some host types, the scanner is unable to answer host terminal polls if the appropriate host type is not selected. This may result in an error message generated by the host. To correct this situation, select the proper parameter set and initialize the host terminal. See [Chapter 5, Parameter Menus](#) for more information.



There are two basic host communications options available:

- using an RS-232 cable
- using a Synapse cable.

## RS-232 Connection

1. Make sure all host devices are powered down.
2. Plug the connector at the end of the cradle's cable into the appropriate RS-232 receiving port on the host device.
3. Plug the other end of the cable into the COM1 connector on the cradle.

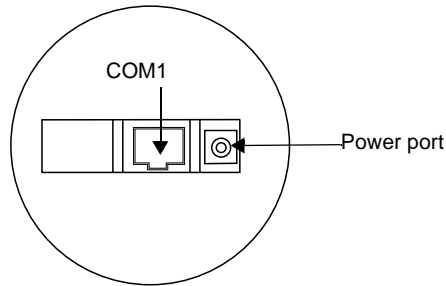

**Figure 2-1. Ports on the Cradle**

4. Connect the power connector of the power supply into the Power port on the cradle.
5. Connect the appropriate line cord to the power supply and into an AC receptacle.
6. The indicator light on the cradle blinks, signifying successful power-up.

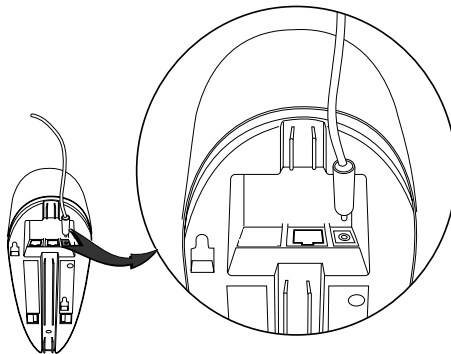

**Figure 2-2. Power Supply Port**

7. Rotate the antenna to the vertical position.

## Using A Synapse Cable

1. Make sure all host devices are powered down.

---

### IMPORTANT

Before power is provided to the cradle (step 6), the following steps must be completed. The Synapse cable must be connected to the cradle (step 2) AND the flying power lead plugged in (step 4). If the cables are not connected in this sequence, the Synapse Interface Adapter will not operate properly.

---

2. Connect the Synapse cable to the cradle (see [Figure 2-1 on page 2-2](#)).
3. Connect the other end of the Synapse cable to the Synapse Interface adapter.
4. The Synapse cable has a flying power lead. Connect this lead to the receptacle in the Synapse Interface adapter, as shown in [Figure 2-3](#). See the Synapse guide for details.

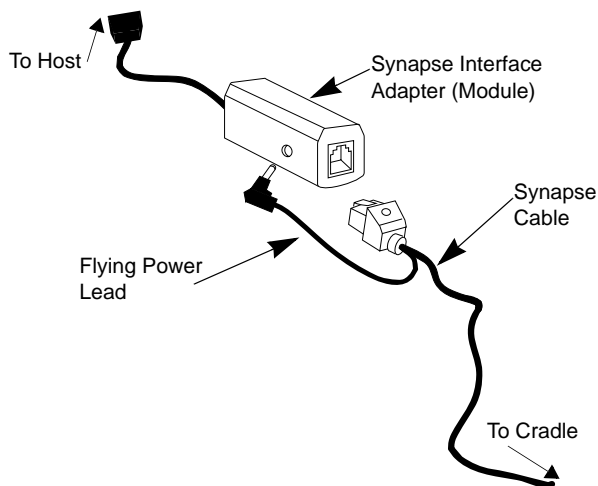

**Figure 2-3. Synapse and Adapter Cable**

5. Connect the Synapse Interface adapter to the host.
6. Connect the power supply to the cradle (see [Figure 2-2](#)).

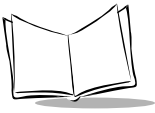

7. Connect the appropriate line cord to the power supply and into an AC receptacle.
8. The indicator light on the cradle blinks, signifying successful power-up.
9. Scan the appropriate Synapse bar codes to set up the Synapse cable for your specifications.
10. Rotate the antenna to the vertical position.

## Wand Emulation, OCIA, OCR, Keyboard Wedges

See the appropriate Synapse cable instructions. An adapter cable is required.

## Wall Mounting

Before wall-mounting the cradle, the scanner support tab must be changed from the desk-mount position to the wall-mount position.

1. Lift the scanner support tab out of the top part of the cradle and replace it in the wall-mount position.

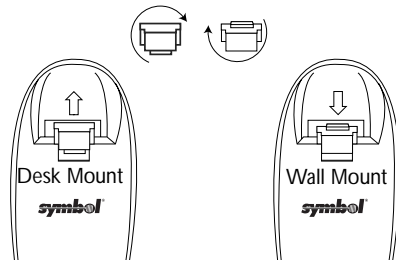

Figure 2-4. Scanner Support Tab

2. Seat the cables from the bottom of the cradle in the grooves along the length of it so that the bottom of the cradle is smooth.

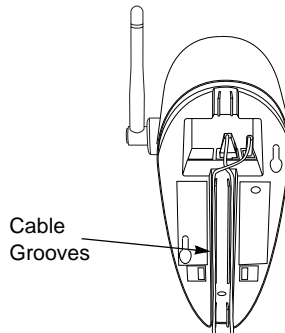
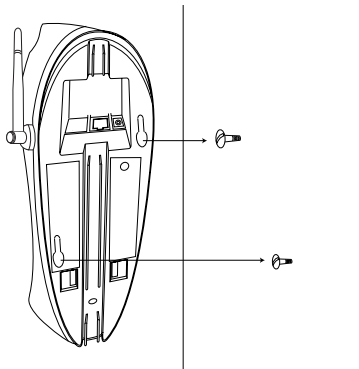

Figure 2-5. Placement of Cables



3. Fasten the two screws provided into the wall where the cradle will hang, leaving about 1/8" (0.3 cm) of the screw outside the wall for the cradle's wall mounting sockets (A template is provided for you in the *PL 370/470 Quick Reference Guide* p/n 72-38494-xx).
4. Place the cradle over the screw heads and slide down until it fits into place. Slight pressure upwards should not move the cradle.



**Figure 2-6. Securing Cradle to Wall**

5. Position the antenna vertically (pointing toward the ceiling).
6. Place the scanner in the cradle.

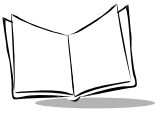

## Pairing the Scanner with the Cradle

The scanner and cradle must be paired for communication to occur.

---

**Note:** *If the cradle is attached to a new host, re-scan the pairing bar code.*

---

To pair the scanner with the cradle:

1. Scan the pairing bar code on the top of the cradle.  
To pair a long range scanner (P370 ALR) to a regular P370 cradle, attach the “spare pairing bar code” label to the cradle. This 15 mil bar code, packaged with the cradle, can be scanned by the P370 ALR at a distance of approximately two feet from the cradle.
2. The scanner may briefly display the “pairing search for channel” message while the scanner searches for the base. Once the base is detected, information is exchanged (addressing, RF channels, etc.) between the scanner and the cradle.

---

**Note:** *It may take up to 30 seconds for the scanner to search for the base during over-the-air pairing. To reduce the pairing time, place the scanner in the cradle.*

---

3. After the exchange is complete, the scanner and cradle are paired.  
Successful pairing is indicated by a **warble** beep and the base’s LED will flash. If pairing is unsuccessful, the scanner emits a Lo/Hi beep and displays the following message:

Pairing Unsuccessful  
Push ENTER & Try Again

The pairing of a scanner to a cradle is one-to-one. Only one scanner can be paired to a cradle at any point in time. If you pair a second scanner to an in use cradle, the cradle’s connection to the first scanner will be broken and the connection re-established with the second scanner.

To pair a scanner to a different cradle, scan its pairing bar code located on the top of the cradle.

## Optimizing RF Performance

---

### ***Mounting***

The RF scanner and cradle are equipped with a 2.4 GHz point-to-point radio that has an RF transmission range of 100 feet (30.5 meters) even without a direct line of sight.

In addition to being a 2-way RF transmitter, the cradle is a battery charger and should be mounted in an accessible location like on a table or desktop. For optimum RF performance, especially in difficult environments, mount the cradle on a wall as high as possible.

### ***Coexistence in Spectrum24 Environments***

If you operate your scanner or cradle in close proximity to a Spectrum24 device, maintain a buffer of 3 feet or greater between the transmitters. A Spectrum24 device includes but is not limited to a terminal with a Spectrum24 radio, PC with a Spectrum24 card, or a Spectrum24 Access Point. If a scanner or cradle is less than 3 ft. from a 2.4 GHz Spectrum24 transmitter (antenna), especially an Access Point, your communication performance may degrade.

### **Select a Channel Outside the Spectrum24 band**

In the unlikely event that Spectrum24 radio traffic causes interference between the scanner and the cradle, you can change the scanner's RF channel to one that minimizes or eliminates the interference.

Phaser cordless scanners have three channels that are not within the Spectrum24 band, 81, 82, and 83\*. As a rule of thumb, the Cordless systems operated closest to Spectrum24 devices should use these channels. For instructions on how to change the scanner's RF channel, see [System Setup Options](#) on page 3-8.

In applications with low scanning/data transmission duty cycles, you may assign the same channel to more than one cordless scanner.

After channels 81, 82 and 83, the next best channels to use are 60 through 80; the higher the channel the better. See [Appendix C, Radio Channels](#) for a list of available radio channels per country.

\* Not available in some countries.



## **Phaser-to-Phaser Co-Existence**

Up to three P470/370 scanners within listening range (100 feet) of each other can be operated on the same channel with little or no interference, assuming average scanning rates.

For higher than average scanning rates, P470/370 scanners within listening range (100 feet) of each other should be operated on different channels, set apart by at least one channel (for example, 2, 4, 6, etc.). Cordless Phaser scanners support up to 82 communication channels. Not all channels are available in all countries. Refer to [Appendix C, Radio Channels](#) for more information.

### **Increase the number of RF Retries**

If the scanner's transmission is not received by the cradle or the base's acknowledgment response is not received by the scanner (see [Communication Errors](#) on page 3-5), the scanner retransmits the lost or corrupted data. The scanner attempts 4 RF Retries (default) but can be programmed to attempt up to 8.

Depending on your particular RF environment, additional retries may cause your scanner transaction time to increase in the presence of heavy Spectrum24 traffic.

## **Charging the Battery**

---

Before its first use, the scanner's battery must be charged. It can be charged:

- Using the cradle
- Using the UBC 2000.

## Using the Cradle

1. Set up the cradle as described in [Setting Up the Cradle](#) on page 2-1..

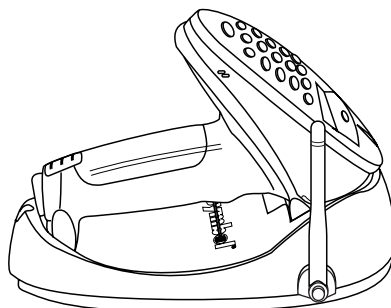

**Figure 2-7. Placing the Scanner into the Cradle**

2. Insert the scanner into the cradle so that the nose of the scanner and tip of the handle seat into the receptacles. The scanner displays “UNIT CRADLED” when properly inserted in the cradle.
3. The battery charges automatically. A full charge of a depleted battery takes approximately 3-1/2 hours.

---

**Note:** For additional information on charging, see [Table 2-1 on page 2-10](#).

---

The cradle recharges batteries in the scanner only when the scanner is in the cradle. A scanner with a depleted battery starts charging immediately upon insertion into the cradle, whereas a scanner with a partially charged battery begins charging after approximately 15 minutes. Note that the scanner can be removed from the cradle at any time.

## Using the UBC 2000

The battery can be charged using the Universal Battery Charger UBC 2000. The UBC adapter for the P470/P370 scanner battery is required. Refer to the UBC 2000 guide for information on recharging the battery using the UBC 2000.

## Battery Charge

---

When the battery’s charge is almost depleted, the scanner emits 4 high tone beeps, when the trigger is pulled, indicating that it must be recharged.



## Charge Status LED Indications

---

The LED indicator on the cradle uses flashing patterns to display the charger status, as shown in the table below.

**Table 2-1. Cradle LED Indications**

LED	Status
Off	The scanner is not in the cradle or has not been properly inserted into the cradle.
Blinking Slowly	The scanner is properly seated in the cradle and charging will begin shortly.
Blinking Rapidly	The battery is actively charging.
On	Battery charging is complete.

## Changing the Battery

---

Once a battery is fully charged, it will generally last up to 10 hours without being returned to the cradle. By returning it to the cradle during the day, you extend this time.

### ***Removing the Battery***

1. Slide the release latch down using center indent and remove the cover.

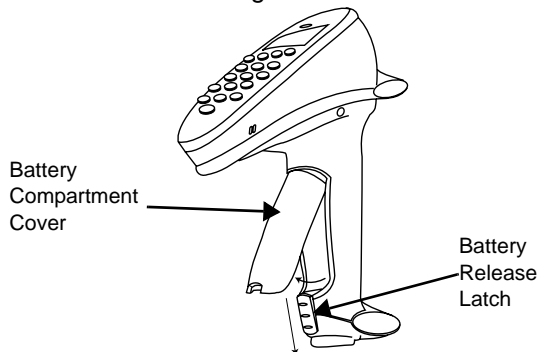

**Figure 2-8. Removing the Battery Compartment Cover**

2. Slide the battery toward the bottom of the scanner and then pull the bottom of the battery back and out of the scanner.

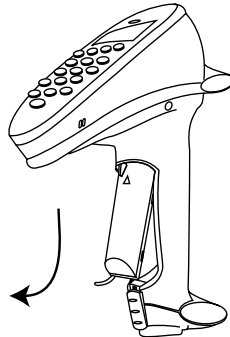

**Figure 2-9. Pulling the Battery Out**

### ***Replacing the Battery***

1. Place the top portion of the battery (curved side up, contacts toward top) into the scanner and then slide it up the handle.
2. Replace the battery compartment cover.
3. Slide the release latch up to secure the cover in place.

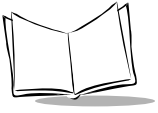

*P470/370 RF Scanner Product Reference Guide*



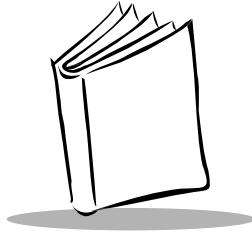

## *Chapter 3*

### *Operation*

## **Introduction**

---

This chapter covers how to use the cordless Phaser scanner.

## **Default Application**

---

The cordless scanner is shipped from the factory with a default scan and transmit application.

This application allows users to scan and view data, enter quantities, and manually enter alphanumeric data.

When the unit is powered up, it displays the system start-up banner. Alternatively, the scanner can be reset manually by pressing the <FUNC> key, then the <\*> key. When the scanner is powered up or reset, the system banner appears as follows:

Symbol Technologies  
Phaser RF

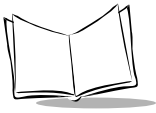

## Initial Powerup

After a few seconds, the System Banner is replaced by the system initialization screen.

Symbol Technologies  
Initializing...

After initialization, the scanner enters the Scan & Transmit application. The default communication protocol is *RS232/Synapse*.

If a Synapse cable is attached, the scanner automatically overrides the default settings.

## Scan and Transmit Application

The scan and transmit application allows you to:

- Display and simultaneously transmit data to a host
- Eliminate repetitive scanning with a quantity entry feature
- Manually enter alphanumeric data if no bar code is present.

If the scanner powers down, pull the trigger or press the <ENTER> key to wake it up.

The scan and transmit screen appears as follows:

SKU:  
\_\_\_\_\_

In this mode, scanned bar codes are automatically transmitted to the cradle and then the host in real time.

## Numeric Data Entry

The default application also allows you to manually enter data if no bar code is present.

By default, this feature is enabled. To disable alphanumeric data entry via the keypad, go to the symbologies tab inside 123Scan and remove the “X” from the check box next to “Keypad”. (This does not disable the quantity entry feature discussed in [Eliminating Repetitive Scanning](#) on page 3-4.)

With keypad entry enabled (default setting out of the box), press the <ENTER> key after keying in data. During data entry, the <BK> key corrects keying errors digit by digit, and the <FUNC> then <BK> combination clears the screen so you can start over. If your entry exceeds 34 characters, the characters will scroll off the visible portion of the screen, but are retained for storage.

## Alpha Data Entry

To enter alpha characters via the keypad (with keypad enabled, page [3-26](#)), press the <Mode> key once to put the scanner in Alpha Mode.

Numeric buttons 1 through 9 are associated with the alpha characters. For example, the letters A, B and C are located on numeric button 7. Press the button with the letter you desire - once for the letter A, twice for the letter B, or three times for the letter C. You can continue entering alpha characters or switch to numerics. Press <ENTER> to send the data.

To return to numeric entry mode after entering alpha characters, press the <Mode> key again. For example, to manually enter **17ABF5**, do the following steps:

Data	Action
<b>1</b>	Press numeric button 1.
<b>7</b>	Press numeric button 7.
<b>A</b>	Press <MODE> button once, then numeric button 7 once. Wait for one second (you will hear a low pitched beep).
<b>B</b>	Press numeric button 7 twice.
<b>F</b>	Press numeric button 8 three times.
<b>5</b>	Press <MODE> button once, then numeric button 5 once, then <ENTER>.

For more information, refer to [Keypad Operation](#) on page 3-26.



## ***Eliminating Repetitive Scanning***

To eliminate repetitive scanning of identical items, you can enter a quantity prior to scanning a bar code. This quantity entry feature can also be used when manually entering bar code data.

To enter a quantity, press the \* key. The following screen with a default value of “1” will appear:

Quantity:  
1^\_\_\_\_\_

To enter the value you desire, key in the quantity followed by the <ENTER> key. Next, the bar code data entry screen reappears. Scan the item’s bar code. The scanner sends the bar code data to the host the keyed-in amount of times. For instance, if you type in a quantity of 6 then scan a bar code, the scanner sends that bar code data to the host six times as if the bar code had been scanned six times.

If you have accidentally entered this screen, it will automatically be exited after 5 seconds or by pressing the <ENTER> key without entering a quantity.

## Communication Errors

---

A communication error occurs when the scanner, cradle or host fails to properly communicate. When a communication error occurs using the default application, the scanner emits 4 beeps (LO HI LO HI) and displays a "Failed Communication" error message, like the one shown below. The three-digit error code on the scanner screen indicates what type of communication problem occurred. Error code 015 generally indicates the scanner is out of RF range, not properly paired to the base, or the base may have lost power. For a detailed list of all the error codes see [Appendix D, Messages and Error Codes](#) and [Beeper Indications / Default Application Error Codes](#) on page 4-8.

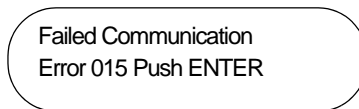

To return to the application, press <ENTER>.

Three types of communication errors can occur:

1. The RF transmitted data was NOT received by the cradle.
2. The cradle received the RF transmitted data, but the scanner did NOT receive a cradle's acknowledgment.
3. The host and cradle are not communicating properly.

### ***RF Communication Errors***

1. If the RF transmitted data was NOT received by the cradle, move the scanner closer to the cradle to reestablish communication, then re-scan the bar code. If the communication has been reestablished, the scanner will sound a good decode beep and no error beeps. Resume normal scanning.
2. If the cradle received the RF transmitted data, but the scanner did NOT receive a cradle's acknowledgment, move the scanner closer to the cradle to reestablish communication, then re-scan the bar code. If the communication has been reestablished, the scanner will sound a good decode beep and no error beeps. In this scenario data may have been transmitted to the host. If the cradle had previously sent data to the host, it will NOT pass this re-scanned data to the host. Resume normal scanning.

For additional information see [Optimizing RF Performance](#) on page 2-7.



## ***Host / Cradle Communication Errors***

3. If the host and cradle are not communicating properly, insure the cabling is properly connected, baud rate is properly set, and correct COM port has been selected.

## System Menu

---

The system menu allows the user to set up the operation of the scanner, such as loading a new application, set the scanner's RF channel, setting the scanner ID, etc.

Enter the System Menu by scanning the bar code below or by entering a keypad sequence.

---

**Note:** *Commonly used System Menu programming bar codes have been consolidated on page 1-4.*

---



**Enter System Menu Bar Code**

To access the System Menu using the keypad sequence, press the <FUNC>, then the <\*> key, followed by the <FUNC> key, then the <BK> key.

When you enter the system menu, the following screen appears:

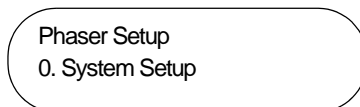

Below is the list of available options. Press the Up  $\Delta$  and Down  $\nabla$  arrow keys to scroll through them. Press <ENTER> to select a menu option. You can also select a menu option directly by typing the associated menu option number and then pressing <ENTER>.

- 0. System Setup
- 1. App. Control
- 2. Parameter Control
- 3. System Status
- 4. Version
- 9. Return to App.

The system menu options are described below.

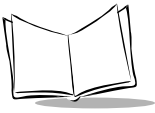

## System Setup Options

System Setup allows you to configure the scanner's basic settings such as setting an RF channel.

Option	Description
<b>0. Set Com Protocol</b> -RS232/Synapse -MCL NET -Back to Com Protocol	Sets the communication protocol used by the default application. The options are MCL-Net or RS232/Synapse. If RS232/Synapse is selected, the scanner automatically identifies whether an RS-232 or Synapse interface is required. To cancel the change, press the <FUNC> then <BK> keys, and to accept the change, press the <ENTER> key.
<b>1. Set RF Channel</b>	<p>Allows the user to set/change the RF channel used for communication between the scanner and cradle.</p> <p>The cordless Phaser scanner operates on a single, programmable channel (frequency) between 2.402 GHz (channel 02) and 2.483 GHz (channel 83).</p> <p>A maximum of 81 channels are available. Not all channels are available in all countries. If a channel is not legal to use in your country, an error beep will be heard instead of a successful warble. For a list of Channel Availability by Country, see <a href="#">Appendix C, Radio Channels</a>.</p> <div data-bbox="628 899 986 1019" style="border: 1px solid black; border-radius: 15px; padding: 10px; margin: 10px auto; width: fit-content;"><p>Channel:                    54 New Channel:             --</p></div> <p>To cancel the change, press the &lt;FUNC&gt; then &lt;BK&gt; keys, and to accept the change, press the &lt;ENTER&gt; key.</p>
<b>2. Set Contrast</b>	Sets the display contrast. The scanner displays the current contrast setting. Use the up and down arrow keys to change the contrast. The default contrast is 7, and the range is from 0 to 15, with 0 being the lightest and 15 being the darkest. To cancel the change, press the <FUNC> then <BK> keys, and to accept the change, press the <ENTER> key.
<b>3. Set Scanner ID</b>	Sets the scanner ID. The scanner displays its current ID, and the user may key in a new value between 1 and 254. The default is 001. To cancel the change, press the <FUNC> then <BK> keys, and to accept the change, press the <ENTER> key.
<b>9. Back to Main</b>	Returns the user to the system menu.





## App. Control

App. Control allows you to control your application, specifically, load new applications on your scanner, reset your default applications, etc.

You can load a new application or system code by either scanning the appropriate bar code or entering the appropriate keypad value as indicated on the display.

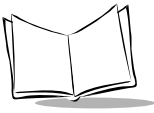
Option	Description
<p><b>0. Load App</b></p>	<p>Puts the scanner into a mode to receive MCL-Designer application downloads and MCL-Link commands from the host. To enter this mode using the key pad, select this option on the system menu. The following screen displays:</p> <div data-bbox="677 586 1035 686" style="border: 1px solid black; border-radius: 15px; padding: 10px; margin: 10px auto; width: fit-content;"> <p>Load New App. &lt;ENTER&gt;=YES &lt;BK&gt;=NO</p> </div> <p>OR</p> <p>To enter this mode from an application without entering the system menu or entering key strokes, scan the bar code below.</p> <div data-bbox="744 833 950 930" style="text-align: center;">  </div> <p style="text-align: center;"><b>Load New MCL-Designer Application</b></p> <div data-bbox="677 1024 1035 1125" style="border: 1px solid black; border-radius: 15px; padding: 10px; margin: 10px auto; width: fit-content;"> <p>Scanner ready, on PC start download</p> </div> <p>When this screen displays, the scanner is ready to accept the download. On the PC Utility, initiate the download. After downloading is complete, the system menu is exited and the application initiated.</p> <p>To exit this mode and prevent the download of a new application, press the &lt;FUNC&gt; then &lt;BK&gt; keys.</p>



Option	Description
<b>1. Set Default App</b>	<p>Reinstalls the default application and returns all parameters to their factory settings (values listed in <a href="#">Table 5-1</a>). The default application overwrites any MCL-Designer application and/or ADF rules. This option may be used to restore functionality to a scanner which has been loaded with a defective application.</p> <p>To enter this mode using the key pad, select this option on the system menu. Prior to resetting the default application, the user is prompted to confirm this operation:</p> <div data-bbox="628 500 989 604" style="border: 1px solid black; border-radius: 15px; padding: 10px; text-align: center;"><p>Reset Default App? &lt;ENTER&gt;=YES &lt;BK&gt;=NO</p></div> <p>Press the &lt;ENTER&gt; key to confirm the choice (Yes) or the &lt;BK&gt; key to cancel the choice (No).</p> <p>If you entered “Set Default App” from the System Menu, upon resetting the default application, you will return to the System Menu.</p> <p>OR</p> <p>To enter this mode from an application without entering the system menu or entering key strokes, scan the bar code below.</p> <div data-bbox="680 928 917 1010" style="text-align: center;"></div> <p style="text-align: center;"><b>Reset Default Application</b> <b>(Clears previously programmed ADF rules and/or MCL-Designer applications)</b></p> <p>If you entered the “Set Default App” mode using the bar code above, the default application will automatically be reset, the System Menu exited, and the application re-initiated.</p>

Option	Description
<p><b>2. Enable AutoLoad AutoLoad App.</b></p> <ul style="list-style-type: none"> <li>-Enable</li> <li>-Disable</li> </ul>	<p>Enables the automatic application download feature in the default application. This allows the user to remove the scanner from the box, pair it with the cradle, place the scanner in the cradle and automatically download a new application to the scanner.</p> <p>In order for this feature to operate properly, the cradle must be connected to a host running <i>MCL-Link</i>, and the user's host must be configured properly with specific files in specific locations (See Appendix A). If the user does not set up the host in the required manner, the scanner reverts to normal charging mode. This feature is enabled by default, but may be disabled by use of this System Menu item.</p> <p>Selecting <code>Enable</code> will enable this feature; <code>Disable</code> will disable this feature. To exit without changing this setting, press &lt;FUNC&gt; then &lt;BK&gt;.</p> <p>Note that "Enable AutoLoad" ONLY works with the default application and does not work with any MCL Designer generated applications.</p>

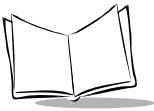

Option	Description
<b>3. System Code</b>	<p>Updates the scanner operating system (Firmware). To enter this mode using the key pad, select this option on the system menu.</p> <div data-bbox="632 321 989 423" style="border: 1px solid black; border-radius: 15px; padding: 10px; text-align: center;"><p>Load New System Code &lt;ENTER&gt;=YES &lt;BK&gt;=NO</p></div> <p>Press the &lt;ENTER&gt; key to confirm the choice (Yes) or the &lt;BK&gt; key to cancel the choice (No).</p> <p>OR</p> <p>To enter this mode from an application without entering the system menu or entering key strokes, scan the bar code below.</p> <div data-bbox="694 667 900 764" style="text-align: center;"></div> <p style="text-align: center;"><b>System Code</b></p> <div data-bbox="632 865 989 967" style="border: 1px solid black; border-radius: 15px; padding: 10px; text-align: center;"><p>Place unit in cradle on PC start download</p></div> <p>Place the scanner in the cradle before initiating the download from the PC Utility.</p> <p>After the download is complete, the system menu is exited and the application initiates.</p> <p>To exit this mode and prevent the download of new firmware, press and hold the &lt;ENTER&gt; key for 30 seconds. In addition, power to the cradle must be cycled (powered off then on) before it will communicate with the scanner again.</p>

Option	Description
<p><b>4. Base Station Code</b></p>	<p>Updates the cradle's operating system (Firmware). To enter this mode using the key pad, select this option on the system menu.</p> <div data-bbox="680 321 1038 423" style="border: 1px solid black; border-radius: 15px; padding: 10px; margin: 10px auto; width: fit-content;"> <p>Load New Base Code &lt;ENTER&gt;=YES &lt;BK&gt;=NO</p> </div> <p>Press the &lt;ENTER&gt; key to confirm the choice (Yes) or the &lt;BK&gt; key to cancel the choice (No).</p> <p><b>OR</b></p> <p>To enter this mode from an application without entering the system menu or entering key strokes, scan the bar code below.</p> <div data-bbox="731 667 963 756" style="text-align: center;">  </div> <p style="text-align: center;"><b>Base Station Code</b></p> <div data-bbox="680 865 1038 967" style="border: 1px solid black; border-radius: 15px; padding: 10px; margin: 10px auto; width: fit-content;"> <p>Base Station ready, on PC start download</p> </div> <p>To start the download to the cradle, press the start button on the PC Utility.</p> <p><b>Note:</b> You will automatically exit this message after 15 seconds and return to the application, even if the PC download is NOT initiated.</p> <p>To exit this mode and prevent the download of new firmware or if the PC download is not initiated, the power to the cradle must be cycled (powered off then on) before it will communicate with the scanner again. No action is required on the scanner side.</p>
<p><b>9. Back to Main</b></p>	<p>Returns the user to the system menu.</p>

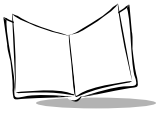

## Parameter Control

Parameter Control allows you to control the scanner parameters such as Scan Parameters and Set Default Params.

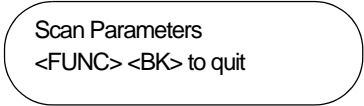
Option	Description
<b>0. Scan Parameters</b>	<p>This feature only works when used with an application generated with MCL-Designer and allows you to program your scanner by scanning the bar codes in <a href="#">Chapter 5, Parameter Menus</a>. Parameters already set in your MCL-Designer generated application can not be overridden by scanning bar codes. When you see the following screen, you can begin scanning parameter bar codes:</p> <div style="text-align: center;"></div> <p>After scanning the desired bar codes, press &lt;FUNC&gt; then &lt;BK&gt; to exit this mode.</p>
<b>1. Set Default Param</b>	Restores the default parameters in the scanner. The default parameters overwrite any scanned parameters. Prior to resetting the default parameters, you are prompted to confirm your choice.
<b>9. Back to Main</b>	Returns the user to the system menu.

## System Status

System Status allows you to perform system checks such as Battery Check.

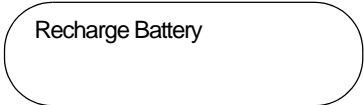
Option	Description
<b>0. Battery Check</b>	<p>Checks the battery charge level. Good indicates the battery does not require recharging. Low/Recharge indicates the scanner requires a recharge. When the battery is close to complete discharge, the following message displays:</p> <div style="text-align: center;"></div>
<b>9. Back to Main</b>	Returns the user to the system menu.

## Version

<b>0. Scanner Version</b>	<p>This option displays the version of firmware (operating system) run by the scanner. For example, the firmware version shown on the display below is NBRVRAAG, also called Revision "G" (which is the last letter of the firmware's full name NBRVRAAG).</p> <p>To enter this mode using the keypad, select this option on the System Menu. The following screen displays.</p> <div data-bbox="658 459 1016 581" style="border: 1px solid black; border-radius: 15px; padding: 10px; text-align: center;"><p>Scanner: NBRVRAAG MCL: 4.1</p></div> <p>If you entered "Scanner Version" from the System Menu, after 15 seconds or by pressing &lt;ENTER&gt;, you will return to the System Menu.</p> <p>OR</p> <p>To enter this mode from an application outside of the System Menu, scan the bar code below.</p> <div data-bbox="732 816 938 898" style="text-align: center;"></div> <p style="text-align: center;"><b>Scanner Firmware Version</b></p> <p>If you entered "Scanner Version" using the bar code above, after 15 seconds or by pressing &lt;ENTER&gt;, you will automatically exit the System Menu and re-enter the application.</p>
---------------------------	--



<b>1. Cradle Version</b>	<p>This option displays the version of firmware (operating system) run by the cordless scanner's cradle. For example, the firmware version shown on the display below is NBRVCAAF, also called Revision "F" (which is the last letter of the firmware's full name NBRVCAAF).</p> <p>To enter this mode using the keypad, select this option on the System Menu. The following screen displays.</p> <div data-bbox="610 440 968 565" style="border: 1px solid black; border-radius: 15px; padding: 10px; text-align: center; margin: 10px auto; width: fit-content;"><p>Cradle: NBRVCAAF</p></div> <p>If you entered "Cradle Version" from the System Menu, after 15 seconds or by pressing &lt;ENTER&gt;, you will return to the System Menu.</p> <p>OR</p> <p>To enter this mode from an application outside of the System Menu, scan the bar code below.</p> <div data-bbox="683 802 890 883" style="text-align: center;"></div> <p style="text-align: center;"><b>Cradle Firmware Version</b></p> <p>If you entered "Cradle Version" using the bar code above, after 15 seconds or by pressing &lt;ENTER&gt;, you will automatically exit the System Menu and re-enter the application.</p>
<b>9. Back to Main</b>	Returns the user to the system menu.

## Return to App

<b>Return to App.</b>	Return to App exits the system menu and returns to the application. To do this, press <9> then <ENTER>.
-----------------------	---



## 123Scan

---

123Scan is an intuitive Windows based utility that allows you to customize your scanner setup and generate Advanced Data Formatting (ADF) rules. An Advanced Data Formatting rule gives you the ability to modify the bar code data before sending it to the host such as appending a carriage return, or some other prefix/suffix value, to the bar code data. This enhances capability between bar code data and your host software, allowing you to program the scanner rather than modifying your host application. The cordless scanner can be programmed via a cordless (RF) download or by scanning 123Scan generated programming bar codes. Scanner programming is saved in a setup file which can be distributed electronically (Web site, floppy disk, E-mail, or fax).

A copy of 123Scan is on the CD included with your scanner. It is also available on the Symbol Web site <http://www.symbol.com>. Use the web site's search tool to find "123Scan" and select the P470/370 product line.

---

**Note:** *Advanced data formatting rules created with 123Scan are for use with the default application only and will not work with applications created with MCL-Designer.*

---

To download a 123Scan generated ADF rule, scan the bar code below, then initiate the download on the PC utility.



**Load 123Scan File**

To remove previously programmed ADF rules from the scanner, scan the bar code below.



**Reset Default Application  
(Clears previously programmed ADF rules)**

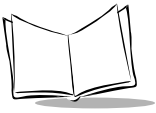

## Suffix Values

123Scan generated programming bar codes for two commonly used suffixes (Enter and Tab) have been included in this *Product Reference Guide*.

**To append an Enter key\*** to the transmitted bar code data, scan all nine (9) ADF rule bar codes and then the Reset Scanner bar code, in that order.

\* ASCII value 7013

---

**Note:** *You will get a successful decode beep after each barcode you scan. If you get an error beep (three beeps - Lo Hi Lo or two beeps - Lo Hi), you must start scanning from the first barcode.*

---

## ADF Rules

1/9

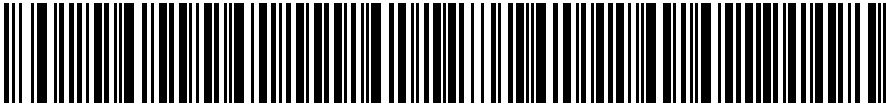

2/9

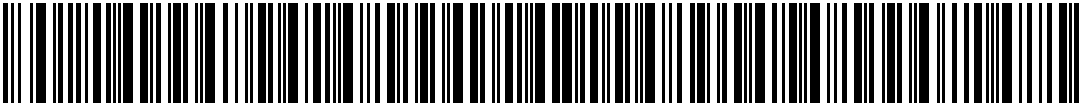

3/9

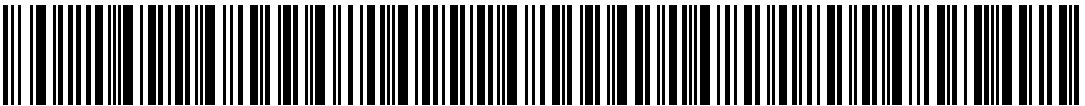

4/9

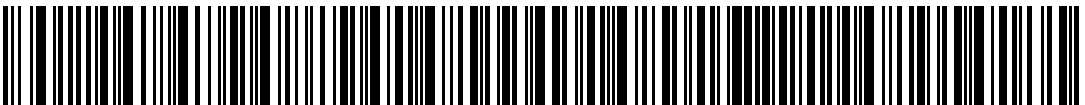

5/9



6/9



7/9



8/9



9/9



RESET SCANNER





To append a Tab\* to the transmitted bar code data, scan all nine (9) ADF rule bar codes and then the Reset Scanner bar code, in that order.

\*ASCII value 7009

---

**Note:** You will get a successful decode beep after each barcode you scan. If you get an error beep (three beeps - Lo Hi Lo or two beeps - Lo Hi), you must start scanning from the first barcode.

---

## ADF Rules

1/9

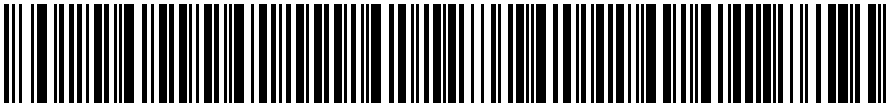

2/9

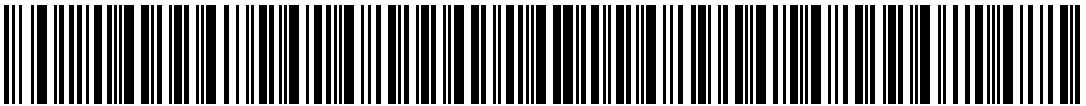

3/9

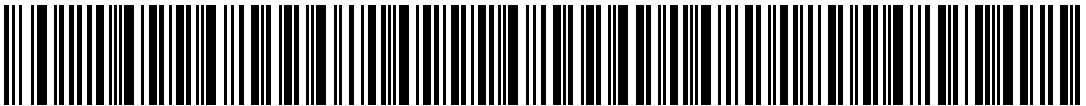

4/9



5/9

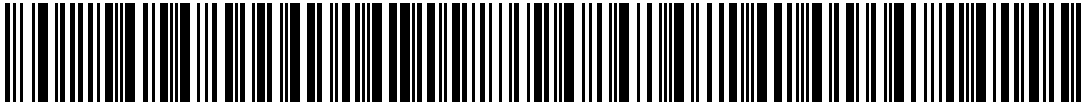

6/9

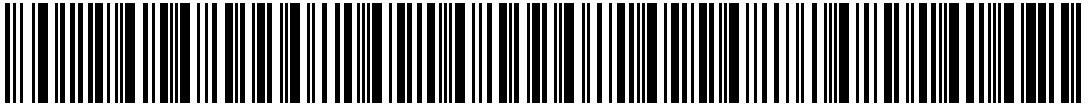

7/9

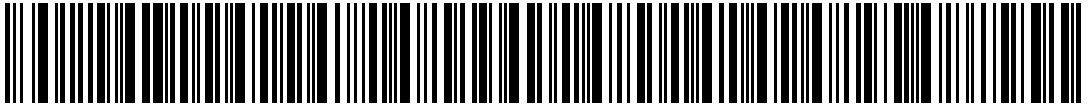

8/9

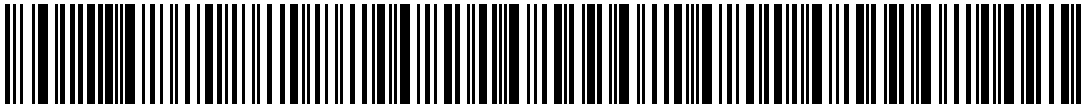

9/9

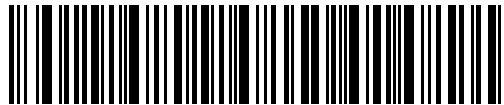

RESET SCANNER





## Scanning

---

The scanner ships with the default application and default parameters and is ready-to-use right out of the box. If this is not what you need for your application, refer to the *MCL Designer Manual* for programming instructions and [Chapter 5, Parameter Menus](#) for scanning and communications parameters. If you need assistance, contact your local supplier or Symbol Support Center.

1. Make sure the bar code is in the correct scanning range. Aim and press the trigger. The scanner has read the symbol when:
  - You hear a beep.
  - The LED above the screen turns green.
  - The red laser turns off.

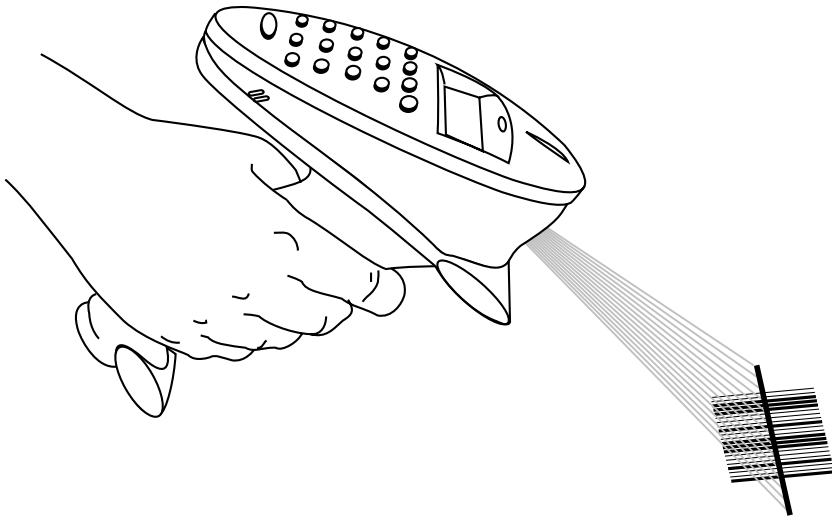

**Figure 3-1. Scanning a Bar Code**

### ***Scan the Entire Symbol***

- Your scan beam must cross every bar and space on the symbol.
- The larger the symbol, the farther away you should hold the scanner.
- Hold the scanner closer for symbols with bars that are close together.
- A short, high tone beep indicates a good decode.



### Hold at an Angle

Do not hold the scanner directly over the bar code. Laser light reflecting *directly* back into the scanner from the bar code is known as specular reflection. This strong light can “blind” the scanner and make decoding difficult. The area where specular reflection occurs is known as a “dead zone.”

You can tilt the scanner up to 65° forward or back and still achieve a successful decode. Simple practice quickly shows what tolerances to work within.

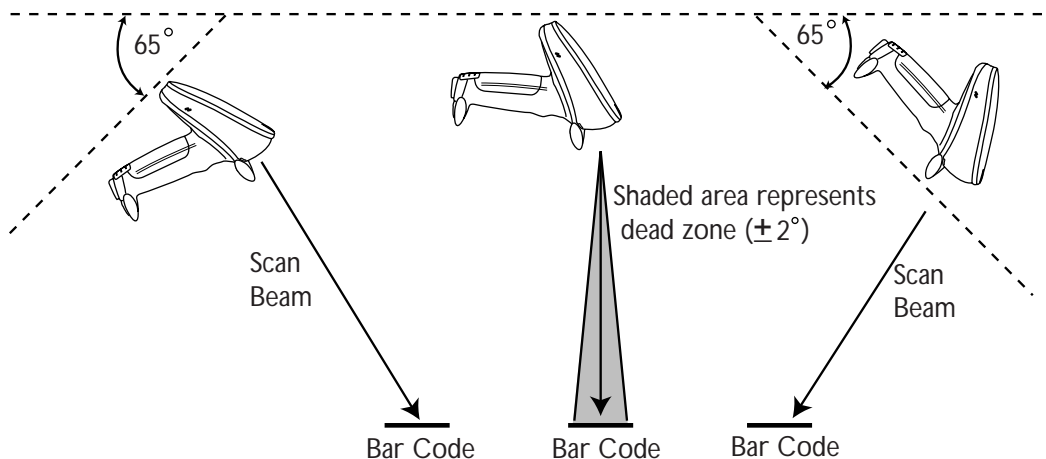

**Figure 3-2. Maximum Tilt Angles and Dead Zone**

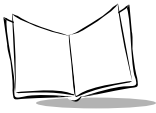

# Decode Zone

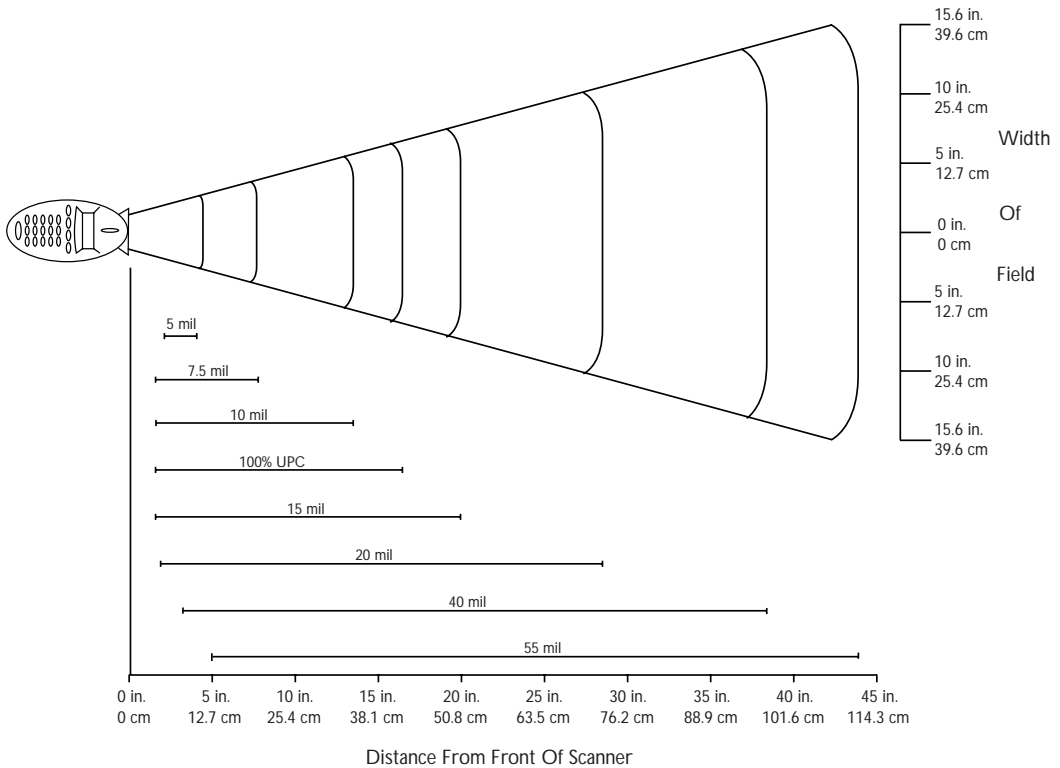
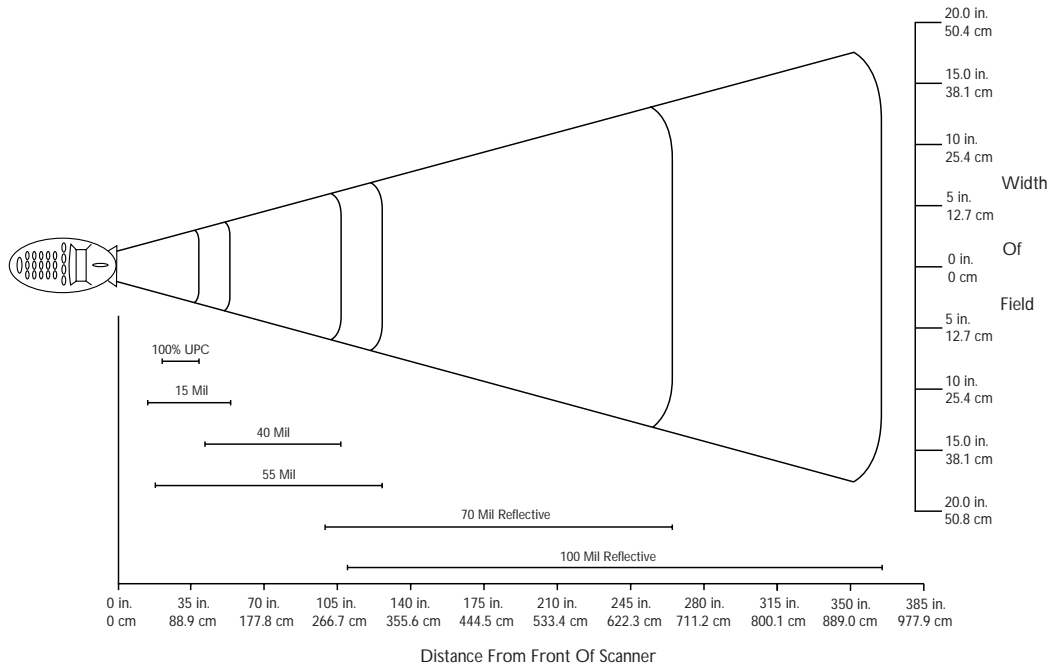
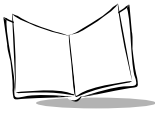

Figure 3-3. P470/P370 1D Scanner - Decode Zone





**Figure 3-4. P370 ALR Scanner - Decode Zone**



## Keypad Operation

---

Instead of scanning a bar code, you can enter the bar code data using the keypad on the top of the scanner. By default, this feature is enabled. To disable alphanumeric data entry via the keypad, go to the symbologies tab inside 123Scan and remove the “X” from the check box next to “Keypad”. (This does not disable the quantity entry feature discussed in [Eliminating Repetitive Scanning](#) on page 3-4.)

For additional information on 123Scan, see [123Scan](#) on page 3-17.

To enter numeric data, type the numeric value desired and press <ENTER>. A beep lets you know that the entry was accepted. See [Figure 3-5 on page 3-27](#).

To enter alpha characters, press the <Mode> key once to put the scanner in Alpha Mode.

Numeric buttons 1 through 9 are associated with the alpha characters. For example, the letters A, B and C are located on numeric button 7. Press the button with the letter you desire - once for the letter A, twice for the letter B, or three times for the letter C. You can continue entering alpha characters or switch to numerics. Press <ENTER> to save or send the data.

To return to numeric entry mode after entering alpha characters, press the <Mode> key again. For example, to manually enter **17ABF5**, do the following steps:

Data	Action
<b>1</b>	Press numeric button 1.
<b>7</b>	Press numeric button 7.
<b>A</b>	Press <MODE> button once, then numeric button 7 once. Wait for one second (you will hear a low pitched beep).
<b>B</b>	Press numeric button 7 twice.
<b>F</b>	Press numeric button 8 three times.
<b>5</b>	Press <MODE> button once, then numeric button 5 once, then <ENTER>.

Every time you press the button with the letter you desire, you hear a low-pitched beep to let you know that the entry was registered. Although the entry is registered, it has not been

transferred to the host yet. A high-pitched beep lets you know that the entry has been transferred to the host.

To return to numeric mode, press the Mode key again. Pressing the Enter key saves the data.

To put a decimal point (.) into numeric data, type in the numbers before the decimal point, then press the mode key, press the decimal, and press the mode key again. Now resume typing in the values to the right of the decimal.

To enter a dash (-), press the mode key once, then the zero (0) key twice.

To enter a blank space ( ), press the mode key once, then the zero (0) key three times.

The Function key in combination with a numeric key can be programmed to launch an operation. For more information on how to program these keys for additional tasks and operations, refer to the *MCL Designer User's Guide* p/n 70-37689-XX.

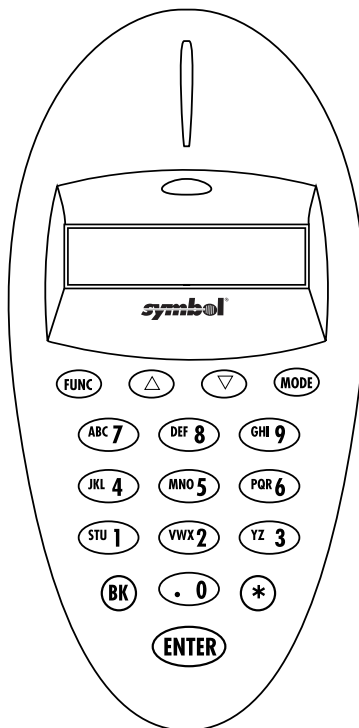

**Figure 3-5. Scanner Keypad**



*P470/370 RF Scanner Product Reference Guide*

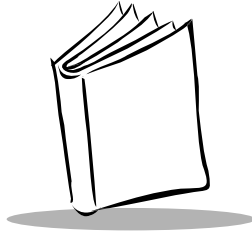

## *Chapter 4*

# *Maintenance And Specifications*

### **Introduction**

---

This chapter explains how to maintain your scanner and the specifications for it.

### **Maintenance**

---

- Do not allow any abrasive material to touch the scanner window.
- Remove any dirt particles with a damp cloth.
- Wipe the scanner window using a damp cloth, and if necessary, a non-ammonia based detergent.
- Do not spray water or other cleaning liquids directly into the scanner window.
- If the contacts between the scanner and cradle become dirty, clean them with either a pencil eraser or a cotton swab dampened with alcohol.
- If a significant decrease in battery life is noticed and does not correspond to increased usage, consider replacing the battery.

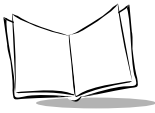

# Troubleshooting

Refer to [Appendix D, Messages and Error Codes](#) for additional troubleshooting information.

**Table 4-1. Troubleshooting Table**

<b>Problem</b>	<b>Possible Causes</b>	<b>Possible Solutions</b>
Scanner won't power up.	Battery not charged.	Charge or replace the battery in the scanner
	Battery not installed properly.	Ensure the battery is installed properly. See <a href="#">Changing the Battery</a> on page 2-10.
LED on base is always on.	Base is locked up	Cycle power (power off then on) to the base.
Nothing happens when you follow the operating instructions, or the scanner displays erratic behavior (laser does not come on, scanner emits frequent beeps).	No power to the scanner.	Check the system power. Ensure the power supply is connected, if your configuration requires a power supply.
	Interface/power cables are loose.	Check for loose cable connections at the cradle, AC power supply, or host device.
No laser beam when trigger is pressed.	Failed to download firmware.	Reset the scanner (hold down the ENTER key for about 30 seconds) and try scanning again.
	Scanner is locked up.	Reset the scanner (hold down the ENTER key for about 30 seconds) and try scanning again.
Laser comes on but the symbol does not decode.	Scanner is not programmed for the correct bar code type.	Ensure the scanner is programmed to read the type of barcode you are scanning.
	Bar code symbol is unreadable.	Check the symbol to ensure it is not defaced. Try scanning test symbols of the same bar code type.
	Distance between scanner and bar code is incorrect.	Move the scanner closer to or further away from the bar code.
Symbol decodes but data is not transmitted to the host.	Scanner is not programmed for the correct host type.	Scan the appropriate host type bar code.

**Table 4-1. Troubleshooting Table (Continued)**

<b>Problem</b>	<b>Possible Causes</b>	<b>Possible Solutions</b>
Scanned data is incorrectly displayed on the host.	Scanner is not programmed to work with the host.	Ensure the proper host type is selected. Check the scanner host type parameters or editing options: <ul style="list-style-type: none"> <li>For RS-232, ensure the scanner's communication parameters match the host's settings.</li> </ul>
The scanner emits error beeps after decoding a bar code.	Cradle is not powered up or cable connections are not secure.	Check that the cradle is powered up and that its cable connections are secure. See <a href="#">Setting Up the Cradle</a> on page 2-1.
	Scanner and cradle are not successfully paired.	Check that the scanner is successfully paired with the cradle. See <a href="#">Pairing the Scanner with the Cradle</a> on page 2-6.
	Scanner is too far from the base for proper transmission.	Move closer to the base and retransmit.
	Previously scanned data not transmitted to host.	Ensure you are within the proper RF transmission range.
Received a communication error beep while using a Synapse cable.	The cables connected to the cradle were not connected in the correct sequence.	Before power is applied to the cradle, the Synapse cable must be connected to the cradle <u>AND</u> the flying power lead plugged in. See <a href="#">Using A Synapse Cable</a> on page 2-3 for more information
The scanner does not scan the programming bar codes in this guide.	Bar code symbol is unreadable.	Check the symbol to ensure it is not defaced. Try scanning test symbols of the same bar code type.
	Distance between scanner and bar code is incorrect.	Move the scanner closer to or further away from the bar code.

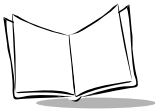

**Table 4-1. Troubleshooting Table (Continued)**

<b>Problem</b>	<b>Possible Causes</b>	<b>Possible Solutions</b>
The PC cannot download an application to the scanner.	Incorrect cable connection.	Check to ensure you are using an RS-232 cable. The application cannot be downloaded to a scanner using a Synapse cable.
	Scanner and cradle are not successfully paired.	Ensure the scanner and cradle are successfully paired.
	No power to the scanner.	Check to ensure the power supply is connected to the base. If the problem continues, cycle power to the base (power off then on).
The P370 ALR scanner will not pair with a PL370 cradle.	Incorrect set up for pairing scanner with the cradle.	To pair a long range P370 ALR scanner with a PL370 cradle, attach the spare pairing bar code label to the cradle and scan the bar code. For additional information, see <a href="#">Pairing the Scanner with the Cradle</a> on page 2-6.
The Scanner will not load my ADF rule.	Unsuccessful pairing of scanner with cradle or incorrect cable connection.	Software download to the scanner while the scanner is running the default application. <ul style="list-style-type: none"><li>• Check that the scanner is successfully paired with the cradle (see page 2-6).</li><li>• Check that the cradle and PC are connected using an RS-232 cable.</li></ul>
	The scanner is running an MCL-Designer generated application.	Software download or scanning a bar code sheet while the scanner is running an MCL-Designer generated application <ul style="list-style-type: none"><li>• Erase the MCL-Designer application from the scanner's memory by scanning the "Reset Default Application" bar code on page 3-17.</li><li>• The default application is now reinstalled and an ADF rule can be loaded.</li></ul>

---

**Note:** *If after performing these checks the symbol still does not scan, contact your distributor or call the Symbol Support Center. See [Symbol Support Center](#) on page [page xi](#) for the telephone number.*

---



## Technical Specifications

**Table 4-2. Technical Specifications**

Item	Description	
<b>Decode Capability</b>	The RF scanner can be programmed to decode the following code types: UPC/EAN, Bookland EAN, Code 11, Code 39, Code 39 Full ASCII, Trioptic Code 39, Code 93, Codabar, Interleaved 2 of 5, Code 128, EAN 128, Discrete 2 of 5, MSI Plessey, and Coupon Code. The RF scanner can auto-discriminate between all of the above code types except for Code 39 and Code 39 Full ASCII.	
<b>Scanner Beeper Operation</b>	User-selectable: Enabled, Disabled.	
<b>Scan Repetition Rate</b>	35 ( $\pm$ 5) scans/sec (bidirectional)	
<b>Roll (Skew) Tolerance</b>	$\pm$ 30° from normal	
<b>Pitch</b>	$\pm$ 65° from normal	
<b>Yaw</b>	$\pm$ 60° from normal	
<b>Decode Depth of Field</b>	See <a href="#">Decode Zone</a> on page 3-24.	
<b>Print Contrast Minimum</b>	20% absolute dark/light differential, measured at the wavelength of the laser diode.	
<b>Ambient Light Immunity</b>		
<b>Artificial Lighting</b>	450 ft. candles	4844 lux
<b>Sunlight</b>	10,000 ft. candles	107,640 lux
<b>Operating Temperature</b> P370 (Industrial) P470 (Retail)	-4° to 122°F 32° to 104°F	-20° to 50°C 0° to 40°C
<b>Storage Temperature</b>	-40° to 140°F	-40° to 60°C
<b>Sealing</b>	P370: All components sealed to IP 54 specification against wind blown dust and rain.	
<b>Humidity</b>	5% to 95% (non-condensing)	
<b>Durability (Scanner)</b> P370 (Industrial) P470 (Retail)	P370: 6-ft. (1.8 m) P470: 5-ft. (1.5 m) Drops to concrete over entire temperature range	



**Table 4-2. Technical Specifications (Continued)**

Item	Description
<b>Dimensions</b>	
<b>Height</b>	7.0 in. (17.8 cm)
<b>Width</b>	9.2 in. (13.5 cm)
<b>Depth</b>	3.5 in. (9.8 cm)
<b>Laser Classifications</b>	CDRH Class II, IEC Class 1, IEC Class 2

# Cradle Pin-outs

The following table shows the pin-outs for COM1 on the cradle.

**Table 4-3. Pin-outs**

Pin	Cradle
1	Reserved
2	VCC (Out)
3	Ground
4	Synapse Data
5	Synapse Clock
6	RXD IN
7	TXD OUT
8	DTR (Tied HI)
9	CTS - IN
10	RTS - OUT

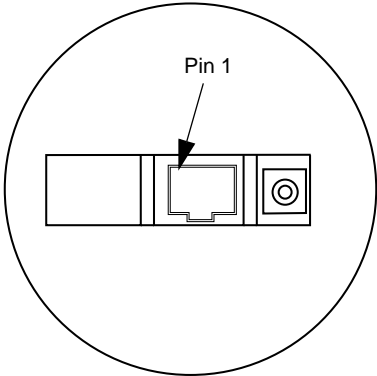

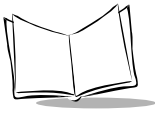

## Beeper Indications / Default Application Error Codes

Table 4-4 list beep sequence and their meanings for standard beeps programmed into the scanner. Other applications written for the scanner can have their own beep sequences and therefore are not listed in this table. See your System Administrator for beep sequences and their meanings.

For additional information on Error Codes, see [Communication Errors](#) on page 3-5.

**Table 4-4. Beeper Indications**

Beeper Sequence	Indication	Default Application Error Codes
<b>Standard Use</b>		
<b>Short high tone</b>	A bar code symbol was decoded (if decode beeper is enabled).	N/A
<b>4 Beeps - long low</b>	A host transmission error occurred. Data was not successfully sent to the host device. This occurs if a unit is not properly configured. Check option settings.	Error code 003 Error code 009 Error code 018 Error code 247 Error code 249 Error code 253
<b>5 Beeps - low tone</b>	Convert or format error.	Error code 002 Error code 008
<b>Hi/Hi/Hi/Lo tone</b>	RS-232 receive error.	Error code 005
<b>4 Beeps - short Hi</b>	Battery requires recharging.	Low Battery
<b>4 Beeps - Lo/Hi/Lo/Hi</b>	An RF transmission error has occurred. Move closer to the cradle and re-scan the bar code.	Error code 015 Error code 016 Error code 017 Error code 024
<b>Parameter Menu Scanning</b>		
<b>Short high tone</b>	Correct entry scanned or correct menu sequence performed.	N/A

**Table 4-4. Beeper Indications (Continued)**

<b>Beeper Sequence</b>	<b>Indication</b>	<b>Default Application Error Codes</b>
<b>Long Lo/Long Hi tone</b>	Input error, incorrect bar code or "Cancel" scanned, wrong entry, incorrect bar code programming sequence; remain in program mode.	N/A
<b>Hi/Lo tone</b>	Keyboard parameter selected. Enter value using bar code keypad.	N/A
<b>Hi/Lo/Hi/Lo tone</b>	Successful program exit with change in the parameter setting.	N/A
<b>4 Beeps - Lo/Hi/Lo/Hi followed by 2 Beeps - Lo/Hi</b>	Correct entry scanned or correct menu sequence performed in the scanner but communication error with cradle has occurred.	N/A

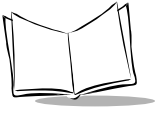

*P470/370 RF Scanner Product Reference Guide*

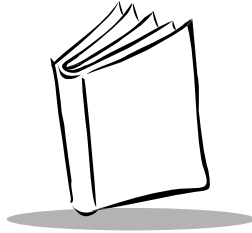

# Chapter 5

## Parameter Menus

### Introduction

---

This chapter has the optional parameter bar codes necessary to program the RF scanner.

### Operational Parameters

---

The RF scanner is shipped with the settings shown in [Table 5-1](#). These default values are stored in non-volatile memory and are preserved even when the scanner is powered down. You can change these default values by scanning the appropriate bar codes included in this manual. These new values replace the standard default values in memory. The default parameter values can be recalled by scanning the bar code in the section [Set Default Parameter](#) on page 5-7.

The scanner automatically detects which cable it is attached to, either an RS-232 or a Synapse cable. If it is attached to an RS-232 cable and has either an ICL, Nixdorf, or Fujitsu host interface, then scan the appropriate bar code from page [5-10](#) after power up. Any other RS-232 host interface works with the default setting.

If it is attached to a Synapse cable, plug everything together as described on page [2-3](#) and then follow the directions that come with the Synapse cable for setting up the host interface.

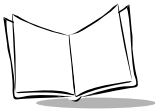

The following table lists the defaults for all parameters. If you wish to change any option, scan the appropriate bar code(s). An asterisk (\*) next to a bar code indicates the default.

**Table 5-1. Default Table**

Parameter	Default	Page Number
Set Default Parameter	All Defaults	5-7
<b>Communication Protocol</b>		
Scan & Transmit Application	RS232/Synapse	5-8
RS-232 Host Type	Standard	5-9
Host Response Timeout	5 seconds	5-12
RF Channel	No Default Setting	5-13
RF Retries	4	5-13
Sleep Time	10 seconds	5-15
Decimal Separator	Decimal Point (.)	5-16
Key Click	Enabled	5-17
<b>Beeper Options</b>		
Beeper Tone	High Frequency	5-18
Beeper Volume	High	5-19
Power Detect Beep	Enabled	5-20
Beep After Good Decode	Enabled	5-21
Laser On Time	3.0 seconds	5-22
<b>Decode Options</b>		
Transmit "No Read" Message	Disabled	5-23
Linear Code Type Security Levels	1	5-24
Bi-directional Redundancy	Disabled	5-26
Autodiscriminate Response Time	1.0 second	5-27



Table 5-1. Default Table (Continued)

Parameter	Default	Page Number
<b>UPC/EAN</b>		
UPC-A	Enabled	<a href="#">5-28</a>
UPC-E	Enabled	<a href="#">5-28</a>
UPC-E1	Disabled	<a href="#">5-28</a>
EAN-8	Enabled	<a href="#">5-29</a>
EAN-13	Enabled	<a href="#">5-29</a>
Bookland EAN	Disabled	<a href="#">5-30</a>
Decode UPC/EAN Supplementals	Ignore	<a href="#">5-31</a>
Decode UPC/EAN Supplemental Redundancy	7	<a href="#">5-32</a>
Transmit UPC-A Check Digit	Enabled	<a href="#">5-33</a>
Transmit UPC-E Check Digit	Enabled	<a href="#">5-33</a>
Transmit UPC-E1 Check Digit	Enabled	<a href="#">5-33</a>
UPC-A Preamble	System Character	<a href="#">5-34</a>
UPC-E Preamble	System Character	<a href="#">5-35</a>
UPC-E1 Preamble	System Character	<a href="#">5-36</a>
Convert UPC-E to A	Disabled	<a href="#">5-37</a>
Convert UPC-E1 to A	Disabled	<a href="#">5-38</a>
EAN-8 Zero Extend	Disabled	<a href="#">5-39</a>
Convert EAN-8 to EAN-13 Type	Type is EAN-13	<a href="#">5-40</a>
UPC/EAN Security Levels	0	<a href="#">5-41</a>
UPC/EAN Coupon Code	Disabled	<a href="#">5-43</a>

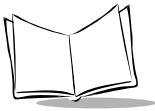
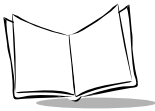

**Table 5-1. Default Table (Continued)**

Parameter	Default	Page Number
<b>Code 128</b>		
Code 128	Enabled	5-44
UCC/EAN-128	Enabled	5-45
ISBT-128	Enabled	5-47
<b>Code 39</b>		
Code 39	Enabled	5-48
Trioptic Code 39	Disabled	5-49
Set Length(s) for Code 39	2 to 55	5-51
Code 39 Check Digit Verification	Disabled	5-52
Transmit Code 39 Check Digit	Disabled	5-53
Code 39 Full ASCII Conversion	Disabled	5-54
Convert Code 39 to Code 32	Disabled	5-55
Code 32 Prefix	Disabled	5-56
<b>Code 93</b>		
Code 93	Disabled	5-57
Set Length(s) for Code 93	4-55	5-58
<b>Interleaved 2 of 5</b>		
Interleaved 2 of 5	Enabled	5-60
Set Length(s) for I 2 of 5	14	5-61
I 2 of 5 Check Digit Verification	Disabled	5-63
Transmit I 2 of 5 Check Digit	Disabled	5-64

**Table 5-1. Default Table (Continued)**

<b>Parameter</b>	<b>Default</b>	<b>Page Number</b>
Convert I 2 of 5 to EAN 13	Disabled	<a href="#">5-65</a>
<b>Discrete 2 of 5</b>		
Discrete 2 of 5	Disabled	<a href="#">5-66</a>
Set Length(s) for D 2 of 5	12	<a href="#">5-67</a>
<b>Codabar</b>		
Codabar	Disabled	<a href="#">5-69</a>
Set Lengths for Codabar	5-55	<a href="#">5-71</a>
CLSI Editing	Disabled	<a href="#">5-72</a>
NOTIS Editing	Disabled	<a href="#">5-73</a>
<b>MSI Plessey</b>		
MSI Plessey	Disabled	<a href="#">5-74</a>
Set Length(s) for MSI Plessey	Any Length	<a href="#">5-76</a>
MSI Plessey Check Digits	One	<a href="#">5-77</a>
Transmit MSI Plessey Check Digit	Disabled	<a href="#">5-78</a>
MSI Plessey Check Digit Algorithm	Mod 10/Mod 10	<a href="#">5-79</a>
<b>Data Options</b>		
Transmit Code ID Character	None	<a href="#">5-81</a>



**Table 5-1. Default Table (Continued)**

Parameter	Default	Page Number
<b>RS-232C</b>		
RS-232 Parameters	Standard	<a href="#">5-83</a>
Baud Rate	9600	<a href="#">5-84</a>
Parity	None	<a href="#">5-85</a>
Check Receive Errors	Disabled	<a href="#">5-87</a>
Hardware Handshaking	None	<a href="#">5-89</a>
Software Handshaking	None	<a href="#">5-91</a>
Host Serial Response Time-out	2 Sec.	<a href="#">5-94</a>
RTS Line State (cable use only)	Low	<a href="#">5-94</a>
Stop Bit Select	1	<a href="#">5-95</a>
ASCII Format	8-Bit	<a href="#">5-96</a>
Intercharacter Delay	0	<a href="#">5-96</a>
<b>MCL-Net</b>		
MCL-Net Baud Rate	38400	<a href="#">5-97</a>
MCL-Net Hex Addressing Mode	Disabled	<a href="#">5-99</a>
Scanner Address	001	<a href="#">5-100</a>
MCL-Net Transmit Retries	3	<a href="#">5-100</a>
MCL-Net Frame Timeout	500 ms	<a href="#">5-100</a>
Scanner Decode Beep Type	1	<a href="#">5-101</a>
<b>Long Range Scanning Bar Codes</b>		
Aim Mode	Sequential trigger/Aim	<a href="#">5-102</a>
Aim Duration	0.8 Sec	<a href="#">5-103</a>

## Set Default Parameter

---

Scanning this bar code returns all parameters to the values listed in [Table 5-1](#) (factory settings), but does not erase any programmed ADF rules.

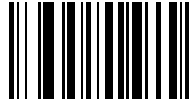

**SET ALL DEFAULTS**



## Communication Protocol

---

The bar codes below set the communication protocol used by the Scan & Transmit default application.

The communication options are RS232/Synapse or MCL-Net. If you select RS232/Synapse, the scanner automatically identifies whether an RS232 or Synapse interface is required. MCL-Net allows the scanner to communicate with a host running MCL-Link or MCL-Link Lite.

### ***Scan & Transmit Application***

This communication protocol is used for the real time scanning and transmission of data to a host when a cable is attached to the cradle.



**\*RS232/SYNAPSE**



**MCL-NET**

---

**Note:** *These communication protocol parameters only work with the default applications and will not work with applications created with MCL-Designer*

---

## Host Type

---

### RS-232C Host Types

Most RS-232C hosts work fine with the default settings, however, three RS-232C hosts are set up with their own parameter default settings. Selecting the ICL, Fujitsu or Nixdorf RS-232C host interface sets the defaults listed below. These defaults take precedence over Standard RS-232 defaults. So, if you select the Fujitsu RS-232C first, and then select the Standard RS-232 defaults, the Fujitsu defaults still take precedence. To return to the factory set defaults, scan the **SET ALL DEFAULTS** bar code on page 5-7.

**Table 5-2. Terminal Specific RS-232C**

Parameter	Standard	ICL	FUJITSU	NIXDORF Mode A/ Mode B
<b>Transmit Code ID</b>	No	Yes	Yes	Yes
<b>Data Transmission Format</b>	Data as is	Data/Suffix	Data/Suffix	Data/Suffix
<b>Suffix</b>	CR/LF	CR	CR	CR
<b>Baud Rate</b>	9600	9600	9600	9600
<b>Parity</b>	None	Even	None	Odd
<b>Hardware Handshaking</b>	None	RTS/CTS Option 3	None	RTS/CTS Option 3
<b>Software Handshaking</b>	None	None	None	None
<b>Serial Response Time-out</b>	2 Sec.	9.9 Sec.	2 Sec.	9.9 Sec.
<b>Stop Bit Select</b>	One	One	One	One
<b>ASCII Format</b>	8-Bit	8-Bit	8-Bit	8-Bit
<b>Beep On &lt;BEL&gt;</b>	Disabled	Disabled	Disabled	Disabled
<b>RTS Line State</b>	Low	High	Low	*Low = No data to send

\*In the Nixdorf Mode B, if CTS is Low, transmission of scan data is disabled. When CTS is High, bar code data is transmitted to the host.

\*\*If Nixdorf Mode B is scanned without the scanner connected to the proper host, it may appear unable to scan. If this happens, scan a different RS-232 host type within 5 seconds of cycling power to the scanner.



Scan the appropriate bar code below to select an RS-232C Host Interface.



**\*STANDARD RS-232C**



**ICL RS-232C**



**NIXDORF RS-232C Mode A**



**NIXDORF RS-232C Mode B**



**FUJITSU RS-232C**



**OPOS**



## Code ID Characters for RS232C Host Types

Selecting the ICL, Fujitsu, or Nixdorf RS-232C host interface enables the transmission of Code ID Characters as listed below. These Code ID Characters are not programmable and are separate from the Transmit Code ID feature. The Transmit Code ID feature should not be enabled for these hosts.

**Table 5-3. Terminal Specific Code ID Characters**

	ICL	FUJITSU	NIXDORF
<b>UPC-A</b>	"A"	"A"	"A"
<b>UPC-E</b>	"E"	"E"	"C0"
<b>EAN-8</b>	"FF"	"FF"	"B"
<b>EAN-13</b>	"F"	"F"	"A"
<b>Code 39</b>	"C" <len>	None	"M"
<b>Codabar</b>	"N" <len>	None	"N"
<b>Code 128</b>	"L" <len>	None	"K"
<b>I 2 of 5</b>	"I" <len>	None	"I"
<b>Code 93</b>	None	None	"L"
<b>D 2 of 5</b>	"H" <len>	None	"H"
<b>UCC/EAN 128</b>	"L" <len>	None	"P"
<b>MSI/Plessey</b>	None	None	"O"
<b>Bookland EAN</b>	"F"	"F"	"A"
<b>Unlisted Code Types</b>	None	None	None



## Host Response Timeout

---

This parameter indicates how long the scanner will wait for a response from the cradle, after the cradle has sent its data to the attached host device. The timeout ranges from 5 seconds to 64 seconds, in 1 second increments. The default is 5 seconds. To change the timeout value, scan the bar code below, then scan two bar codes using the [Numeric Bar Codes](#) on page 5-104.



**HOST RESPONSE TIMEOUT (RANGE OF 5 TO 64 SECONDS)**

## RF Channel

---

Selects the RF channel used for radio transmissions and reception. The channel ranges are nation dependent (see [Appendix C, Radio Channels](#) for a list of Channel Availability by Country). To enter a range, scan the bar code below followed by 2 digits from the numeric bar code section (starting on page [5-104](#)) to set the desired channel. If the channel is not legal for your country, an error beep will be heard instead of a successful warble. It is recommended that each scanner/cradle pair be set to a different channel than neighboring scanner/cradle pairs.

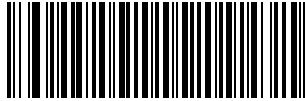

RF Channel

## RF Retries

---

On a transmission, the radio will try to send the data a certain number of times prior to giving up if the receiving cradle is not responding. The following parameter allows the user to select how many retries should be tried. For additional information, see [Increase the number of RF Retries](#) on page 2-8.

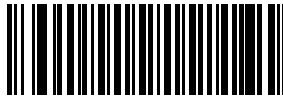

3 RETRIES



\*4 RETRIES

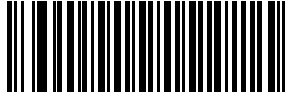
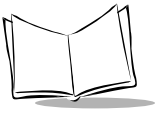

**5 RETRIES**

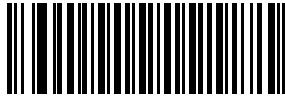

**6 RETRIES**

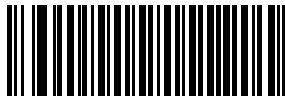

**7 RETRIES**

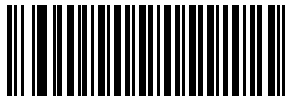

**8 RETRIES**

## Sleep Time

---

Scan the bar code below to select how long the scanner will “stay awake” (not power down) in seconds after a trigger pull or a key press. First scan this bar code, then enter a range from 05 to 32, using the [Numeric Bar Codes](#) on page 5-104. It can stay awake from 5 seconds to 32 seconds.

---

**Note:** *Allowing the scanner to stay awake longer than originally programmed may affect the battery life time for that session before needing a charge.*

---



**SLEEP TIME (RANGE OF 5 TO 32 SECONDS)**



## **Decimal Separator**

---

Scan the appropriate bar code below to select what separator to display when you hit the decimal point key on the keypad. Choose DECIMAL POINT (.) or COMMA (,).



**\*DECIMAL POINT (.)**



**COMMA (,)**

## Key Click

---

Scan the appropriate bar code below to select whether the keypad click is enabled or not. Choose ENABLE or DISABLE.



**\*ENABLE**



**DISABLE**



## Beeper Tone

---

Scan the appropriate bar code below to select a decode beep frequency (tone). Choose LOW FREQUENCY, MEDIUM FREQUENCY, or HIGH FREQUENCY.

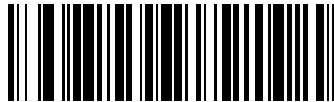

**LOW FREQUENCY**

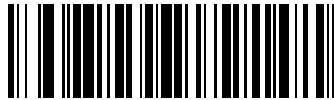

**MEDIUM FREQUENCY**

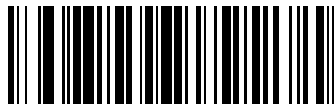

**\*HIGH FREQUENCY**



## Beeper Volume

---

Scan the appropriate bar code below to select a beeper volume. Choose LOW VOLUME, MEDIUM VOLUME, or HIGH VOLUME.



**LOW VOLUME**



**MEDIUM VOLUME**



**\*HIGH VOLUME**



## **Power Detect Beep**

---

Scan the appropriate barcode below to enable or disable the Power Detection Beep.



**POWER DETECT BEEP DISABLED**



**\*POWER DETECT BEEP ENABLED**

## Beep After Good Decode

---

Scan the appropriate bar code below to select whether or not the scanner beeps after a good decode. If DO NOT BEEP is selected, the beeper still operates during parameter menu scanning and indicates error conditions.



**\*BEEP AFTER GOOD DECODE**



**DO NOT BEEP AFTER GOOD DECODE**



## Laser On Time

---

This parameter sets the maximum time decode processing continues during a scan attempt. It is programmable in 0.1 second increments from 0.5 to 9.9 seconds.

Scan the bar code below to set a Laser On Time. Next scan two numeric bar codes beginning on page [5-104](#) that correspond to the desired time. Time less than 1.0 second must have a leading zero. For example, to set a Time On of 0.5 seconds, scan the bar code below, then scan the “0” and “5” bar codes. If you make an error, or wish to change your selection, scan [CANCEL](#) on page 5-106.

---

**Note:** *Allowing the scanner to stay on longer than originally programmed may affect the battery life time for that session before needing a charge.*

---



LASER ON TIME

## Transmit “No Read” Message

---

Scan the appropriate bar code below to select whether or not a “No Read” message is transmitted. When enabled, if a symbol does not decode, “NR” is transmitted. When disabled, if a symbol does not read, nothing is sent to the host.



**ENABLE NO READ**



**\*DISABLE NO READ**



## Linear Code Type Security Level

---

The scanner offers four levels of decode security for linear code types (e.g., Code 39, Interleaved 2 of 5). Higher security levels are selected for decreasing levels of bar code quality. As security levels increase, the scanner's aggressiveness decreases.

Select the security level appropriate for your bar code quality.

---

**Note:** Does not apply to Code 128.

---

### ***Linear Security Level 1***

The following code types must be successfully read twice before being decoded:

Code Type	Length
Codabar	All
MSI Plessey	4 or less
D 2 of 5	8 or less
I 2 of 5	8 or less



**\*LINEAR SECURITY LEVEL 1**

### ***Linear Security Level 2***

All code types must be successfully read twice before being decoded.

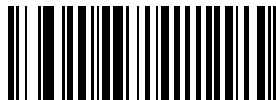

**LINEAR SECURITY LEVEL 2**

## Linear Code Type Security Level (Continued)

---

### ***Linear Security Level 3***

Code types other than the following must be successfully read twice before being decoded. The following codes must be read three times:

<b>Code Type</b>	<b>Length</b>
MSI Plessey	4 or less
D 2 of 5	8 or less
I 2 of 5	8 or less

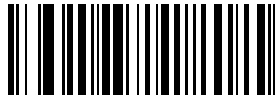

**LINEAR SECURITY LEVEL 3**

### ***Linear Security Level 4***

All code types must be successfully read three times before being decoded.

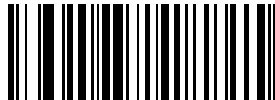

**LINEAR SECURITY LEVEL 4**



## Bi-directional Redundancy

---

This parameter is only valid when a **Linear Code Type Security Level** (see page [5-24](#)) is enabled. When this parameter is enabled, a bar code must be successfully scanned in both directions (forward and reverse) before being decoded.



**ENABLE BI-DIRECTIONAL REDUNDANCY**



**\*DISABLE BI-DIRECTIONAL REDUNDANCY**



## Autodiscriminate Response Time

---

This parameter extends the length of time during which the scanner tries to detect which host it is connected to on power up.

---

**Note:** *When connected to an LS 5700/5800 scanner, the 5 second option must be used.*

---



**\*1 second**



**5 seconds**



## Enable/Disable UPC-E/UPC-A/UPC-E1

---

Scan the appropriate bar code below to enable or disable UPC-E or UPC-A.

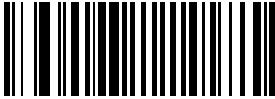

**\*ENABLE UPC-E**

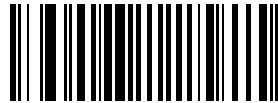

**DISABLE UPC-E**

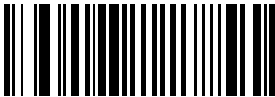

**\*ENABLE UPC-A**

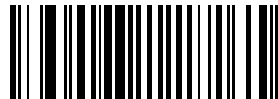

**DISABLE UPC-A**



**ENABLE UPC-E1**



**DISABLE UPC-E**

## Enable/Disable EAN-8/EAN-13

---

Scan the appropriate bar code below to enable or disable EAN-8 or EAN-13.

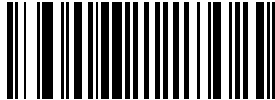

**\*ENABLE EAN-8**



**DISABLE EAN-8**

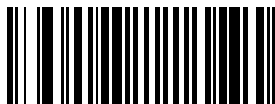

**\*ENABLE EAN-13**

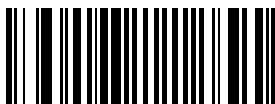

**DISABLE EAN-13**



## **Enable/Disable Bookland EAN**

---

Scan the appropriate bar code below to enable or disable Bookland EAN.



**ENABLE BOOKLAND EAN**



**\*DISABLE BOOKLAND EAN**

## Decode UPC/EAN Supplementals

---

Supplementals are characters (either 2 or 5) that are added on according to specific code format conventions (e.g., UPC A+2, UPC E+2, EAN 8+2). Three options are available.

- If **Decode UPC/EAN with supplementals** is selected, UPC/EAN symbols without supplemental characters are not decoded.
- If **Ignore UPC/EAN with supplementals** is selected, UPC/EAN symbols with supplemental characters are decoded and the supplemental characters are ignored.
- If **Autodiscriminate UPC/EAN supplementals** is selected, UPC/EAN symbols, either with or without supplementals, are decoded. If selected, choose an appropriate [Decode UPC/EAN Supplemental Redundancy](#) value from the next page.

---

**Note:** *To minimize the risk of invalid data transmission, select whether to read or ignore supplemental characters.*

---

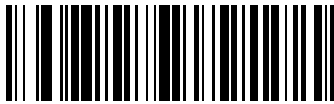

**DECODE UPC/EAN WITH SUPPLEMENTALS**

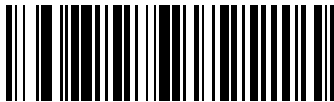

**\*IGNORE UPC/EAN WITH SUPPLEMENTALS**



**AUTODISCRIMINATE UPC/EAN SUPPLEMENTALS**



## Decode UPC/EAN Supplemental Redundancy

---

With Autodiscriminate UPC/EAN Supplementals selected, this option adjusts the number of times a symbol without supplementals is decoded before transmission. The range is from two to 20 times. Five or above is recommended when decoding a mix of UPC/EAN symbols with and without supplementals, and the autodiscriminate option is selected.

Scan the bar code below to select a decode redundancy value. Next scan two numeric bar codes beginning on page [5-104](#). Single digit numbers must have a leading zero. If you make an error, or wish to change your selection, scan [CANCEL](#) on page 5-106.

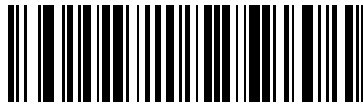

**DECODE UPC/EAN  
SUPPLEMENTAL REDUNDANCY**

## Transmit UPC-A/UPC-E/UPC-E1 Check Digit

---

Scan the appropriate bar code below to transmit the symbol with or without the UPC-A, UPC-E, or UPC-E1 check digit.

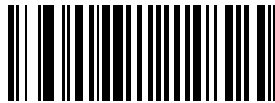

**\*TRANSMIT UPC-A CHECK DIGIT**

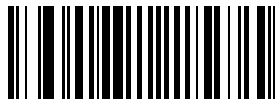

**DO NOT TRANSMIT UPC-A CHECK DIGIT**

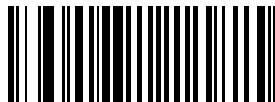

**\*TRANSMIT UPC-E CHECK DIGIT**

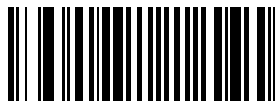

**DO NOT TRANSMIT UPC-E CHECK DIGIT**



**\*TRANSMIT UPC-E1 CHECK DIGIT**



**DO NOT TRANSMIT UPC-E1 CHECK DIGIT**



## UPC-A Preamble

---

Three options are given for lead-in characters for UPC-A symbols transmitted to the host device: transmit system character only, transmit system character and country code ("0" for USA), and no preamble transmitted. The lead-in characters are considered part of the symbol.



**NO PREAMBLE**  
(<DATA>)

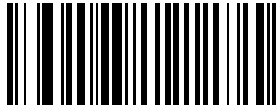

**\*SYSTEM CHARACTER**  
(<SYSTEM CHARACTER> <DATA>)



**SYSTEM CHARACTER & COUNTRY CODE**  
(< COUNTRY CODE> <SYSTEM CHARACTER> <DATA>)



## UPC-E Preamble

---

Three options are given for lead-in characters for UPC-E symbols transmitted to the host device: Transmit system character only, transmit system character and country code ("0" for USA), and no preamble transmitted. The lead-in characters are considered part of the symbol.

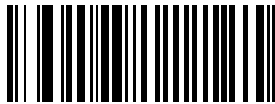

**NO PREAMBLE**  
(<DATA>)

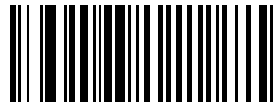

**\*SYSTEM CHARACTER**  
(<SYSTEM CHARACTER> <DATA>)



**SYSTEM CHARACTER & COUNTRY CODE**  
(< COUNTRY CODE> <SYSTEM CHARACTER> <DATA>)



## UPC-E1 Preamble

---

Three options are given for lead-in characters for UPC-E1 symbols transmitted to the host device: Transmit system character only, transmit system character and country code ("0" for USA), and no preamble transmitted. The lead-in characters are considered part of the symbol.



**NO PREAMBLE**  
(<DATA>)



**\*SYSTEM CHARACTER**  
(<SYSTEM CHARACTER> <DATA>)



**SYSTEM CHARACTER & COUNTRY CODE**  
(< COUNTRY CODE> <SYSTEM CHARACTER> <DATA>)

## Convert UPC-E to UPC-A

---

This parameter converts UPC-E (zero suppressed) decoded data to UPC-A format before transmission. After conversion, data follows UPC-A format and is affected by UPC-A programming selections (e.g., Preamble, Check Digit).

Scanning **DO NOT CONVERT UPC-E TO UPC-A** allows you to transmit UPC-E (zero suppressed) decoded data.

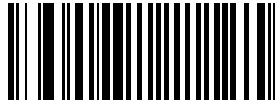

**CONVERT UPC-E TO UPC-A  
(ENABLE)**

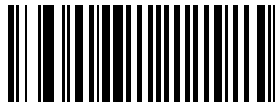

**\*DO NOT CONVERT UPC-E TO UPC-A  
(DISABLE)**



## Convert UPC-E1 to UPC-A

---

This parameter converts UPC-E1 decoded data to UPC-A format before transmission. After conversion, data follows UPC-A format and is affected by UPC-A programming selections (e.g., Preamble, Check Digit).

Scanning **DO NOT CONVERT UPC-E1 TO UPC-A** allows you to transmit UPC-E1 decoded data.



**CONVERT UPC-E1 TO UPC-A  
(ENABLE)**



**\*DO NOT CONVERT UPC-E1 TO UPC-A  
(DISABLE)**

## EAN-8 Zero Extend

---

If this parameter is enabled, five leading zeros are added to decoded EAN-8 symbols to make them compatible in format to EAN-13 symbols.

Disabling this parameter returns EAN-8 symbols to their normal format.

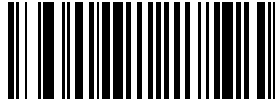

**ENABLE EAN ZERO EXTEND**

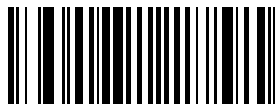

**\*DISABLE EAN ZERO EXTEND**



## **Convert EAN-8 to EAN-13 Type**

---

When EAN Zero Extend is enabled, this parameter gives you the option of labeling the extended symbol as either an EAN-13 bar code, or an EAN-8 bar code.

When EAN Zero Extend is disabled, this parameter has no effect on bar code data.



**\*TYPE IS EAN-13**



**TYPE IS EAN-8**

## UPC/EAN Security Level

---

The scanner offers four levels of decode security for UPC/EAN bar codes. Increasing levels of security are provided for decreasing levels of bar code quality. There is an inverse relationship between security and scanner aggressiveness, so be sure to choose only that level of security necessary for any given application.

### ***UPC/EAN Security Level 0***

This is the default setting which allows the scanner to operate in its most aggressive state, while providing sufficient security in decoding “in-spec” UPC/EAN bar codes.

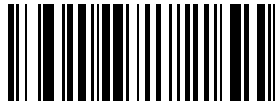

**\*UPC/EAN SECURITY LEVEL 0**

### ***UPC/EAN Security Level 1***

As bar code quality levels diminish, certain characters become prone to mis-decodes before others (i.e., 1, 2, 7, 8). If you are experiencing mis-decodes of poorly printed bar codes, and the mis-decodes are limited to these characters, select this security level.

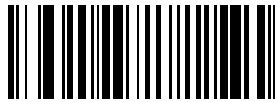

**UPC/EAN SECURITY LEVEL 1**



## UPC/EAN Security Level (Continued)

---

### ***UPC/EAN Security Level 2***

If you are experiencing mis-decodes of poorly printed bar codes, and the mis-decodes are not limited to characters 1, 2, 7, and 8, select this security level.

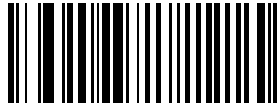

**UPC/EAN SECURITY LEVEL 2**

### ***UPC/EAN Security Level 3***

If you have tried Security Level 2, and are still experiencing misdecodes, select this security level. Be advised that selecting this option is an extreme measure against mis-decoding severely out of spec bar codes. Selection of this level of security significantly impairs the decoding ability of the scanner. If this level of security is necessary, you should try to improve the quality of your bar codes.

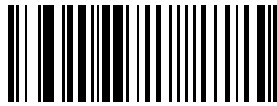

**UPC/EAN SECURITY LEVEL 3**



## UPC/EAN Coupon Code

---

When this parameter is enabled, the scanner decodes UPC-A, UPC-A with 2 supplemental characters, UPC-A with 5 supplemental characters, and UPC-A/EAN128 bar codes.

[AUTODISCRIMINATE UPC/EAN SUPPLEMENTALS](#) on page 5-31 must be enabled.



**ENABLE UPC/EAN COUPON CODE**



**\*DISABLE UPC/EAN COUPON CODE**



## Enable/Disable Code 128

---

Scan the appropriate bar code below to enable or disable Code 128.

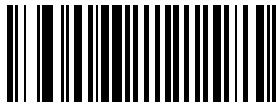

**\*ENABLE CODE 128**

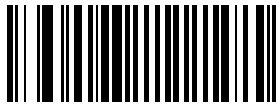

**DISABLE CODE 128**

---

**Note:** *The “|” character and the NULL character cannot be embedded in the barcode to be scanned when using Code 128.*

---

## Enable/Disable UCC/EAN-128

---

Scan the appropriate bar code below to enable or disable UCC/EAN-128. (See [Appendix A, Bar Code Information](#) for details on UCC/EAN-128.)

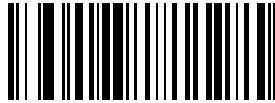

**\*ENABLE UCC/EAN-128**

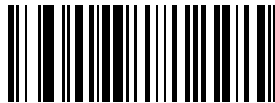

**DISABLE UCC/EAN-128**



## **Lengths for Code 128**

---

No length setting is required for Code 128. The default setting is Any Length.

## Enable/Disable ISBT 128

---

To enable or disable ISBT 128, scan the appropriate bar code below.



**\*Enable ISBT 128**



**Disable ISBT 128**



## **Enable/Disable Code 39**

---

Scan the appropriate bar code below to enable or disable Code 39.



**\*ENABLE CODE 39**

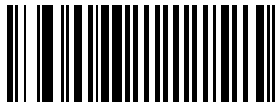

**DISABLE CODE 39**

## Enable/Disable Trioptic Code 39

---

Trioptic Code 39 symbols always contain six characters. Trioptic Code 39 and Code 39 Full ASCII cannot be enabled simultaneously. If you get an error beep when enabling Trioptic Code 39, disable Code 39 Full ASCII and try again. To enable or disable Trioptic Code 39, scan the appropriate bar code below.



**ENABLE TRIOPTIC CODE 39**



**\*DISABLE TRIOPTIC CODE 39**



## Set Lengths for Code 39

---

Lengths for Code 39 may be set for any length, one or two discrete lengths, or lengths within a specific range. The length of a code refers to the number of characters (i.e., human readable characters), including check digit(s) the code contains. If Code 39 Full ASCII is enabled, **Length Within a Range** or **Any Length** are the preferred options.

**One Discrete Length** - This option allows you to decode only those codes containing a selected length. For example, if you select **Code 39 One Discrete Length**, then scan **1, 4**, only Code 39 symbols containing 14 characters are decoded. Numeric bar codes begin on page [5-104](#). If you make an error, or wish to change your selection, scan **CANCEL** on page 5-106.



**CODE 39 - ONE DISCRETE LENGTH**

**Two Discrete Lengths** - This option allows you to decode only those codes containing two selected lengths. For example, if you select **Code 39 Two Discrete Lengths**, then scan **0, 2, 1, 4**, only Code 39 symbols containing 2 or 14 characters are decoded. Numeric bar codes begin on page [5-104](#). If you make an error, or wish to change your selection, scan **CANCEL** on page 5-106.



**CODE 39 - TWO DISCRETE LENGTHS**



## Set Lengths for Code 39 (Continued)

---

**Length Within Range** - This option allows you to decode a code type within a specified range. For example to decode Code 39 symbols containing between 4 and 12 characters, first scan **Code 39 Length Within Range**. Then scan **0, 4, 1** and **2** (single digit numbers must always be preceded by a leading zero). Numeric bar codes begin on page [5-104](#). If you make an error, or wish to change your selection, scan **CANCEL** on page 5-106.



**CODE 39 - LENGTH WITHIN RANGE**

**Any Length** - Scanning this option allows you to decode Code 39 symbols containing any number of characters.



**CODE 39 - ANY LENGTH**



## **Code 39 Check Digit Verification**

---

When enabled, this parameter checks the integrity of a Code 39 symbol to ensure it complies with specified algorithms.

Only those Code 39 symbols which include a modulo 43 check digit are decoded when this parameter is enabled.

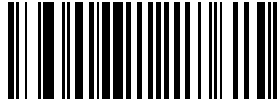

**ENABLE CODE 39 CHECK DIGIT**

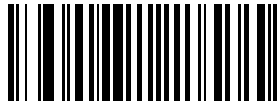

**\*DISABLE CODE 39 CHECK DIGIT**

## Transmit Code 39 Check Digit

---

Scan the appropriate bar code below to transmit the data with or without the check digit.



**TRANSMIT CODE 39 CHECK DIGIT  
(ENABLE)**



**\*DO NOT TRANSMIT CODE 39 CHECK DIGIT  
(DISABLE)**



## Enable/Disable Code 39 Full ASCII

---

Scan the appropriate bar code below to enable or disable Code 39 Full ASCII.

When enabled, the ASCII character set assigns a code to letters, punctuation marks, numerals, and most control keystrokes on the keyboard.

The first 32 codes are non-printable and are assigned to keyboard control characters such as BACKSPACE and RETURN. The other 96 are called printable codes because all but SPACE and DELETE produce visible characters.

Code 39 Full ASCII interprets the bar code special character (\$ + % /) preceding a Code 39 character and assigns an ASCII character value to the pair. For example, when Code 39 Full ASCII is enabled and a **+B** is scanned, it is interpreted as **b**, **%J** as **?**, and **\$H** emulates the keystroke **BACKSPACE**. Scanning **ABC\$M** will output the keystroke equivalent of **ABC ENTER**. Refer to the ASCII table in *Appendix A*.

Code 39 Full ASCII and Trioptic Code 39 cannot be enabled simultaneously. If you get an error beep when enabling Code 39 Full ASCII, disable Trioptic Code 39 and try again.

The scanner does not autodiscriminate between Code 39 and Code 39 Full ASCII.



**ENABLE CODE 39 FULL ASCII**



**\*DISABLE CODE 39 FULL ASCII**

---

**Note:** The “]” character and the NULL character cannot be embedded in the barcode to be scanned when using Code 39 Full ASCII.

---

## Convert Code 39 to Code 32

---

Scan the appropriate bar code below to enable or disable converting Code 39 to Code 32.

---

**Note:** Code 39 must be enabled in order for this parameter to function.

---



**CONVERT CODE 39 TO CODE 32  
(ENABLE)**



**\*DO NOT CONVERT CODE 39 TO CODE 32  
(DISABLE)**



## Code 32 Prefix

---

Scan the appropriate bar code below to enable or disable the prefix character “A” to all Code 32 bar codes.

---

**Note:** *Convert Code 39 to Code 32 must be enabled for this parameter to function.*

---



**ENABLE CODE 32 PREFIX**



**\*DISABLE CODE 32 PREFIX**

## Enable/Disable Code 93

---

Scan the appropriate bar code below to enable or disable Code 93.



**ENABLE CODE 93**



**\*DISABLE CODE 93**



## Set Lengths for Code 93

---

Lengths for Code 93 may be set for any length, one or two discrete lengths, or lengths within a specific range. The length of a code refers to the number of characters (i.e., human readable characters), including check digit(s) the code contains.

**One Discrete Length** - This option allows you to decode only those codes containing a selected length. For example, if you select **Code 93 One Discrete Length**, then scan **1, 4**, only Code 93 symbols containing 14 characters are decoded. Numeric bar codes begin on page [5-104](#). If you make an error, or wish to change your selection, scan **CANCEL** on page 5-106.



**CODE 93 - ONE DISCRETE LENGTH**

**Two Discrete Lengths** - This option allows you to decode only those codes containing two selected lengths. For example, if you select **Code 93 Two Discrete Lengths**, then scan **0, 2, 1, 4**, only Code 93 symbols containing 2 or 14 characters are decoded. Numeric bar codes begin on page [5-104](#). If you make an error, or wish to change your selection, scan **CANCEL** on page 5-106.



**CODE 93 - TWO DISCRETE LENGTHS**



## Set Lengths for Code 93 (Continued)

---

**Length Within Range** - This option allows you to decode a code type within a specified range. For example to decode Code 93 symbols containing between 4 and 12 characters, first scan **Code 93 Length Within Range**. Then scan **0, 4, 1** and **2** (single digit numbers must always be preceded by a leading zero). Numeric bar codes begin on page [5-104](#). If you make an error, or wish to change your selection, scan **CANCEL** on page 5-106.



**CODE 93 - LENGTH WITHIN RANGE**

**Any Length** - Scanning this option allows you to decode Code 93 symbols containing any number of characters.



**CODE 93 - ANY LENGTH**



## **Enable/Disable Interleaved 2 of 5**

---

Scan the appropriate bar code below to enable or disable Interleaved 2 of 5.



**\*ENABLE INTERLEAVED 2 OF 5**

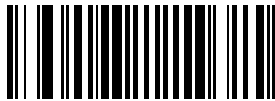

**DISABLE INTERLEAVED 2 OF 5**

## Set Lengths for Interleaved 2 of 5

---

Lengths for I 2 of 5 may be set for any length, one or two discrete lengths, or lengths within a specific range. The length of a code refers to the number of characters (i.e., human readable characters) the code contains and includes check digits.

**One Discrete Length** - This option allows you to decode only those codes containing a selected length. For example, if you select **I 2 of 5 One Discrete Length**, then scan **1, 4**, the only I 2 of 5 symbols decoded are those containing 14 characters. Numeric bar codes begin on page [5-104](#). If you make an error, or wish to change your selection, scan [CANCEL](#) on page 5-106.



**I 2 of 5 - ONE DISCRETE LENGTH**

**Two Discrete Lengths** - This option allows you to decode only those codes containing two selected lengths. For example, if you select **I 2 of 5 Two Discrete Lengths**, then scan **0, 2, 1, 4**, the only I 2 of 5 symbols decoded are those containing 2 or 14 characters. Numeric bar codes begin on page [5-104](#). If you make an error, or wish to change your selection, scan [CANCEL](#) on page 5-106.



**I 2 of 5 - TWO DISCRETE LENGTHS**



## Set Lengths for Interleaved 2 of 5 (Continued)

---

**Length Within Range** - This option allows you to decode a code type within a specified range. For example to decode I 2 of 5 symbols containing between 4 and 12 characters, first scan **I 2 of 5 Length Within Range**. Then scan **0, 4, 1** and **2** (single digit numbers must always be preceded by a leading zero). Numeric bar codes begin on page [5-104](#). If you make an error, or wish to change your selection, scan **CANCEL** on page 5-106.



**I 2 of 5 - LENGTH WITHIN RANGE**

**Any Length** - Scanning this option allows you to decode I 2 of 5 symbols containing any number of characters.

---

**Note:** *Selecting this option may lead to mis-decodes for I 2 of 5 codes.*

---



**I 2 of 5 - ANY LENGTH**

## I 2 of 5 Check Digit Verification

---

When enabled, this parameter checks the integrity of an I 2 of 5 symbol to ensure it complies with a specified algorithm, either USS (Uniform Symbology Specification), or OPCC (Optical Product Code Council).



**\*DISABLE**



**USS CHECK DIGIT**



**OPCC CHECK DIGIT**



## **Transmit I 2 of 5 Check Digit**

---

Scan the appropriate bar code below to transmit the data with or without the check digit.



**TRANSMIT I 2 of 5 CHECK DIGIT  
(ENABLE)**



**\*DO NOT TRANSMIT I 2 of 5 CHECK DIGIT  
(DISABLE)**

## Convert I 2 of 5 to EAN-13

---

This parameter converts a 14 character I 2 of 5 code into EAN-13, and transmits to the host as EAN-13. In order to accomplish this, the I 2 of 5 code must be enabled, one length must be set to 14, and the code must have a leading zero and a valid EAN-13 check digit.



**CONVERT I 2 of 5 to EAN-13  
(ENABLE)**



**\*DO NOT CONVERT I 2 of 5 to EAN-13  
(DISABLE)**



## **Enable/Disable Discrete 2 of 5**

---

Scan the appropriate bar code below to enable or disable Discrete 2 of 5.



**ENABLE DISCRETE 2 OF 5**



**\*DISABLE DISCRETE 2 OF 5**



## Set Lengths for Discrete 2 of 5

---

Lengths for D 2 of 5 may be set for any length, one or two discrete lengths, or lengths within a specific range. The length of a code refers to the number of characters (i.e., human readable characters) the code contains, and includes check digits.

**One Discrete Length** - This option allows you to decode only those codes containing a selected length. For example, if you select **D 2 of 5 One Discrete Length**, then scan **1, 4**, the only D 2 of 5 symbols decoded are those containing 14 characters. Numeric bar codes begin on page [5-104](#). If you make an error, or wish to change your selection, scan [CANCEL](#) on page 5-106.



**D 2 of 5 - ONE DISCRETE LENGTH**

**Two Discrete Lengths** - This option allows you to decode only those codes containing two selected lengths. For example, if you select **D 2 of 5 Two Discrete Lengths**, then scan **0, 2, 1, 4**, the only D 2 of 5 symbols decoded are those containing 2 or 14 characters. Numeric bar codes begin on page [5-104](#). If you make an error, or wish to change your selection, [CANCEL](#) on page 5-106.



**D 2 of 5 - TWO DISCRETE LENGTHS**



## Set Lengths for Discrete 2 of 5 (Continued)

---

**Length Within Range** - This option allows you to decode a code type within a specified range. For example to decode D 2 of 5 symbols containing between 4 and 12 characters, first scan **D 2 of 5 Length Within Range**. Then scan **0, 4, 1** and **2** (single digit numbers must always be preceded by a leading zero). Numeric bar codes begin on page [5-104](#). If you make an error, or wish to change your selection, scan **CANCEL** on page 5-106.



**D 2 of 5 - LENGTH WITHIN RANGE**

**Any Length** - Scanning this option allows you to decode D 2 of 5 symbols containing any number of characters.

---

**Note:** *Selecting this option may lead to mis-decodes for D 2 of 5 codes.*

---



**D 2 of 5 - ANY LENGTH**

## Enable/Disable Codabar

---

Scan the appropriate bar code below to enable or disable Codabar.

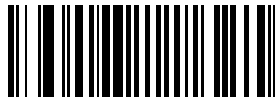

**ENABLE CODABAR**

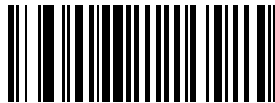

**\*DISABLE CODABAR**



## Set Lengths for Codabar

---

Lengths for Codabar may be set for any length, one or two discrete lengths, or lengths within a specific range. The length of a code refers to the number of characters (i.e., human readable characters) the code contains. It also includes any start or stop characters.

**One Discrete Length** - This option allows you to decode only those codes containing a selected length. For example, if you select **Codabar One Discrete Length**, then scan **1, 4**, the only Codabar symbols decoded are those containing 14 characters. Numeric bar codes begin on page [5-104](#). If you make an error, or wish to change your selection, scan **CANCEL** on page 5-106.



**CODABAR - ONE DISCRETE LENGTH**

**Two Discrete Lengths** - This option allows you to decode only those codes containing two selected lengths. For example, if you select **Codabar Two Discrete Lengths**, then scan **0, 2, 1, 4**, the only Codabar symbols decoded are those containing 2 or 14 characters. Numeric bar codes begin on page [5-104](#). If you make an error, or wish to change your selection, scan **CANCEL** on page 5-106.



**CODABAR - TWO DISCRETE LENGTHS**

## Set Lengths for Codabar (Continued)

---

**Length Within Range** - This option allows you to decode a code type within a specified range. For example to decode Codabar symbols containing between 4 and 12 characters, first scan **Codabar Length Within Range**. Then scan **0, 4, 1** and **2** (single digit numbers must always be preceded by a leading zero). Numeric bar codes begin on page [5-104](#). If you make an error, or wish to change your selection, scan **CANCEL** on page 5-106.



**CODABAR - LENGTH WITHIN RANGE**

**Any Length** - Scanning this option allows you to decode Codabar symbols containing any number of characters.



**CODABAR - ANY LENGTH**



## CLSI Editing

---

If enabled, this parameter strips the start and stop characters and inserts a space after the first, fifth, and tenth characters of a 14-character Codabar symbol.

---

**Note:** *Symbol length does not include start and stop characters.*

---

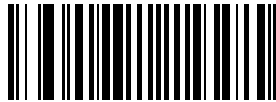

**ENABLE CLSI EDITING**



**\*DISABLE CLSI EDITING**

## NOTIS Editing

---

If enabled, this parameter strips the start and stop characters from a decoded Codabar symbol.

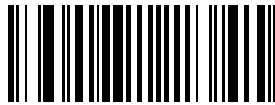

**ENABLE NOTIS EDITING**

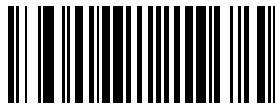

**\*DISABLE NOTIS EDITING**



## **Enable/Disable MSI Plessey**

---

Scan the appropriate bar code below to enable or disable MSI Plessey.



**ENABLE MSI PLESSEY**



**\*DISABLE MSI PLESSEY**



## Set Lengths for MSI Plessey

---

Lengths for MSI Plessey may be set for any length, one or two discrete lengths, or lengths within a specific range. The length of a code refers to the number of characters (i.e., human readable characters) the code contains, and includes check digits.

**One Discrete Length** - This option allows you to decode only those codes containing a selected length. For example, if you select **MSI Plessey One Discrete Length**, then scan **1, 4**, the only MSI Plessey symbols decoded are those containing 14 characters. Numeric bar codes begin on page [5-104](#). If you make an error, or wish to change your selection, scan [CANCEL](#) on page 5-106.



**MSI PLESSEY - ONE DISCRETE LENGTH**

**Two Discrete Lengths** - This option allows you to decode only those codes containing two selected lengths. For example, if you select **MSI Plessey Two Discrete Lengths**, then scan **0, 2, 1, 4**, the only MSI Plessey symbols decoded are those containing 2 or 14 characters. Numeric bar codes begin on page [5-104](#). If you make an error, or wish to change your selection, scan [CANCEL](#) on page 5-106.

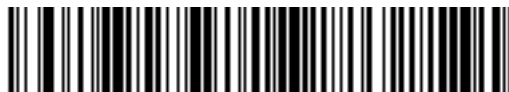

**MSI PLESSEY - TWO DISCRETE LENGTHS**



## Set Lengths for MSI Plessey (Continued)

---

**Length Within Range** - This option allows you to decode a code type within a specified range. For example to decode MSI Plessey symbols containing between 4 and 12 characters, first scan **MSI Plessey Length Within Range**. Then scan **0, 4, 1** and **2** (single digit numbers must always be preceded by a leading zero). Numeric bar codes begin on page [5-104](#). If you make an error, or wish to change your selection, scan **CANCEL** on page 5-106.



**MSI PLESSEY - LENGTH WITHIN RANGE**

**Any Length** - Scanning this option allows you to decode MSI Plessey symbols containing any number of characters.

---

**Note:** *Selecting this option may lead to mis-decodes for MSI Plessey codes.*

---



**\*MSI PLESSEY - ANY LENGTH**

## MSI Plessey Check Digits

---

These check digits at the end of the bar code verify the integrity of the data. At least one check digit is always required. Check digits are not automatically transmitted with the data.



**\*ONE MSI PLESSEY CHECK DIGIT**



**TWO MSI PLESSEY CHECK DIGITS**



## **Transmit MSI Plessey Check Digit**

---

Scan the appropriate bar code below to transmit the data with or without the check digit.



**TRANSMIT MSI PLESSEY CHECK DIGIT  
(ENABLE)**



**\*DO NOT TRANSMIT MSI PLESSEY CHECK DIGIT  
(DISABLE)**

## MSI Plessey Check Digit Algorithm

---

When the two MSI Plessey check digits option is selected, an additional verification is required to ensure integrity. Either of the two following algorithms may be selected.



**MOD 10/MOD 11**



**\*MOD 10/MOD 10**

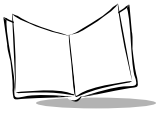

## Transmit Code ID Character

---

A code ID character identifies the code type of a scanned bar code. This may be useful when the scanner is decoding more than one code type. The code ID character precedes the decoded symbol.

The user may select no code ID character, a Symbol Code ID character, or an AIM Code ID character. The Symbol Code ID characters are listed below; see [Appendix A, Bar Code Information](#) for AIM Identifiers.

### ***Symbol Code ID Characters***

A = UPC-A, UPC-E, EAN-8, EAN-13

B = Code 39

C = Codabar

D = Code 128

E = Code 93

F = Interleaved 2 of 5

G = Discrete 2 of 5, or Discrete 2 of 5 IATA

J = MSI Plessey

K = UCC/EAN-128

L = Bookland EAN

M = Trioptic Code 39

N = Coupon Code

## Transmit Code ID Character (Continued)

---

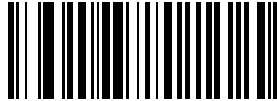

**SYMBOL CODE ID CHARACTER**

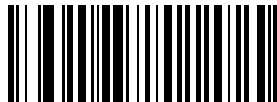

**AIM CODE ID CHARACTER**

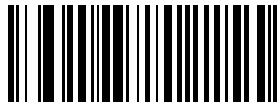

**\*NONE**



## Pause Duration

---

This parameter allows a pause to be inserted at any point in the data transmission. Pauses are set by scanning the bar code below followed by a two digit number (i.e. two bar codes), and are measured in 1/10 second intervals. For example, scanning bar codes "0" and "1" inserts a 1/10 second pause; "0" and "5" gives you a 1/2 second delay. Numeric bar codes begin on page [5-104](#). If you make an error, or wish to change your selection, scan [CANCEL](#) on page 5-106.



**PAUSE DURATION**



## RS-232C Parameters

---

### ***Baud Rate***

Baud rate is the number of bits of data transmitted per second. The scanner's baud rate setting should match the data rate setting of the host device. If not, data may not reach the host device or may reach it in distorted form.

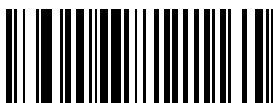

**BAUD RATE 600**



**BAUD RATE 1200**



**BAUD RATE 2400**



## **Baud Rate (Continued)**



**BAUD RATE 4800**

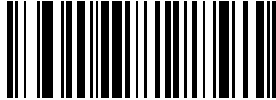

**\*BAUD RATE 9600**



**BAUD RATE 19,200**



**BAUD RATE 38,400**

## **Parity**

A parity check bit is the most significant bit of each ASCII coded character. Select the parity type according to host device requirements.

If you select **ODD** parity, the parity bit has a value 0 or 1, based on data, to ensure that an odd number of 1 bits are contained in the coded character.

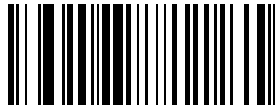

**ODD**

If you select **EVEN** parity, the parity bit has a value 0 or 1, based on data, to ensure that an even number of 1 bits are contained in the coded character.

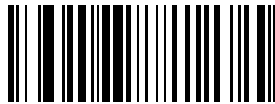

**EVEN**



## **Parity (Continued)**

Select **MARK** parity and the parity bit is always 1.

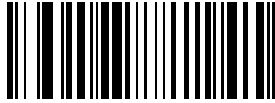

**MARK**

Select **SPACE** parity and the parity bit is always 0.

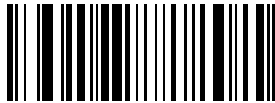

**SPACE**

If no parity is required, select **NONE**.



**\*NONE**

## **Check Receive Errors**

Select whether or not the parity, framing, and overrun of received characters are checked. The type of parity used is selectable through the **PARITY** parameter.

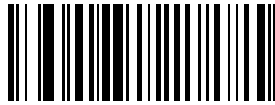

**CHECK FOR RECEIVED ERRORS**

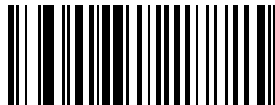

**\*DO NOT CHECK FOR RECEIVED ERRORS**



## Hardware Handshaking

The data interface consists of an RS-232C port. The port has been designed to operate either with or without the hardware handshaking lines, RTS, *Request to Send*, and CTS, *Clear to Send*.

If Standard RTS/CTS handshaking is selected, scan data is transmitted according to the following sequence:

- The scanner reads the CTS line for activity. If CTS is asserted, the scanner waits up to two seconds for the host to negate the CTS line. If, after two seconds (default), the CTS line is still asserted, the scanner sounds a transmit error and any scanned data is lost.
- When the CTS line is negated, the scanner asserts the RTS line and waits up to two seconds for the host to assert CTS. When the host asserts CTS, data is transmitted. If, after two seconds (default), the CTS line is not asserted, the scanner sounds a transmit error and discards the data.
- When data transmission is complete, the scanner negates RTS 10 msec after sending the last character.
- The host should respond by negating CTS. The scanner checks for a negated CTS upon the next transmission of data.

During the transmission of data, the CTS line should be asserted. If CTS is deasserted for more than 50 ms between characters, the transmission is aborted, the scanner sounds a transmission error, and the data is discarded.

If the above communications sequence fails, the scanner issues an error indication. In this case, the data is lost and must be rescanned.

If Hardware Handshaking and Software Handshaking are both enabled, Hardware Handshaking will take precedence.

---

**Note:** *The DTR signal is jumpered active.*

---

---

**Note:** *When using RTS/CTS handshaking and a PL 370/470 cradle, there is an 8 ms delay for the information to travel between the host and the scanner. If this setup is necessary, scan the [Intercharacter Delay](#) bar code on page 5-96 and set the delay for 10 ms or more.*

---

## **Hardware Handshaking (Continued)**

Scan the bar code below if no Hardware Handshaking is desired.

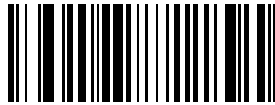

**\*NONE**

Scan the bar code below to select Standard RTS/CTS Hardware Handshaking.

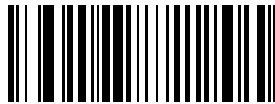

**STANDARD RTS/CTS**

When RTS/CTS Option 1 is selected, the cradle asserts RTS before transmitting and ignores the state of CTS. The scanner deasserts RTS when the transmission is complete.

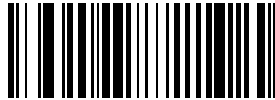

**RTS/CTS OPTION 1**



## **Hardware Handshaking (Continued)**

When Option 2 is selected, RTS is always high or low (user-programmed logic level). However, the scanner waits for CTS to be asserted before transmitting data. If CTS is not asserted within two seconds (default), the scanner issues an error indication and discards the data.

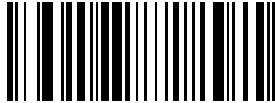

**RTS/CTS OPTION 2**

When Option 3 is selected, the scanner asserts RTS prior to any data transmission, regardless of the state of CTS. The scanner waits up to two seconds (default) for CTS to be asserted. If CTS is not asserted during this time, the scanner issues an error indication and discards the data. The scanner deasserts RTS when transmission is complete.

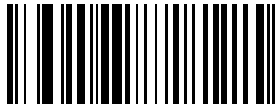

**RTS/CTS OPTION 3**



## Software Handshaking

This parameter offers control of the data transmission process in addition to, or instead of, that offered by hardware handshaking. There are five options.

If Software Handshaking and Hardware Handshaking are both enabled, Hardware Handshaking takes precedence.

### None

When this option is selected, data is transmitted immediately.

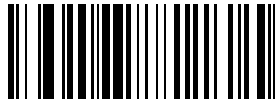

**\*NONE**

### ACK/NAK

When this option is selected, after transmitting data, the cradle expects either an ACK, *Acknowledge*, or NAK, *Negative Acknowledge*, response from the host. Whenever a NAK is received, the cradle transmits the same data again and waits for either an ACK or NAK. After three unsuccessful attempts to send data when NAKs are received, the cradle issues an error indication and discards the data.

The cradle waits up to the programmable Host Serial Response Time-out to receive an ACK or NAK. If the cradle does not get a response in this time, it issues an error indication and discards the data. There are no retries when a time-out occurs.

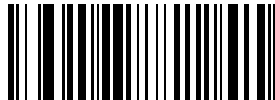

**ACK/NAK**



## Software Handshaking (Continued)

### ENQ

When this option is selected, the cradle waits for an ENQ, *Enquiry*, character from the host before transmitting data. If an ENQ is not received within two seconds, the cradle issues an error indication and discards the data. The host must transmit an ENQ character at least every two seconds to prevent transmission errors.

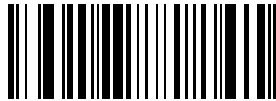

ENQ

### ACK/NAK with ENQ

This combines the two previous options.

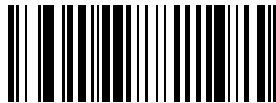

ACK/NAK with ENQ

## Software Handshaking (Continued)

### XON/XOFF

An XOFF, *Transmit Off*, character turns the scanner transmission off until the scanner receives an XON, *Transmit On*, character. There are two situations for XON/XOFF:

- XOFF is received before the scanner has data to send. When the scanner has data to send, it then waits for an XON character before transmission. The scanner waits up to two seconds to receive the XON. If the XON is not received within this time, the scanner issues an error indication and discards the data.
- XOFF is received during a transmission. Data transmission then stops after sending the current byte. When the scanner receives an XON character, it sends the rest of the data message. The scanner waits indefinitely for the XON.

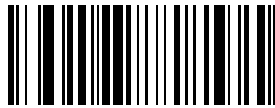

XON/XOFF



## **Host Serial Response Time-out**

This parameter specifies how long the scanner waits for an ACK, NAK or CTS before determining that a transmission error has occurred. This only applies when in one of the ACK/NAK Software Handshaking modes, or RTS/CTS Hardware Handshaking option.

The delay period can range from 0.0 to 9.9 seconds in 0.1 second increments. After scanning the bar code below, scan two numeric bar codes beginning on page [5-104](#). If you make an error, or wish to change your selection, scan [CANCEL](#) on page 5-106.

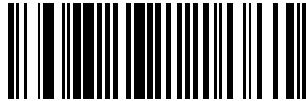

**HOST SERIAL RESPONSE TIME-OUT**

## **RTS Line State**

Scan the appropriate bar code below to set the idle state of the Serial Host RTS line. Choose LOW RTS line state or HIGH RTS line state.



**\*HOST: LOW RTS**



**HOST: HIGH RTS**

## **Stop Bit Select**

The stop bit(s) at the end of each transmitted character marks the end of transmission of one character and prepares the receiving device for the next character in the serial data stream. The number of stop bits (one or two) selected depends on the number the receiving terminal is programmed to accommodate. Set the number of stop bits to match host device requirements.

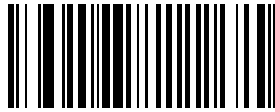

**\*1 STOP BIT**

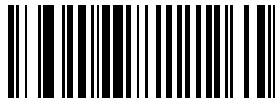

**2 STOP BITS**



## **ASCII Format**

This parameter allows the cradle to interface with devices requiring a 7-bit or 8-bit ASCII protocol.

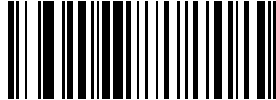

**7-BIT**

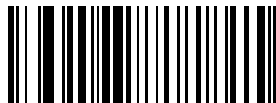

**\*8-BIT**

## **Intercharacter Delay**

Select the intercharacter delay option matching host requirements. The intercharacter delay gives the host system time to service its receiver and perform other tasks between characters. The delay period can range from no delay to 99 ms in 1 ms increments (if you are using a cradle and RTS/CTS handshaking, the delay period can range from 5 ms to 99 ms). After scanning the bar code below, scan two bar codes beginning on page [5-104](#) to set the desired time-out. If you make an error, or wish to change your selection, scan [CANCEL](#) on page 5-106.



**INTERCHARACTER DELAY**

## MCL-Net Parameters

---

### ***MCL-Net Baud Rate***

Baud rate is the number of bits of data transmitted per second. Scan the appropriate bar code below to set the MCL-Net baud rate. The default baud rate is 38400.



**BAUD RATE 600**



**BAUD RATE 1200**



**BAUD RATE 2400**



## ***MCL-Net Baud Rate (Continued)***



**BAUD RATE 4800**



**BAUD RATE 9600**



**BAUD RATE 19200**



**\*BAUD RATE 38400**



## ***MCL-Net Hex Addressing Mode***

Scan the appropriate bar code below to set the MCL-Net Hex addressing mode. The default mode is *Disabled*.



**\*MCL-NET HEX ADDRESSING DISABLED**



**MCL-NET HEX ADDRESSING ENABLED**

**Trigger Release to Scan**

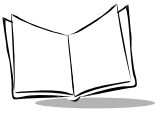

## **Scanner Address**

Scan the following barcode, followed by 3 digits from the numeric barcode section (starting on page 5-104), to set the address of the scanner (scanner ID).

The number of scanner addresses (scanner ID's) varies with the selected communication protocol.

- RS-232/Synapse range from 001 to 254
- MCL Link Lite (MCL Net) range from 001 to 002
- MCL Link (MCL Net) range from 001 to 254



**SCANNER ADDRESS**

## **MCL-Net Transmit Retries**

Scan the following barcode, followed by 2 digits from the numeric barcode section (starting on page 5-104), to define the number of retries in the range 1 to 10.

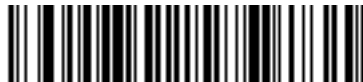

**MCL-NET RETRIES**

## **MCL-Net Frame Timeout**

Scan the following barcode, followed by 2 digits from the numeric barcode section (starting on page 5-104), to define the amount of time to wait for an ACK or NAK from the host before retransmitting. The timeout is in 100 ms increments in the range 100 ms to 3000 ms.



**MCL-NET FRAME TIMEOUT**

## **Scanner Decode Beep Type**

Select the type of beep for the scanner. This parameter is useful when two or more systems are installed in proximity of each other. Unique patterns can be set up to distinguish each system's receipt of bar code data.

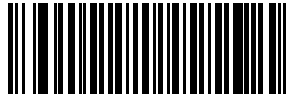

**\*BEEP TYPE 1**

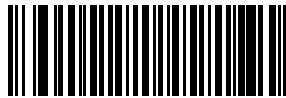

**BEEP TYPE 2**

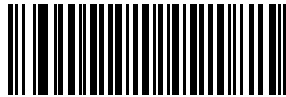

**BEEP TYPE 3**



**BEEP TYPE 4**



**BEEP TYPE 5**



## Long Range Scanning Bar Codes

---

The P370 ALR (Long Range) scanner has an aiming feature which allows the positioning of the laser beam when scanning bar codes. Aiming mode and Aiming duration can be set using the bar codes below. You cannot program this feature into the standard range P370 scanner.

### ***Aim Mode***

There are two Aiming options supported by the Phaser ALR cordless scanner, trigger pull to scan (default) and trigger release to scan.

#### **Option 1: Trigger Pull to Scan (Default)**

When you pull the trigger, the aim dot will be active for a user-selectable duration of time. After this time, the aiming dot automatically turns into a standard laser scanning beam for a full decode session. After the aiming dot turns into a scanning beam, the laser will stay on until the user-selectable laser-on timeout occurs, a decode occurs, or the trigger is released. If the trigger is released during the aim mode, the laser shut off and no decode session occurs.



**\*Trigger Pull to Scan  
(Default)**

## Option 2: Trigger Release to Scan

When you pull the trigger, the aiming dot will appear. The aiming dot remains present while the trigger is pulled or until a 60 second timeout occurs. When the trigger is released, the aiming dot turns into a standard laser scanning beam for a full decode session. The laser stays on until a decode occurs or until the user-selectable laser-on timeout occurs. If the trigger is pulled again while in a decode session, the scanner returns to its aiming mode.

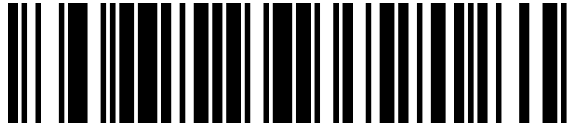

**Trigger Release to Scan  
(Default)**

## *Aim Duration*

When the scanner is in Trigger Pull to Scan mode (default mode), Aim Duration sets the amount of time the aiming dot is seen before turning into a scanning beam. This parameter has no affect when the scanner is in the Trigger Release to Scan mode.

The Aim Duration is programmable in 0.1 second increments, from 0 to 9.9 seconds. If set to 0, no aiming pattern appears before a decode session. The default value is 0.8 seconds.

To set an aim duration, scan the barcode below. Then, scan two numeric barcodes, beginning on page [5-104](#), that correspond to the desired aim duration. Durations less than 1.0 second must have a leading zero. For example, to set an aim duration of 0.5 seconds, scan the barcode below, followed by the '0' and the '5' barcodes. If you make an error or wish to change your selection, scan the CANCEL barcode on page [5-106](#).

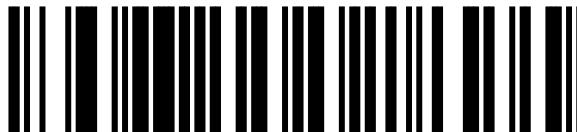

**Aim Duration**



## Numeric Bar Codes

---

For parameters requiring specific numeric values, scan the appropriately numbered bar code(s).

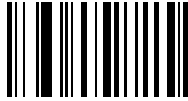

0



1

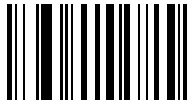

2



3



4

## Numeric Bar Codes (Continued)

---

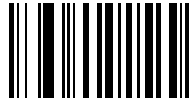

5



6

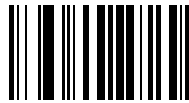

7



8



9



## Numeric Bar Codes (Continued)

---

### ***Cancel***

If you make an error, or wish to change your selection, scan the bar code below.



**CANCEL**



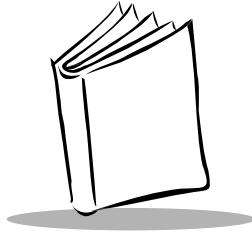

## *Appendix A*

### *Bar Code Information*

#### **UCC/EAN-128**

---

UCC/EAN-128 is a convention for printing data fields with standard Code 128 bar code symbols. UCC/EAN-128 symbols are distinguished by a leading FNC 1 character as the first or second character in the symbol. Other FNC 1 characters are used to delineate fields.

When EAN-128 symbols are read, they are transmitted after special formatting strips off the leading FNC 1 character and replaces other FNC 1 characters with the ASCII 29 GS control character.

When AIM symbology identifiers are transmitted, the modifier character indicates the position of the leading FNC 1 character according to AIM guidelines. For example, **jc1** indicates a UCC/EAN-128 symbol with a leading FNC1 character.

Standard Code 128 bar codes which do not have a leading FNC 1 may still be used, but are not encoded according to the EAN-128 convention. Standard Code 128 and UCC/EAN-128 may be mixed in an application. The scanner autodiscriminates between these symbols and can enable or disable one or both code types via bar code menus. The following table indicates the behavior of the scanner in each of the four possible parameter settings.

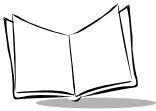

**Table A-1. Reading Standard Code128 & UCC/EAN 128**

Standard Code 128	UCC/EAN-128	Effect and Example
Disable	Disable	No Code 128 symbols can be read.
Disable	Enable	<p>Read only symbols with leading FNC 1.</p> <p>Examples:            FNC1ABCD<sup>FNC1</sup>E will be read as ABCD<sup>29</sup>E            A<sup>FNC1</sup>BCD<sup>FNC1</sup>E will be read as ABCD<sup>29</sup>E            FNC1FNC1ABCD<sup>FNC1</sup>E will be read as ABCD<sup>29</sup>E            ABCD<sup>FNC1</sup>E can not be read            ABCDE can not be read</p>
Enable	Disable	<p>Read only symbols without leading FNC 1.</p> <p>Examples:            FNC1ABCD<sup>FNC1</sup>E can not be read            A<sup>FNC1</sup>BCD<sup>FNC1</sup>E can not be read            FNC1FNC1ABCD<sup>FNC1</sup>E can not be read            ABCD<sup>FNC1</sup>E will be read as ABCD<sup>29</sup>E            ABCDE will be read as ABCDE</p>
Enable	Enable	<p>Read both types of symbols.</p> <p>Examples:            FNC1ABCD<sup>FNC1</sup>E will be read as ABCD<sup>29</sup>E            A<sup>FNC1</sup>BCD<sup>FNC1</sup>E will be read as ABCD<sup>29</sup>E            FNC1FNC1ABCD<sup>FNC1</sup>E will be read as ABCD<sup>29</sup>E            ABCD<sup>FNC1</sup>E will be read as ABCD<sup>29</sup>E            ABCDE will be read as ABCDE</p>

## AIM Code Identifiers

---

Each AIM Code Identifier contains the three-character string ]**cm** where:

- ] = Flag Character (ASCII 93)
- c = Code Character (see [Table A-2](#))
- m = Modifier Character (see [Table A-3](#))

**Table A-2. Code Characters**

Code Character	Code Type
A	Code 39
C	Code 128 (all variants)
E	UPC/EAN
F	Codabar
G	Code 93
H	Code 11
I	Interleaved 2 of 5
M	MSI Plessey
S	D2 of 5, IATA 2 of 5
X	Bookland EAN, Code 39 Trioptic, Coupon Code

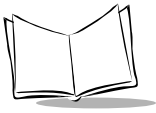

The modifier character is the sum of the applicable option values based on the following table.

**Table A-3. Modifier Characters**

Code Type	Option Value	Option
<b>Code 39</b>	0	No check character or Full ASCII processing.
	1	Reader has checked one check character.
	3	Reader has checked and stripped check character.
	4	Reader has performed Full ASCII character conversion.
	5	Reader has performed Full ASCII character conversion and checked one check character.
	7	Reader has performed Full ASCII character conversion and checked and stripped check character.
Example: A Full ASCII bar code with check character W, <b>A+I+MI+DW</b> , is transmitted as <b>J</b> A7AimId where 7 = (3+4).		
<b>Trioptic Code 39</b>	0	No option specified at this time. Always transmit 0.
	Example: A Trioptic bar code 412356 is transmitted as <b>J</b> X0412356	
<b>Code 128</b>	0	Standard data packet, no Function code 1 in first symbol position.
	1	Function code 1 in first symbol character position.
	2	Function code 1 in second symbol character position.
Example: A Code (EAN) 128 bar code with Function 1 character in the first position, <b>FNC1</b> Aim Id is transmitted as <b>J</b> C1AimId		
<b>I 2 of 5</b>	0	No check digit processing.
	1	Reader has validated check digit.
	3	Reader has validated and stripped check digit.
	Example: An I 2 of 5 bar code without check digit, 4123, is transmitted as <b>J</b> I04123	

**Table A-3. Modifier Characters (Continued)**

<b>Code Type</b>	<b>Option Value</b>	<b>Option</b>
<b>Codabar</b>	0	No check digit processing.
	1	Reader has checked check digit.
	3	Reader has stripped check digit before transmission.
	Example: A Codabar bar code without check digit, 4123, is transmitted as <b>JF0</b> 4123	
<b>Code 93</b>	0	No options specified at this time. Always transmit 0.
	Example: A Code 93 bar code 012345678905 is transmitted as <b>JG0</b> 012345678905	
<b>MSI Plessey</b>	0	Single check digit checked.
	1	Two check digits checked.
	2	Single check digit verified and stripped before transmission.
	3	Two check digits verified and stripped before transmission.
	Example: An MSI Plessey bar code 4123, with a single check digit checked, is transmitted as <b>JM0</b> 4123	
<b>D 2 of 5</b>	0	No options specified at this time. Always transmit 0.
	Example: A D 2 of 5 bar code 4123, is transmitted as <b>JS0</b> 4123	
<b>UPC/EAN</b>	0	Standard packet in full EAN country code format, which is 13 digits for UPC-A and UPC-E (not including supplemental data).
	1	Two-digit supplement data only.
	2	Five-digit supplement data only.
	4	EAN-8 data packet.
	Example: A UPC-A bar code 012345678905 is transmitted as <b>JE000</b> 12345678905	
<b>Bookland EAN</b>	0	No options specified at this time. Always transmit 0.
	Example: A Bookland EAN bar code 123456789X is transmitted as <b>JX0</b> 123456789X	



According to AIM standards, a UPC with supplemental bar code is transmitted in one of the following formats:

**JE0** (UPC chars) (terminator) **JE2** (supplemental) (terminator) or

**JE2** (supplemental) (terminator) **JE0** (UPC chars) (terminator)

In the scanner, however, the format is changed to:

**JE0** (UPC chars) **JE2** (supplemental)

Therefore, a UPC with two supplemental characters, 01234567890510, is transmitted to the host as a 21-character string, **JE00012345678905JE110**.

**Table A-4. Symbol Code Identifier Characters**

Code Type	Symbol Identifier
UPC-A, UPC-E, EAN-13, EAN-8	A
Code 39	B
Codabar	C
Code 128	D
Code 93	E
Interleaved 2 of 5	F
Discrete 2 of 5, D 2 of 5 IATA	G
MSI Plessey	J
UCC/EAN 128	K
Bookland EAN	L
Trioptic Code 39	M

**Table A-5. ASCII Character Set**

<b>ASCII Value</b>	<b>Full ASCII Code 39 Encode Char.</b>	<b>Keystroke</b>	<b>ASCII Value</b>	<b>Full ASCII Code 39 Encode Char</b>	<b>Keystroke</b>
1000	%U	CTRL 2	1024	\$X	CTRL X
1001	\$A	CTRL A	1025	\$Y	CTRL Y
1002	\$B	CTRL B	1026	\$Z	CTRL Z
1003	\$C	CTRL C	1027	%A	CTRL [
1004	\$D	CTRL D	1028	%B	CTRL \
1005	\$E	CTRL E	1029	%C	CTRL ]
1006	\$F	CTRL F	1030	%D	CTRL 6
1007	\$G	CTRL G	1031	%E	CTRL -
1008	\$H	CTRL H	1032	Space	Space
1009	\$I	CTRL I	1033	/A	!
1010	\$J	CTRL J	1034	/B	'
1011	\$K	CTRL K	1035	/C	#
1012	\$L	CTRL L	1036	/D	\$
1013	\$M	CTRL M	1037	/E	%
1014	\$N	CTRL N	1038	/F	&
1015	\$O	CTRL O	1039	/G	'
1016	\$P	CTRL P	1040	/H	(
1017	\$Q	CTRL Q	1041	/I	)
1018	\$R	CTRL R	1042	/J	*
1019	\$S	CTRL S	1043	/K	+
1020	\$T	CTRL T	1044	/L	,
1021	\$U	CTRL U	1045	-	-
1022	\$V	CTRL V	1046	.	.
1023	\$W	CTRL W	1047	/	/

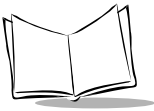

**Table A-5. ASCII Character Set (Continued)**

<b>ASCII Value</b>	<b>Full ASCII Code 39 Encode Char.</b>	<b>Keystroke</b>	<b>ASCII Value</b>	<b>Full ASCII Code 39 Encode Char</b>	<b>Keystroke</b>
1048	0	0	1073	I	I
1049	1	1	1074	J	J
1050	2	2	1075	K	K
1051	3	3	1076	L	L
1052	4	4	1077	M	M
1053	5	5	1078	N	N
1054	6	6	1079	O	O
1055	7	7	1080	P	P
1056	8	8	1081	Q	Q
1057	9	9	1082	R	R
1058	/Z	:	1083	S	S
1059	%F	;	1084	T	T
1060	%G	<	1085	U	U
1061	%H	=	1086	V	V
1062	%I	>	1087	W	W
1063	%J	?	1088	X	X
1064	%V	@	1089	Y	Y
1065	A	A	1090	Z	Z
1066	B	B	1091	%K	[
1067	C	C	1092	%L	\
1068	D	D	1093	%M	]
1069	E	E	1094	%N	^
1070	F	F	1095	%O	_
1071	G	G	1096	%W	'
1072	H	H	1097	+A	a



Table A-5. ASCII Character Set (Continued)

ASCII Value	Full ASCII Code 39 Encode Char.	Keystroke	ASCII Value	Full ASCII Code 39 Encode Char	Keystroke
1098	+B	b	1113	+Q	q
1099	+C	c	1114	+R	r
1100	+D	d	1115	+S	s
1101	+E	e	1116	+T	t
1102	+F	f	1117	+U	u
1103	+G	g	1118	+V	v
1104	+H	h	1119	+W	w
1105	+I	i	1120	+X	x
1106	+J	j	1121	+Y	y
1107	+K	k	1122	+Z	z
1108	+L	l	1123	%P	{
1109	+M	m	1124	%Q	
1110	+N	n	1125	%R	}
1111	+O	o	1126	%S	~
1112	+P	p	1127		Undefined

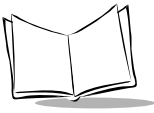

**Table A-5. ASCII Character Set (Continued)**

<b>ALT Keys</b>	<b>Keystroke</b>	<b>ALT Keys</b>	<b>Keystroke</b>	<b>ALT Keys</b>	<b>Keystroke</b>
2064	ALT 2	2075	ALT K	2086	ALT V
2065	ALT A	2076	ALT L	2087	ALT W
2066	ALT B	2077	ALT M	2088	ALT X
2067	ALT C	2078	ALT N	2089	ALT Y
2068	ALT D	2079	ALT O	2090	ALT Z
2069	ALT E	2080	ALT P	2091	ALT [
2070	ALT F	2081	ALT Q	2092	ALT \
2071	ALT G	2082	ALT R	2093	ALT ]
2072	ALT H	2083	ALT S	2094	ALT 6
2073	ALT I	2084	ALT T	2095	ALT -
2074	ALT J	2085	ALT U		
<b>Misc. Key</b>	<b>Keystroke</b>	<b>Misc. Key</b>	<b>Keystroke</b>	<b>Misc. Key</b>	<b>Keystroke</b>
3001	PA 1	3009	CMD 7	3017	°
3002	PA 2	3010	CMD 8	3018	1/2
3003	CMD 1	3011	CMD 9	3019	¶
3004	CMD 2	3012	CMD 10	3020	§
3005	CMD 3	3013	¥	3021	
3006	CMD 4	3014	£	3022	0/00
3007	CMD 5	3015	¤		
3008	CMD 6	3016	¬		

Table A-5. ASCII Character Set (Continued)

<b>PF Keys</b>	<b>Keystroke</b>	<b>PF Keys</b>	<b>Keystroke</b>	<b>PF Keys</b>	<b>Keystroke</b>
4001	PF 1	4009	PF 9	4017	PF 17
4002	PF 2	4010	PF 10	4018	PF 18
4003	PF 3	4011	PF 11	4019	PF 19
4004	PF 4	4012	PF 12	4020	PF 20
4005	PF 5	4013	PF 13	4021	PF 21
4006	PF 6	4014	PF 14	4022	PF 22
4007	PF 7	4015	PF 15	4023	PF 23
4008	PF 8	4016	PF 16	4024	PF 24
<b>F Keys</b>	<b>Keystroke</b>	<b>F Keys</b>	<b>Keystroke</b>	<b>F Keys</b>	<b>Keystroke</b>
5001	F 1	5014	F 14	5027	F 27
5002	F 2	5015	F 15	5028	F 28
5003	F 3	5016	F 16	5029	F 29
5004	F 4	5017	F 17	5030	F 30
5005	F 5	5018	F 18	5031	F 31
5006	F 6	5019	F 19	5032	F 32
5007	F 7	5020	F 20	5033	F 33
5008	F 8	5021	F 21	5034	F 34
5009	F 9	5022	F 22	5035	F 35
5010	F 10	5023	F 23	5036	F 36
5011	F 11	5024	F 24	5037	F 37
5012	F 12	5025	F 25	5038	F 38
5013	F 13	5026	F 26	5039	F 39



**Table A-5. ASCII Character Set (Continued)**

<b>Numeric Keypad</b>	<b>Keystroke</b>	<b>Numeric Keypad</b>	<b>Keystroke</b>	<b>Numeric Keypad</b>	<b>Keystroke</b>
6042	*	6049	1	6056	8
6043	+	6050	2	6057	9
6044	Undefined	6051	3	6058	Enter
6045	-	6062	4	6059	Num Lock
6046	.	6063	5	6060	00
6047	/	6064	6		
6048	0	6065	7		
<b>Extended Keypad</b>	<b>Keystroke</b>	<b>Extended Keypad</b>	<b>Keystroke</b>	<b>Extended Keypad</b>	<b>Keystroke</b>
7001	Break	7008	Backspace	7015	Up Arrow
7002	Delete	7009	Tab	7016	Dn Arrow
7003	Pg Up	7010	Print Screen	7017	Left Arrow
7004	End	7011	Insert	7018	Right Arrow
7005	Pg Dn	7012	Home	7019	Back Tab
7006	Pause	7013	Enter		
7007	Scroll Lock	7014	Escape		

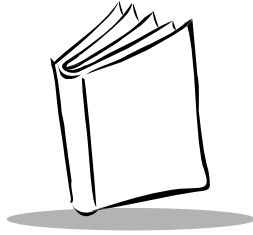

## *Appendix B*

# *Automatic Project Download*

The Phaser P470/P370 RF scanner is shipped from the factory with a pre-installed default application. This fully functional application allows the scanner to be used “out of the box”. If you need to load your own application into the scanner, the “Automatic Project Download” feature will simplify the process.

When the default application is running, and the scanner is placed into its paired cradle, the scanner will query the *MCL-Link* host for data in a file named “PHASER.CFG”. The scanner will use the information in this file to find the project directory which the user wishes to have loaded into the scanner, and will then execute the PROJECT.CMD” script which exists in the directory. This script will automatically download all program and data files relevant to the project to the scanner and will reset the scanner making it ready to run the user’s application.

In order to utilize this mechanism, the user needs only generate the PHASER.CFG file and place it in the directory specified in the *MCL-Link* setup screen as the “General path for data files”. Any text editor may be used to create this file; the contents of the file are as follows:

```
x|<path name to the user’s project>
```

The X| at the beginning of the line are required for the MCL-Net CR command to recognize this file and read the data. The path name should include the entire path hierarchy. Also, all backslashes (\) in the path name should be replaced with the string “\5C”, so that the MCL code running on the scanner does not inadvertently convert part of the path name to the equivalent Hex Character.

An example PHASER.CFG file is shown below:

```
x|c:\5Cmcl-p460\5Cdesigner\5Csample1.prj
```



Note that designer always appends the .prj suffix to the directories it creates to store project files.

The PROJECT.CMD file will be automatically generated by the MCL-Designer application.

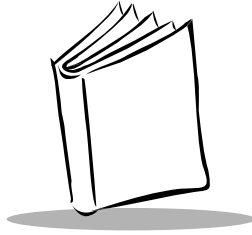

## Appendix C Radio Channels

### Cordless Phaser RF Channels Per Country

---

The cordless Phaser scanner operates continuously on a single, programmable channel (frequency) between 2.402 GHz (channel 02) and 2.483 GHz (channel 83).

A maximum of 82 channels are available. Not all channels are available in all countries. If a channel is not legal to use in your country, an error beep will be heard instead of a successful warble.

See [Table C-1](#) for a list of channel availability by Country.

---

**Note:** *Although the cordless Phaser scanner has been certified for operation in all countries listed in [Table C-1](#), not all country configurations are available for order. Consult your local Symbol reseller for more information.*

---

Table C-1. RF Channels Per Country

Country	Total Channels	First Channel	Last Channel
ARGENTINA	82	2	83
AUSTRALIA	82	2	83
AUSTRIA	82	2	83
BELGIUM	82	2	83

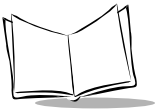

Table C-1. RF Channels Per Country (Cont'd)

Country	Total Channels	First Channel	Last Channel
BOLIVIA	82	2	83
BRAZIL	82	2	83
CANADA	82	2	83
CHILE	82	2	83
COLOMBIA	82	2	83
COSTA RICA	82	2	83
CZECH REPUBLIC	82	2	83
DENMARK	82	2	83
DOMINICAN REPUBLIC	82	2	83
FINLAND	82	2	83
FRANCE	82	2	83
GERMANY	82	2	83
GREECE	82	2	83
GUATEMALA	82	2	83
HONDURAS	82	2	83
HONG KONG	82	2	83
HUNGARY	82	2	83
INDONESIA	82	2	83
ICELAND	82	2	83
IRELAND	82	2	83
ISRAEL	36	20	55
ITALY	82	2	83
JAPAN	80	2	81
KOREA	82	2	83



Table C-1. RF Channels Per Country (Cont'd)

Country	Total Channels	First Channel	Last Channel
LUXEMBOURG	82	2	83
MALAYSIA	82	2	83
MEXICO	32	52	83
NETHERLANDS	82	2	83
NEW ZEALAND	82	2	83
NICARAGUA	82	2	83
NORWAY	82	2	83
PERU	82	2	83
PHILIPPINES	82	2	83
POLAND	82	2	83
PORTUGAL	82	2	83
ROMANIA	82	2	83
RUSSIA	82	2	83
SAUDI ARABIA	82	2	83
SINGAPORE	82	2	83
SLOVENIA	82	2	83
SOUTH AFRICA	82	2	83
SPAIN	82	2	83
SWEDEN	82	2	83
SWITZERLAND	82	2	83
TAIWAN	80	2	81
THAILAND	82	2	83
TURKEY	82	2	83
UNITED ARAB EMIRATES	82	2	83



**Table C-1. RF Channels Per Country (Cont'd)**

<b>Country</b>	<b>Total Channels</b>	<b>First Channel</b>	<b>Last Channel</b>
UNITED KINGDOM	82	2	83
URUGUAY	82	2	83
UNITED STATES (US)	82	2	83
VENEZUELA	82	2	83

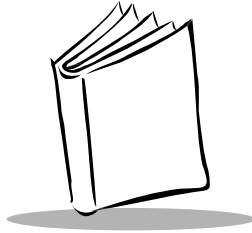

## Appendix D

# Messages and Error Codes

### Introduction

---

This Appendix contains information on messages and error codes displayed on the scanner.

### Messages

---

The scanner displays messages when certain actions are performed. If the scanner displays a message that is unfamiliar, contact the [Symbol Support Center](#) on page xi.

**Table D-1. Scanner Messages**

Message	Description
<b>Unit Cradled</b>	Scanner is properly inserted in the cradle
<b>Battery Temperature Out Of Range</b>	Battery temperature is out of range. Contact a <a href="#">Symbol Support Center</a> on page xi.
<b>Pairing Unsuccessful Push ENTER &amp; Try Again</b>	The scanner has not been successfully paired with the base (cradle). Press ENTER and then try to pair the scanner and cradle again.
<b>Failed to initiate download-Press ENTER</b>	New firmware was not successfully downloaded to the device. This message can be displayed while downloading new firmware to either the scanner or base. Cycle power (power off then on) to the base and try again.



**Table D-1. Scanner Messages (Continued)**

Message	Description
Recharge Battery	Battery is close to complete discharge. Recharge the battery

## Communication Errors

---

### *Scanning Transmission Range*

A communication error will occur when the scanner, cradle or host fails to properly communicate. When a communication error occurs while using the default application, the scanner emits 4 beeps (LO HI LO HI) and displays a "Failed Communication" error message.

Failed Communication  
Error 015 Push ENTER

The three-digit error code on the scanner's screen indicates what type of communication problem has occurred. For example, error code 015 generally indicates the scanner is out of RF range, is not properly paired with the base, or the base may have lost power. For a complete list of error codes, see [Table D-2](#).

**Table D-2. Error Codes**

Error Code	Type	Description
002	Serial Protocol Error	RS-232 host does not recognize character(s) transmitted from scanner.
003	Serial Protocol Error	Handshaking failure.
005	Serial Protocol Error	Scanner does not recognize character(s) transmitted from RS-232 host.
008	SYNAPSE Error	Synapse host does not recognize character(s) transmitted from scanner.
009	SYNAPSE Error	Synapse transmission failed. Synapse cable may not be properly installed.

**Table D-2. Error Codes**

<b>Error Code</b>	<b>Type</b>	<b>Description</b>
<b>015</b>	RF Communication Error	Scanner is out of range, not properly paired to a base or the base may have lost power.
<b>016</b>	RF Communication Error	The base to which the scanner is paired has been paired with another scanner.
<b>017</b>	RF Communication Error	Scanner is out of range.
<b>018</b>	MCL-Link Error	A Synapse cable cannot communicate with MCL-Link. Reconnect to the host using an RS-232 cable and then cycle power (power off then on) to the base.
<b>020</b>	RF Communication Error	Previous RF transmission not yet complete.
<b>021</b>	Memory Allocation Error	For repeated occurrence contact Customer Service.
<b>024</b>	RF Communication Error	The base is not responding. Cycle power (power off then on) to the base.
<b>247</b>	MCL-Link Error	MCL-Link responded with a busy message.
<b>249</b>	MCL-Link Error	MCL-Link rejected the command.
<b>253</b>	MCL-Link Error	MCL-Link or 123Scan did not respond. The base may not be properly connected to the host. make sure the RS-232 cable is properly connected and the base is receiving power. If the problem persists, cycle power (power off then on) to the base.
<p><b>Note:</b> For users developing applications, these error codes will not be shown on the display but are reported in System Variable 97 immediately after the execution of the offending command (SO, SI, NO or NI).</p>		



*P470/370 RF Scanner Product Reference Guide*

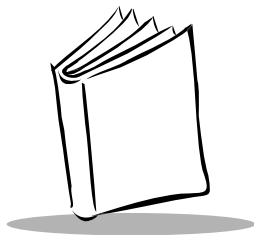

# Index

## Numerics

123Scan ..... 3-17

## A

ADF rules ..... 3-17

AIM Code Identifiers ..... A-3

aiming

    hold at an angle ..... 3-23

    scan the entire symbol ..... 3-22

alpha-numeric data entry ..... 3-3, 3-26

ALR-long range scanning

    aim duration ..... 5-103

    aiming mode ..... 5-102

    pairing with cradle ..... 2-6

ambient light immunity

    artificial light ..... 4-5

    sunlight ..... 4-5

app control

    bar code ..... 1-4, 3-9, 3-10

application downloads ..... 3-9

ASCII Character Set ..... A-7

autodiscriminate response time ..... 5-27

## B

bar codes

    autodiscriminate response time ..... 5-27

    beeper tone ..... 5-18

    beeper volume ..... 5-19

    bi-directional redundancy ..... 5-26

    codabar

        CLSI editing ..... 5-72

        enable/disable ..... 5-69

        NOTIS editing ..... 5-73

        set lengths ..... 5-70, 5-71

code 128

    enable/disable ..... 5-44

    ISBT 128 ..... 5-47

    lengths ..... 5-46

    UCC/EAN-128 ..... 5-45

code 39

    check digit verification ..... 5-52

    code 32 prefix ..... 5-56

    code 39 full ASCII ..... 5-54

    convert code 39 to code 32 ..... 5-55

    enable/disable ..... 5-48

    set lengths ..... 5-50, 5-51

    transmit code 39 check digit ..... 5-53

    trioptic code 39 ..... 5-49

code 93

    enable/disable ..... 5-57

    set lengths ..... 5-58, 5-59

convert code 39 to code 32 ..... 5-55

decimal separator ..... 5-16

discrete 2 of 5

    enable/disable ..... 5-66

    set lengths ..... 5-67, 5-68

interleaved 2 of 5

    check digit verification ..... 5-63

    convert to EAN-13 ..... 5-65

    enable/disable ..... 5-60

    set lengths ..... 5-61, 5-62

    transmit check digit ..... 5-64

key click ..... 5-17

laser on time ..... 5-22

lengths for Code 128 ..... 5-46

linear code security ..... 5-24, 5-25

load new app ..... 1-4, 3-9, 3-10

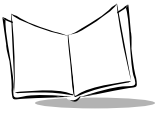

MSI plessey	
check digit algorithm	5-79
check digits	5-77
enable/disable	5-74
set lengths	5-75, 5-76
transmit check digit	5-78
numeric bar codes	5-104, 5-105, 5-106
pause duration	5-82
RS-232C parameters	
handshaking	5-92
set default	5-7
sleep time	5-15
system code	3-12
system menu	1-4, 3-7
transmit code ID character	5-80, 5-81
transmit "no read"	5-23
UPC-A/UPC-E	
transmit check digit	5-33
UPC/EAN	
bookland EAN	5-30
convert EAN-8 to EAN-13 type	5-40
convert UPC-E to UPC-A	5-37, 5-38
coupon code	5-43
EAN zero extend	5-39
EAN-8/EAN-13	5-29
enable/disable	5-28
security level	5-41, 5-42
supplemental redundancy	5-32
supplementals	5-31
UPC-A preamble	5-34
UPC-E preamble	5-35
UPC-E1 preamble	5-36
battery	1-2
battery charge	2-8, 2-9, 4-8
battery temperature range message	D-1
changing	2-10
changing/replacing	2-10
charging	2-9
checking battery charge level	3-14
beeper	
beeper indications	4-8
beeper operation	4-5
beeper tone	5-18
beeper volume	5-19
boot up the scanner	3-1, 3-27
bullets	x
<b>C</b>	
carriage return	3-17, 3-18
charge status indicator light	1-2
charge status LED indications	2-10
charging the battery	2-8, D-1
code identifier	A-3
co-existence	
phaser-to-phaser	2-8
Spectrum24	2-7
communication protocol	3-2, 3-8, 5-8
MCL-Net	3-8, 5-8, 5-9, 5-97
RS232	2-2, 3-8, 5-8, 5-10, 5-83
scan & transmit app	3-2, 3-8, 5-2, 5-8
Synapse	2-3, 3-8, 5-8
connecting to a host	2-1
conventions	
notational	ix
cradle	1-2, 2-1
charging in the cradle	2-9
description of basic operation	1-2, 2-10
LED indicator status	2-10
pin outs	4-7
setting up the cradle	2-1, 2-6, 2-7
<b>D</b>	
data formatting	3-17
dead zone	3-23
decode depth of field	3-24
decode options	5-23
decode symbologies/capability	4-5
Default Application	3-1
Scan and Transmit Application	3-2, 5-8
default settings	5-2
resetting default application	3-10
resetting default scanning parameter	5-7
table of default parameters	5-2
default table	5-2
depth of field/decode zone	3-24
Dimensions	4-6
downloading	



ADF rules	3-17
applications	3-9
automatic upgrade process	B-1
durability	4-5

**E**

eliminating repetitive scanning	3-4
ENABLE UPC-E1	5-28
error beep sequences	4-8
error codes	3-5, 4-8, D-2
error messages and codes	D-1
Exit System Menu	3-16

**F**

firmware version	3-7, 3-15
formatting data	3-17

**H**

hardware handshaking	5-88
humidity	4-5

**I**

information, service	x
instructions	
quick startup	1-3
introduction	1-1

**K**

keypad	
access the system menu	3-7
alpha data entry	3-3
enabling/disabling the keypad	3-26
entering a blank space	3-27
a dash	3-27
a decimal point	3-27
example keying in data	3-27
manually resetting the scanner	3-1, 4-2
numeric data entry	3-2
operation and layout	3-26
quantity entry	3-4

**L**

laser classification	4-6
LED status on cradle	2-10
loading	
loading base station code	3-13
loading new applications	3-9
loading system code	3-12

**M**

maintenance	4-1
Manual Data Entry	
alpha data	3-3, 3-26
decimal points	3-27
example keying in data	3-26
numeric data	3-3
maximum tilt angles	3-23
MCL Net	3-8, 5-8
baud rate	5-6, 5-97, 5-98
frame timeout	5-6, 5-100
hex addressing mode	5-6, 5-99
parameters	5-97
scanner address	5-6
transmit retries	5-6, 5-100
messages	D-1

**N**

notational conventions	ix
numeric bar codes	5-104, 5-105
numeric data entry	3-2, 3-26

**O**

Operational parameters	5-1
------------------------	-----

**P**

P370 ALR (see ALR)	5-102
pairing long range scanners	2-6
pairing the scanner and cradle	2-6
parameters	
clear an ADF rule	3-17
reset default application	3-10
set all defaults	5-7

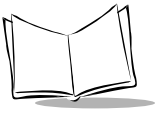

- table of default settings ..... 5-2
- pause duration ..... 5-82
- pin outs
  - cradle ..... 4-7
- pitch ..... 4-5
- Power Detect Beep ..... 5-20
- print contrast minimum ..... 4-5

**Q**

- quick startup instructions ..... 1-3

**R**

- reboot scanner ..... 3-1, 4-2
- Related Publication ..... x
- resetting the scanner ..... 3-1, 4-2
- Returns to Application ..... 3-16
- RF
  - optimizing RF performance ..... 2-7
  - pairing scanner to cradle ..... 2-6
  - RF channel ..... 3-8, 5-13, C-1
  - RF communication errors ..... 3-5, D-1
  - RF retries ..... 2-8, 5-13
- roll tolerance ..... 4-5
- RS-232C ..... 2-2, 3-8, 5-8, 5-10
  - ASCII format ..... 5-96
  - baud rate ..... 5-83, 5-84
  - check receive errors ..... 5-87
  - hardware handshaking . . . 5-88, 5-89, 5-90
  - host serial response time-out ..... 5-94
  - host types ..... 5-9
  - intercharacter delay ..... 5-96
  - parity ..... 5-85, 5-86
  - RTS line state ..... 5-94
  - software handshaking . . . 5-91, 5-92, 5-93
  - stop bit select ..... 5-95

**S**

- Scan and Transmit Application ..... 3-2
  - communication protocol . 3-2, 3-8, 5-2, 5-8
  - manual alphanumeric entry ..... 3-2, 3-3
  - quantity entry ..... 3-2, 3-4
- scan repetition rate ..... 4-5

- scanner address ..... 5-100
- Scanner Decode Beep Type ..... 5-101
- scanner decode beep type ..... 5-101
- scanner emits transmit errors ..... 4-3
- scanner ID ..... 3-8, 5-100
- Scanning ..... 3-2
  - scanning
    - eliminating repetition ..... 3-4
  - service information ..... x
  - set defaults
    - clearing ADF rules ..... 3-17
    - default application ..... 3-10
    - default scanning parameters ..... 5-7
  - set length
    - codabar ..... 5-70
    - code 39 ..... 5-50
    - code 93 ..... 5-58
    - discrete 2 of 5 ..... 5-67
    - interleaved 2 of 5 ..... 5-61
    - MSI Plessey ..... 5-75
- Set Scanner ID ..... 3-8
- setup
  - quick startup instructions ..... 1-3
- sleep time ..... 5-15
- software version
  - see firmware version ..... 3-7, 3-15
- spare pairing bar code ..... 2-6
- specular reflection ..... 3-23
- stay awake ..... 5-15
- suffix values
  - Enter (carriage return) ..... 3-18
  - Tab ..... 3-20
- symbol code identifier characters ..... A-6
- symbol support center ..... xi
- Synapse connectivity ..... 2-3, 3-8, 5-8
- system code
  - bar code ..... 3-12
- system menu ..... 3-7
  - accessing ..... 3-7
  - Back To Main ..... 3-8, 3-13, 3-14
  - Battery Check ..... 3-14
  - exiting system menu ..... 3-16
  - load new application ..... 3-9
  - navigating the system menu ..... 3-7

- Set Contrast ..... 3-8
- set default application ..... 3-10
- Set Default Params ..... 3-14
- set RF channel ..... 3-8
- version ..... 3-7, 3-15

**T**

- tab ..... 3-20
- technical specifications ..... 4-5
- temperature
  - battery ..... D-1
  - operating ..... 4-5
  - storage ..... 4-5
- transmit code ID character ..... 5-80, 5-81
- trigger pull to scan ..... 5-102
- trigger release to scan ..... 5-103
- troubleshooting ..... 4-2
  - messages and error codes ..... D-1

**U**

- UCC/EAN-128 ..... A-1
- unit cradled message ..... 2-9, D-1
- unpacking ..... 2-1

**V**

- version ..... 3-7, 3-15

**W**

- wake up ..... 3-2
- working range ..... 3-24

**Y**

- yaw ..... 4-5

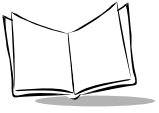

*P470/370 RF Scanner Product Reference Guide*

# ***Tell Us What You Think...***

We'd like to know what you think about this Manual. Please take a moment to fill out this questionnaire and fax this form to: (631) 738-3318, or mail to:

Symbol Technologies, Inc.  
One Symbol Plaza M/S B-4  
Holtsville, NY 11742-1300  
Attention: Technical Publications Manager

**IMPORTANT:** If you need product support, please call the appropriate customer support number provided. Unfortunately, we cannot provide customer support at the fax number above.

User's Manual Title: \_\_\_\_\_  
(please include revision level)

How familiar were you with this product before using this manual?

Very familiar     Slightly familiar     Not at all familiar

Did this manual meet your needs? If not, please explain.

---

---

What topics need to be added to the index, if applicable?

---

---

What topics do you feel need to be better discussed? Please be specific.

---

---

What can we do to further improve our manuals?

---

---

Thank you for your input—We value your comments.





# Quick Startup Instructions

Below is an index of Quick Startup Instructions to help get you up and going quickly. The index is listed in a step by step order beginning with step 1, Setting up the System.

Mandatory steps are designated by an asterisk (\*). If an item has multiple pages referenced, the most important reference is in bold.

	<b>PRG Page</b>
<b>1. Setting Up the System</b>	
• Connecting the cradle to a host *	2-1
- RS-232 connection	2-2
- Synapse connection (keyboard wedge, USB, etc.)	2-3
• Charging the battery *	1-2, <b>2-8</b>
• Pairing the scanner with the cradle *	2-6
- RF channel	<b>3-8</b> , 5-13, C-1
- Coexisting in Spectrum24 environments	2-7
<b>2. Using the Default Applications</b>	
• Overview of Scan and Transmit application*	3-2
• Keypad operation	3-2, 3-3, <b>3-26</b>
• Eliminating repetitive scanning	3-4
• Selecting the host communication protocol	3-2, 3-8, <b>5-8</b>
- RS-232 baud rate	5-83
<b>3. Programming an Advanced Data Formatting Rule Using 123Scan</b>	
• Suffix values (appending Enter key and Tab)	3-17
• Suffix values (appending Enter key and Tab)	<b>3-18</b>
<b>4. Troubleshooting Problems</b>	
• Troubleshooting table	4-2
• Communication errors	3-5, <b>D-2</b>
• Beeper indications and default application error codes	4-8
• Cradle LED indications	2-10



72-38495-03

Revision C — December 2003