

MO'PHATT

64-VOICE URBAN DANCE SYNTH

Operation Manual

©2000, E-MU Systems, Inc. d.b.a. E-MU / ENSONIQ. All rights reserved.

FI10721 Rev. B

E-MU World Headquarters

E-MU / ENSONIQ

P.O. Box 660015

Scotts Valley, CA USA

95067-0015

Telephone: 831-438-1921

Fax: 831-438-8612

Internet: www.emu.com

Europe, Africa, Middle East

E-MU / ENSONIQ

Suite 6, Adam Ferguson House

Eskmills Industrial Park

Musselburgh, East Lothian

Scotland, EH21 7PQ

Tel: +44 (0) 131-653-6556

Fax: +44 (0) 131-665-0473

The following are registered worldwide trademarks owned and/or exclusively licensed by E-MU Systems, Inc.: E-MU® and E-MU Systems®. All other trademarks are the property of their respective holders.

Important Notice:

In order to obtain warranty service on your Mo'Phatt unit, the serial number sticker must be intact and you must have a sales receipt or other proof of purchase. If there is no serial number sticker on the Mo'Phatt, please contact E-MU Systems at once.

This product is covered under one or more of the following U.S. patents: 4,404,529; 4,506,579; 4,699,038; 4,987,600; 5,013,105; 5,072,645; 5,111,727; 5,144,676; 5,170,367; 5,248,845; 5,303,309; 5,317,104; 5,342,990; 5,430,244 and foreign patents and/or pending patents. All other trademarks belong to their respective companies. Specifications and features are subject to change without notice.

Table of Contents

Introduction	1
Product Description	1
Overview	2
Important Safety Instructions - English	3
Foreign Language Warnings - German	6
Foreign Language Warnings - French	9
Setup	13
Unpacking	13
Connection Instructions	14
Basic Setup	14
Studio Setup	15
Power Up!	16
Instant Gratification	17
Playing Demo Sequences	17
Auditioning Presets	17
Selecting and Quick Editing Presets	18
Playing BEATS	20
Exploring the Master Arpeggiator	22
Multi-Channel Arpeggiator	23
Basic Operations	25
Front Panel	25
Volume Control	25
Master Button	25
Edit Button	25
Control Button	25
Audition Button	26
Left/Right Cursor Buttons	26
Save/Copy Button	26
Home/Enter Button	26
Data Entry Control	27

Front Panel Controller Modes.....	27
Real-time Control	27
Quick Edit	28
Deep Edit Mode	28
Main Screen.....	30
MIDI Channel Selection	30
Preset Selection	30
Channel Volume	31
Channel Pan	32
Channel Arpeggiator	32
Sound Navigator.....	33
Preset Category	33
Instrument Category	33
Multitimbral Operation	34
Arpeggiator/Beats Menu	35
Base Tempo (Master Clock)	36
SuperBEATS.....	36
BEATS Mode	39
Status	39
Beats Channel (BtsCh)	39
Trigger Channel (TrigCh)	39
BEATS Controllers	41
Beat Velocity Group 1-4 (BtsVelG1 -> BtsVelG4)	41
Beat Xpose Group 1-4 (BtsXpsG1 -> BtsXpsG4)	41
Beat Busy (BtsBusy)	41
Beat Variation	42
Beat Variation (BtsVari)	42
Beats Trigger Layout	43
1-Bar Trigger Option	43
Beats Trigger Offset	44
Beats Part Velocity	44
Beats Part Transpose	45
Beats Part Group	46
Master Riff	46
Riff Tempo	47
Riff Controllers	47
MIDI Song Start	48
Arp/Riff MIDI Out	48
Arpeggiators	49
Arp Controllers	50
Master Arpeggiator Parameters	50
Status	51
Mode	51
Note Value	52
Arpeggiator Pattern Speed	52

Table of Contents

Pattern	52
Velocity	53
Gate Time	53
Extension Count	54
Extension Interval	54
Sync	55
Pre-Delay	55
Duration	56
Post-Delay	56
Recycle	57
Keyboard Thru	57
Latch	57
Key Range	58
Send MIDI System Exclusive Data	58
User Patterns	58
Editing a User Arpeggiator Pattern	59
Pattern Step Number	59
Key	59
Key Offset	60
Tie	60
Rest	60
Skip	60
End	60
Velocity	61
Duration	61
Repeat	61
User Pattern Name	62
Multi-Channel Arpeggiating.....	63
Using a MIDI Interface to Channelize Data.....	64
Master Menu	65
Defining Master Parameters	66
Transpose/Tune	66
Bend Range	66
Velocity Curve	67
Mix Output	67
Master Effects	69
Effects Mode	69
Effects Multi Mode Control	69
Master FXA Algorithm	70
A Effect Types	70
FXA Parameters: Decay/HF Damping FxB -> FxA	71
FXA Send Amounts	71
Master FXB Algorithm	71
B Effect Types	72
FXB Parameters: Feedback/LFO Rate Delay Time	72
FXB Send Amounts	72

MIDI Parameters	73
MIDI Mode	73
MIDI SysEx ID	73
MIDI Enable	74
MIDI Program Change -> Preset	74
Receive Program Change	75
Real-time Controller Assignment	75
MIDI Footswitch Assign	76
Tempo Controller	77
Knob Preset Quick-Edit	77
Knobs Deep Edit	78
Knobs/Riff MIDI Out	78
Preset Edit All Layers Enable	78
Front Panel Knob Calibration	79
MIDI SysEx Packet Delay	80
Send MIDI System Exclusive Data	80
User Key Tuning	82
Screen Viewing Angle	82
Programming Basics	83
Modulation	84
Modulation Sources	85
Random Sources	86
Modulation PatchCords.....	86
Envelope Generators	87
Tempo-based Envelopes	88
Envelope Repeat	88
Low Frequency Oscillators (LFOs).....	89
Clock Modulation.....	90
Modulation Destinations	92
Modulation Processors	93
Preset Modulation Processors	95
Using the Modulation Processors	97
More Examples	99
Dynamic Filters	101
What is a Filter?	102
Parametric Filters	105
The Z-Plane Filter	106
Signal Flow	107
MIDI Channels & Real-time Controls.....	108
Bank Select Commands	110
Stereo Mix Outputs.....	111

Table of Contents

Edit Menu	113
Preset Name	114
Four Layer Architecture	115
Selecting Layers	115
Defining Layer Parameters	116
Selecting an Instrument	116
Sound Navigator	116
Defining Key Range	117
Defining the Velocity Crossfade Range	120
Defining the Real-time Crossfade Range	122
Transposing the Instrument	125
Tuning	126
Background: Transpose vs. Coarse Tuning	126
Amplifier	126
Volume Envelope	127
Selecting the Mode	127
Defining the Volume Envelope	128
Chorusing the Layer	129
Sound Start Offset and Delay	129
Non-Transpose Mode	130
Solo Mode	130
Assign Group	131
Glide	132
Z-Plane Filters	132
Mo'Phatt Filter Types	133
Filter Types	133
Filter Parameters	135
Filter Envelope	135
Defining the Filter Envelope	137
Auxiliary Envelope	137
Low Frequency Oscillators (LFOs)	137
Shape	138
Sync	139
Rate	139
Delay	140
Variation	141
PatchCords	142
Modulator Polarity	143
Pitch Bend Range	145
Mix Output	145
Common Preset Parameters	146
Preset Effects	146
FXA Algorithm	148
A Effect Types	148
FXA Parameters	149
FXA Send Amounts	149
FXB Algorithm	149
B Effect Types	149

FXB Parameters	150
FXB Send Amounts	150
Preset Patchcords	151
Initial Controller Amount	152
Keyboard Tuning	153
Preset Links	155
Preset Tempo Offset	156
Audition Riff Selection	156
Play Solo Layers	156
Programming Tutorial	157
Editing Presets.....	157
Changing the Instrument	157
Changing the Tuning of an Instrument	158
Chorus	159
Volume Envelope	159
Working with Filters	161
Adding the Filter Envelope	162
Changing Filter Types	164
Envelope Repeat	165
Practice Modulating	165
Troubleshooting	166
Linking Presets.....	167
Effects	169
Effects Overview.....	169
The Effects Sends	169
Effect Types.....	171
Effect Parameters	171
Decay	172
High Frequency Damping	172
Feedback	172
LFO Rate	172
Delay	172
Effects Programmed in the Preset.....	173
Master Effects.....	174
Effects Mode	176
Using the Effects Channel Settings in Multi Mode	178
Effect B Into Effect A	178
General Effect Descriptions.....	180
Reverb	180
Chorus	181
Doubling	181
Slapback	181
Stereo Flanger	181

Table of Contents

Delay	182
Stereo Delay	182
Panning Delay	182
Dual Tap	182
Vibrato	182
Distortion	182
Save/Copy Menu	183
Saving a Preset.....	183
Copying Information	184
Copy Preset	184
Copy Layer	185
Copy PatchCords	186
Copy Preset PatchCords	186
Copy Arpeggiator Settings	187
Copy Arpeggiator Pattern	187
Copy Preset Bank	188
Multisetups.....	188
Restoring Multisetups	189
Multisetup Name	189
Saving Multisetups	190
Create Random Preset	190
Copy User Bank to Flash	191
Rename Flash SIMM	192
Duplicate Flash	193
Appendix.....	195
Front Panel Knob Functions	195
Presets	196
Preset Categories	196
Preset Listing.....	197
Instrument Listing.....	201
Riff Listing.....	210
Example Percussion Maps	213
Trigger Layouts	216
Velocity Curves	219
PatchCord Amount Chart	221
MIDI	222
Technical Specifications.....	225
Props	226
Warranty.....	227
Index	229

Introduction

Product Description

Congratulations on your purchase of the Mo'Phatt, 64-Voice Urban Dance Module. Mo-Phatt takes over where E-MU's legendary Planet Phatt left off with 32 MB of fresh new sounds and lightning fast response time. Mo'Phatt was designed for *performance*, so make sure to try out all the controller knobs on each preset.

Mo'Phatt contains two user-upgradable sound SIMM sockets. Need more sounds? New sounds can be added as easily as plugging in a new 16MB or 32MB SIMM module. Many sets are available now, with more coming all the time, or you can create your own custom ROMs using E-MU's E4 Ultra samplers.

Mo'Phatt contains 512 user presets and can hold literally thousands of factory presets. *(ROM presets are automatically added when sound SIMMs are installed. As an example, a 32 MB SIMM may contain up to 1024 ROM presets.)* Mo'Phatt's Sound Navigator makes it easy to find the exact sound you want. It's powerful, yet simple to use.

Mo'Phatt contains E-MU's new SuperBEATS Mode, which is a whole new way to create dynamic, original music. With SuperBEATS, you trigger, latch and unlatch synced loops and grooves from your keyboard. Simply select a "bts:" preset and you're ready to groove! Then use Mo'Phatt's performance controls to alter and mutate the rhythm or the sound itself.

Then there's Mo'Phatt's revolutionary Rhythmic Pattern Generator/Arpeggiator which can play up to 16 synchronized arpeggiator patterns at once using a different sound for each! Patterns can be edited using pattern flow commands such as: delay for 2 bars, play for 4 bars, hold for 2 beats and repeat. You can program or download 100 user patterns in addition to the 200 factory patterns.

The extremely flexible yet easy to use 4-layer synthesizer voices make it easy to build sounds of any kind. Layers can be switched or crossfaded using key position, velocity, real-time controllers or any modulation source. Mo'Phatt also contains 50 different 2nd to 12th order resonant & modeling

filters which are used to shape and modify the waveforms contained in 32 megabytes (MB) of ROM.

Sixty four modulation sources include three multistage envelopes and two LFOs per layer, as well as full MIDI control over virtually every parameter. The digital patch bay, with 24 cords per layer, (and 12 more cords per preset) lets you connect modulation sources to 64 destinations in any imaginable way. The patch bay contains a set of arithmetic modifiers, letting you create complex synthesis models. Synth parameters as well as arpeggiator and BEAT tempos can be controlled from Mo'Phatt's internal clock (or an external MIDI clock). Up to 8 LFOs and 12 envelopes can be perfectly synchronized at different rates. This is an extremely powerful synthesizer!

Four front panel real-time controllers give you control over 12 user-selectable parameters. The real-time knobs can adjust multiple parameters at once, allowing complex levels of control. For example, one knob can simultaneously turn up filter cutoff, while detuning one sample, and adjusting the release time of the volume envelope. Virtually every synth parameter in Mo'Phatt is controllable using the real-time knobs or by any internal or external control source.



The optional Turbo upgrade adds the following features to your Mo'Phatt:

- 128 voice polyphony
- 4 submix analog outputs
- 32 MIDI channel operation
- 2 additional sound ROM slots
- S/PDIF stereo digital output

Once you have created your preset, you can add richness to your sound using Mo'Phatt's 24-bit stereo effects. You can choose a different effects setup for each preset from over 60 algorithms. Mo'Phatt's effects section is actually two separate effects processors with control over each wet/dry mix level on four effects sends. Effects Processor "A" contains primarily ambiance algorithms like reverb and delays, while effects processor "B" contains primarily spectral algorithms such as chorus, flange, phase, distortion, and delay. Effects can be linked to each preset or used globally to further enhance your sound.

Other features include multiple solo, voice assignment and performance modes for expressive control, 12 user-definable alternate tunings, and, of course, an extensive MIDI implementation.

Overview

This is the Getting Started Manual for setting up and playing Mo'Phatt. The first part of the manual describes how to unpack and setup the hardware. The next chapters provide step-by-step instructions for the most common and widely used features of Mo'Phatt. This section also defines each of the parameters and provides information on how to use them.

The complete operation manual is provided to you in pdf format on CD-ROM. The CD-ROM contains pdf files for both Mac and PC as well as the complete MIDI SysEx specification and a software downloading tool which allows you to retrieve the latest software and new features from the world wide web.

Important Safety Instructions

Grounding Instructions

Use in countries other than the U.S.A. may require the use of a different line cord or attachment plug, or both. To reduce the risk of fire or electric shock, refer all servicing to qualified service personnel. Do not expose this product to rain or moisture. There are no user serviceable parts or adjustments inside the unit.

This product must be grounded. If it should malfunction or break down, grounding provides a path of least resistance for electric current, reducing the risk of electric shock. This product is equipped with a cord having an equipment-grounding conductor and a grounding plug. The plug must be plugged into an appropriate outlet properly installed and grounded in accordance with all local codes and ordinances.

Danger!

Improper connection of the equipment's grounding conductor can result in the risk of electric shock. Check with a qualified electrician or service personnel if you are in doubt as to whether the product is properly grounded. Do not modify the plug provided with this product. If it will not fit the outlet, have a proper outlet installed by a qualified technician.

Caution!

If your Mo'Phatt (Model Number 9111) is rack mounted, you must use a standard 19 inch open frame rack. Screw-on rack mount ears are provided for this purpose.

User Maintenance Instructions



This symbol is intended to alert you to the presence of important operating and maintenance (servicing) instructions in the literature accompanying the unit.

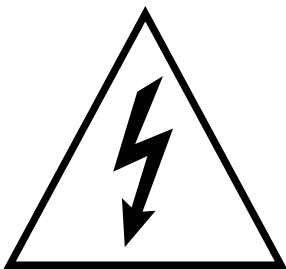

This symbol is intended to alert you to the presence of uninsulated dangerous voltage within the product's enclosure that may be of sufficient magnitude to constitute a risk of electric shock to persons.

1. The Mo'Phatt should be kept clean and dust free. Periodically wipe the unit with a clean, lint free cloth. Do not use solvents or cleaners.
2. There are no user lubrication or adjustment requirements.

Caution -. *These servicing instructions are for use by qualified personnel only. To reduce the risk of electric shock, do not perform any servicing other than that contained in these operating instructions unless you are qualified to do so. Refer all servicing to qualified service personnel.*

INSTRUCTIONS PERTAINING TO A RISK OF FIRE, ELECTRIC SHOCK, OR INJURY TO PERSONS.

READ THESE INSTRUCTIONS: When using electric products, basic precautions should always be adhered to, including the following:

1. Read all instructions before using Mo'Phatt.
2. To reduce the risk of injury, close supervision is necessary when using Mo'Phatt near children.
3. Do not use Mo'Phatt near water — for example near a bathtub, washbowl, kitchen sink, in a wet basement, on a wet bar, or near or in a swimming pool. Do not expose the unit to drips or splashes.
4. The Mo'Phatt should be situated so that its location or position does not interfere with its proper ventilation.
5. The Mo'Phatt should be located away from heat sources such as radiators, heat registers, fireplaces, stoves, or ovens.
6. The Mo'Phatt should be connected only to a power supply of the type described in the operating instructions and marked on the product.
7. Care should be taken so that objects do not fall and liquids are not spilled into the enclosure of Mo'Phatt through openings.
8. This Mo'Phatt may be equipped with a polarized line plug (one blade wider than the other). This is a safety feature. If you are unable to insert this plug into the outlet, do not defeat the safety purpose of the plug. Contact an electrician to replace your obsolete outlet.
9. Protect the power cord from being walked on or pinched, particularly at plugs, convenience receptacles, and the point where they exit from the unit.
10. Unplug the Mo'Phatt from the power outlet during lightning storms or when left unused for a long period of time.
11. This product, in combination with an amplifier and headphones and speakers, may be capable of producing sound levels that could cause permanent hearing loss. Do not operate for a long period of time at a high volume level or at a level that is uncomfortable. If you experience any hearing loss or ringing in the ears, consult an audiologist.
12. Only use attachments and accessories specified by E-mu Systems.
13. The Mo'Phatt should be serviced by qualified service personnel when:

Radio and Television Interference

- A. The power supply cord has been damaged; or
 - B. Objects have fallen, or liquid has been spilled into the unit; or
 - C. The unit has been exposed to rain; or
 - D. The unit has been dropped or the enclosure damaged; or
 - E. The Mo'Phatt does not operate normally or exhibits a marked change in performance.
14. All servicing should be referred to qualified service personnel.

Save These Instructions.

The equipment described in this manual generates and uses radio-frequency energy. If it is not installed and used properly—that is, in strict accordance with our instructions—it may cause interference with radio and television reception.

This equipment has been tested and complies with the limits for a Class B computing device in accordance with the specifications in Subpart J of Part 15 of the FCC rules. These rules are designed to provide reasonable protection against such interference in a residential installation. However, there is no guarantee that the interference will not occur in a particular installation, especially if a “rabbit ear” TV antenna is used.

If Mo'Phatt does cause interference to radio or television reception, you can try to correct the interference by using one or more of the following measures:

- Turn the television or radio antenna until the interference stops.
- Move Mo'Phatt to one side or the other of the television or radio.
- Move Mo'Phatt farther away from the television or radio.
- Plug Mo'Phatt into an outlet on a different circuit than the television or radio.
- Consider installing a rooftop antenna with a coaxial lead-in between the antenna and television set.

Foreign Language Warnings **- German**

Wichtige Sicherheits- vorschriften

In Ländern ausserhalb den U.S.A. können andere Kabel oder Stecker notwendig werden. Zur Verminderung des Risikos von Feuer oder eines elektrischen Schlages übergebe man den Service an qualifizierte Fachleute. Das Gerät niemals Regen oder Nässe aussetzen.

Erdungs- struktionen

Das Gerät muss geerdet sein. Bei einem Defekt oder Ausfall bietet Erdung dem elektrischen Strom den Weg des geringsten Widerstandes und reduziert das Risiko eines Schlages. Dieses Gerät ist mit einem geerdeten Kabel und Stecker ausgerüstet. Der Stecker muss in eine passende, einwandfrei montierte und geerdete Steckdose in Übereinstimmung mit den örtlichen Vorschriften eingeführt werden.

Gefahr

Unvorschriftsgemässer Anschluss des Gerätes kann zum Risiko eines elektrischen Schlages führen. Im Zweifelsfalle über die ordnungsgemässe Erdung soll ein qualifizierter Elektriker oder eine Serviceestelle beigezogen werden. Ändern Sie den mitgelieferten Stecker nicht. Sollte er nicht in die Steckdose passen, soll die einwandfreie Installation durch einen qualifizierten Techniker erfolgen.

Vorsicht

Wird der Mo'Phatt (Modell Nummer 9111) in einem Rackgestell montiert, muss ein offener 19-Zollrahmen verwendet werden.

Unterhaltsinstruktionen für anwender

Vorsicht



Dieses Symbol weist den Anwender auf wichtige Gebrauchs- und Servicevorschriften in den beiliegenden Drucksachen.

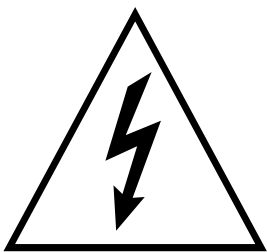

Dieses Symbol verweist auf nicht-isolierte Stromspannungen im Geräte-Innern, welche zu einem elektrischen Schlag führen könnten.

1. Mo'Phatt soll sauber und staubfrei gehalten werden. Das Gerät mit einem sauberen und säurefreien Tuch periodisch abreiben. Keine Lösungs- oder Reinigungsmittel anwenden.
2. Schmieren und Justieren sind nicht notwendig.
3. Bei weiteren Servicefragen wende man sich an eine qualifizierte Servicestelle.

Diese Gebrauchsanweisungen sind nur für qualifizierte Techniker beabsichtigt. Um die Gefahr eines elektrischen Schlages zu vermeiden, sollen Sie keine Arbeit unternehmen, die nicht in diesen Instruktionen vorgeschrieben ist. Wenden Sie sich bei weiteren Servicefragen an eine qualifizierte Servicestelle.

INSTRUKTIONEN BETR. FEUERRISIKO, ELEKTROSCHOCK ODER VERLETZUNG VON PERSONEN

WARNUNG; Beim Einsatz elektrischer Geräte sollten folgende Vorsichtsmassregeln stets beachtet werden:

1. Lesen Sie vor dem Einschalten des Mo'Phatt alle Instruktionen.
2. Zur Vermeidung von Verletzungsrisiken müssen Kinder bei eingeschaltetem Mo'Phatt sorgfältig überwacht werden.
3. Mo'Phatt nicht in der Nähe von Wasser in Betrieb nehmen -- z.B. in der Nähe von Badewannen, Waschschüsseln, auf nassen Gestellen oder am Swimmingpool.
4. Mo'Phatt stets so aufstellen, dass seine Belüftung nicht beeinträchtigt wird.
5. Mo'Phatt nicht in der Nähe von Hitze aufstellen, wie Heizkörper, offenem Feuer, Öfen oder von Backöfen.
6. Mo'Phatt ausschliesslich mit einem Netzgerät gemäss Bedienungsanleitung und Gerätemarkierung verwenden.
7. Dieses Gerät kann bei Verwendung von Kopfhörern und Verstärkern hohe Lautpegel erzeugen, welche zu bleibenden Gehörschäden führen. Arbeiten Sie nicht während längerer Zeit mit voller Lautstärke oder hohem Lautpegel. Stellen Sie Hörverlust oder Ohrenläuten fest, wenden Sie sich an einen Ohrenarzt.
8. Mo'Phatt kann mit einem polarisierten Kabelstecker (mit ungleichen Stiften) ausgerüstet sein. Das geschieht für Ihre Sicherheit. Können Sie den Stecker nicht in die Steckdose einführen, ändern Sie nicht den Stecker ab, sondern wenden Sie sich an einen Elektriker.
9. Das Netzkabel des Mo'Phatt bei längerem Nichtgebrauch aus der Steckdose ziehen.

10. Vermeiden Sie sorgfältig das Eindringen von Gegenständen oder Flüssigkeiten durch die Gehäuseöffnungen.
11. Das Gerät soll durch qualifizierte Serviceleute gewartet werden, falls:
 - A. das Netzkabel beschädigt wurde, oder
 - B. Gegenstände oder Flüssigkeit in das Gerät gelangten,
 - C. das Gerät Regen ausgesetzt war, oder
 - D. das Gerät nicht normal oder einwandfrei arbeitet, oder
 - E. das Gerät stürzte oder sein Gehäuse beschädigt wurde.
12. Servicearbeiten sollten nur qualifizierten Fachleuten anvertraut werden.

DIESE INSTRUKTIONEN AUFBEWAHREN

Foreign Language Warnings **- French**

Instructions de Sécurité Importantes

Une utilisation dans des pays autres que les U.S.A. peut nécessiter l'usage d'un cordon d'alimentation différent. Afin de réduire les risques d'incendie ou d'électrocution, référez-vous à un personnel de service qualifié, et n'exposez pas cet appareil à la pluie ou à l'humidité.

Instructions de Mise à la Terre

Cet appareil doit être relié à la terre. Dans le cas d'une malfonction éventuelle, la terre fournit un passage de moindre résistance pour le courant électrique, réduisant ainsi les risques d'électrocution. Le Mo'Phatt est équipé d'un cordon muni d'un conducteur et d'une fiche devant être branchée dans une prise appropriée et reliée à la terre en conformité avec les normes locales.

Danger

Une connexion incorrecte peut résulter en des risques d'électrocution. Vérifiez avec un technicien qualifié si vous avez des doutes quant à la connexion. Ne modifiez pas vous-même le cordon d'alimentation livré avec cet appareil; s'il ne rentre pas dans la prise, faites-en installer un autre par un technicien qualifié.

Attention

Si le Mo'Phatt (Model 9111) est installé dans un rack, utilisez un rack standard ouvert de 48.25cm.

Instructions de Maintenance

1. le Mo'Phatt doit être maintenu propre et sans poussière. Nettoyez-le périodiquement à l'aide d'un chiffon propre et non-pelucheux. N'utilisez pas de solvants, ou d'autres produits de nettoyage.
2. Aucune lubrification et aucun réglage ne sont nécessaires de votre part.
3. Pour tout autre service, référez-vous à un personnel qualifié.

Instructions Concernant les Risques d'Incendie, d'Électrocution, ou de Blessures Corporelles.

ATTENTION: Lorsque vous utilisez des appareils électriques, certaines précautions élémentaires doivent toujours être prises, incluant les suivantes:

Ces instructions de dépannage sont destinées uniquement aux personnes qualifiées. Afin d'éviter les risques d'électrocution, n'effectuez que les opérations décrites dans ce manuel, à moins que vous ne soyez qualifié pour cela. Faites effectuer toute réparation par une personne qualifiée.



Ce symbole vous alerte de la présence d'instructions importantes d'opération et de maintenance dans la notice accompagnant l'appareil.

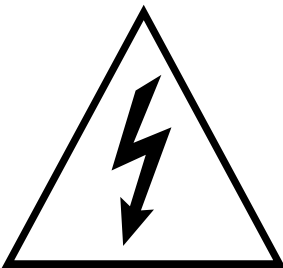

Ce symbole vous alerte de la présence d'un voltage non-isolé dangereux à l'intérieur de l'appareil, pouvant être d'une magnitude suffisante pour constituer un risque d'électrocution.

1. Lisez bien toutes les instructions avant d'utiliser le Mo'Phatt.
2. Afin de réduire les risques de blessures, une attention particulière est nécessaire en la présence d'enfants en bas âge.
3. N'utilisez pas le Mo'Phatt dans ou près d'endroits humides - par exemple près d'une baignoire, d'un lavabo, dans les toilettes, dans une cave humide, sur un bar fréquenté, en présence d'un bull-dog en rut, ou dans une piscine pleine. Protégez cet appareil de tout liquide, éclaboussure ou fuite.
4. Le Mo'Phatt doit être placé de façon à ce que sa position n'interfère pas avec sa propre ventilation.
5. Le Mo'Phatt doit être placé loin de sources de chaleur telles que des radiateurs, cheminées, fours, ou groupies en chaleur.
6. Le Mo'Phatt doit uniquement être connecté à une alimentation du type décrit dans les instructions d'opération et tel qu'indiqué sur l'appareil.
7. Une attention particulière doit être observée quant aux objets pouvant tomber et aux liquides pouvant être versés sur et à l'intérieur de le Mo'Phatt.
8. Le Mo'Phatt peut être équipé d'une fiche secteur polarisée (avec une broche plus large que l'autre). C'est une mesure de sécurité. Si vous ne pouvez pas brancher cette fiche dans une prise, ne neutralisez pas cette sécurité. Contactez plutôt un électricien pour remplacer la prise obsolète.
9. Evitez de marcher sur le cordon d'alimentation ou de le coincer, particulièrement près des prises de courant, des boîtiers électriques et du point de sortie de l'appareil.
10. Le cordon d'alimentation de le Mo'Phatt doit être débranché lorsque ce dernier n'est pas utilisé pendant une longue période.
11. Cet appareil, combiné avec un amplificateur, des haut-parleurs, et/ou un casque, est capable de générer des niveaux sonores pouvant occasionner une perte de l'ouïe permanente. Ne travaillez pas trop longtemps à un volume trop élevé ou même inconfortable. Si vous observez une perte de l'audition ou un bourdonnement dans les oreilles, consultez un O.R.L.
12. N'utilisez que les accessoires spécifiés par E-mu Systems.
13. Cet appareil doit être examiné par un personnel qualifié lorsque:

Interférences Radio et Télévision

- A. Le cordon d'alimentation a été endommagé, ou
 - B. Des objets sont tombés, ou du liquide a été versé sur/à l'intérieur de l'appareil, ou
 - C. Le Mo'Phatt a été exposé à la pluie, ou
 - D. Le Mo'Phatt est tombé, ou
 - E. Le Mo'Phatt ne fonctionne pas normalement, ou affiche un changement radical de performance.
14. Tout service doit être effectué par un personnel qualifié.

SAUVEGARDEZ CES INSTRUCTIONS

L'appareil décrit dans cette notice génère et utilise une énergie de fréquence-radio. S'il n'est pas installé et utilisé correctement - c'est à dire en suivant strictement nos instructions - il peut occasionner des interférences avec la réception d'une radio ou d'une télévision.

Cet appareil a été testé et est conforme aux normes de Classe A en accord avec les spécifications du paragraphe J de la section 15 des lois FCC. Ces lois sont désignées pour fournir une protection raisonnable contre de telles interférences dans une installation résidentielle. Toutefois, il n'est pas garanti qu'aucune interférence n'apparaisse dans des installations particulières, et plus spécialement lorsqu'une antenne de télévision en «oreilles de lapin» est utilisée.

Si le Mo'Phatt occasionne des interférences, vous pouvez essayer de les corriger en utilisant une ou plusieurs des mesures suivantes:

- Tournez l'antenne de la télé ou de la radio jusqu'à ce que les interférences disparaissent.
- Déplacez le Mo'Phatt d'un côté ou de l'autre de la télé ou de la radio.
- Eloignez le Mo'Phatt de la télé ou de la radio.
- Branchez le Mo'Phatt sur une prise différente que la télé ou la radio.
- Installez une antenne sur le toit munie d'une connexion coaxiale entre elle et le poste de télévision.

Declaration of Conformity



Manufacturer:

E-MU/Ensoniq
1600 Green Hills Road
Scotts Valley, CA 95067-0015 USA

We hereby declare that the equipment listed herein conforms to the harmonized standards of the following European Commission Directives: 89/336/EEC and 72/23/EEC.

Trade Name: Audio Sampler/Emulator System

Model Number: Proteus 1000 CR

Under 89/336/EEC as amended by 92/31/EEC, and 72/23/EEC

In accordance with EN 55103-1:1996, Emission Environments E1, E2, E3

In accordance with EN 55103-2:1996, Immunity Environments E1, E2, E3

Test information is contained in a report by Atlas Compliance and Engineering dated November 15, 1999.

Report No.: 9949EMU2KCR103

Under 73/23/EEC as amended by 93/68/EEC

In accordance with EN 60950 with amendments A1, A2, A3, A4, A11

This Declaration is made November 15, 1999

Setup

Unpacking

This section thoroughly describes how to set up your new Mo'Phatt for use. Setup includes unpacking instructions and how to connect the cables.

Carefully remove Mo'Phatt from the packaging material. Take care to save the packing materials in case you need to transport the unit. Check to make sure all components are included and in good condition. If there are missing or damaged components, contact E-MU Systems immediately for replacement or repair.

The Mo'Phatt box should include the following components:

- Mo'Phatt rack unit
- Power cable
- Rack mounting ears
- This operation manual
- Manuals CD-ROM

Connection Instructions

Basic Setup

 If Mo'Phatt does not seem to be responding correctly, make sure that both Mo'Phatt and your MIDI controller are set to the same MIDI channel.

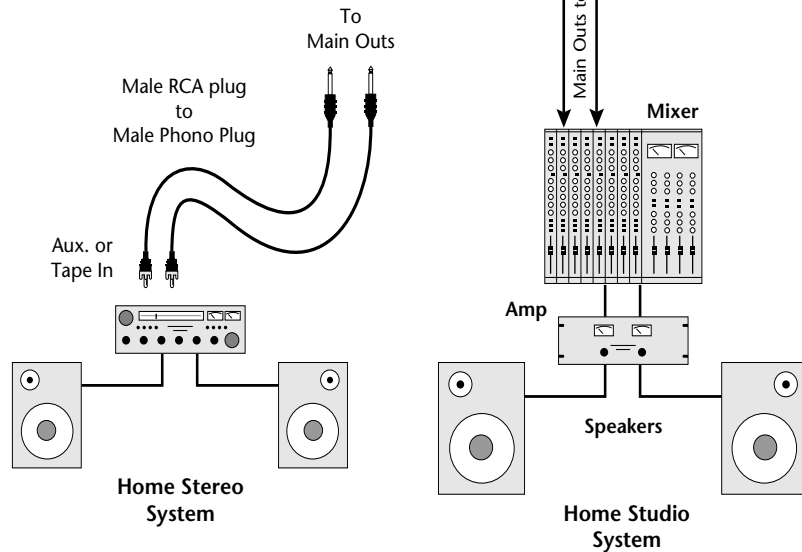
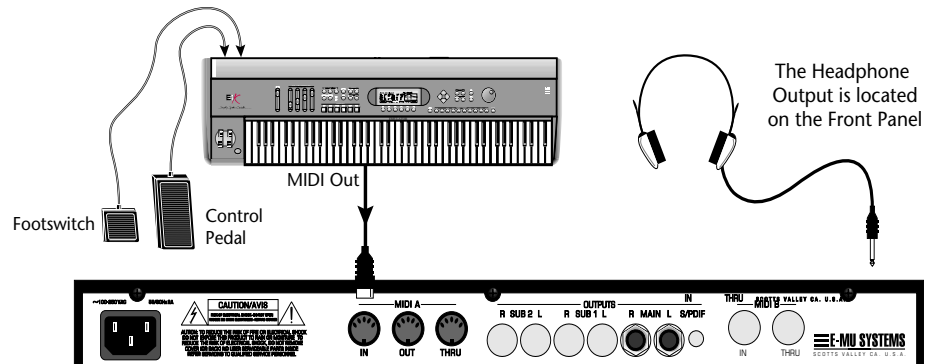

 The Right Main output jack carries a mono mix of the left and right channels when the Left Main plug is not plugged in.

The Left Main output jack is a stereo jack carrying both channels when the right output jack is empty.

MIDI In

Mo'Phatt is controlled by MIDI messages received at the MIDI In jack. Normally you will connect MIDI Out of a controller such as a MIDI keyboard to Mo'Phatt's MIDI In jack. Be sure to connect a Footswitch and/or Control Pedal to your MIDI keyboard. Many of the factory presets use MIDI controllers.

Outputs

In order to reproduce Mo'Phatt's wide dynamic range and frequency response, use a high quality amplification and speaker system such as a keyboard amplifier or home stereo system. A stereo setup is highly desirable because of the added realism of stereophonic sound. Headphones can be used if an amplifier and speaker system is not available. Plug stereo headphones into the headphone jack on the left side of the front panel.

Studio Setup

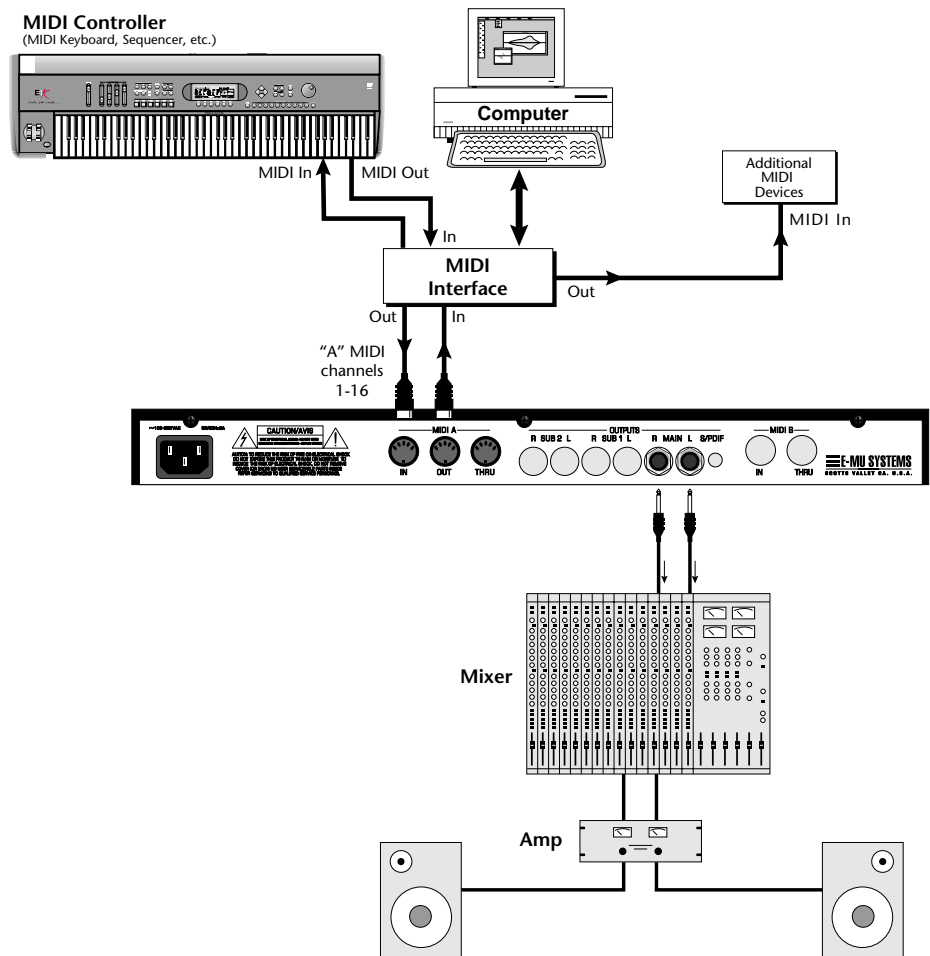

MIDI In

In this setup, Mo'Phatt is controlled by MIDI messages, received at the MIDI input, which are routed by the MIDI interface. The MIDI interface allows any MIDI controller, such as a MIDI keyboard or a computer, to control the module.

MIDI Out

The MIDI Out jack transmits program data to a computer or other device.

Outputs

A stereo connection is highly desirable because of the added realism of stereophonic sound. Plug stereo headphones into the headphone jack located on the left side of the front panel. The Right Main output jack serves as a mono output when the Left Main plug is not plugged in. The Left Main output jack is a stereo jack carrying both channels when the Right output jack is empty.

Power Up!

The power switch is located on the right side of the front panel. You can turn on the Mo'Phatt and its MIDI controller in any order. When power is applied the liquid crystal display will light, indicating that Mo'Phatt is operating. You may have noticed that there is no 110/220 Volt power selector switch on Mo'Phatt.

Mo'Phatt automatically switches itself to the proper line voltage.

Instant Gratification

Playing Demo Sequences

This section presents step-by-step instructions for the most fundamental operations to get you up and making sounds quickly.

Mo'Phatt has several factory demonstration sequences that let you hear what this incredible machine can do. The actual number of demo sequences depends on which ROM sounds sets are installed. You can play these demo sequences by accessing the Demo Sequence page.



► To Play a Demo Sequence

1. Press and hold the **Master** and **Edit** buttons at the same time to enter the Demo Sequence page. The screen shown above appears.
2. Select a sequence using the data entry control. The Enter LED will be flashing.
3. Press the Enter button to begin playing the selected sequence. The screen shown below appears.



4. Press the Enter button again to stop playing the sequence.
5. When a demo sequence plays to the end, the next demo will automatically begin playing. The screen will display the new demo name.
6. With the sequence stopped, press either the Master, Edit or Arp/Beats button to Exit the demo sequence mode.

Auditioning Presets

The front panel audition button allows you to hear any preset in Mo'Phatt without even hooking up a MIDI keyboard! When the Audition button is pressed, the LED next to the button will illuminate and a short "Riff" (programmed as part of the preset) will play. The Riff is latched on and plays continuously until the button is pressed again. Presets can be changed while Audition is latched on.

The top line of the display changes to show the MIDI Bank Select controller values needed to select the preset being auditioned. This is an extremely handy feature when sequencing.

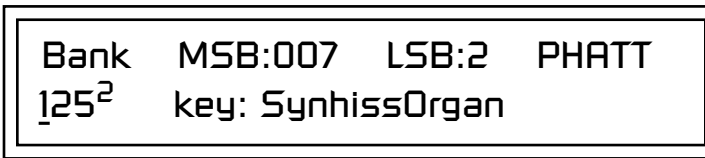

► **To Audition a Preset**

1. Select a preset by turning the data entry control while the cursor is anywhere on the lower line. The preset number field (shown above) is the normal position of the cursor and pressing the Enter button will return the cursor to this position.
2. Press the Audition button on the front panel. The Audition LED will illuminate and a short riff will play the selected preset.
3. Continue to select and audition presets.
4. Press the Audition button again to turn Audition mode off. The LED will extinguish.

Selecting and Quick Editing Presets

The first thing you'll do with the Mo'Phatt is select and play the factory provided presets. Mo'Phatt comes standard with 8 banks containing 128 presets each. See "Main Screen" on page 30.

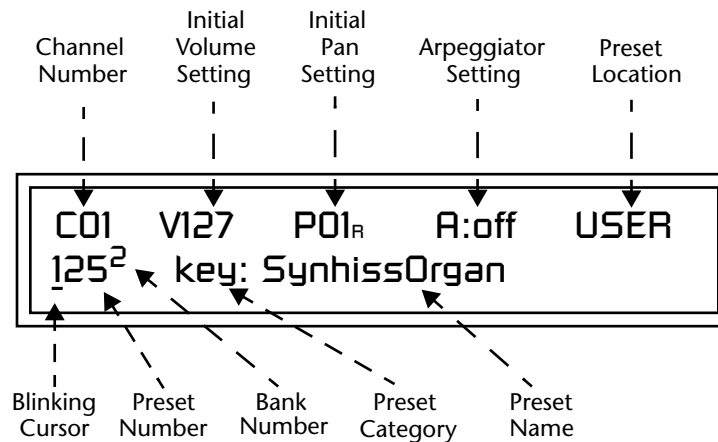

The first four banks are USER locations that can be overwritten and used to store your own presets. The presets that come stored in the USER presets are duplicated in banks 0-3 of the "Mo'Phatt" ROM bank, so feel free to overwrite them with your own presets. You won't be losing anything.

The *ROM Card* identifier is shown in the top right of the display. The preset is identified in the bottom line of the main screen (the screen that appears when you first power up the unit).

Each bank of 128 presets is identified by a superscripted *Bank Number* to the right of the preset number. The bank numbers reset to 0 at the start of each ROM card you have installed. So with the Mo'Phatt ROM installed, the USER banks will go from 0-3, then start over from 0-3 for the Mo'Phatt ROM banks.

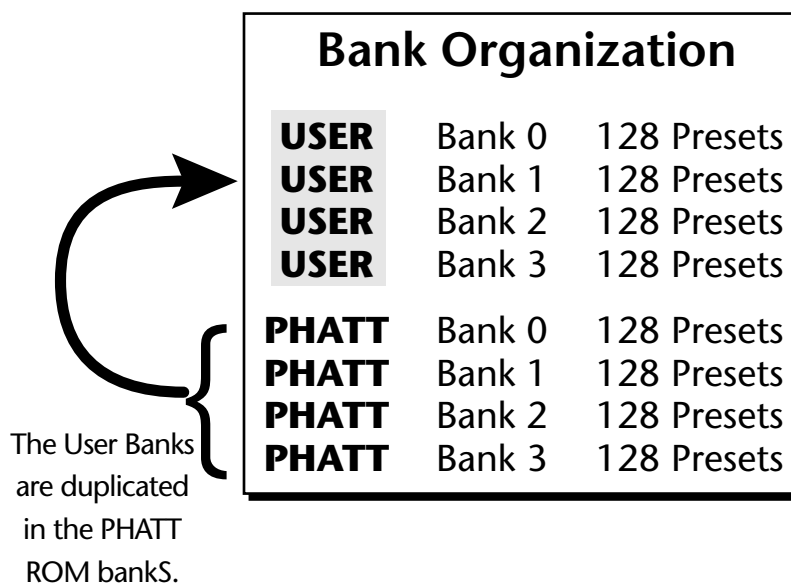

The four User Banks can hold 512 custom presets. Feel free to overwrite these since the factory user presets are duplicated in nonvolatile ROM.

To the right of the preset number and bank is the preset *Category* name followed by the *Preset Name*.

► To Change the Preset

1. Place the cursor under the first character in the Preset Number field. This is the "Home" position which is selected instantly when you press the Home/Enter button. Pressing either of the two cursor buttons repeatedly also gets you there.
2. Turn the Data Entry Control knob on the front panel to select a new preset number. If you turn the knob slowly, the presets advance one number for each "click" of the knob. If you spin the knob quickly, the numbers advance much faster (more than one number per click).
3. Play the keyboard (or press the Audition button) and listen to the sounds made by your Mo'Phatt!
4. **TURN THE FOUR KNOBS** on the front panel and note how they change the sound of each preset! Press the button to the left of the controller knobs to change the function of the knobs. Don't worry about ruining the sound, the values are automatically reset as soon as you select a new preset.

 You can select presets from the Preset Number, Bank Number, Preset Category or Preset Name fields.

Playing BEATS

This function controls the BEATS for the currently selected MIDI channel (the default channel is 1). Unlike the Arpeggiators, BEATS is only active on one MIDI channel at a time.

► To Play BEATS (Quick Start)

1. Select any preset with the **bts:** prefix.
2. Play the keyboard keys in the range shown in the default template below. Be sure to try out each key.

Default Assignment of BEATS

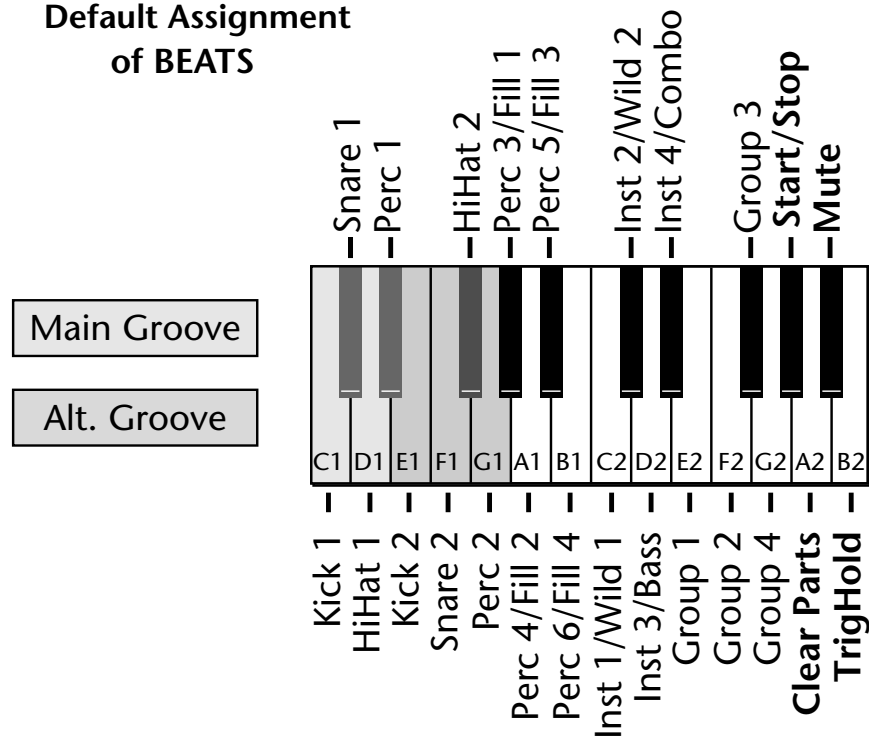

3. Now try out the “Wild 1-4” knobs and other “bts:” presets.
 - If BEATS are not playing: Go into the Arp/Beats menu, locate the screen shown below and set the parameters exactly as shown.

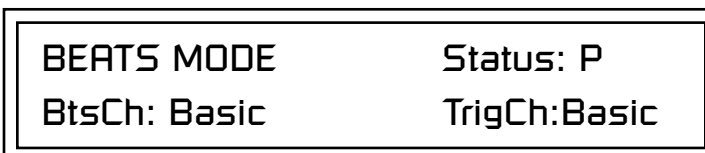

► **To Latch BEATS Triggers**

The Trigger Keys can be *Latched* so that pressing once turns a key on and pressing the key again turns it off.

1. Press the Arp/Beats button and turn the Data Entry control until the following screen appears (this is the 3rd screen from the beginning).

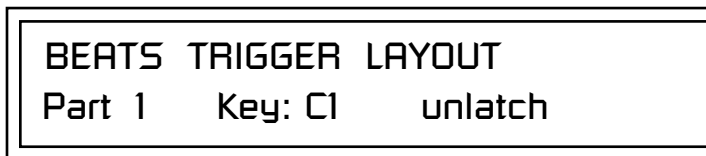

2. Press either cursor button repeatedly until it is underneath the Part field.
3. Rotate the Data Entry Control to select the desired part.
4. Press either cursor button repeatedly until it is underneath the unlatch/latch field.
5. Rotate the Data Entry Control to change the status to "Latch".
6. Repeat steps 2-5 until Parts 1-16 are latched.
7. Now play the Trigger Keys and hear the results.
8. Press the **Clear** Trigger Key to kill all latched Parts.
9. Start up a few more triggers and play with the **Mute** key.

► **To play BEATS on a different MIDI channel**

You can have your cake and eat it too.

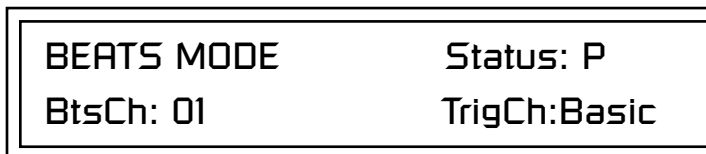

1. Press the Arp/Beats button and locate the screen shown above (the 2nd screen from the beginning).
1. Set your MIDI keyboard to transmit on channel 2.
2. Select any "bts:" preset on channel 1 (*main screen*).
3. From the main screen, change to channel 2 and select another preset.
4. The Trigger Keys now play BEATS and the other keys play the preset on channel 2

Want more?

5. On channel 2, select a preset with the **arp:** prefix.
6. Set the arpeggiator to **P** (A:P) on the main screen (channel 2).
7. Now you can play BEATS *and* arpeggiate. Yeow!

Exploring the Master Arpeggiator

Mo'Phatt's multi-channel Pattern Generator/Arpeggiator is one of the greatest features ever put in a synth. Let's explore the Master Arpeggiator.

► To Arpeggiate a Single Preset:

1. Select a preset. Note that the factory presets all have prefixes which describe the type of sound. For this investigation it might be best to choose a preset with the prefix "arp," for arpeggiator. These presets are optimized for use with the arpeggiator.
2. Set the Arp parameter in the main screen to "M" for Master Arpeggiator.

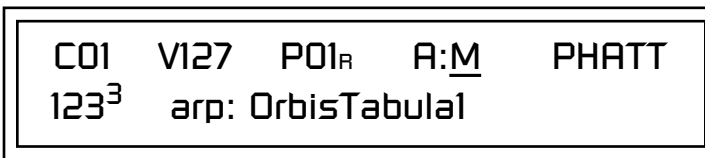

3. Press the Arp/Beats menu button on the front panel to access the master Arpeggiator menu, then use the Data Entry Control to scroll to the screen shown below.



4. Make sure the arpeggiator Status is "on." Play the keyboard to start arpeggiating.
5. Press either cursor key repeatedly to move the cursor below the Status field.
6. Turn the Data Entry Control clockwise one click. The Mode screen appears.

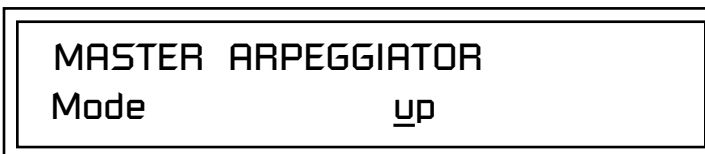

7. Use the cursor keys to move the cursor to the *Mode* field (up, down, up/down, forw asgn, backw asgn, forw/backw, random, pattern). Try out the different modes as you play the keyboard.
8. Move the cursor back to the lower left position and explore the other parameters. The *Note Value* parameter changes the rate of the arpeggios. By the way, note value is a divisor based on the Master Clock Tempo. Try changing the tempo (*page 36*), but come right back.

 Try using the control knobs to change the arpeggiator parameters.

9. Let's check out the pattern generator. Go back to the Mode screen and set the mode to "Pattern".
10. Now advance to the Pattern screen (shown below) and move the cursor to the Pattern Number field (the second field from the left).



 See the Arpeggiator Chapter for detailed information on creating Patterns.

11. Try the various patterns. There are 200 permanent factory patterns and 100 user locations to store the patterns you create. Each pattern can have up to 32 notes.

Multi-Channel Arpeggiator

Mo'Phatt can run up to 16 arpeggiators at once! Even two or three patterns at once can create a complex groove or a dynamic landscape of sound. Even if you don't think you like arpeggiators, you owe it to yourself to give these a try. They're a great source of new song ideas.

Here's one way to access this ultra-powerful feature. There is one arpeggiator for each MIDI channel. In order to arpeggiate on multiple channels, you'll need a controller that can output multiple MIDI channels at once.

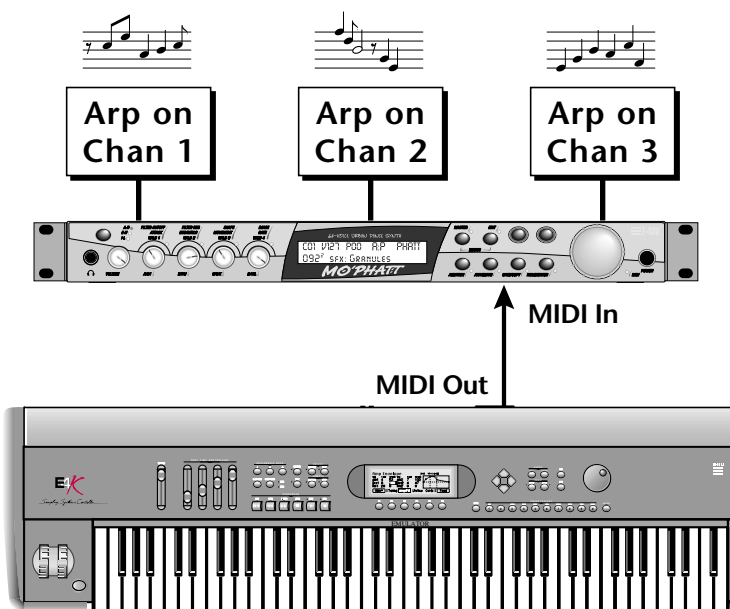

Master Keyboard transmitting on MIDI channels 1, 2, 3

Connect a multi-channel controller to Mo'Phatt to unleash its true potential!

1. Set up your MIDI keyboard so that it outputs the entire keyboard range on MIDI channels 1, 2, and 3. This procedure varies with the type of keyboard you own.
2. Put Mo'Phatt into Multi mode. This is located on the MIDI Mode page in the Master menu.
3. From the main screen, turn the arpeggiator "on" for MIDI channels 1 and 2. (We're only using two for now to keep it simple.) Select a different preset for each MIDI channel while you're at it.

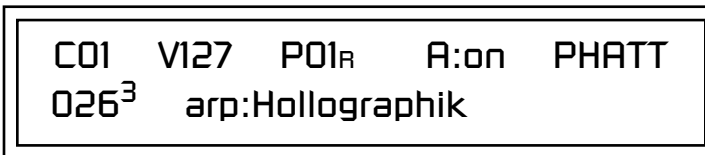

4. Start playing. You should be hearing two arpeggiators playing at once.
5. Change presets on one or both of the MIDI channels you are using (1 & 2). Since each factory preset has differently programmed arpeggiator settings, changing the preset not only changes the sound, but the arpeggiator as well.
6. Press the Control Select button on the front panel so that the "Arp/Beats" LED is illuminated. Adjust the front panel control knobs. Remember that the knobs are controlling the arpeggiator on the channel displayed in the main screen.
7. Try changing one of the channel's arpeggiator setting to "M" instead of "on." Now press the Arpeggiator menu button on the front panel and adjust the arpeggiator parameters in real-time.
8. From the Master Arpeggiator menu, set the Mode to "Pattern" then explore the different patterns. There are 200 patterns available!

 Don't forget that you can adjust the volume and pan position for each channel. Sometimes a simple volume change will bring out hidden rhythms and patterns.

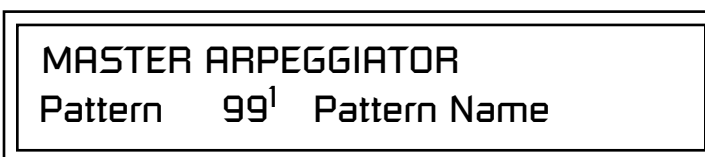

Now you're starting to get the picture of how versatile and easy to use Mo'Phatt really is.

Basic Operations

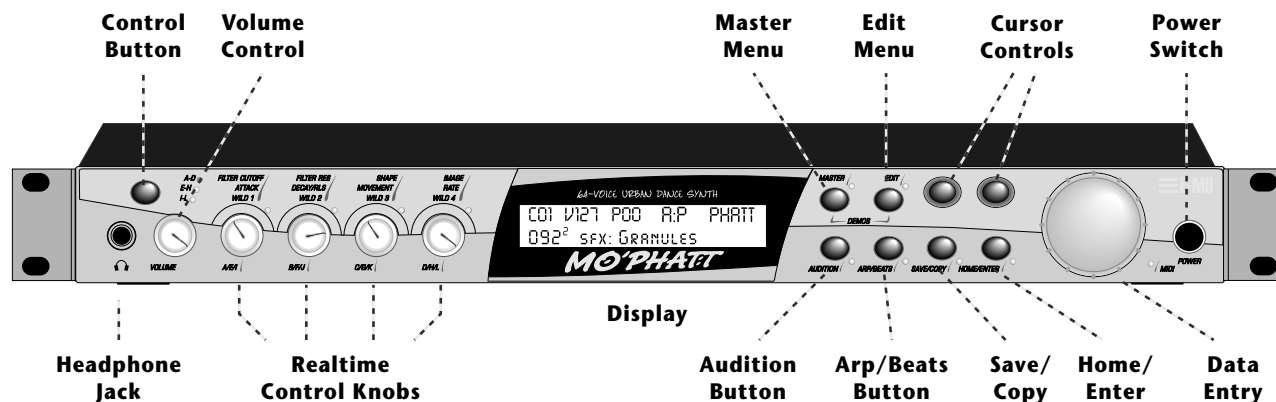

Front Panel

The Mo'Phatt front panel contains an LCD screen, nine buttons and four real-time controllers. Functions are grouped logically and the controls are arranged for ease of use. Precisely because Mo'Phatt is so simple to use, you might be tempted to skip this section. If you just can't help yourself, at least read the Real-time Controller information beginning page 27. There are several "power user" features in the interface which make programming even easier and we wouldn't want you to miss them.

Volume Control

This control is the master volume control for all audio outputs. The Volume Control does not affect any editing or user interface operations. For maximum dynamic range, turn this knob all the way up and control the volume from your mixer or amplifier.

Master Button

The Master menu contains parameters that affect the entire machine, not just certain presets. An illuminated LED to the right of the button indicates that you are in the Master menu.

Edit Button

Use the Edit menu when you want to create or modify a preset. An illuminated LED to the right of the button indicates that you are in the Edit menu.

Control Button

The Control button is used to change the function of the Controller knobs (see the next section). Each time you press the Control button, the Control Mode toggles to select only one of the three Control Rows. The currently selected Control Row is indicated by one of the three LEDs to the right of the row's label.

Audition Button



L.E.D. Beat Markers

- The Audition LED flashes off quickly on each downbeat and flashes off for a longer period on the Riff Loop.
- The Clock LED flashes to mark each quarter note.

The Audition button allows you to hear any preset without hooking up a MIDI keyboard. When the Audition button is pressed, the LED next to the button will illuminate and a short “Riff” (programmed as part of the preset) will play. The Riff is latched on and plays continuously until the button is pressed again. Presets can be changed while Audition is latched on. See “Bank Select Commands” on page 110 for more information on selecting banks via MIDI.

The top line of the display changes to show the MIDI Bank Select controller values needed to select the preset being auditioned. This handy feature lets you know the exact Bank and Preset number to enter into your sequencer.

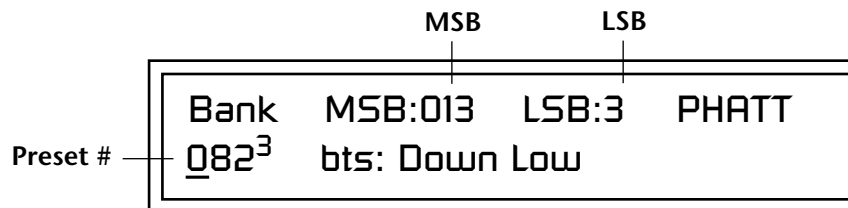

Left/Right Cursor Buttons

These buttons move the cursor to the next parameter on the display. (The cursor is a little flashing line underneath one of the parameters in the display.) Press either cursor button until the cursor is underneath the desired parameter. The cursor buttons have an auto-repeat feature which advances the cursor when the button is held continuously.

The cursor can be moved bidirectionally using the Data Entry Control while either cursor select button is held down (for example, press and hold the right cursor button and turn the Data Entry Control).

Save/Copy Button

The Save/Copy button is used to save or copy presets and to copy data. Selected groups of parameters, such as PatchCord settings, can be copied between Presets and/or between Layers using this menu.

The LED to the right of the button illuminates to indicate that you are in the Save/Copy menu. The LED also illuminates when any preset parameter has been changed in the Edit menu (or if the front panel knobs have been moved with Quick-Edit mode enabled).

Home/Enter Button

The Home/Enter button is dual purpose. In general, this button acts as the “Home” button. For example, when in an Edit menu, this button snaps the cursor to the page name field of the current screen. When viewing the Preset Select screen (we also call it the main screen), this button snaps the cursor to the preset number field. In these instances, the LED is not used.

Some screens and parameter fields use this button as the “Enter” button. In these cases, the LED blinks to indicate that the module is waiting for your response to initiate the operation.

Data Entry Control

The Data Entry Control is a stepped, variable control switch used to change parameter values. The wheel increments or decrements the current value one unit with each click. This control incorporates acceleration, which advances the value faster if the Data Entry Control is turned quickly.

Front Panel Controller Modes

The Real-time Controller Knobs serve three purposes:

1. Real-time control of synthesizer parameters
2. “Quick Editing” the initial settings of the real-time controllers
3. “Deep Editing” the parameters

This section describes each of the three uses.

Real-time Control

The Real-time controller knobs provide direct control of the Mo’Phatt’s synthesizer parameters. They are always active when on the Preset Select (main) screen. They can optionally be used to transmit MIDI controller messages to other MIDI devices.

The Control button (left of the knobs) changes the function of the real-time controller knobs. Each time the button is pressed, the Control Mode toggles to select one of the three Control Row groups. The currently selected Control Row is indicated by the illuminated LED to the right of the button. The control knob functions are determined by the selected Control Row.

The three Control Rows generate MIDI data that can control the preset on the current MIDI channel (the channel showing on the Preset and main screen. The labels (Filter Cutoff, Filter Res, Shape, Image, etc.) printed on these rows show how the factory ROM presets may be programmed to respond. *(The controls might not conform to the front panel labels depending on the preset.)* You can change the way a preset responds to MIDI A-L messages from the Edit menu (PatchCords).

There is an LED next to each of the control knobs which illuminates to indicate that the knob setting has been changed from the value programmed in the preset (when Quick Edit mode is enabled). If the knob position is returned to the original setting, the LED is extinguished.

If the “Knobs MIDI Out” parameter in the Master menu (see “Knobs/Riff MIDI Out” on page 78) is set to “transmit,” the system sends a MIDI controller message when you turn off the Control knob. The MIDI controller message is sent on the current MIDI channel (also called the basic channel) using the controller number assigned in the Master menu (see “Real-time Controller Assignment” on page 75).

The knobs only generate a message when you move a knob to a new value. The current value jumps to the new value.

Quick Edit



Quick-Edit mode must be enabled in the Master menu.

This mode uses the Controller knobs to “Quick-Edit” the currently selected preset without having to enter the Preset Edit menu. This mode is only active when on the Preset Select screen and when “Quick-Edit” is enabled in the Master menu (see “Knob Preset Quick-Edit” on page 77).

Initial controller values can be stored in every preset. When you move a knob with Quick-Edit enabled, the Initial Controller Value is updated with the knob’s new value. The knob’s LED lights indicating that the preset value has been changed. The three Control Rows’ MIDI A-L values are stored in the corresponding *Initial Controller Amount* parameter in the Edit menu (see “Initial Controller Amount” on page 152). The Save/Copy button LED illuminates to remind you that the preset has been edited. “Quick-Edits” made to a preset are lost if you select another preset before saving them.

► To Quick-Edit a Preset

1. Use the Control Knobs to change the sound of the current preset as desired.
2. Press the Save/Copy button. The display reads, “Save Preset to.”
3. Press the right cursor button to select the bottom row.
4. **Optional:** Select a new preset location if you don’t want to overwrite the current preset, or if the current preset is a ROM preset.
5. Press the Enter button to save the preset.

Deep Edit Mode

When in the Master, or Edit menus, you can use the Controller Knobs to edit parameters. Using the Controller Knobs is a faster method for entering data, but the Data Entry Control offers finer precision.

► To Enable Deep Edit Mode:

1. Press the Master button and use the Data Entry Control to advance to the “Knobs Deep Edit” screen as shown in the following illustration.



2. Press either Cursor key to move the cursor to the bottom line in the display.
3. Use the Data Entry Control to change the value to “enabled.”
4. Press the Master menu button to exit the Master menu.

When you enter any of the Edit menus:

1. The four Controller Knobs are used for editing.
2. All the Controller LEDs are off.
3. All the Control Row LEDs are off.

When you turn a knob, the field value jumps to the current knob value. You can still use the Data Entry Control for editing by moving the cursor to the desired field.

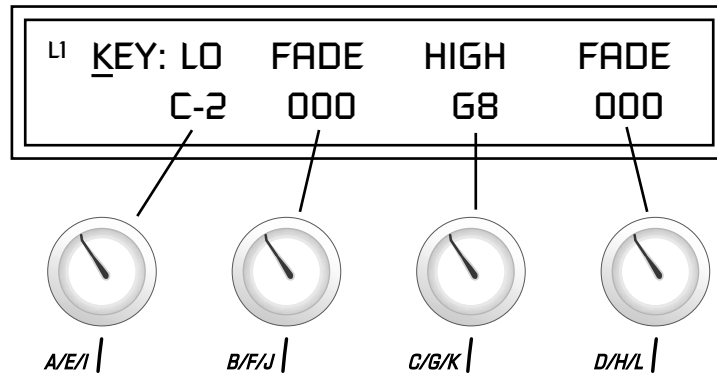

To move through menus horizontally, use the Data Entry Control (the page's title field is the default cursor position). To move through menus vertically (preset layers), press the left cursor to get to the layer field, then change layers with the Data Entry Control.

- Use the Data Entry Control to move through menus (horizontally) or layers (vertically).
- Use the Controller Knobs to change parameter values within each page.

Main Screen

The Preset Select screen is Mo'Phatt's default screen (also called the main screen) and is active when you have not selected any of the other button-activated menus. From this screen you can change or examine the Preset, Volume, Pan Position and Preset Location for each of the 16 MIDI channels.

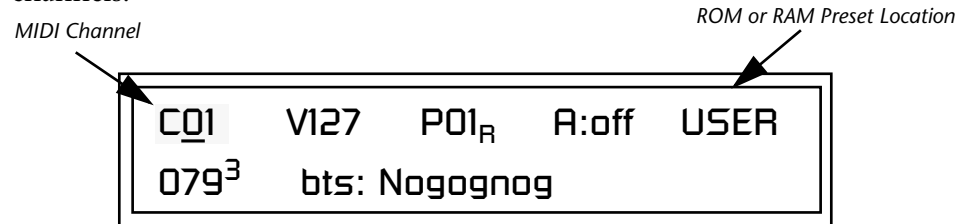

MIDI Channel Selection

 The channel number shown in the main screen is the "basic MIDI channel" when in Omni or Poly modes.

► To Change the MIDI Channel

1. Press either cursor button until the cursor is underneath the channel number. (The cursor is the little flashing line underneath one of the parameters in the display.)
2. Rotate the Data Entry Control to select a MIDI channel (01-16). As the channel number changes, the display changes to show the preset, volume, pan and preset location associated with the displayed channel.

Preset Selection

► To Change the Preset

1. Press either cursor key until the cursor is underneath the preset number. (The cursor is a little flashing line underneath one of the parameters in the display.) As you rotate the Data Entry Control, the preset number and name changes.
2. The displayed preset is assigned to the displayed MIDI channel. Presets are arranged into banks of 128, as shown in the diagram at left.

Bank	Contents
0	– 128 RAM Presets
1	– 128 RAM Presets
2	– 128 RAM Presets
3	– 128 RAM Presets
ROM 1	0 – 128 ROM Presets
	1 – 128 ROM Presets
	2 – 128 ROM Presets
	⋮
	⋮
??	Depending on ROM sets installed

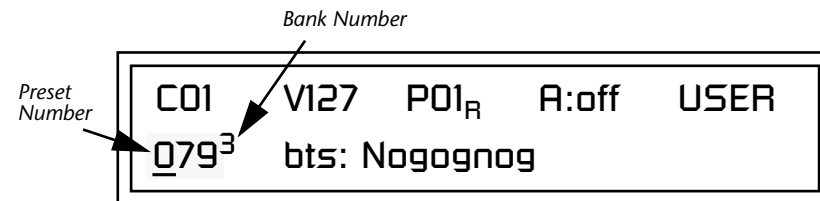

Using the screen above as an example, the superscripted number 2 in the second line of the display identifies the current bank number.

- Select banks independently of the of the preset number by locating the cursor on the Bank field and turning the Data Entry Control.

MIDI BANK SELECT			
	MSB	LSB	
	cc00	cc32	
USER	00	00	Bank 0
USER	00	01	Bank 1
USER	00	02	Bank 2
USER	00	03	Bank 3
PHATT	13	00	Bank 0
PHATT	13	01	Bank 1
PHATT	13	02	Bank 2
PHATT	13	03	Bank 3

This chart shows the MSB and LSB numbers needed to select preset banks over MIDI. Select a bank, then send the program change number. Without a bank select command, presets are selected from within the current bank.

Channel Volume

Channel Volume sets the volume of the selected MIDI channel in relation to the other channels. This is the same parameter as MIDI volume control #7, and changes made over MIDI are shown in the display.

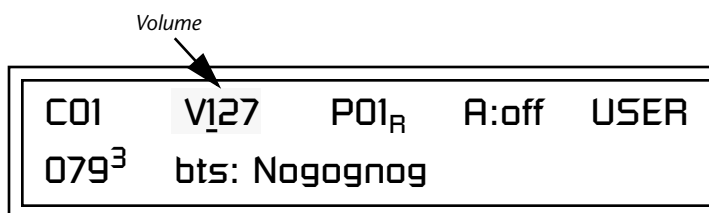

► To Change the Channel Volume

1. Press either cursor key until the cursor is underneath the volume value.
2. Rotate the Data Entry Control to select a volume level. The Channel Volume range is 000-127.

Channel Pan

Channel Pan sets the stereo position of the selected MIDI channel. This control operates like the balance control on your home stereo system. Channel Pan is the same parameter as MIDI pan controller #10, and changes made over MIDI are shown in the display.

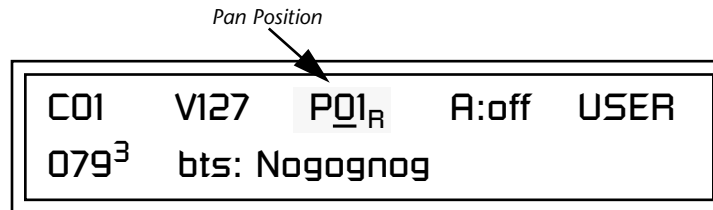

Note: Pan settings in the preset ADD algebraically with the Channel Pan setting. Therefore, if the pan setting in the preset were set to “63R,” moving the Channel Pan setting full left would return the sound to the center position.

► To Change the Channel Pan

1. Press either cursor key until the cursor is underneath the pan field.
2. Rotate the Data Entry Control to select a pan value. 64L indicates a hard left pan, 63R indicates a hard right pan. With a setting of “00,” the sound is centered in the stereo field.

Channel Arpeggiator

This function controls the arpeggiator for each MIDI channel. When the channel arpeggiator mode is set to Off, then there is no arpeggiation on that channel, regardless of what is set up in the Master Arpeggiator or preset. If the channel arpeggiator is On, the preset’s arpeggiator is used, regardless of whether or not it is turned on in the Edit menu. This lets you turn on arpeggiation from the main screen.

If the mode is set to “P” (for preset), the preset’s arpeggiator settings and on/off status is used. If the mode is set to “M” (for master), the master arpeggiator settings and on/off status (located in the Arp/Beats menu) are used. *See the “Arpeggiator/Beats Menu” on page 35 for more information.*

► To Play the Arpeggiator (Quick Start)

1. From the main screen, press either cursor key repeatedly until the cursor is underneath the arpeggiator field (A:).
2. Rotate the Data Entry Control to select “P” for preset.
3. Press either cursor key repeatedly until the cursor is underneath the Preset Category field and select “arp:” using the data entry control.
4. Press the right cursor button to move it to the Preset Name field.
5. Play notes or chords on the keyboard. Change presets as desired to audition the various patterns and presets.

Sound Navigator

Preset Category

Sound Navigator allows you to search through preset and instrument categories to find the type of sound you're looking for. Each preset and instrument has a name and a three letter preset category. You can create your own categories in order to group favorite presets. The preset category is assigned in the Edit menu (Preset Name). Instrument categories are fixed.

When you want to find presets in a particular category, you simply change the category field in the main screen, then move the cursor to the preset name field to scroll through all the presets in the selected category.

When the cursor is on the Preset Category field, turning the Data Entry Control selects different preset categories. The Name Field will change to show the first preset in each category.

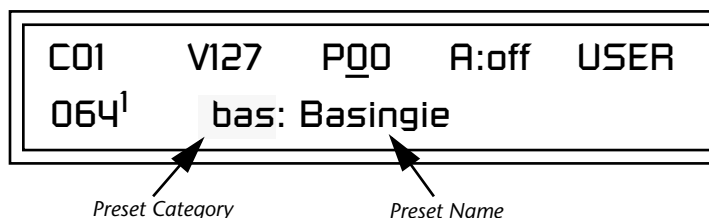

► To Change the Preset Category

1. Press either cursor key repeatedly until the cursor is underneath the preset category field.
2. Rotate the Data Entry Control to select one of the preset categories. Preset Categories are displayed in alphabetical order.

► To Select a Preset within a Category

1. After selecting a category, move the cursor to the Preset Name field.
2. Rotate the Data Entry Control to scroll through the presets in the selected category. Note that the preset numbers will no longer change sequentially.

Instrument Category

When the cursor is on the Instrument Category field (Edit menu), turning the Data Entry Control selects different instrument categories. The Name Field changes to show the first instrument in each category. Move the cursor back to the instrument name to choose other instruments in the selected category.



Multitimbral Operation

 Save the Multisetup using the instructions provided in Chapter 9: Save/Copy

Multitimbral operation means that Mo'Phatt can play more than one sound at the same time. Follow these instructions to access multiple presets on different MIDI channels simultaneously.

► To Set Up Mo'Phatt for Multitimbral Operation

1. Set the MIDI mode to "multi mode," using the MIDI mode function in the Master menu.
2. Decide which MIDI channels you want the Mo'Phatt to receive (16 channels can be used simultaneously). You can turn any unused channels OFF using the MIDI Enable function in the Master menu.
3. Select the desired preset for each of the MIDI channels you want the Mo'Phatt to receive using the Main preset selection screen. (See "Main Screen" on page 30.)
4. Mo'Phatt now responds multitimbrally on each of the MIDI channels you have specified. The volume and pan position parameters can be adjusted over MIDI (for each MIDI channel) or using the Cursor and Data Entry Control in the Preset Select screen.

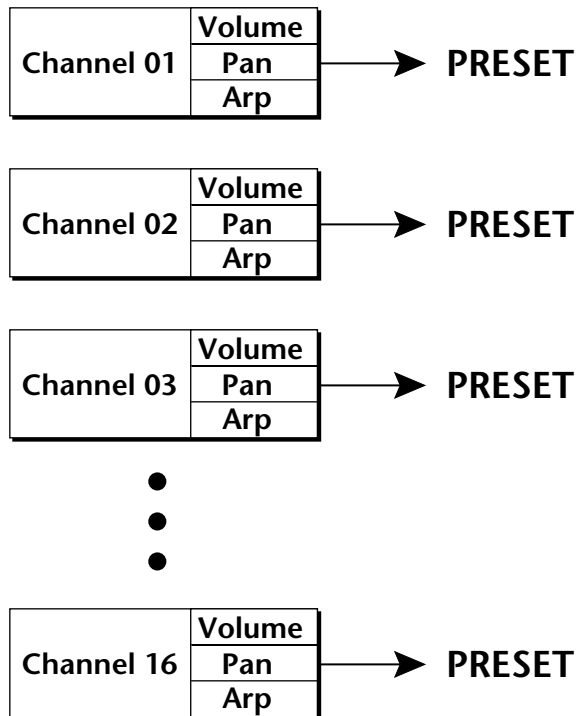

Each of the 16 MIDI channels can be assigned to play a specific Mo'Phatt preset.

Arpeggiator/Beats Menu

Mo'Phatt's SuperBEATS mode allows you to trigger, latch and unlatch synced loops and grooves from separate keys on your keyboard. Select a SuperBEATS Riff and then choose any one of Mo'Phatt's presets. Now by playing 24 assignable keyboard keys, you can bring specific *Parts* in and out. It's time to *Groove!*

Mo'Phatt can also run up to 16 simultaneously synced arpeggiators, each with a different preset sound. The arpeggiators can either play one of 7 arpeggios or can be set to play a pattern, which is a stored sequence of notes. Combined with SuperBEATS, the number of musical permutations is staggering!

► To enable the Arpeggiator/Beats menu

Press the Arp/Beats button, lighting the LED. The Arp/Beats screen displays the menu page most recently selected since powering up Mo'Phatt. The cursor appears below the first character of the screen heading on line one.

► To select a new screen

Press the Home/Enter button or press the Cursor button repeatedly until the cursor is below the screen title heading on the top line of the display. Rotate the Data Entry Control to select another screen.

► To modify a parameter

Press either Cursor button repeatedly (or hold down the right cursor button while turning the Data Entry Control) until the cursor is below the desired parameter value. Rotate the Data Entry Control to change the value.

► To access a submenu

The Beats Trigger Layout and the Master Arpeggiator screens have submenus which are accessed by pressing the cursor buttons to move the cursor to the lower left corner of the display. Select the submenu function using the Data Entry Control.

► To save Arpeggiator/BEATS parameters

Press the Save/Copy button and scroll to "Save Setup". Select a Setup number and press Enter. See "*Saving Multisetups*" on page 190.

► To return to the main screen

Press the Arp/Beats button, turning off the LED.



Arp/Beats and Master parameters are automatically saved to the current multisetup when you exit the menu, but you may wish to save to another location

Base Tempo (Master Clock)



To control Riffs using MIDI clock, be sure to set Riff Tempo (page 47) to “use current tempo”.

Mo’Phatt contains an internal Master Clock. The Master Clock controls SuperBEATS, arpeggiators, synchronizes the LFOs when in tempo-based mode, controls the times of tempo-based envelopes, and can be used as a modulation source in the PatchCords section. There are two tempo values shown in the display.

- **Base Tempo** - This is the base tempo setting before being modified by the Tempo Controller (if engaged). See “Tempo Controller” on page 77.
- **Current Tempo** - This is the actual tempo. The current tempo is equal to the base tempo modulated by the MIDI controller specified in the Tempo Controller screen. If no MIDI Tempo controller message has been received since the last Base Tempo change, the Current Tempo will be equal to the Base Tempo.

The LED to the right of the button blinks at the current tempo rate.

► To Change the Base Tempo

1. Move the cursor to the lower line of the display.
2. Adjust the Base Tempo using the Data Entry Control.

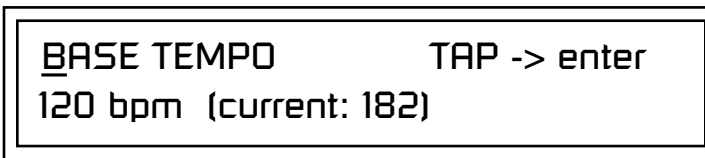

3. **To Tap Tempo** - Tap the Enter button at least three times when the cursor is on the top line of the display. Keep tapping to continuously update the tempo on each tap. The tap tempo range is 25-300 bpm.

The Base Tempo values range from 1 through 300 beats per minute (BPM) or you can select “use MIDI” to use an external MIDI clock source.

SuperBEATS

SuperBEATS is a 16-track play-only sequencer that is optimized for live performance and groove creation. Mo’Phatt contains dozens of special 16-part BEATS Riffs created by some of the best producers in the business. BEATS Riffs are normally used in conjunction with a “bts” preset containing the appropriate percussion mapping, but any preset can be selected and used.



L.E.D. Beat Markers

- The Audition LED flashes off quickly on each downbeat and flashes off for a longer period on the Riff Loop.
- The Clock LED flashes to mark each quarter note.

The BEATS channel is selected from the Beats enable screen in the Arp/Beats menu.

Here's how it works. Each of the 16 parts is assigned to a keyboard key on the selected Trigger MIDI channel. Each part is brought in or out by pressing that key. Keys can also be Latched (*press the key once to turn the part on, press it again to turn the part off*). Other control keys allow you to Mute All Parts, Clear All Parts, and Start & Stop the groove. The 16 parts are arranged in the following manner:

Main Groove	Alt. Groove	Perc / Fills	Instr/Wild
1. Kick1	5. Kick2	9. Perc3/Fill1	13. Inst1/Wild1
2. Snare1	6. Snare2	10. Perc4/Fill2	14. Inst2/Wild2
3. Hihat1	7. Hihat2	11. Perc5/Fill3	15. Inst3/Wild3
4. Bass	8. Perc2	12. Perc6/Fill4	16. Inst4/Wild4

For each BEATS Riff, you have 2 Grooves, 4 Fills which correspond to the four parts of the Main and Alternate groove, and 4 Instrument parts. By adding and removing parts, you control the complexity of the groove.

Each part can also be scaled by *Key Velocity*, allowing you to fade parts in and out (if velocity is routed to volume) as you play, or can be *Transposed* over a six octave range.

Each part can be assigned to any one of four *Groups*, which allow multiple parts to be triggered from a single key.

The chart below shows the default assignment of each Part, the 4 Groups and the Control Keys (shown in **bold**). These assignments can be modified to suit your personal preference.





BEATS (BTS) Riffs are special 16-part riffs made especially for use with BEATS mode. A Riff without the BTS prefix only has Part 1 recorded.

 Trigger layouts are saved with the Multisetup. See "Trigger Layouts" on page 216 to examine several other factory BEATS trigger layouts.

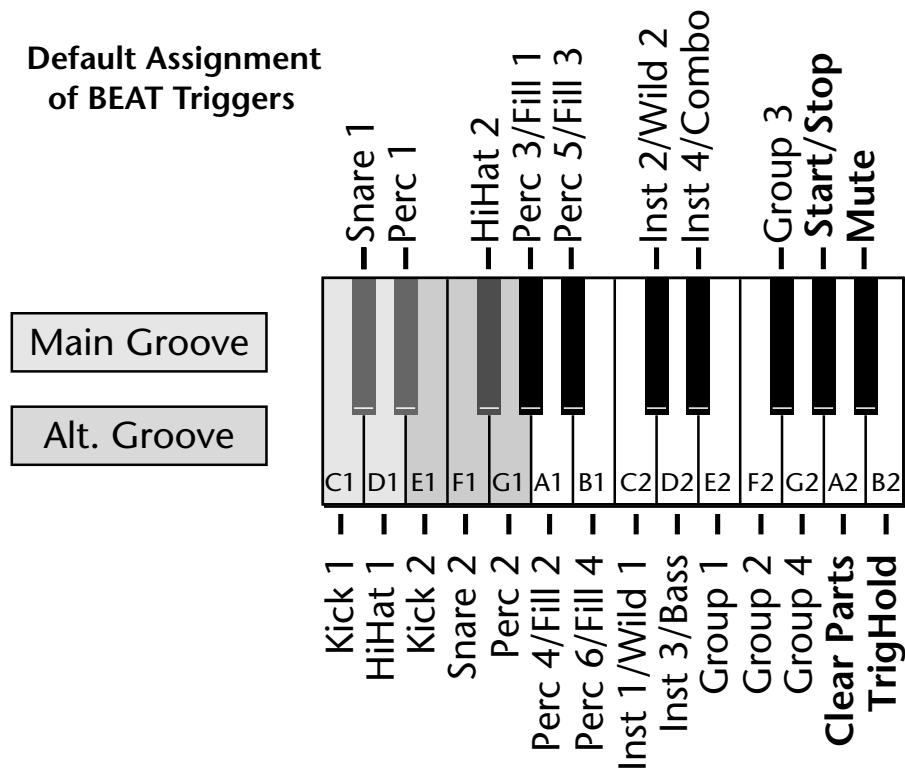
Default Assignment of BEAT Triggers



 Starting BEATS mode with the Start/Stop key allows you to start the sequencer rolling silently. Then you can bring Parts in and out using the "Busy" control.

 If Mute is set to 1-bar, the Part mutes for 1 bar then un-mutes.

 Start/Stop doesn't clear latched parts when it stops the sequencer. Any trigger played after stopping will not only start the sequencer and play that trigger's part, but also play all previously latched parts.

- Start/Stop Trigger** Starts the beat sequencer from the beginning of the sequence. When latched, pressing once starts and pressing again stops. When unlatched, the sequence runs as long as the key is held. Once the BEATS sequencer is started, it continues to run even if no triggers are active.
- Clear Parts** Clears any enabled parts. This control provides a quick and easy way to shut off all latched Parts. Latch mode has no effect on this key.
- Mute** Mutes all Parts while held, but the Beats sequencer continues running.
- Trig Hold** When this key is held, all other Trigger Keys behave as if they were in Latch mode.

The BEATS sequencer plays as long as any BEATS triggers are active. BEATS Riffs can also be **Restarted** using a MIDI Song Start command even if the BEATS channel is not currently selected. The Audition LED illuminates whenever the BEATS sequencer is running (even if no Parts are playing).

Pressing the Audition button or starting a Demo causes the Beats sequencer to stop. Pressing the Audition button plays Parts 1-4 & 16 on "bts:" presets.

All Arp/BEATS parameters are saved with the Multisetup. (See "Restoring Multisetups" on page 189 for more information.)

BEATS Mode

This screen turns BEATS mode on and has several other features which allow flexible control over BEATS mode. There are several status modes that determine when BEATS will be turned on and which Riff will be used.

BEATS and BEAT Triggers can be set to different MIDI channels. This allows you to perform on two MIDI channels at once with a keyboard that only transmits on a single MIDI channel.

BEATS MODE	Status: P
BtsCh: Basic	TrigCh:Basic



The Basic Channel is the MIDI channel currently displayed in the Main Screen.

Status

- **Off** BEATS mode off.
- **On**. BEATS mode on. The Riff assigned in the preset is used.
- **P** BEATS mode is turned on *ONLY* if the Riff assigned in the preset is a "BTS" riff. The Riff assigned in the preset is used. (*Default setting*)
- **M** BEATS mode on. The Master Riff is used (Arp/Beats menu).

BEATS MODE	Status: P
BtsCh: Basic	TrigCh:Basic

Beats Channel (BtsCh)

- **01-16** Selects the MIDI channel on which BEATS play.
- **Basic** BEATS play on the MIDI channel displayed in the Main Screen.

Trigger Channel (TrigCh)

- **01-16** Selects the MIDI channel on which Trigger Keys will be active.
- **Basic** Sets the Trigger Keys to the MIDI channel displayed on the Main Screen.

► **To Play BEATS (Quick Start)**

1. Select any preset with the **bts:** prefix.
 2. Play the keyboard keys from C1 to B2.
 3. Refer to the “Default Assignment” diagram on page 37 and try out each of the keys.
 4. Try out the Wild 1-4 knobs and other “bts:” presets. *Now check out the other cool BEATS controls explained in this chapter!*
- **If BEATS are not playing:** Locate the screen at the top of this page in the Arp/Beats menu and set the parameters exactly as shown.

► **To Play BEATS on a different MIDI channel**

This is just an example of how you might use this feature.

1. Set your MIDI keyboard to transmit on channel 2.
2. Set the Status to **P**.
3. Set the Beats Channel to **01**.
4. Set the Trigger Channel to **Basic**.
5. Select any “bts:” preset on channel 1 (*main screen*).
6. From the main screen, change to channel 2 and select another preset.
7. The Trigger Keys now play BEATS and the other keys play the preset on channel 2.

BEATS Controllers

BEATS can be controlled using the front panel real-time controllers or external MIDI continuous controllers. **Controllers are patched to BEATS via the Preset PatchCords located in the Edit menu.** The following Preset PatchCord destinations control BEATS.

Beat Velocity Group 1-4 (BtsVelG1 -> BtsVelG4)

Parts assigned to one of the four BEATS groups can have their velocity scaled by the controller input. Since most “bts” presets have velocity controlling volume, this control can be used to mix the relative levels of the Groups.

Beats velocity works as a percent *addition*. An input value of 0 (or no Cord) means change the velocity by 0%. A full scale modulation setting of 100% in the PatchCord adds 100% to the velocity value $100\% + 100\% = 200\%$. A PatchCord setting of -100% *subtracts* 100% from the velocity (making it 0). Beat velocity scalings are reset with a preset change.

Beat Xpose Group 1-4 (BtsXpsG1 -> BtsXpsG4)

Parts assigned to one of the four BEATS groups are transposed by the controller input. Transpose works by shifting the keyboard position and not by changing the tuning of individual notes. Therefore, on a BEATS presets (bts), where different instruments are assigned to each key, Transpose has the effect of changing the instrument used by a particular part. This control ADDS to the Part Transpose set in the Beats Transpose screen (page 45). Beat transpose offsets are reset with a preset change.

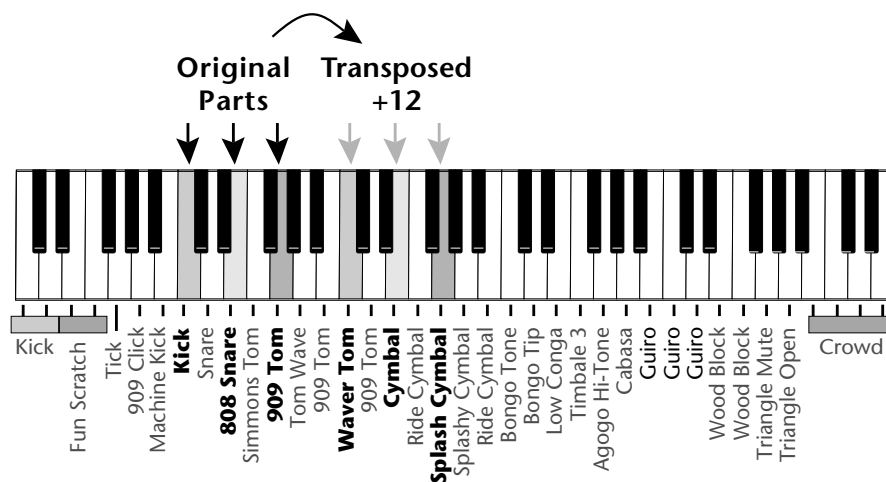

Beat Busy (BtsBusy)

This destination determines which parts are enabled. Beat Busy will accept either positive or negative values.

- **Positive values** *Add* parts to whatever parts are triggered
- **Negative values** *Remove* parts that are triggered.

 A PatchCord amount of 50% is enough to drive Beat Busy to the maximum setting.

Bidirectional Mod Wheel:
Set Mod Wheel to BtsBusy with a Cord amount of +100, then add a DC bias to BtsBusy with a Cord amount of -50. Wheel now adds or subtracts "Busyness".

 **Cool Tip!** Connecting Key Pressure to Beat Busy at 50% increases BEAT complexity the harder you press.

Suppose the pitch wheel (which can output both positive and negative values) were connected to Beat Busy and four Key Triggers are down. As the pitch wheel is moved from center to fully up, the remaining parts will be enabled until the pitch wheel is fully up and all parts are playing. Moving the pitch wheel from center to fully down, the four triggered parts are sequentially removed until at the most negative position of the wheel, no parts are playing.

The Busy control acts on the BEATS condition whenever the control is changed. Playing more triggers without changing the Busy control simply adds them until the Busy control is changed again, at which point it will possibly add or subtract parts as needed.

The interaction between the Busy control, Triggers, Part Velocity and Group Velocity can get complicated, but works according to this rule:

WHICHEVER CONTROL WAS LAST CHANGED TAKES OVER

When interacting with the Group Velocity scale control, the Busy control ignores group velocity even when it is set to zero, enabling and disabling parts as necessary. If the Group Velocity is changed *after* the Busy control, it takes control, scaling parts as it deems necessary.

The Busy control *does* take the Part velocity into account when adding and subtracting parts. If a part has a velocity of 0%, it is removed from the list of parts that the Busy control adds or subtracts. Therefore, you can use the Part Velocity control to remove parts you don't want to hear.

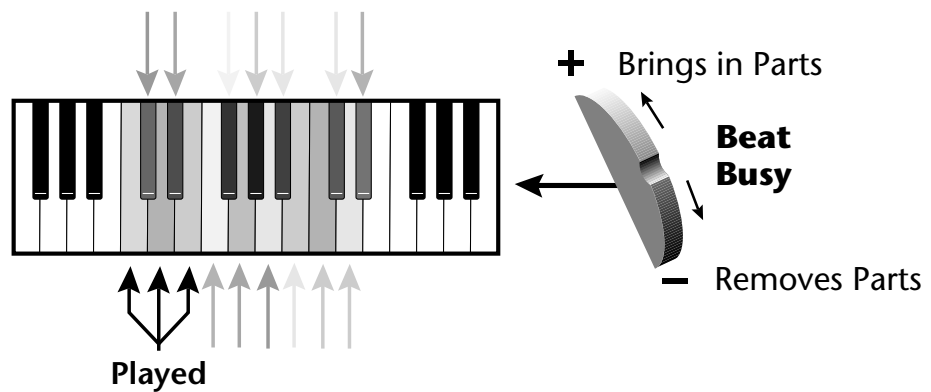

Positive controller values bring in new Parts and negative controller values remove Parts that are latched or held. In this example, the Pitch Wheel is connected to Beat Busy since it outputs negative as well as positive values.

Beat Variation (BtsVari)

Beat Variation varies which Parts are brought in and out using the Beat Busy control. Increasing this control mixes up the order in which Parts are brought in and out, thus providing even more permutations to the BEAT.

Beats Trigger Layout



Save your Beats Trigger Layouts and all other Arp/BEATS parameters using the "Save Setup" function located in the Save/Copy menu.

This screen assigns the BEATS triggers to keyboard notes on the BEATS channel. For each Part, Group and Control Key you can select the following options:

- **Key** Selects which keyboard key triggers the Part
- **Latch** The first key press turns the Part on, the next turns it off.
- **Unlatch** The Part plays only while the key is held.
- **1-bar** The Part plays for one bar then stops.

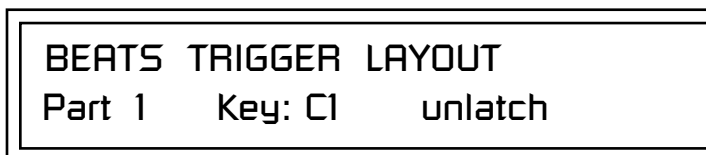

1-Bar Trigger Option

The 1-bar option requires a bit of explanation. When a trigger key is pressed before the last beat of the measure, the part will continue playing until the end of the measure. If the Trigger Key is pressed after the last beat of the measure, the part waits until the next measure before playing. Then it plays for the entire measure and stops. The time signature and the measure bounds are determined by the particular BEATS Riff you are playing.

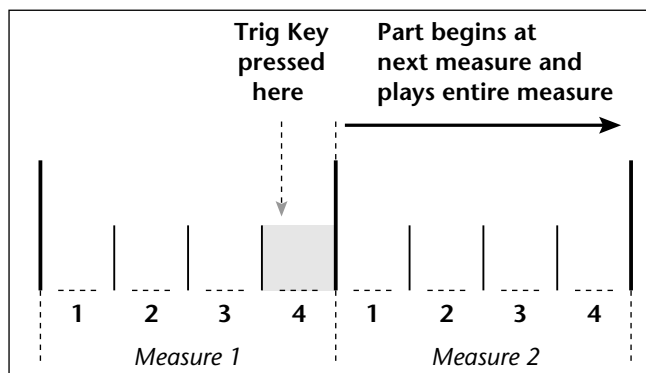
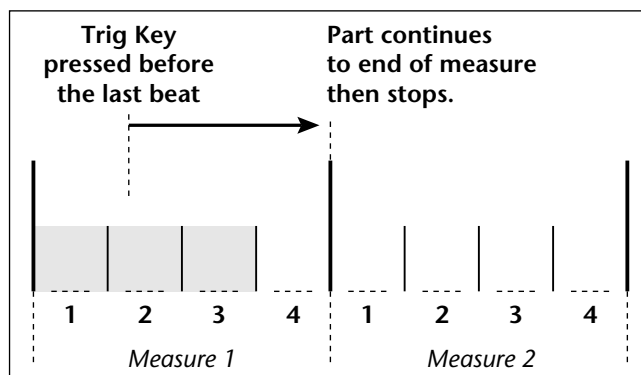

Beats Trigger Offset

This function slides the Beats Trigger keys (*assigned in the previous screen*) up and down the keyboard. This makes it easy to change the keyboard location of the trigger keys without having to re-assign each key. A positive offset moves the group of triggers up the keyboard by the designated number of keys. Negative offsets move the trigger group lower on the keyboard.

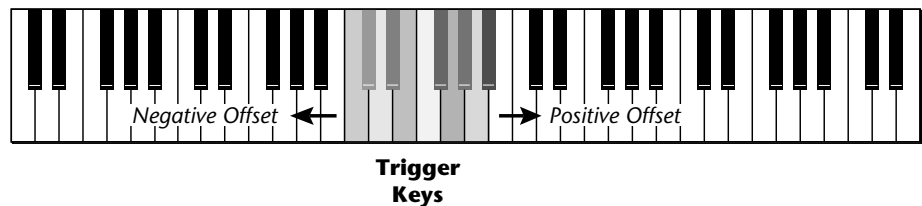
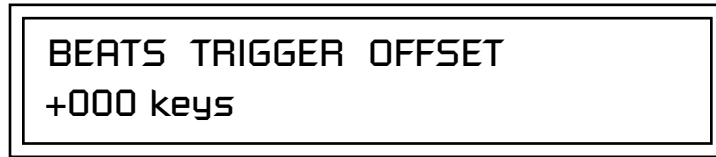

Beats Trigger Offset slides the entire group of beats triggers up or down the keyboard.

Beats Part Velocity

Each note of a BEATS Riff can have its recorded velocity scaled by a value (from 0 to 120%) of the recorded velocity or the actual played velocity of the trigger key can be used (trigger vel). For example, if a note's velocity is 80, scaling by 110% will increase the note's velocity to 88. This feature allows you to control the mix of the different parts in advance or "on-the-fly" as you play. If a part's velocity is set to 0%, that part will be removed from the mix.

Select Part

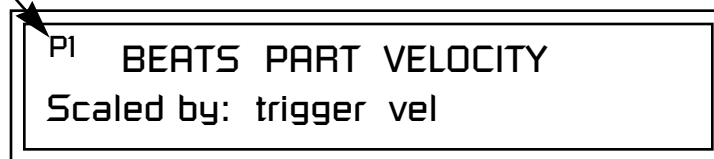

► To Set the Velocity for each Part

1. Press the left cursor button to move the cursor under the Part field.
2. Select the Part number using the Data Entry Control. Parts 1-16 can be selected. (*All parts, shown as an "A", can be edited at once if "Edit All Layers" is enabled in the Master menu.*)
3. Move the cursor to the bottom line using the cursor keys and adjust the Velocity Scaling percentage using the Data Entry Control.
4. Repeat steps 1 through 3 for all the Parts you wish to adjust.
5. Press the Enter/Home button or use the cursor keys to move the cursor back to the screen heading.

Beats Part Transpose

Each Part of a BEAT Riff can be transposed up to 36 semitones up or down. Transpose works by shifting the keyboard position and not by changing the tuning of individual notes. Therefore, on a BEATS preset (bts:), where different instruments are assigned to each key, **Transpose has the effect of changing the instrument used by a particular part.** On a preset where a single sound covers the entire keyboard, Transpose will actually transpose the sound.

Select Part



► To set the Transposition for each Part

1. Press the left cursor button to move the cursor under the Part field.
2. Select the Part number using the Data Entry Control. Parts 1-16 can be selected. (All parts, shown as an "A", can be edited at once if "Edit All Layers" is enabled in the Master menu.)
3. Move the cursor to the bottom line using the cursor keys and adjust the Transposition in semitones using the Data Entry Control.
4. Repeat steps 1 through 3 for all the Parts you wish to adjust.
5. Press the Enter/Home button or use the cursor keys to move the cursor back to the screen heading.

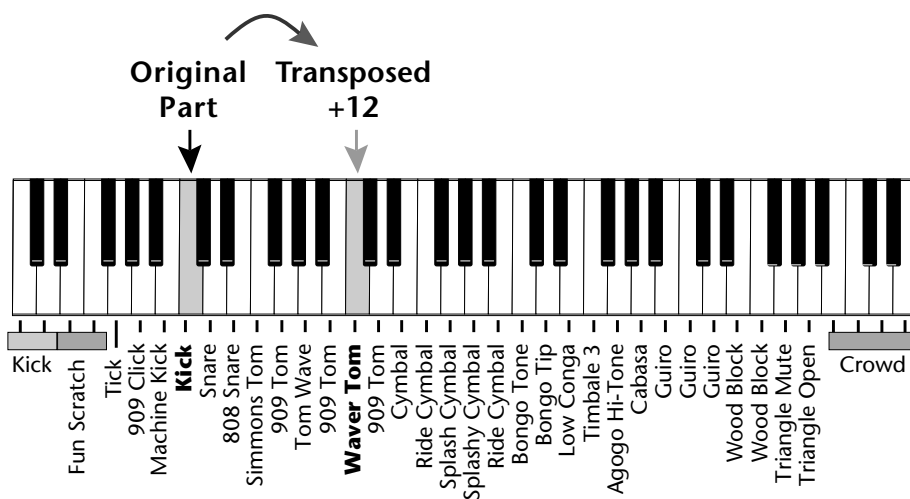

Beats Part Group

This screen is where you assign Parts to one of the four Groups. By grouping, you can play multiple parts with a single key. A part can be in one and only one group, or in no groups.

Select Part

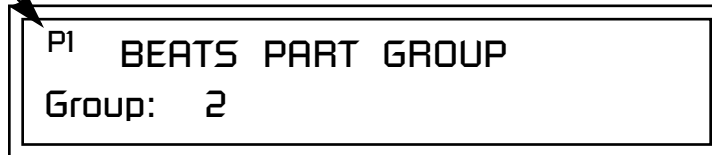

All Parts assigned to a Group will stop playing when the Group key is triggered, then untriggered even if the individual Parts in the Group are latched.

► To Assign a Part to a Group

1. Press the left cursor button to move the cursor under the Part field.
2. Select the Part number using the Data Entry Control. Parts 1-16 can be selected. (All parts, shown as an "A", can be edited at once if "Edit All Layers" is enabled in the Master menu.)
3. Move the cursor to the bottom line using the cursor keys and select the Group (1-4 or none) using the Data Entry Control.
4. Repeat steps 1 through 3 for all the Parts you wish to assign.
5. Press the Enter/Home button or use the cursor keys to move the cursor back to the screen heading.

Master Riff

The Master Riff is selected from this screen. The Master Riff is used when Master (M) is selected for BEATS in Beats mode enable screen.



► To Assign the Master Riff

1. Use the cursor buttons to move the cursor to the lower line of the display.
2. Select the desired Riff using the Data Entry Control. (BEATS Riffs are identified by the **BTS** prefix.)
3. If there is more than one ROM in Mo'Phatt you can select Riffs from either ROM set. Move the cursor under the ROM ID and select using the Data Entry Control.
4. Press the Enter/Home button or use the cursor keys to move the cursor back to the screen heading.

Riff Tempo

This setting determines whether **Riff Tempo** (the tempo stored with each Riff) or the **Current Tempo** (the Base Tempo from the Master Clock) will be used for BEATS.

To control the Riff Tempo from MIDI clock, set Riff Tempo to “use current tempo” and Base Tempo to “use MIDI”.

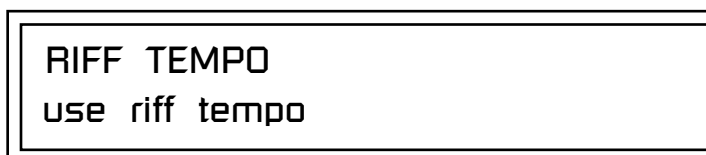

► To Set the Riff Tempo Mode

1. Use the cursor buttons to move the cursor to the lower line of the display.
2. Select “use riff tempo” or “use current tempo” using the Data Entry Control.
3. Press the Enter/Home button or use the cursor keys to move the cursor back to the screen heading.

Riff Controllers

Riffs contain real-time control information. This function allows you to turn these controllers On or Off for the Riffs. This control affects Audition Riffs as well as BEATS Riffs.



► To Turn Riff Controllers On or Off

1. Use the cursor buttons to move the cursor to the lower line of the display.
2. Select “use riff controllers” or “ignore riff controllers” using the Data Entry Control.
3. Press the Enter/Home button or use the cursor keys to move the cursor back to the screen heading.

MIDI Song Start

This function enables or disables MIDI Song Start for the Arpeggiator and Riffs. The MIDI Song Start option restarts the arpeggiator and/or Riff (BEAT) to the beginning when a MIDI Song Start command is received. This is useful for synchronizing arpeggios and BEATS when recording into, or playing along with a sequencer. You can choose to resync: Arp, Riff, both Arp and Riff, or disable MIDI Song Start.

MIDI SONG START
resyncs arps & riffs

Arp/Riff MIDI Out

This parameter selects whether or not the Arpeggiator and/or Riff (BEATS) note data is sent to the MIDI out port. This feature lets you use Mo'Phatt as an arpeggiator or sequencer for your other MIDI instruments. It also lets you record the arpeggios and Riffs into a MIDI sequencer. You can choose to transmit: Arpeggiator data, Riff data, both Arp and Riff data, or nothing.

ARP/RIFF MIDI OUT
don't transmit

Arpeggiators

An arpeggiator moves a pattern of notes sequentially over a range of the keyboard. Mo'Phatt has the unique ability to play a different arpeggiator on each MIDI channel!

Arpeggiator settings can be defined as part of the preset (using the Arp parameters in the Edit menu), or globally in the Arpeggiator menu. The preset and master arpeggiators have the same parameters which we define in this chapter.

The Arp field in the main screen defines which arpeggiator settings will be used. "M" uses the master Arpeggiator settings and on/off status (as defined in the Arpeggiator menu). "P" uses the preset's arpeggiator settings and on/off status (as defined in the Edit menu). Choosing "On" uses the preset's arpeggiator settings regardless of whether or not it is turned on in the Edit menu and Off turns off the arpeggiator regardless of the settings and status specified in either menu.



SAVE your Arp setups
and name them using the "Save Setup" function located in the Save/Copy menu. See "Saving Multisetups" on page 190.

Arp Settings in the
Preset are Used

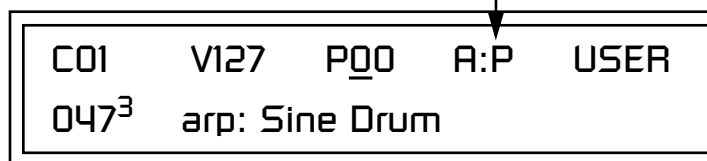

All arpeggiators share Mo'Phatt's master clock and its current setting. The master clock can be Mo'Phatt's internal clock or an external MIDI clock. Although the arpeggiators use the master clock setting, the tempo divisor can be unique for each arpeggiator setup.

Arpeggiator modes include up, up/down, forward assign, backward assign, forward/backward assign and random as well as play *Patterns*. Patterns are pre-recorded sequences of notes and rests. All key-on notes play the pattern. For example, if you play a chord, all the notes in the chord play the pattern in harmony. Mo'Phatt contains 200 factory patterns and 100 user definable patterns.

Arp Controllers

The Arpeggiators can be controlled using the front panel real-time controllers or external MIDI continuous controllers. Controllers are patched to Arps via the Preset PatchCords located in the Edit menu. See *“Preset Patchcords” on page 151*. The following Preset PatchCord destinations control the Arpeggiators.

Arpeggiator Resolution (ArpRes)

This control changes the Arpeggiator Note Value, which defines the length of the notes when playing arpeggiated chords. It *adds* to the note value set in the Arpeggiator Note Value screen. See *“Note Value” on page 52*.

Arpeggiator Extension (ArpExt)

This control changes the Arpeggiator Extension Count. It *adds* to the extension count programmed in the Arpeggiator Note Value screen. See *“Extension Count” on page 54*.

Arpeggiator Velocity (ArpVel)

This control changes the Arpeggiator Velocity Value. It *scales* the velocity value set in the Arpeggiator Note Value screen. See *“Velocity” on page 53*.

Arpeggiator Gate (ArpGate)

This control changes the Arpeggiator Gate Time. It *adds* to the gate time set in the Arpeggiator Gate Time screen. See *“Gate Time” on page 53*.

Arpeggiator Interval (ArpIntvl)

This control modulates the Arpeggiator Extension Interval. It *adds* to the extension programmed in the Arpeggiator Extension Interval screen. See *“Extension Interval” on page 54*.

Master Arpeggiator Parameters

The Master Arpeggiator is defined in the Arp/Beats menu. The Arpeggiator mode selected on the Main Screen determines whether the Master arpeggiator or the Preset menu arpeggiator settings are used.

► To Access the Master Arpeggiator Parameters

1. Press the Arpeggiator menu button lighting the LED. The Arpeggiator menu screen displays the menu page most recently selected since powering up Mo’Phatt. The cursor appears below the first character of the screen heading on line one.
2. Use the right cursor button to advance the cursor to the first field in the bottom line of the screen.
3. Now, use the Data Entry Control to access the various Master Arpeggiator parameters.
4. Save your Arpeggiator settings using the “Save Setup” function on the Save/Copy menu.

Status

The Status parameter turns the Master Arpeggiator on and off. The Channel Arpeggiator setting in the main screen overrides this setting. For example, if you set the Arpeggiator in the main screen to “off,” and turn it “on” here, it still will not play.

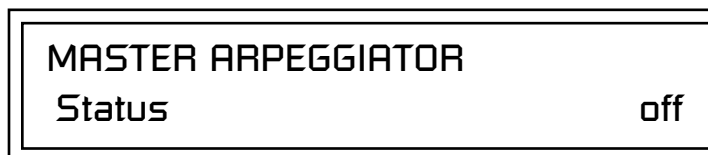

Mode

The Mode parameter determines the direction or pattern mode of the arpeggiated notes.

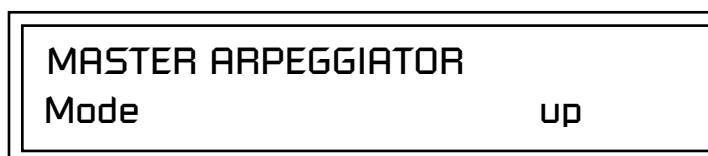

The eight arpeggiator modes are:

- **Up** Held notes arpeggiate continuously from lowest to highest pitch.
- **Down** Held notes arpeggiate continuously from highest to lowest pitch.
- **Up/Down** Held notes arpeggiate continuously from lowest to highest pitch, then from highest to lowest, then repeat this cycle.
- **Fwd Assign** Held notes arpeggiate continuously in the order in which the keys were pressed.
- **Bkwd Assign** Held notes arpeggiate continuously in the reverse order in which the keys were pressed.
- **Fwd/Bkwd** Held notes arpeggiate continuously in the order in which the keys were pressed, then arpeggiate in the reverse order that they were pressed. The cycle is then repeated.
- **Random** Held notes arpeggiate continuously in a random fashion.
- **Pattern** Held notes play the selected pattern (see “Pattern” on page 52 for details).

Note Value

The Note Value determines the duration of each note played. This parameter is used in non-pattern mode only.



 Note value has no effect when the mode is set to "pattern."

Following is a list of possible Note Values and the relative number of clocks used for each.

Note Value	MIDI Clock
Double Whole Note	192
Dotted Whole Note	144
Double Note Triplet.....	128
Whole Note	96
Dotted Half Note	72
Whole Note Triplet.....	64
Half Note	48
Dotted Quarter Note	36
Half Note Triplet.....	32
Quarter Note	24
Dotted Eighth Note	18
Quarter Note Triplet	16
8th Note	12
Dotted 16th Note	9
8th Note Triplet.....	8
16th Note	6
Dotted 32nd Note	4.5
16th Note Triplet.....	4
32nd Note	3

Arpeggiator Pattern Speed

The Arpeggiator Pattern Speed parameter lets you change the playback rate of Patterns by 1/4x, 1/2x, 1x (normal), 2x or 4x normal speed.

Pattern

This field lets you choose the pattern used when the arpeggiator Mode is set to "Pattern." There are 200 factory programmed patterns and you can create an additional 100 user definable patterns (see "Editing a User Arpeggiator Pattern" on page 59).

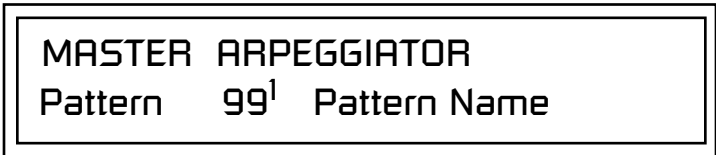

Velocity

The Velocity parameter determines the velocity at which each note arpeggiates. Velocity can be defined by the velocity value specified (from 1 through 127), or by the actual velocity of the played note (played). Bear in mind that velocity values do not have an effect on the sound unless the preset is programmed to respond to velocity.

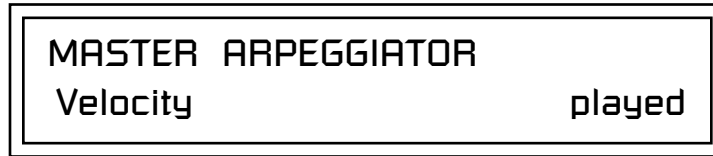

Gate Time

The Gate Time parameter works together with the Note Value parameter. Just as Note Value defines the length of a note, the Gate Time sets the percentage of the Note Value time played. This can have a dramatic effect on the sound depending on how the envelope generators are programmed.

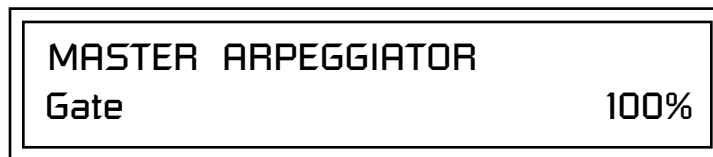

 The *note-on* time is used for the start-of-time when calculating note durations. See "Duration" on page 56.

With a Gate Time setting of 100% the note is held on until the next note starts. The envelope generators never advance to the Release stages. With a Gate Time setting of 50%, the note is released halfway through the note cycle and the envelope generators proceed to their release stages until the next note occurs. Refer to the following illustration.

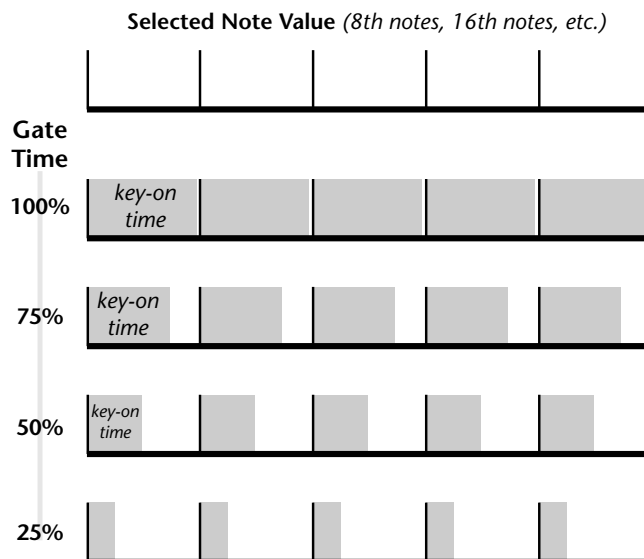

Extension Count

The Extension Count parameter specifies how many times the Extension Interval is carried out. With an Extension Count of 0, the arpeggio plays only the notes pressed. With an Extension Count of 1, the arpeggio plays the notes pressed, then plays the same notes (in the same order), transposed by the Extension Interval amount. The cycle is then repeated.



For example, with the Extension Interval set to 12 (an octave) and an Extension Count of 2, and with the Arpeggiator Mode set to Fwd Assign, if you played E2, then C2, then G2, the arpeggiated sequence would consist of: E2, C2, G2, then E3, C3, G3, and then E4, C4, G4. The Extension Count values range from 0 through 15. Refer to the following illustration.

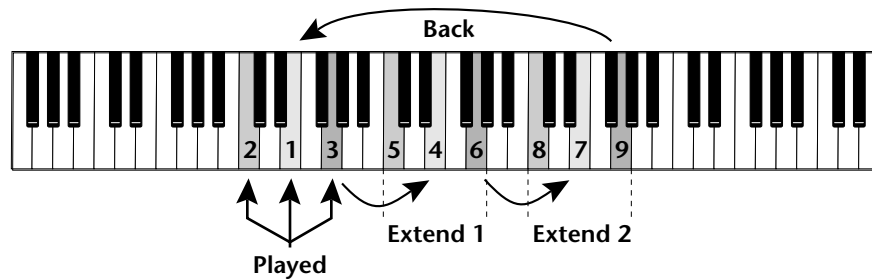

Extension Interval

The Extension Interval specifies the additional intervals played when you press a key. For example, suppose you played C2 with an Interval of 7 (a Major 5th), Up mode, and an Extension Count of 2. The arpeggio alternates between C2 and G2.

The Extension Interval values range from 1 through 16.



Sync

The Sync parameter defines when a note is played in relation to when the key is pressed. When set to “Key Sync”, the note sounds the instant a key is pressed. When set to “Quantized”, the note does not sound until the next occurrence of the selected note value.

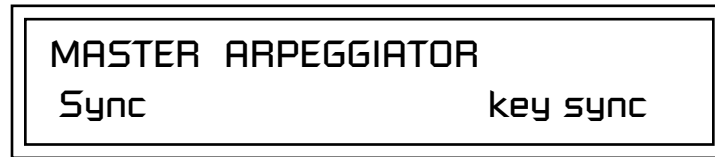

The following diagram illustrates how Key Sync and Quantize work.

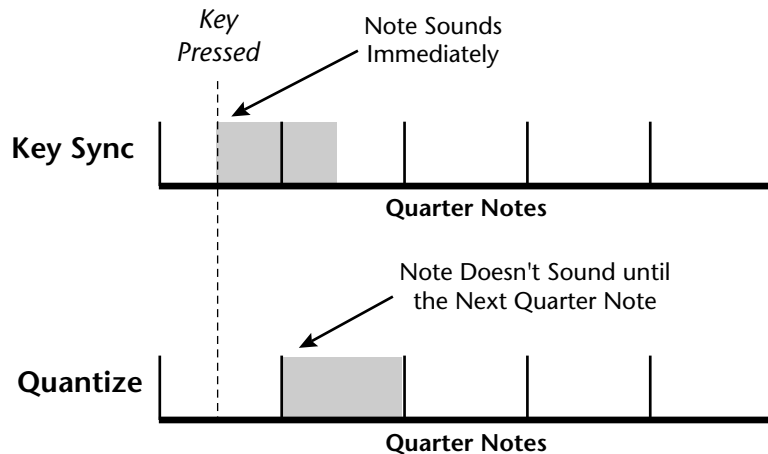

Pre-Delay

The Pre-Delay value determines how long the arpeggiator is delayed before becoming active after the first “note-on.” During the pre-delay period, notes are played normally (as if the arpeggiator was off). After the pre-delay period has elapsed, the arpeggiator kicks in. Once you release all the keys on the controller, the pre-delay starts over with the next note-on. In combination with the Duration parameter, Pre-Delay lets you create many more variations in the arpeggio patterns. *Please refer to the diagram on page 57.*

You can play the preset normally as long as you don't hold the notes longer than the Pre-Delay. If you do, the arpeggiator starts in. When used in conjunction with multiple arpeggiators or BEATS mode, Pre-Delay allows you to offset the time between the different patterns.

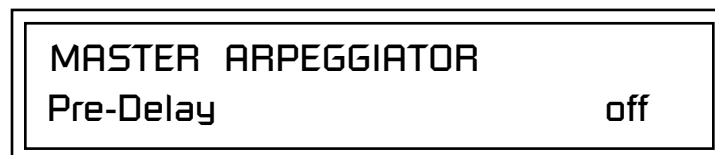

Duration

This parameter defines how long the arpeggiator plays before stopping. The Duration is specified in note values. Therefore if an arpeggio were running at a 16th *Note Value* and the Duration were set to a whole note, the arpeggiator would play 16 steps before stopping. After the duration has elapsed, the arpeggiator remains inactive until the key is released. If Duration is set to Off, the arpeggio repeats as long as the notes are held (Infinite Duration).

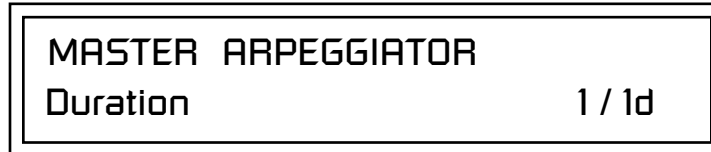

Duration can be used to modify the patterns and increase the possible pattern combinations and variations. Because this parameter limits the length of arpeggiator play time, it can change the arpeggio pattern when the Duration is less than the length of the arpeggio. You can set the arpeggio to repeat continuously using the *Recycle* function described below.

Post-Delay

This parameter is only relevant when both the "Duration" and "Recycle" parameters are not in the "Off" state. The Post-Delay value determines how long the arpeggiator is delayed after the Duration period. *Please refer to the diagram on page 57.* During the post-delay period, notes are played normally (as if the arpeggiator was off). After the post-delay period has elapsed, the arpeggiator either jumps to the beginning of the Pre-Delay period or to the beginning of the Duration period depending on the Recycle setting.

If the arpeggiator is playing an extension when the Duration expires, the notes in the extension will continue to sound during the Post-Delay (*and Pre-Delay if on*). On the next pass through the Duration period, the extension continues where it left off.

Post-Delay increases the number of possible variations in the beat and allows the recycle loop to be set to an exact measure of time.

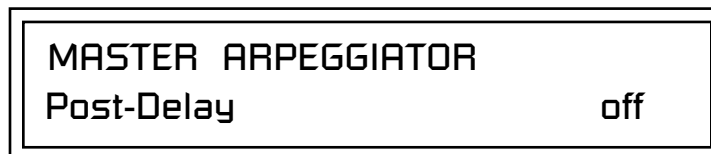

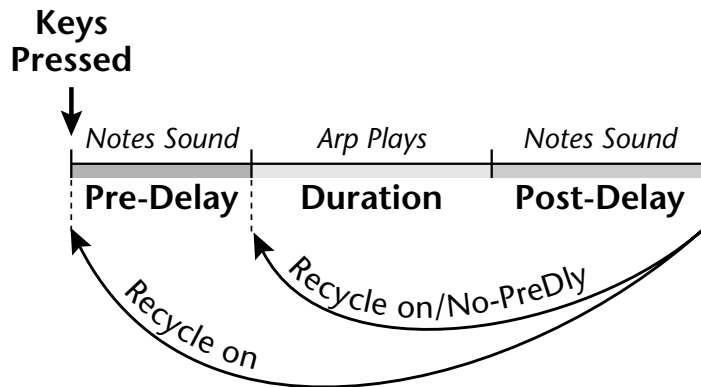

Recycle

Recycle enables the pattern or arpeggio to repeat. This parameter works together with the *Duration* and *Pre/Post Delay* parameters to allow the loop to be set to an exact measure of time. The “on/No-PreDelay” option bypasses the predelay period. With Recycle turned Off, the pattern or arpeggio stops at the end of the Post-Delay period.

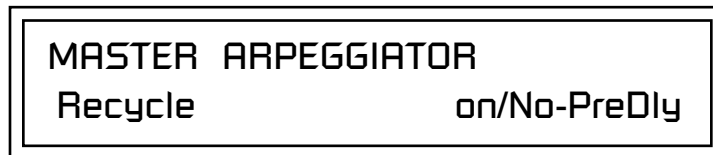

Keyboard Thru

When enabled, Keyboard Thru merges the notes not arpeggiated with the notes being produced by the arpeggiator. This gives the effect of two parts playing at once.

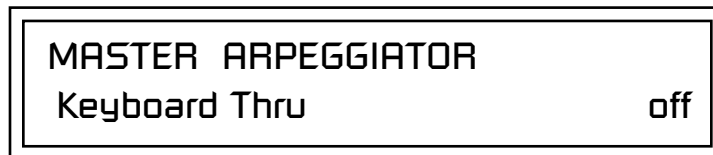

Latch

With Latch mode On, any notes you play remain on until you press them again. Latched notes can also be halted by turning Latch off in this screen, or by turning off the Arpeggiator for the channel in the main screen.

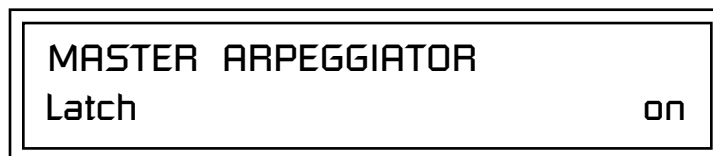

Key Range

Use the Key Range parameter to set the keyboard range for the arpeggiator. Notes inside the range will arpeggiate while notes outside the specified range will not arpeggiate. Use the Extensions parameters to exceed the upper boundary of the Key Range (see the information about Extensions beginning on page 54).

MASTER ARPEGGIATOR	
Key Range	C-2->G8

Move the cursor under the first key and use the Data Entry Control to define the lowest key to be arpeggiated. Move the cursor under the second key value and use the Data Entry Control to define the highest key to be arpeggiated.

Send MIDI System Exclusive Data

Transmits the Arpeggiator Patterns via the MIDI out port as MIDI System Exclusive data to another Mo'Phatt or to a computer/sequencer for backup. Using the cursor key and the Data Entry Control, select the MIDI data you want to transmit. See *Send MIDI System Exclusive Data* in the Master chapter for additional details about recording SysEx.

User Patterns

Transmits all the User patterns.

00⁰ to 99⁰

Transmits only the individual pattern you have selected.



Send data as you would a regular sequence. Sending data in one huge chunk may clog the MIDI input buffer on Mo'Phatt.

SEND MIDI SYSEX DATA	
<u>A</u>ll User Arp Patterns	

Editing a User Arpeggiator Pattern

Bank 0 = User Patterns
Bank 1 = Factory Patterns
Bank 2 = Factory Patterns

 Before editing a Pattern, select Master Arpeggiator (M) in the main screen and set the Arpeggiator to the Pattern you are editing. This lets you hear the Pattern as you edit it.

Mo'Phatt lets you create and edit your own arpeggiator patterns. Using the Edit User Pattern menu, you can create up to 100 user patterns and each pattern can be up to 32 steps in length.

When you edit a pattern, you are writing directly into memory—no Save command is required. This is different from the Edit menu where you must Save a preset before it will be overwritten. If you want to modify an existing pattern and keep the original, you must first COPY the pattern you want to edit to another location using the function in the Copy menu (See page 187). Refer to the instructions below and the following parameter descriptions to create your own patterns.

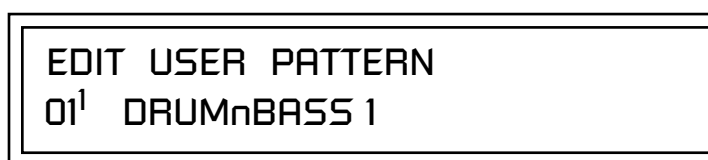

► To Select the Pattern to Edit

1. From the Edit User Pattern screen shown above, move the cursor to the bottom line and select the pattern you want to edit. The Enter LED begins flashing.
2. Press the Enter button to confirm that you want to edit the selected pattern. The “User Pattern Edit” page appears.

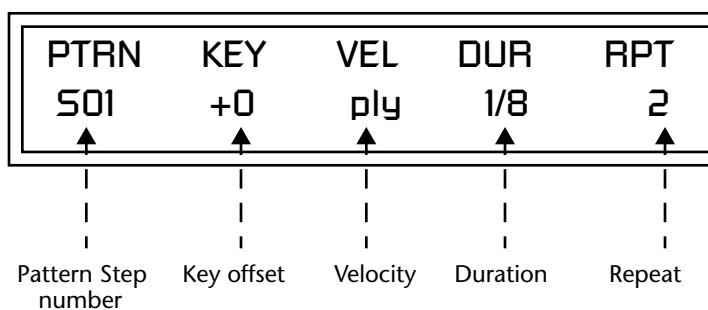

Pattern Step Number

You can set up to 32 steps for each arpeggiator pattern. This field selects which step you will be editing from 1 to 32.

Key

This parameter defines what happens during the current step. The Key parameter can do one of five different operations. Following is a description of each of the key functions and how to use them.

Key Offset

This parameter defines not the actual note of the arpeggiator playback, but instead specifies the amount of offset, in semitones, from the original note played. You can set a Key Offset from -48 to +48 for each step. For example, if you play a "C" on the keyboard with the Key Offset amount for the first step set to "+1," the first step in the pattern will be "C#."

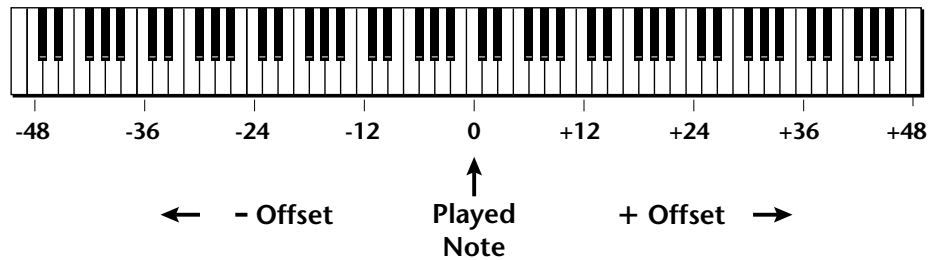

Tie

This function *extends* the duration of notes beyond the values given in the duration field by "tying" notes together. You can tie together any number of consecutive steps.



IMPORTANT: The Gate function in the arpeggiator *MUST* be set to 100% when using the tie function, otherwise the tied note is retriggered instead of extended.

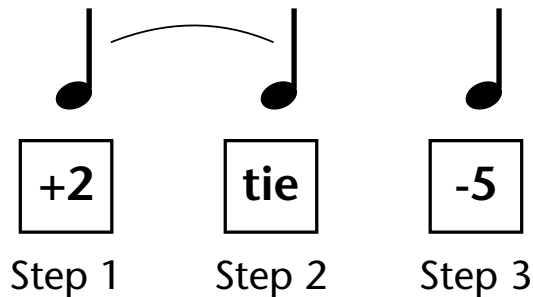

Rest

Instead of playing a note, you can define the step as a Rest. The Duration parameter specifies the length of the rest. Rests can be tied together to form longer rests.

Skip

This command simply removes the step from the pattern. The Skip feature makes it easy to remove an unwanted step without rearranging the entire pattern. You'll be happy to know that the velocity, duration and repeat parameters are remembered if you decide to put the step back later.

End

This command signals the end of the pattern. Any steps programmed after the step containing the End command are ignored.

Velocity

Each note in the pattern plays using either a preset velocity value (from 1 through 127), or using the actual velocity of the played note (ply).

Note: Velocity values will not have an effect on the sound unless velocity is programmed to do something in the preset.

Duration

This parameter sets the length of time for the current step, defined as a note value, based on the Master Clock Tempo. The selectable note durations are described below.

1/32	32nd Note	1/2t	Half Note Triplet
1/16t	16th Note Triplet	1/4d	Dotted Quarter Note
1/32d	Dotted 32nd Note	1/2	Half Note
1/16	16th Note	1/1d	Dotted Whole Note
1/8t	8th Note Triplet	1/1t	Whole Note Triplet
1/16d	Dotted 16th Note	1/2d	Dotted Half Note
1/8	8th Note	1/1	Whole Note
1/4t	Quarter Note Triplet	2/1t	Double Whole Note Triplet
1/8d	Dotted Eighth Note	2/1	Double Whole Note
1/4	Quarter Note		

Repeat

Each step can be played from 1 to 32 times. A repeat setting of “1” indicates the step will be played one time (not repeated one time or played twice).

► To Edit a User Pattern

1. The first field in the Edit User Pattern field defines the pattern’s step number. Start with the pattern Step 01.
2. Define the Key Offset, Velocity, Duration and Repeat values.
3. Repeat steps 1 and 2 until you have setup the desired number of steps in the pattern.
4. Set the Key Offset to “End” on the last step in the pattern.

User Pattern Name

The User Pattern Name page lets you enter a name for any User Arpeggiator Pattern.

<u>P</u> TRN	KEY	VEL	DUR	RPT
S01	+0	ply	1/8	2

► To Name a User Pattern

1. From the Pattern Edit screen shown above, position the cursor under the PTRN field.
2. Turn the Data Entry Control clockwise. The following screen appears.

<u>U</u> SER PATTERN NAME
00 ⁰ Mod Snow Peas

3. Move the cursor to the bottom line and edit the Pattern name using the Data Entry Control and Cursor keys.
4. Move the cursor to the “Home” position (shown above) by pressing the Home/Enter button, then turn the Data Entry Control counterclockwise one click to return to the Pattern Edit screen.
5. Turn the Data Entry Control counterclockwise multiple clicks to jump back to the main Arpeggiator menu screen.

Multi-Channel Arpeggiating

One of the coolest features in Mo'Phatt is its ability to run multiple arpeggiators at the same time. The interactions of multiple note sequences can be complex and fascinating. Mo'Phatt lets you run up to sixteen arpeggiator patterns at once! Even two or three patterns at once can create very complex sequences and dynamic landscapes of sound.

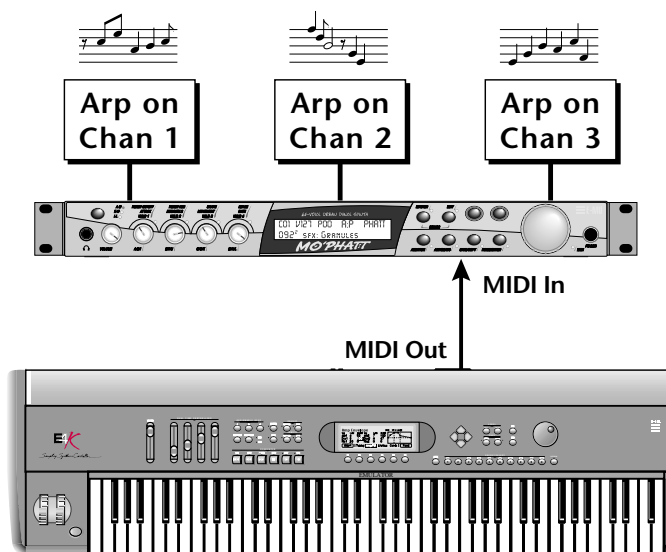

Master Keyboard transmitting on
MIDI channels 1, 2, 3

Here's one way to use this ultra-powerful feature. There is one arpeggiator for each MIDI channel. In order to arpeggiate on multiple channels, you need a controller that can output multiple MIDI channels at once.

1. Set up your MIDI keyboard so that it outputs the entire keyboard on MIDI channels 1 and 2. This procedure varies with the type of keyboard you own. Refer to the owner's manual that came with your keyboard for instructions.
2. Put Mo'Phatt into Multi mode. This is located in the Master menu, MIDI Mode page.
3. On the main screen, turn the arpeggiator "on" for MIDI channels 1 and 2. (We're only using two channels for now to keep it simple.) Select a different preset for each MIDI channel while you're at it.

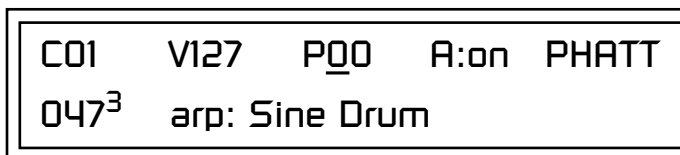

4. Start playing. You should be hearing two arpeggiators playing at once.

Try experimenting with presets and settings. For example:

- Change presets on one or both of the MIDI channels you are using (1 & 2). Since each factory preset has different arpeggiator settings, changing the preset not only changes the sound, but the arpeggiator settings as well.
- Press the Control button on the front panel to select “I-L” (the LED in the third row is illuminated). Adjust the front panel control knobs. These knobs usually control the arpeggiator on presets with the “arp:” prefix.
- Try changing one of the channel’s arpeggiator setting to “M” instead of “on.” Now press the Arpeggiator Menu button and adjust the arpeggiator parameters in real time.
- From the Master Arpeggiator menu, set the Mode to Pattern then explore the different patterns. There are 300 patterns available!

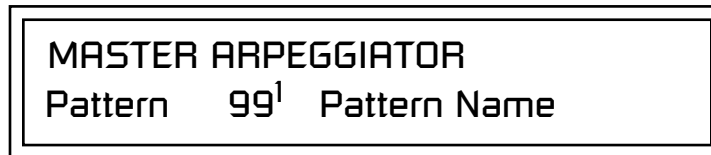

Now you’re getting the picture. This machine is beyond awesome!

Using a MIDI Interface to Channelize Data

Not all keyboards or controllers can transmit on multiple MIDI channels at once. If your MIDI controller only transmits on a single MIDI channel, there are other ways to use the multi-channel arpeggiators. A MIDI interface such as Mark of the Unicorn’s MIDI Time Piece®, or a MIDI router box will convert data on one channel to any other channel or channels.

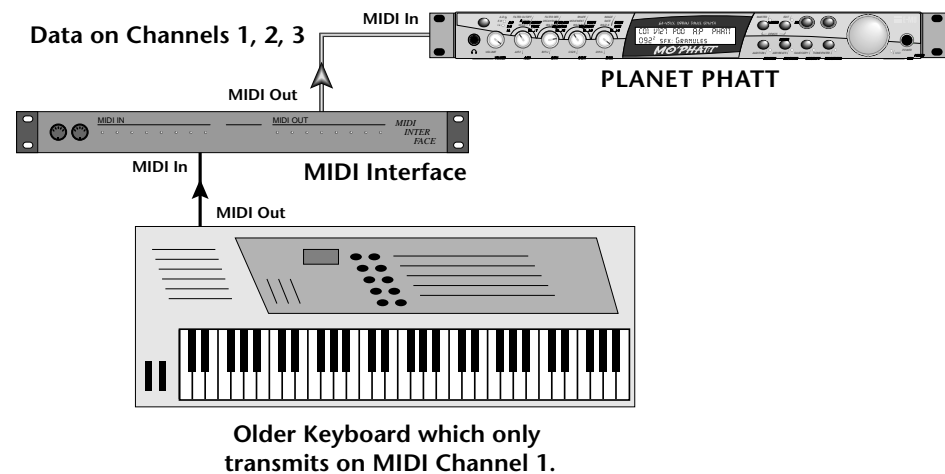

Your MIDI Interface may be able to output MIDI data on multiple channels at once.

Master Menu

The Master menu contains functions that affect the overall operation of Mo'Phatt. For example, changing the Master Tune parameter changes the tuning of all the presets, not just the one currently displayed.

▶ **To enable the Master menu**

Press the Master button, lighting the LED. The Master Menu screen displays the menu page most recently selected since powering up Mo'Phatt. The cursor appears below the first character of the screen heading on line one.



Warning: Master Menu changes are automatically saved when you exit the menu. If the power is turned off before you exit the menu any changes you have made will be lost.

▶ **To select a new screen**

Press the Home/Enter button or press the Cursor button repeatedly until the cursor is below the screen title heading. Rotate the Data Entry Control to select another screen.

▶ **To modify a parameter**

Press either Cursor button repeatedly (or hold down the right cursor button while turning the Data Entry Control) until the cursor is below the desired parameter value. Rotate the Data Entry Control to change the value.

▶ **To return to the main screen**

Press the Master button, turning off the LED.

Defining Master Parameters

Transpose/Tune

Master setup parameters affect overall performance, range, and global effects. This section describes the Master parameters and how to define them.

The Transpose parameter transposes the key of all presets, in semitone intervals. The transpose range is ± 24 semitones.

Master Tune adjusts the fine tuning of all presets so that you can tune Mo'Phatt to other instruments. The master tuning range is ± 1 semitone in 1/64th semitone increments (1.56 cents). A master tune setting of "+00" indicates that Mo'Phatt is perfectly tuned to concert pitch (A=440 Hz).

MASTER TRANSPOSE +00 semitones	TUNE +00
--	--------------------

Bend Range

The Bend Range parameter sets the range of the pitch wheel. This affects only presets that have their individual Pitch Bend range (defined in the Edit menu) set to Master. The maximum pitch bend range is ± 12 semitones or one octave in each direction.

MASTER BEND RANGE +/- 7 semitones

Velocity Curve

You can modify incoming velocity data by a velocity curve in order to provide different types of dynamics in response to your playing, or to better adapt to a MIDI controller. The Master Velocity Curve lets you select one of thirteen master velocity curves or to leave the data unaltered (linear).

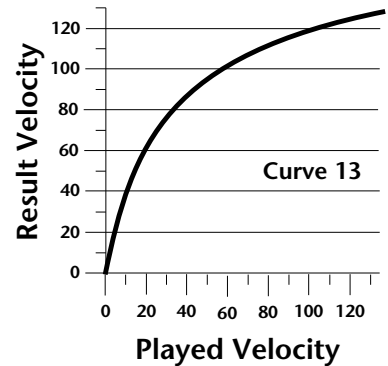
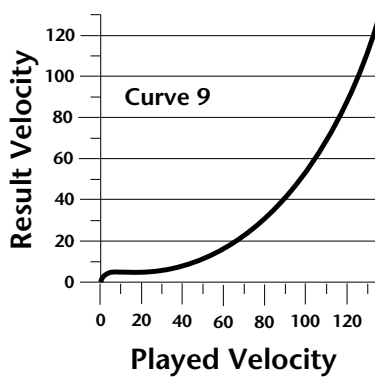
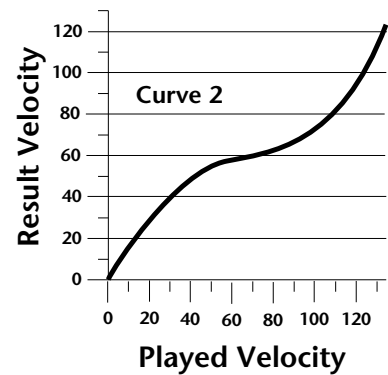
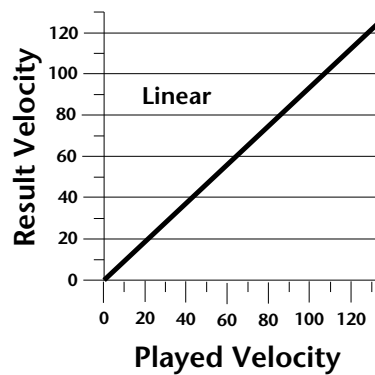
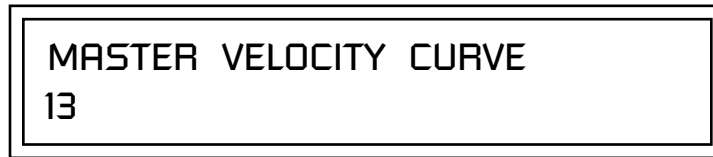

For a complete list of all available velocity curves, see “Velocity Curves” on page 220 of the Appendix.

Mix Output

The Mix Output parameter allows you to override the routing assignments made in each preset and instead assign the outputs according to MIDI channel. For each of the 16 MIDI channels, you can select Send 1-4, or Preset. When Preset is selected, the output assignment defined in the Preset Edit menu is used.

MIX OUTPUT
channel 16: use preset

MIX OUTPUT
channel 15: Send 1

The *Sends* function as effect processor inputs (effect sends). The four Effect Sends allow you to get the most out of the two effect processors. For example, with Effect B set to an echo algorithm, you could route one MIDI channel to Send 3 and set the effect amount to 80%. Another MIDI channel could be routed to Send 4 with an effect amount of only 5%. This is almost like having two different effects!

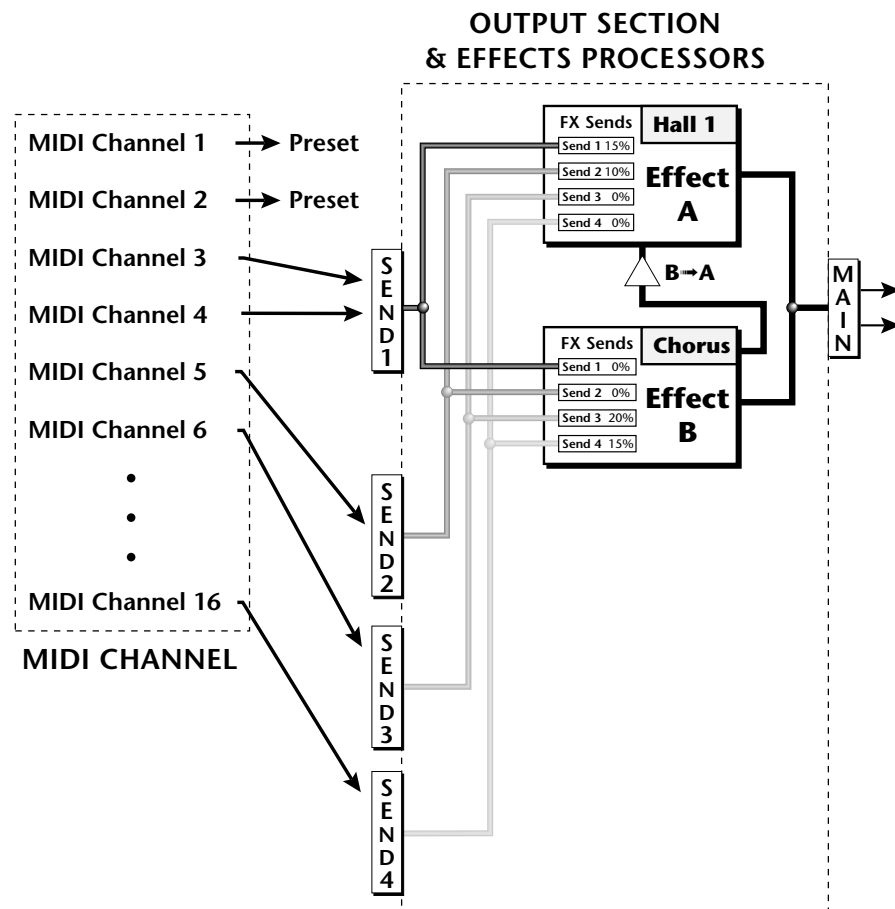

Master Effects

The digital effect processors can be programmed as part of the preset (using the Edit menu) so that effects will change along with the preset. However, there are only two effect processors, and so you cannot have a different effect on each preset when in Multi mode.

The Master Effects settings assign the effect processors “globally” for all presets to provide a way to use the effects in Multi mode. Detailed information is presented in the Effects chapter (see Effects on page 169).

Effects Mode

The FX Mode page enables or bypasses the effects. When the FX Mode is set to “bypass,” the effects are turned off on a global scale. This includes Effects programmed in the preset.

FX MODE
enabled

Effects Multi Mode Control

The routing scheme for the two stereo effects processors provides a lot of versatility. When in multi mode, you can “use master settings” which applies the Master menu effects settings to all 16 MIDI channels.

FX MULTIMODE CONTROL
use master settings

If you want more control, you can use the “channel” setting which applies the effects settings of the preset on a specified channel to all the other channels. Changing the preset on the specified channel changes the effect.

FX MULTIMODE CONTROL
preset on channel 1

If you are in Omni or Poly modes this parameter is disabled and the message in parentheses explains that Mo’Phatt is currently in Omni mode.

FX MULTIMODE CONTROL
(using Omni mode)

Master FXA Algorithm

This function selects the type of effect used for the “A” effect. The following effect types are available.

MASTER FXA ALGORITHM

Room 1

A Effect Types

- | | |
|---------------------|-----------------------|
| 1. Room 1 | 23. BBall Court |
| 2. Room 2 | 24. Gymnasium |
| 3. Room 3 | 25. Cavern |
| 4. Hall 1 | 26. Concert 9 |
| 5. Hall 2 | 27. Concert 10 Pan |
| 6. Plate | 28. Reverse Gate |
| 7. Delay | 29. Gate 2 |
| 8. Panning Delay | 30. Gate Pan |
| 9. Multitap 1 | 31. Concert 11 |
| 10. Multitap Pan | 32. Medium Concert |
| 11. 3 Tap | 33. Large Concert |
| 12. 3 Tap Pan | 34. Large Concert Pan |
| 13. Soft Room | 35. Canyon |
| 14. Warm Room | 36. DelayVerb 1 |
| 15. Perfect Room | 37. DelayVerb 2 |
| 16. Tiled Room | 38. DelayVerb 3 |
| 17. Hard Plate | 39. DelayVerb 4 Pan |
| 18. Warm Hall | 40. DelayVerb 5 Pan |
| 19. Spacious Hall | 41. DelayVerb 6 |
| 20. Bright Hall | 42. DelayVerb 7 |
| 21. Bright Hall Pan | 43. DelayVerb 8 |
| 22. Bright Plate | 44. DelayVerb 9 |

*FXA Parameters:
Decay/HF Damping
FxB -> FxA*

This page lets you define the parameters of the selected Effects algorithm. Use this page to setup the effect decay, high frequency damping amount and to route "B" effects through the "A" effects. See "Effect Parameters" on page 171 for more details.

FXA	DECAY	HFDAMP	FxB>FxA
	040	096	001

FXA Send Amounts

These parameters set the effects amounts for each of the four stereo effects busses. See "Master Effects" on page 174 for detailed information.

FXA SEND AMOUNTS	1:100%
2: 50%	3: 10%
	4: 0%

*Master FxB
Algorithm*

This parameter selects the type of effect used for the "B" effect. The following effect types are available.

MASTER FxB ALGORITHM
Chorus 1

B Effect Types

- | | |
|----------------|------------------------|
| 1. Chorus 1 | 17. Ensemble |
| 2. Chorus 2 | 18. Delay |
| 3. Chorus 3 | 19. Delay Stereo |
| 4. Chorus 4 | 20. Delay Stereo 2 |
| 5. Chorus 5 | 21. Panning Delay |
| 6. Doubling | 22. Delay Chorus |
| 7. Slapback | 23. Pan Delay Chorus 1 |
| 8. Flange 1 | 24. Pan Delay Chorus 2 |
| 9. Flange 2 | 25. Dual Tap 1/3 |
| 10. Flange 3 | 26. Dual Tap 1/4 |
| 11. Flange 4 | 27. Vibrato |
| 12. Flange 5 | 28. Distortion 1 |
| 13. Flange 6 | 29. Distortion 2 |
| 14. Flange 7 | 30. Distorted Flange |
| 15. Big Chorus | 31. Distorted Chorus |
| 16. Symphonic | 32. Distorted Double |

FXB Parameters: Feedback/LFO Rate Delay Time

The FXB parameters setup the characteristics of the effect. Use this page to define the feedback amount, the LFO rate and delay amount for the selected type “B” effect. See “Effect Parameters” on page 171 for details.

FXB	FEEDBK	LFORATE	DELAY
	000	003	0

FXB Send Amounts

These parameters set the effects amounts for each of the four stereo effects busses. See the Effects chapter for detailed information.

FXB SEND AMOUNTS	1:100%
2: 50%	3: 10%
	4: 0%

MIDI Parameters

MIDI Mode

MIDI parameters control how the Mo'Phatt sends and receives MIDI data.

MIDI Mode selects one of the three MIDI modes: Omni, Poly or Multi mode.

MIDI MODE	CHANGE
omni	ignored

The **MIDI Mode Change** parameter specifies whether mode changes made through an external MIDI controller are accepted or ignored.

The MIDI modes are as follows:

Omni

Responds to note information on all MIDI channels and plays the preset currently displayed in the main screen.

Poly

Responds only to note information received on the currently selected MIDI channel (on the preset selection screen) and plays that channel's associated preset.

Multi

Responds to data on any combination of MIDI channels and plays the specific preset associated with each of the MIDI channels. You must select multi mode for multitimbral operation.

MIDI SysEx ID



WARNING: When transferring SysEx data from one Mo'Phatt to another, the ID numbers of both units must be the same.

This page defines the MIDI system exclusive (SysEx) device ID number. The SysEx ID lets an external programming unit to distinguish between multiple Mo'Phatt units connected to the same preset editor. In this case each unit must have a unique SysEx ID number.

MIDI SYSEX ID
000

MIDI Enable

MIDI Enable lets you turn each MIDI channel on and off independently when in Multi mode. This feature is helpful when you have other devices connected to the same MIDI line and do not want the Mo'Phatt unit to respond to the MIDI channels reserved for the other devices.

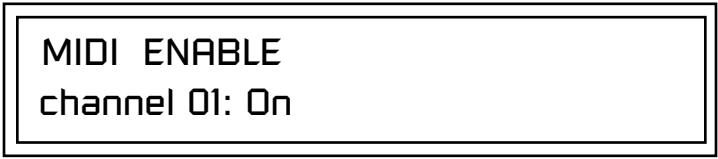

Because the MIDI Enable function only makes sense if you are in Multi mode, Mo'Phatt disables this feature when in Omni or Poly mode.

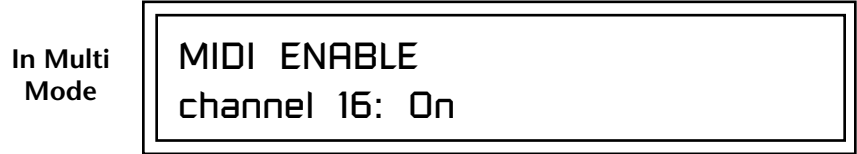

MIDI Program Change -> Preset

You can also remap incoming MIDI program changes to a different numbered preset. This is a handy feature when your master keyboard cannot send a bank change or you want to reorder preset numbers. Any preset can be mapped to any incoming MIDI program change number.

For example, you could set up the Program -> Preset map to call up preset #12 whenever Mo'Phatt receives MIDI program change #26.

The four fields shown below are editable.

 The Program->Preset Change only works for program changes received in Bank 0.

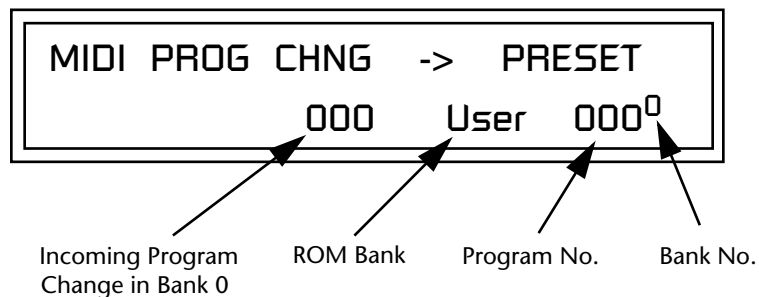

 Programs and presets are the same thing. "Preset" is E-MU's term for MIDI Program.

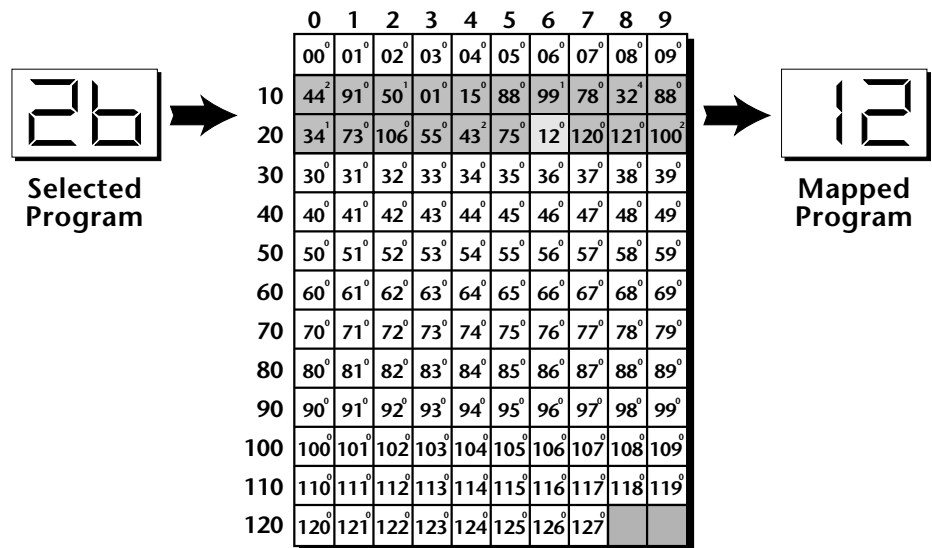

In this chart, program changes 10-29 have been remapped to new preset numbers. All other presets are selected normally.

Receive Program Change

Use this function to instruct the Mo'Phatt to utilize or ignore incoming MIDI preset changes or Bank Select commands for each channel. Use the cursor buttons to select the channel number field, then use the Data Entry Control to select a channel number. Use the cursor button again to select the On/Off field and the Data Entry Control to change the value.

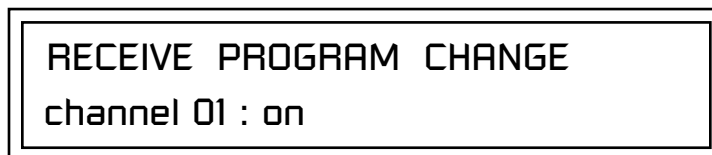

Real-time Controller Assignment

Use these three pages to assign twelve real-time control sources. Each MIDI Controller is assigned a letter (A - L). The front panel Controller Knobs and twelve MIDI controller numbers share the A-L controller routings. **These screens let you select which MIDI real-time controllers numbers will be received (from 1 to 31 and from 64 to 119) and which controller numbers will be transmitted over MIDI if the front panel controls are turned.** The PatchCord routing and amount in the Edit menu determine what effect the controller has on each preset. Real-time controllers are shown in the PatchCord menu as MIDI A through MIDI L.



Mo'Phatt factory presets have certain synth parameters assigned to each controller letter and so these are "Global" controller assignments.

For example, assigning a MIDI controller to "A" in this screen would let you control filter Fc for all the factory presets. See "Front Panel Knob Functions" on page 195.

The Real-time Controller assignment also specifies which controller numbers are transmitted when the "Knobs MIDI Out" is enabled (see "Knobs/Riff MIDI Out" on page 78).

REALTIME CONTROLLER #			
A: 21	B: 22	C: 23	D: 24

REALTIME CONTROLLER #			
E: 25	F: 26	G: 27	H: 28

REALTIME CONTROLLER #			
I: 80	J: 81	K: 91	L: 93

Note: Controllers 7 and 10 are already assigned to Volume and Pan for each MIDI channel. Controllers 91 & 93 are the standard controller numbers for reverb and chorus send amounts.

Following are a few of the standardized MIDI Controller numbers as defined by the MIDI manufacturers association. The controllers shown in **Bold** are automatically routed to the destination (volume & pan) or have their own PatchCord source. Others, such as Portamento Time, can be routed using a PatchCord to have the desired effect.

- | | |
|-----------------------------|------------------------|
| 1 - Modulation Wheel | 7 - Volume |
| 2 - Breath Controller | 8 - Balance |
| 3 - Old DX7 Aftertouch | 9 - Undefined |
| 4 - Foot Pedal | 10 - Pan |
| 5 - Portamento Time | 11 - Expression |
| 6 - Data Entry | |

MIDI Footswitch Assign

Like the MIDI Controllers, you can assign three MIDI footswitches to MIDI footswitch numbers. Footswitches numbers are from 64-79. Destinations for the footswitch controllers are programmed in the PatchCord section of the Edit menu.

FOOTSWITCH CONTROLLER #		
1: 64	2: 65	3: 66

Following are a few of the standardized MIDI Switch numbers.

64 - Sustain Switch (on/off)	67 - Soft Pedal (on/off)
65 - Portamento (on/off)	69 - Hold Pedal 2 (on/off)
66 - Sostenuto (on/off)	

Tempo Controller



See "Base Tempo (Master Clock)" on page 36.

This function allows a MIDI controller to change the Base Tempo of the Master Clock. The Master Clock is used for the clock divisor PatchCords, tempo-based envelopes and synced LFOs. (See "Clock Modulation" on page 90.) You can assign any controller number from 0-31, mono key pressure, or the pitch wheel to change the Base Tempo.

A different controller can be used to change the tempo up or down. The Pitch Wheel can be assigned to both the up and down parameters to vary the tempo up and down from a single controller. If any other controller is assigned to both the up and down parameters, Mo'Phatt redefines the center of the controller's range as zero (so it acts like a pitch wheel).

MIDI Controller values are added to the Base Tempo with a range of ± 64 . When the controller is set to "off" the tempo returns to its original setting. This control has no effect when using an external clock.

TEMPO CONTROLLER#	CHAN
Up: 03 Down: 09	16

Knob Preset Quick-Edit



Quick Edit does not work while in the Edit menu with "Knobs Deep Edit" enabled.

"Quick-Edit" changes the initial controller setting in the preset whenever you move a Control Knob. This parameter selects whether or not the front panel Controller Knobs are used to Quick-Edit the currently selected preset. See "Real-time Control" on page 27 in the Operations chapter for more details.

<p>KNOBES PRESET QUICK-EDIT disabled</p>

*Knobs
Deep Edit*

This parameter specifies whether or not the front panel controller knobs can be used to edit parameter values in the Master or Edit menus. This is called “Deep-Editing.” With Knob Deep Edit disabled, the front panel controller knobs retain their function as real-time controllers even when in the Master or Edit modes.

KNOBS DEEP EDIT
disabled

Knobs/Riff MIDI Out

This function allows you to select whether or not MIDI controller data is transmitted when you turn the front panel Controller knobs. The knobs transmit on the controller numbers defined by the Real-time Controller Assign parameter (see page 75). This function also enables or disables transmission of Riff note data over MIDI when the Audition button is pressed.

If Deep Edit is enabled, “Knobs MIDI Out” does not work while in any of the editing menus (Master, Edit, Save/Copy).

KNOBS/RIFF MIDI OUT
don't transmit

*Preset Edit All Layers
Enable*

This function allows you to turn the Edit All Layers feature on or off. “Edit All Layers” is an Edit menu feature which allows you to select all layers (A) in order to edit all four layers simultaneously. Because this feature can be confusing to the beginning programmer, it can be disabled here in the Master menu. Check this feature out when you’re ready. It’s great!

PRESET EDIT ALL LAYERS
enabled

Front Panel Knob Calibration

This function calibrates the minimum and maximum values for the five front panel knobs. The controls should be calibrated periodically in order to compensate for normal wear and tear on the controls themselves or if the controls behave strangely. Before calibration, it's usually a good idea to let the unit warm up for about half an hour to ensure you have the maximum range on all the front panel controls.

► To Calibrate the Front Panel Control Knobs

1. Press the Master menu button and advance to the Calibrate Knobs page.

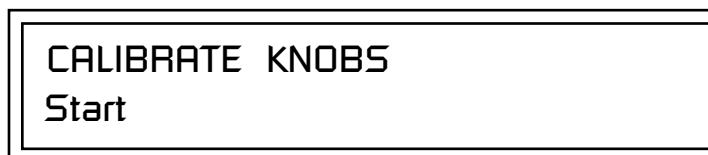

CALIBRATE KNOBS
Start

2. Press the Enter button to begin the calibration process. The following screen appears.

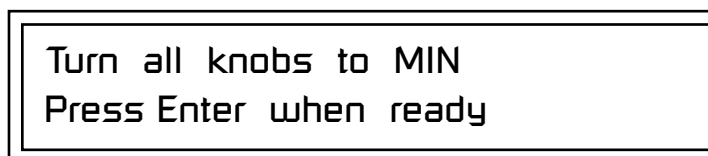

Turn all knobs to MIN
Press Enter when ready

3. Turn all knobs to their minimum value (which is pegged in the counter-clockwise direction), then press the Enter button. The screen briefly flashes, "Reading Values...", then displays:

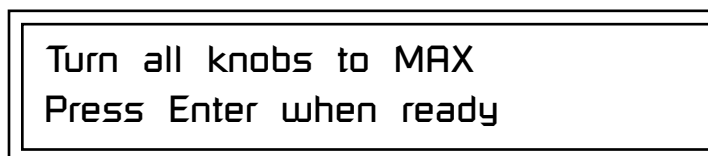

Turn all knobs to MAX
Press Enter when ready

4. Turn all knobs to their maximum value (pegged in the clockwise position), then press the Enter button. The display shows, "Reading Values... Done." Calibration is complete.

MIDI SysEx Packet Delay

Sometimes errors occur if the computer or sequencer to which you are sending MIDI SysEx data is faster or slower than the Mo'Phatt. The MIDI SysEx Packet Delay command lets you specify the amount of delay between MIDI SysEx packets so the input buffer of your computer does not overflow, causing an error. The value range is from 0 through 8000 milliseconds. A delay value of zero allows full speed MIDI transfer. If you are experiencing data transmission errors, try increasing the delay value until the problem disappears.

MIDI SYSEX PACKET DELAY
300 milliseconds

Send MIDI System Exclusive Data

This command transmits MIDI System Exclusive (SysEx) data to the MIDI Out port of Mo'Phatt. The MIDI data can be sent to a computer, sequencer or to another Mo'Phatt. When transferring data between two Mo'Phatts be sure both units have the same SysEx ID number! See "MIDI SysEx ID" on page 73 to learn how to change the SysEx ID.

Using the cursor key and the Data Entry Control, select the type of MIDI data you want to transmit. Following are descriptions of the types of MIDI data that can be transmitted.

Current Multisetup

Transmits all parameters in the Master menu except Tuning Tables, Program/Preset Map and Viewing Angle.

Program /Preset Map

Transmits the MIDI Program -> Preset Map.

All User Tuning Tables

Transmits all 12 user User Tuning Tables.

Multimode Map

Transmits the following parameters:

- Multimode Basic Channel
- Multimode Effects Control Channel
- Multimode Tempo Control Channel

and for each MIDI Channel...

- Preset, Volume, & Pan
- Mix Output
- Multimode Channel Enable
- Multimode Bank Map
- Multimode Receive Program Change



The Preset, Volume, and Pan information for all 16 channels is included when the Multi mode Map settings are transmitted or received.



WARNING: When transferring SysEx data from one Mo'Phatt to another, the ID numbers of both units must match.

Bank 0 User Presets

Transmits all the user defined presets in Bank 0.

Bank 1 User Presets

Transmits all the user defined presets in Bank 1.

Bank 2 User Presets

Transmits all the user defined presets in Bank 2.

Bank 3 User Presets

Transmits all the user defined presets in Bank 3.

Any Individual Preset

Transmits only the selected preset.

All User Arp Patterns

Transmits all user arpeggiator patterns.

All User Data

Transmits ALL: user presets, user tuning tables, user arp patterns, and user multisetups.

The Enter LED will be flashing. Press the Enter button to confirm the operation. To receive MIDI data, simply send the MIDI data into Mo'Phatt from another Mo'Phatt or from a computer/sequencer.

SEND MIDI SYSEX DATA
bank 1 user presets

► To Record MIDI SysEx Data into a Sequencer:

1. Setup the sequencer to receive system exclusive data.
2. Place the sequencer into record mode, then Send MIDI Data.

► To Receive MIDI SysEx Data from a Sequencer:

Simply play back the sequence containing the SysEx data into Mo'Phatt.

User Key Tuning

 The user key tuning can be used to tune individual percussion instruments.

User Key Tuning lets you create and modify 12 user definable tuning tables. The initial frequency of every key can be individually tuned, facilitating the creation of alternate or microtonal scales.

Using the cursor keys and the Data Entry Control, select the user table number, the key name, the coarse tuning and the fine tuning. The key name is variable from C-2 to G8. Coarse Tuning is variable from 0 to 127 semitones. The fine tuning is variable from 00 to 63 in increments of 1/64 of a semitone (approx. 1.56 cents). For each preset, the specific tuning table is selected in the Edit menu.

USER KEY TUNING	Table: 1
Key: C1	Crs: 036
	Fine: 00

Screen Viewing Angle

This function changes the viewing angle of the display so that you can read it easily from either above or below the unit. The angle is adjustable from +7 to -8. Positive values will make the display easier to read when viewed from above. Negative values make the display easier to read from below.

VIEWING ANGLE
+0

Programming Basics

This chapter explains how Mo'Phatt sounds are constructed and contains important background information on how to create your own custom presets.

Your initial involvement with Mo'Phatt will most likely be using the existing presets and selecting MIDI channels. While the factory presets are very good, there are some things you will probably want to change eventually, perhaps the LFO speed, the filter frequency or the attack time. You may also want to make your own custom presets using complex modulation routings. This module will do far more than you ever imagined and there are whole new classes of sound just waiting to be discovered.

Each preset can consist of up to four instrument layers. Each of the four layers can be placed anywhere on the keyboard and can be crossfaded or switched according to key position, velocity, or by using a real-time control such as a wheel, slider, pedal, LFO or envelope generator. A preset can also be "linked" with up to 2 more presets creating additional layering or splits.

Mo'Phatt has an extensive modulation implementation using two multi-wave LFO's (Low Frequency Oscillators), three multi-stage envelope generators and the ability to respond to multiple MIDI controllers. You can simultaneously route any combination of these control sources to multiple destinations.

There are 512 user locations (USER Banks 0-3) available to store your own creations or edited factory presets. It's easy and fun to edit or create your own unique presets.

Modulation

To modulate means to dynamically change a parameter, whether it be the volume (amplitude modulation), the pitch (frequency modulation), and so on. Turning the volume control on your home stereo rapidly back and forth is an example of amplitude modulation. To modulate something we need a modulation source and a modulation destination. In this case, the source is your hand turning the knob, and the destination is the volume control. If we had a device that could turn the volume control automatically, we would call that device a modulation source.

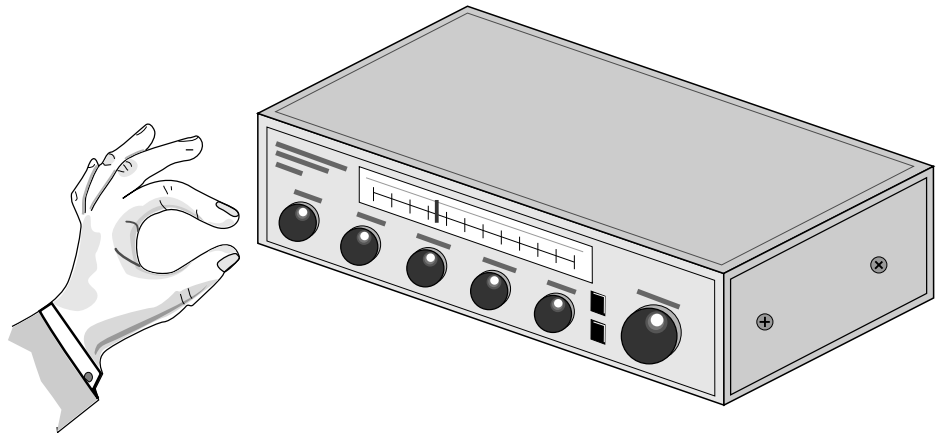

Turning the volume control back and forth on your home stereo is an example of Amplitude Modulation.

Mo'Phatt is designed so that each of the variable parameters, such as the volume, has an initial setting which is changed by a modulation source. Therefore in the case of volume, we have an initial volume that we can change or modulate with a modulation source.

Two main kinds of modulation sources on Mo'Phatt are *Envelope Generators* and *Low Frequency Oscillators*. In the example above, an envelope generator could be routed to automatically turn the volume control as programmed by the envelope. Or, a low frequency oscillator could be routed to turn the volume up and down in a repeating fashion.

Positive modulation adds to the initial amount. Negative modulation subtracts from the initial amount.

Summing Nodes

All the modulation inputs on Mo'Phatt are summing nodes. This means that you can connect as many modulation sources as you want to an input (such as *Pitch* or *AmpVol*). Modulation sources are simply added algebraically—connecting two knobs one set to -100 and the other set to +100 yields a net value of zero.

Modulation Sources



Tip: Try routing Key Glide to Filter Frequency if you want the filter to smoothly follow pitch in solo mode. Routing Key Glide to Pan creates another interesting effect.

Modulation sources include *Envelope Generators*, *Performance Controllers* and *Low Frequency Oscillators*. In the previous example, an envelope generator was routed to automatically turn the volume control as programmed by the envelope, or, a low frequency oscillator could be routed to turn the volume control up and down in a repeating fashion. The following is a list of the modulation sources used in Mo'Phatt.

Keyboard Key

Which key is pressed.

Key Velocity

How fast the key is pressed.

Release Velocity

How fast the key is released.

Gate

High if the key is pressed, low when the key is released.

Key Glide

A smoothly changing control source based on the Glide Rate and the interval between the last two notes played.

Pitch and Mod Wheels

Synthesizer pitch bend and modulation wheels.

Keyboard Pressure (mono aftertouch)

Key Pressure applied after the key is initially pressed.

Pedal

A continuously variable pedal controller.

Miscellaneous Controllers A -L

Any type of MIDI continuous controller data.

Low Frequency Oscillators (2 per layer)

Generate repeating waves.

Envelope Generators (3 per layer)

Generate a programmable "contour" which changes over time when a key is pressed.

Noise & Random Generators

Generate spectrums of noise and random signals.

Footswitches

Change a parameter when the switch is pressed.

Clock Divisor

The master clock can be divided and used as a modulation source.

Random Sources

Random modulation sources can be used when you want the timbre of the sound to be “animated” in a random or non-consistent manner.

- **Key Random 1 & 2** generate different random values for each layer which do not change during the note.
- The **White & Pink Noise** Generators produce varying random values. Both white and pink noise sources are low frequency noise designed for control purposes. Either noise source can be filtered even more by passing it through a lag processor.
- The **Crossfade Random** function generates the same random value for all layers in a preset. This source is designed to be used for cross-fading and cross-switching layers, although you may find other uses.

Modulation PatchCords

 The controller Knobs assignments printed on the front panel are the system defaults. You can change any of these assignments using the Real-time Controller Assignment page in the Master menu (see page 75 for details).

When setting up modulation with the Mo’Phatt, you define a modulation source and a modulation destination. Then, you connect the source to the destination using “PatchCords.” Mo’Phatt’s PatchCords are connected in the software. Mo’Phatt has 24 general purpose PatchCords for each layer.

You can connect the modulation sources in almost any possible way to the modulation destinations. You can even modulate other modulators. Each PatchCord also has an amount parameter which determines “how much” modulation is applied to the destination. The modulation amount can be positive or negative. Negative values invert the modulation source.

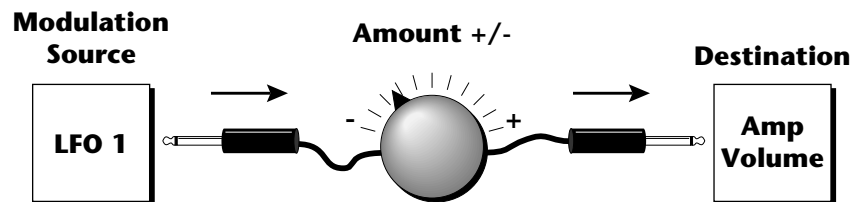

Envelope Generators



If two adjacent segments have the same level in a "time-based" envelope, the segment will be skipped. Adjacent segments must have different levels for the rate control to work.

An envelope can be described as a "contour" which is used to shape the sound over time in a pre-programmed manner. There are three envelope generators per layer and all of them are the rate/level type.

This is how the rate/level (*time based*) envelopes work: When a key is pressed, envelope starts from zero and moves toward the Attack 1 Level at the Attack 1 Rate. As soon as it reaches this first level, it immediately begins the next phase and moves toward the Attack 2 level at the Attack 2 rate. As long as the key is held down, the envelope continues on through the Decay 1 and Decay 2 stages. If the key is still held when the envelope reaches the end of Decay 2, it simply waits there for you to release the key. When you release the key, the envelope continues into the Release 1 and Release 2 stages, stopping at the end of the Release 2 stage. Mo'Phatt's envelope generators provide great flexibility for programming both complex and simple envelopes.

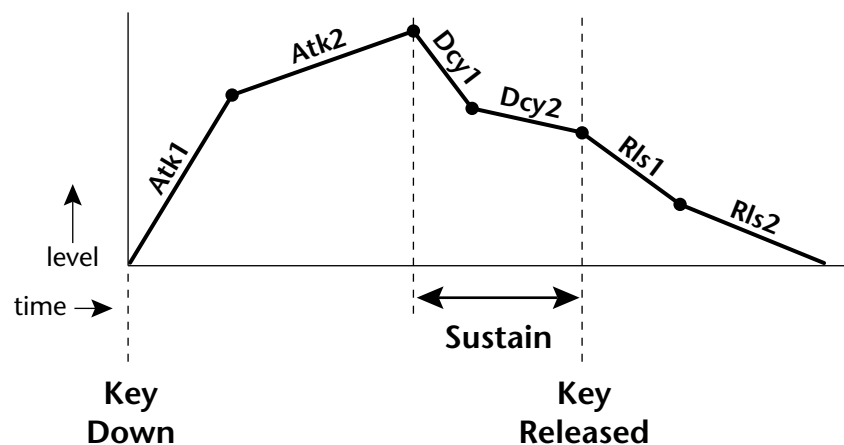

All three envelope generators have the six stages described above. The Volume Envelope generator controls the volume of the voice over time. The Filter Envelope generator is a general purpose envelope most often used to control the filter frequency. Unlike the Volume Envelope, however, the Filter Envelope can have a negative level value as well as a positive level. There is also an Auxiliary Envelope generator which is a general purpose envelope. The Auxiliary Envelope is identical to the Filter Envelope and can have negative as well as positive levels. You can adjust the time of each stage to create myriad envelope shapes, which in turn shape the sound over time.



By routing the Auxiliary or Filter Envelopes to control the pitch (PatchCords) you can easily hear the shape of the envelopes you are creating.

- Volume envelopes contour the way the volume of a sound changes over time determining how we perceive that sound. For example, a bell struck with a hammer is instantly at full volume, then slowly dies away. A bowed violin sound fades in more slowly and dies away slowly. Using Mo'Phatt's Volume Envelope, you can simulate the different types of natural instrument volume envelopes by programming them appropriately.

Tempo-based Envelopes

Tempo-based envelopes are based on *Time* which is controlled by the Master Clock (*located in the Arp/Beats menu*). The Master Clock rate scales the time of the Tempo-based envelope segments. The Master Clock can also be set to use an external MIDI clock so that the envelope times can be synchronized to external sequencer or arpeggiator tempo changes.

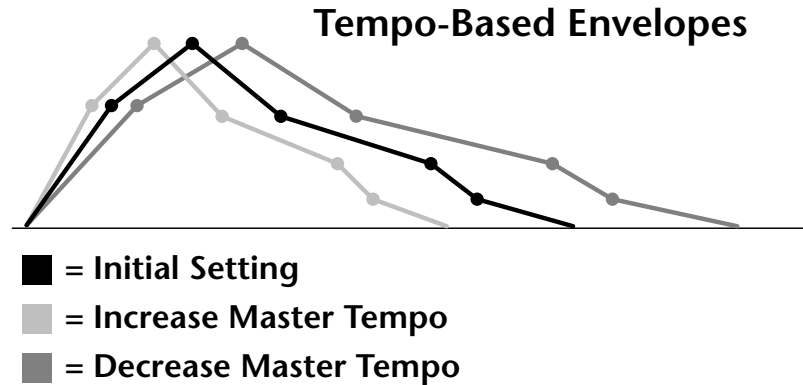

Envelope Repeat

The Envelope Generators can also be made to repeat. When the envelope repeat function is On, the Attack (1&2) and Decay (1&2) stages will continue to repeat as long as the key is held. As soon as the key is released, the envelope continues through its normal Release stages (1 & 2).

 Only the Filter and Auxiliary Envelopes have the repeating feature.

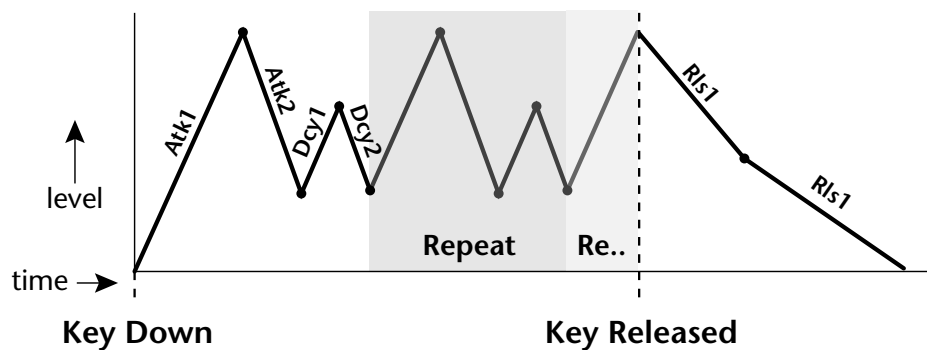

The diagram above show how the looping envelopes work. When the key is pressed the envelope goes through its regular Attack 1, Attack 2, Decay 1 and Decay 2 stages. In non-looping mode, the envelope would hold at the end of the Decay 2 stage until the key was released. In looping mode however, it jumps back to the Attack 1 stage and repeats the first four stages. It continues to loop through these four stages until the key is released where it immediately jumps to the Release 1 stage.

Low Frequency Oscillators (LFOs)

LFO Tricks & Tips:

- The Random LFO wave is truly random and is different for each voice and layer.
- The Pattern (Pat) waveforms will sound the same on different layers and voices.
- Sine + Noise is very useful for simulating trumpet and flute vibrato.

★ When routing Hemi-quaver to Pitch:

- +38 = major scale
- 38 = phrygian scale
- +76 = whole tone scale
- (+38) + (+76) = diminished (two cords)
- odd amount = S+H sound

Note: References to musical intervals in the pattern LFO shapes are with the LFO routed to pitch and a PatchCord amount of +38.

 Try combining the Pattern LFOs, or controlling the amount of one with another, or combining them with the clock divisors.

A Low Frequency Oscillator or LFO is simply a wave which repeats at a slow rate. The Mo'Phatt has two multi-wave LFOs for each channel. The LFO waveforms are shown in the following illustration.

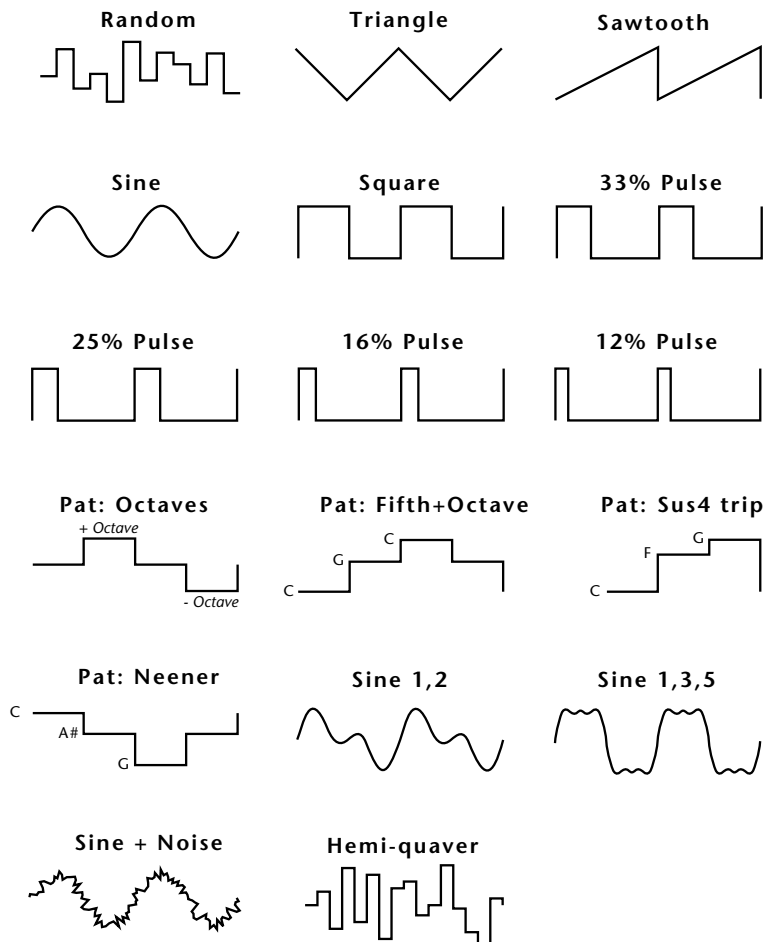

By examining the diagram of the LFO waveforms, you can see how an LFO affects a modulation destination. The shape of the waveform determines the result. Suppose we are modulating the pitch of an instrument. The sine wave looks smooth, and changes the pitch smoothly. The square wave changes abruptly and abruptly changes from one pitch to another. The sawtooth wave increases smoothly, then changes back abruptly. The sound's pitch follows the same course. Controlling the pitch of an instrument is an easy way to hear the effects of the LFO waves.

Like the Auxiliary Envelope, LFOs can be routed to control any real-time function such as Pitch, Filter, Panning, or Volume. A common use for the LFO is to control the pitch of the sound (LFO -> Pitch). This effect is called vibrato and is an important performance effect. Many presets use this routing with the modulation wheel controlling "how much" LFO modulation is applied. Another common effect, Tremolo, is created by controlling the volume of a sound with the LFO (LFO -> Volume).

You might use the LFOs to add a slight bit of animation to the sound by routing the LFO to control the filter. For this effect, set the LFO “amount” low for a subtle effect.

When a PatchCord amount is a negative value, the LFO shape is inverted. For example, inverting the sawtooth wave produces a wave that increases abruptly, then smoothly glides down.

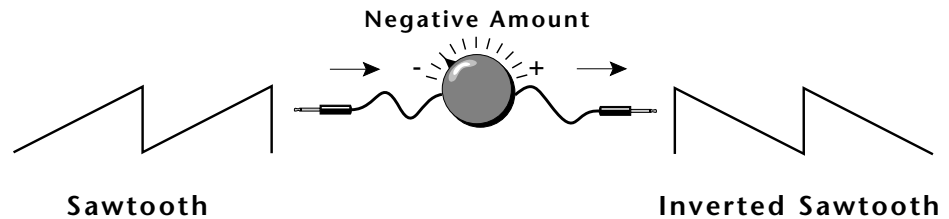

Clock Modulation

 Envelopes are triggered on the positive going edge of the clock. LFOs are triggered on the negative going edge of the clock.

 The tempo of the master clock is set in the Arp/Beats menu.

You can use the Master Clock as a modulation source, to trigger the Filter or Auxiliary Envelope generators, trigger Sample Start, synchronize the LFOs, or directly as a square wave modulation source. The Clock source is available in eight divisions (octal whole note, quad whole note, double whole note, whole note, half note, quarter note, eighth note, sixteenth note). You can use the different rates separately or in conjunction to create complex “synchro-sonic” rhythm patterns. You can also use a MIDI Clock as the Master Clock to synchronize to an external MIDI device such as a drum machine or sequencer. (See “Base Tempo (Master Clock)” on page 36.)

Clocks are routed exactly like the other modulations sources using the PatchCords. The PatchCord Amount MUST be positive (+) for the clock to pass. By modulating the PatchCord Amount, you can route the divided clocks using real-time controllers or other modulation sources.

When an LFO is triggered by a clock, the LFO wave resets to zero every time the clock wave goes low. If the LFO rate is close to the clock rate, the LFO virtually synchronizes with the clock. If the two rates are far apart, the waveform of the LFO will be mildly or radically altered.

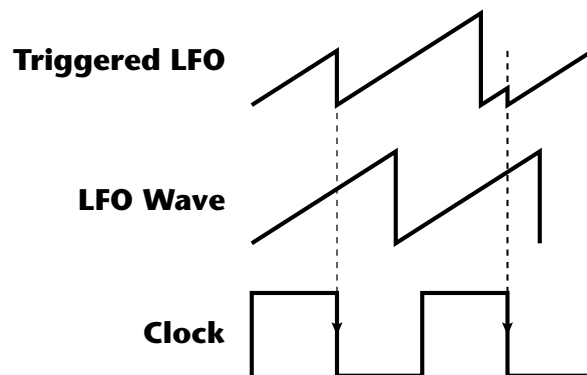

LFO Trigger causes the LFO to reset each time the clock waveform goes low.



LFO Synced to 1/4 Note Clock

LFOs can also be perfectly synchronized with the clock at any of 25 note divisions. This allows you to create very cool “synchro-sonic” effects that work perfectly at any tempo. Choosing one of the note divisors in the LFO rate screen selects the synced LFO function.

There are many possibilities for clock modulation and retrigger. For example, you can create a repeating six segment curve of any shape by triggering the Filter or Auxiliary Envelope generators with the clock. A few other possibilities are listed below.

- Turn different voice layers on and off using different clock divisors.
- Switch between Auxiliary and Filter Envelope retriggering using a slider or footswitch.
- Retrigger LFOs or Envelopes using noise or other LFOs to create random or semi random effects.
- Alter the LFO waveform by modulating the rate of a triggered LFO.
- Route multiple clocks with different divisors to the same destination (such as pitch) to create complex patterns. (*Hint: Adjust the PatchCord Amounts.*)

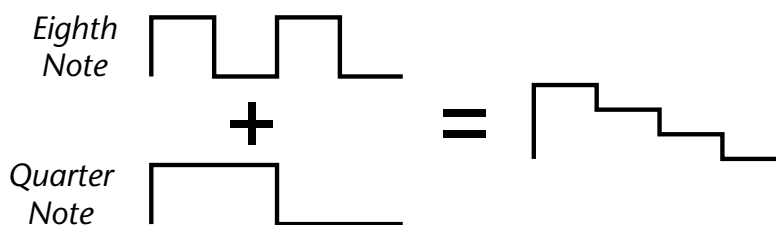

Adding these two clocks together in equal amounts produces a stairstep waveform.

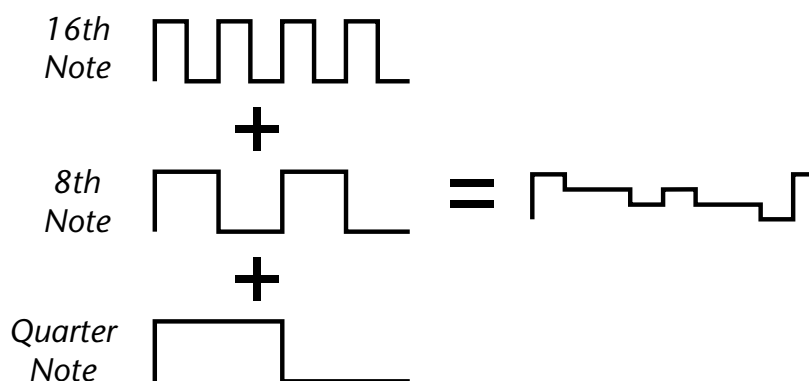

Adding multiple clocks with unequal amounts produces complex repeating patterns.

Modulation Destinations

The PatchCords section of the Edit menu is where you connect sources to destinations. Each PatchCord has an amount associated with it which controls how much modulation is applied.

L1	PATCHCORD	#01
	ModWhl ->	RTXfade +036

The PatchCords screen above and the diagram below show how modulation sources are connected to destinations. The modulation sources can control any of the destinations in the layer.

 All the modulation destinations are summing nodes. This means that you can connect as many modulation sources as you want to a destination. Modulation sources are simply added algebraically — connecting two sources, one with a value of -100 and the other with a value of +100 yields a net value of zero.

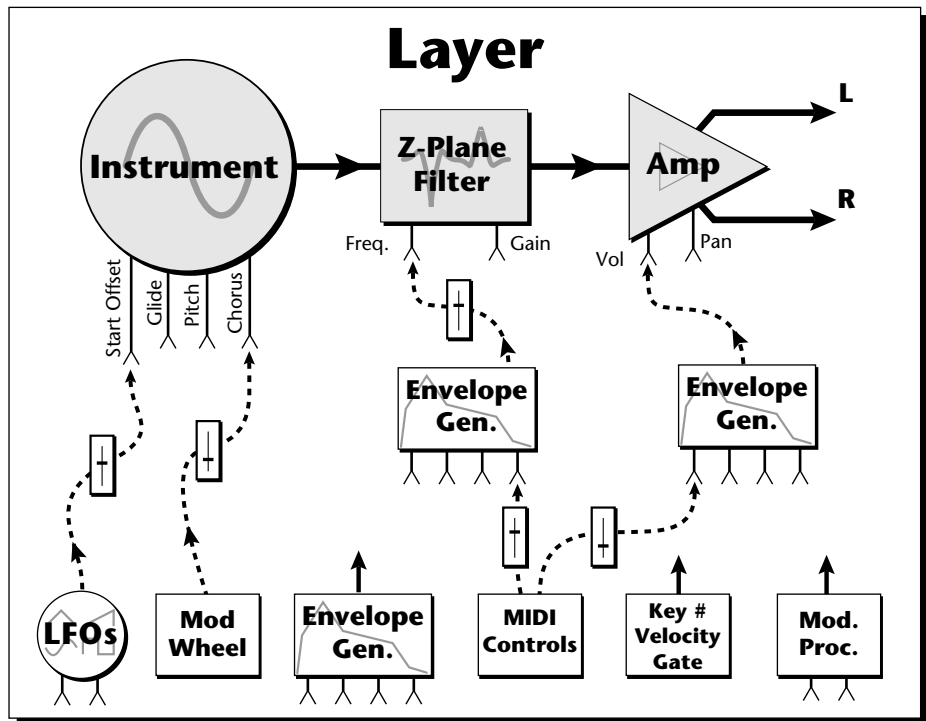

- Note-on modulation sources, such as key, velocity and gate output a single value at note-on time. Realtime modulation sources such as LFOs, envelope generators and modulation wheels output continuously changing values.

The possible modulation routings are completely flexible as shown in the diagram above. Multiple sources can control the same destination, or a single source can control multiple destinations.

Modulation Processors

Modulation processors are devices which can modify modulation sources such as LFOs and envelope generators before they are applied to a destination. Modulation processors let you create patches and do tricks which would not be possible otherwise. These modulation processors are independently programmable on each of the four layers.

Switch

Outputs a digital “1” when the input is greater than “0”.

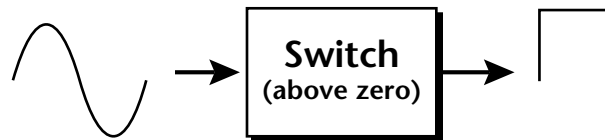

Summing Amp

Lets you add several modulation signals together before applying them to a destination. This processor can save PatchCords when routing the output to multiple destinations.

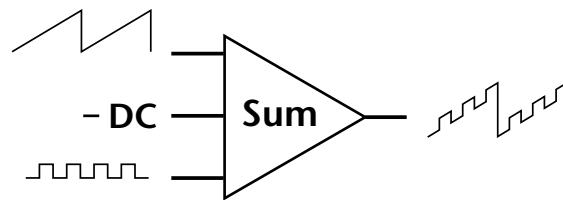

Lag Processors

Slows down rapid changes in the input signal. The output “lags” behind the input at a pre-programmed rate. There are two lag processors, Lag 0 and Lag 1. Lag 1 has a longer lag time than Lag 0.

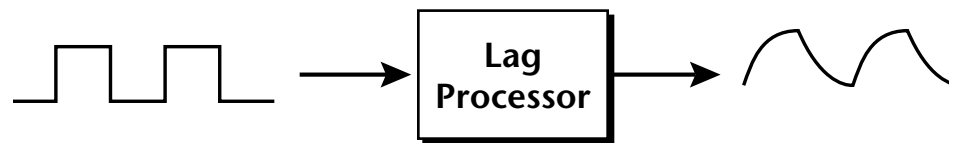

Absolute Value

This function inverts negative input values and outputs only positive values. This device is also called a full wave rectifier.

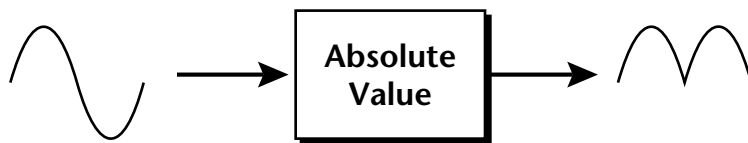

Diode

The diode blocks negative input values, passing only positive values.

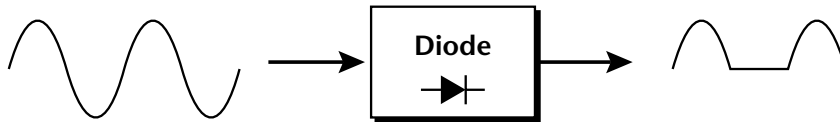

Flip-Flop

The output of this processor alternates between a digital "1" and digital "0" each time the input goes positive from zero or a negative value. With an LFO input, the output will be a square wave of half the input frequency.



 The value of a digital "1" is equal to the PatchCord amount.

Quantizer

With the input PatchCord set to 100%, the output value is limited to 16 discrete values. The value of the input PatchCord controls the number of steps. The value of the output PatchCord controls the size of the steps.

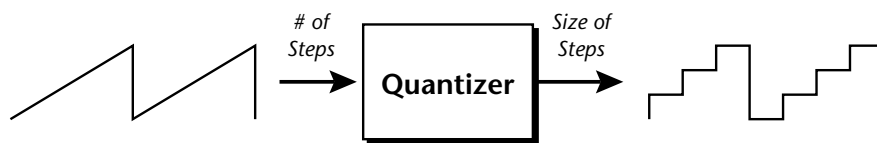

4x Gain

This processor amplifies the modulation source by a factor of 4.

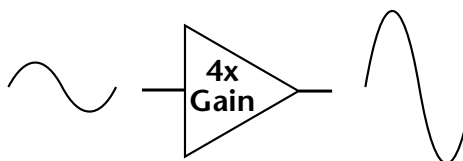

 Summing Amps can be useful in complicated patches where you want to control a combination of modulation signals with a single patchcord.

Lag Inputs

The Lag processors can be used as 2 additional summing amps. Lag0sum and Lag1sum are modulation sources which equal the sum of PatchCords connected to the Lag in destination. The summing amp is located before the lag processor as shown in the following illustration.

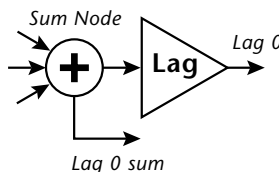

Preset Modulation Processors



Preset Modulation Processors start working as soon as the preset is selected. The Layer Modulation Processors take effect only when a key is pressed.

There are also two “Preset Level” modulation processors located in the “Preset Patchcords” screen of the Edit menu. It is important to understand that although the preset processors *originate* at the *Preset Level PatchCords*, their output is used in the *Layer PatchCords*.

Preset Lag

Like the Layer Lag processors (*described on page 93*) the Preset Lag slows down rapid changes in the input signal. The output “lags” behind the input at a pre-programmed rate. Unlike the layer level lag processors, the *preset lag* takes effect as soon as the preset is selected. In contrast, the layer level lag processors begin acting only after a keyboard key has been depressed. The Preset Lag also has a *Lag Amount* input which controls the lag time. Positive lag amounts increase the lag time. A MIDI controller (*front panel knob*) is commonly used to control lag amount.

The preset lag can be used to “spin-up” and “spin-down” an LFO which controls some other effect, perhaps left/right panning, pitch, or the filter. A MIDI footswitch could be used as the input to the lag which acts to slow down the instantaneous change of the switch. The slowly changing output value is then routed using a layer patchcord to crossfade between layers or change the speed of an LFO.

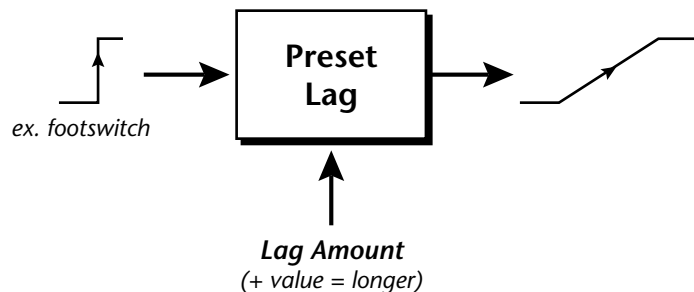

Preset Ramp

This processor generates a positive or negative going slope whenever the **first** key is depressed on the MIDI channel.

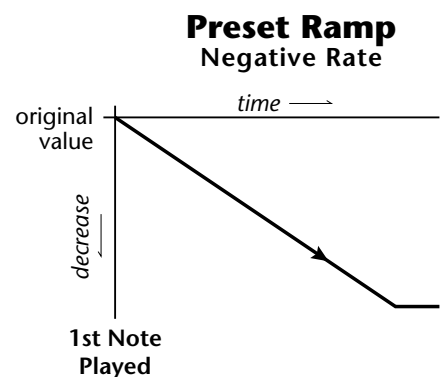
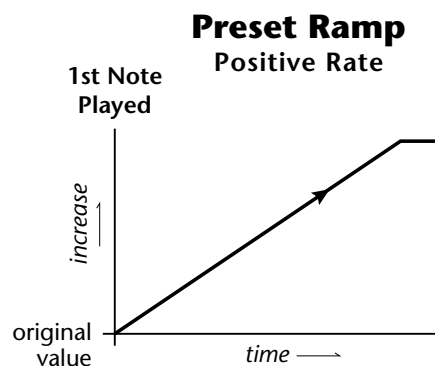

The preset ramp instantly resets when all notes have been released and the next *first key* on the MIDI channel is pressed. The Ramp Rate polarity (+ or -) determines if the ramp will be positive or negative going. The value of the ramp rate sets the increment. Large values produce fast ramps and small values produce slow ramps. Multiple inputs can be connected to the ramp rate (just like all the other destinations in Mo'Phatt).

The patch below shows an application for the Preset Ramp which generates an adjustable decay envelope ONLY on the first note played to bring in the sound from another layer. Instead of routing the output to the Amp Volume you could just as easily route it to control Pitch, LFO Speed or any other destination you can think of. Study this patch if you want to learn a few new tricks using the patchcords.

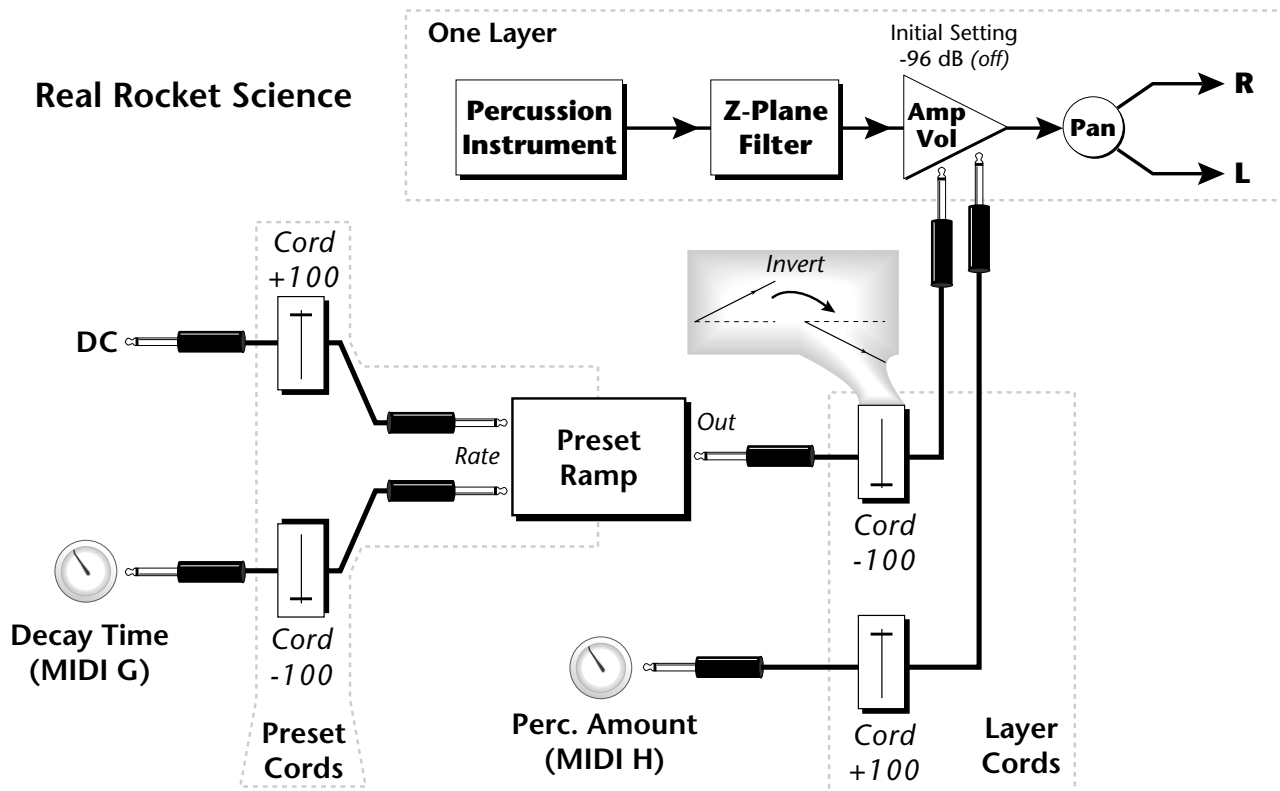

1. DC - Sets initial ramp Fast-Positive (+100)
2. Decay Knob - Inverted value slows ramp as the knob value is increased.
3. Ramp Out Cord - Inverts Ramp slope (downward).
4. Amp Vol - Initial setting is Off (-96dB). Ramp cannot overcome this negative bias.
5. Perc. Amt - When this knob is turned up, the positive bias on the Amp is restored so that so that the Ramp can now affect Amp Volume.
6. Volume Envelope - Fast Attack, Full Sustain, No Release

 The combination of the DC & Perc. Decay Time Cords has the effect of reversing the Percussion Decay Time knob. The decay time increases as the knob is turned up.

Using the Modulation Processors

Modulation processors are inserted into a modulation routing as shown in the following diagram.

The modular analog synthesizers of yesteryear were incredibly flexible, partly because processing devices could be connected in any order. Modulation processors are designed according to this modular concept. They can be linked and used in a wide variety of ways limited only by your imagination. Consider the following example:

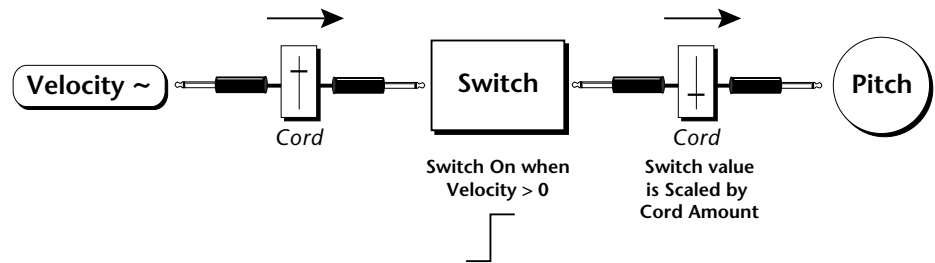

The patch illustrated above is programmed by setting the PatchCord screens as shown below.



This particular modulation shifts the overall pitch up a fifth when the key velocity exceeds 64. Velocities below 64 play at normal pitch. Notes with velocities of 64 and above are raised a perfect fifth. The Velocity “~” source scales the played velocity around zero. In other words, low velocities (below 64) will have negative values and high velocities (64 and above) will be positive. A velocity of 64 would be zero. The Switch module only outputs a “1” if the input value is greater than zero. This digital “1” value can be scaled through the attenuator on the PatchCord to raise or lower the pitch by any amount. In this case, a scaling value of +22 raises the pitch by a perfect fifth. The amount of the PatchCord on the input to the switch is unimportant because ANY velocity value equal or greater than 64 will flip the switch. If the input PatchCord amount were a negative value however, the action of the velocity would be reversed and velocities less than 64 would raise the pitch and velocities equal or greater than 64 would play the original pitch.

But what if you want the velocity switch point to be something other than 64? Thanks to modulation processors, it can be done. Here's how.

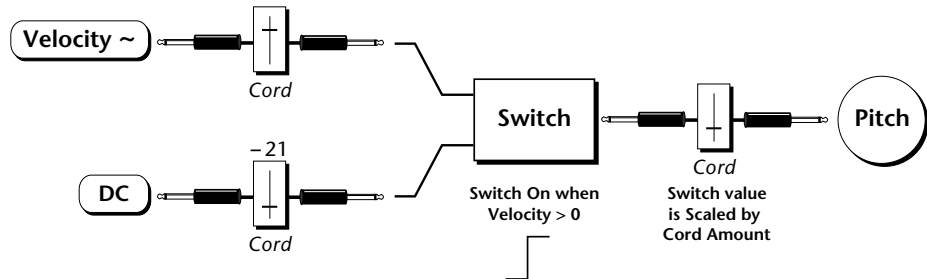

Connect the DC level to the input of the switch along with the velocity value. Note that more than one modulation source can be applied to the input of a processor.

DC offset adds a fixed value based on the PatchCord Amount setting. If applied to the switch along with the velocity, it changes the velocity value required to trip the switch. By setting the DC amount to a negative amount, higher velocity values are required to trip the switch. Setting the DC value to a positive value would bring the velocity switch point down. The PatchCord screens for this patch are shown below.

L1 PATCHCORD	#01
Vel+- -> Switch	+100

L1 PATCHCORD	#02
DC -> Switch	-021

L1 PATCHCORD	#03
Switch -> Pitch	+022

More Examples

To derive a smooth random function you could route the Pink Noise generator through one of the Lag Processors. A smooth random wave is useful in small amounts to add a degree of natural variation to timbre when routed to filter cutoff. Normal pink noise is low pass filtered audio frequency noise with a 3 dB/octave slope to give equal energy per octave. Mo'Phatt pink noise is actually more like very low frequency filtered noise, but it is perfect for use as a random control source.

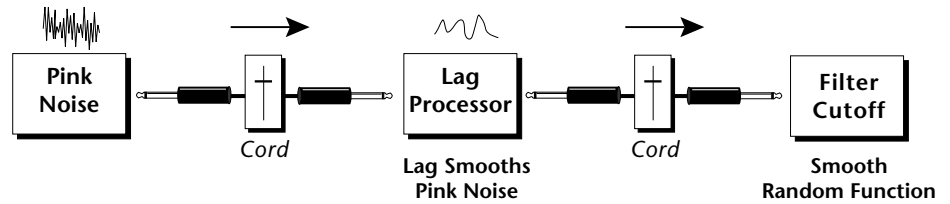

The **Quantizer** can generate interesting whole-tone scales when envelope generators or LFOs are routed to the input. The quantizer turns a smoothly changing input signal into a series of steps. By routing the output of the quantizer to Pitch and adjusting the PatchCord amounts, you can control both the number of steps and the pitch interval of each step.

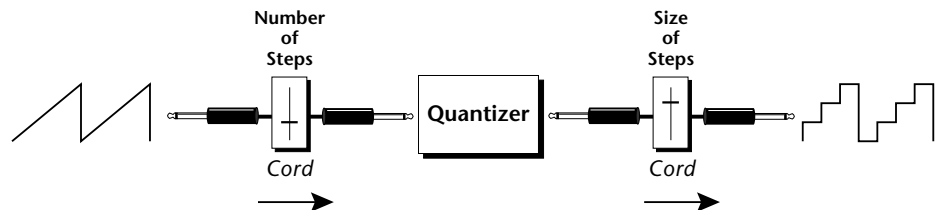

The input PatchCord amount controls how many steps will be generated. With a sawtooth wave (LFO+) feeding the input and the PatchCord amount set to 100%, sixteen steps are generated. The output PatchCord amount controls the size (or interval) of the steps.

Try setting up the following patch exactly as shown below using your favorite preset as a starting point.

L1	LFO1	SHAPE	SYNC
		sawtooth	key sync

L1	LFO1	RATE	DELAY	VAR
		0.35Hz	000	000

 The 4x Amp can be used to get more steps or increase the interval of the Quantizer.

L1	PATCHCORD	#01
LFO1+	-> Quantize	+030

L1	PATCHCORD	#02
Quantize	-> Pitch	+100

L1	PATCHCORD	#03
DC	-> Pitch	-050

 Experiment with this patch by connecting other sources and destinations to the Quantizer.

This patch generates an ascending arpeggio every time a key is pressed. A diagram of the patch is shown below. The patch is very straightforward except for the DC offset which was added to bring the pitch down into tune. (Sometimes you have to fix a problem, but using the mod processors there's usually a way around it to achieve the desired result.)

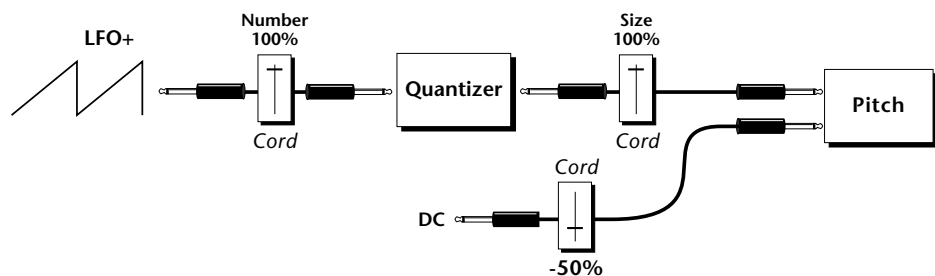

You can start to see some of the possibilities (and there are many). Whenever you find yourself wishing for some esoteric type of control, take a minute to think and see if there is a way to achieve the desired result using the modulation processors.

Dynamic Filters

The block diagram of the Mo'Phatt's signal path is shown below.

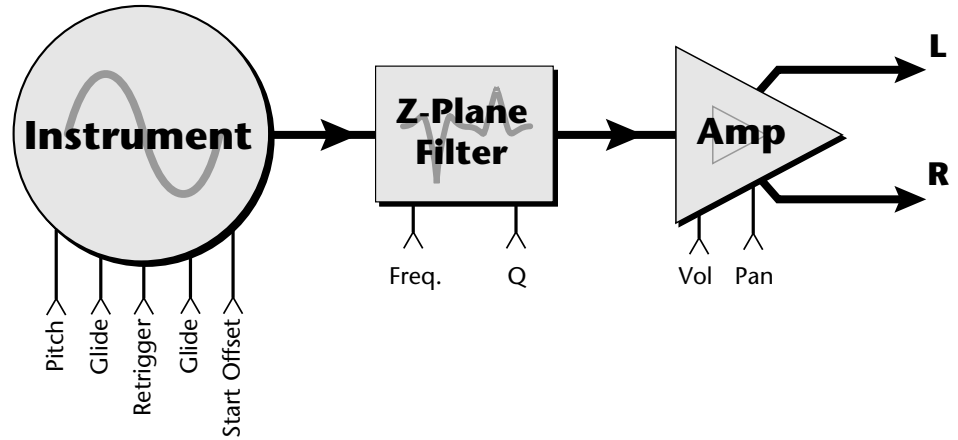

To understand how a filter works, we need to understand what makes up a sound wave. A sine wave is the simplest form of sound wave. Any waveform, except a sine wave, can be analyzed as a mix of sine waves at specific frequencies and amplitudes.

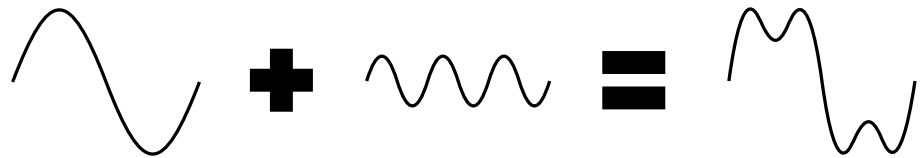

Any waveform can be analyzed as a mixture of sine waves.

One way to represent complex waveforms is to use a chart with frequency on one axis and amplitude on the other. Each vertical line of the chart represents one sine wave at a specific amplitude and frequency.

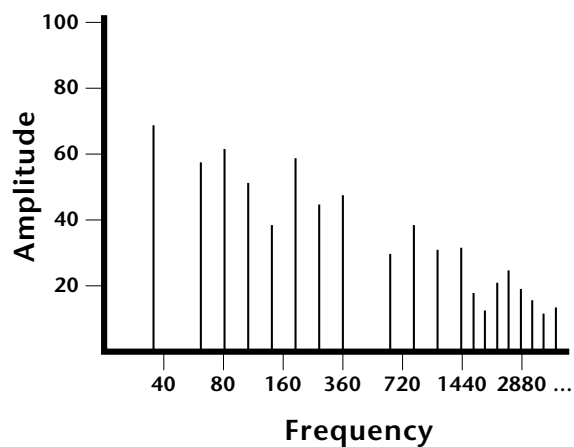

What is a Filter?

Most sounds are complex waves containing many sine waves of various amplitudes and frequencies. A **filter** is a device which allows us to **remove certain components of a sound depending on its frequency**. For example, a *low-pass filter* lets the low frequencies pass and removes only the high frequencies as illustrated in the following diagram.

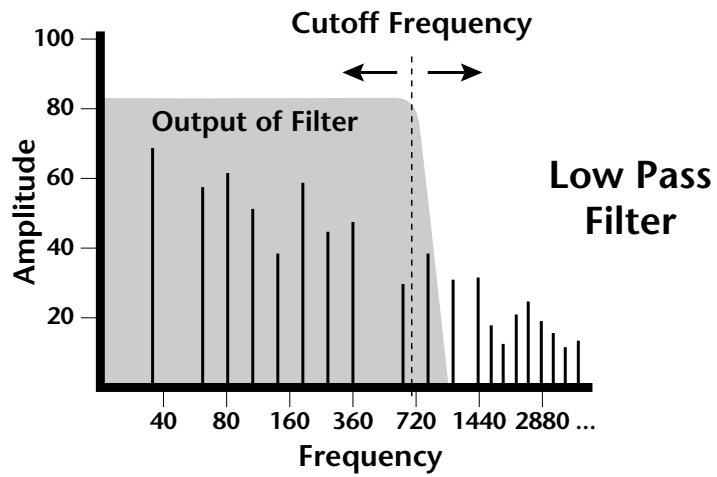

A filter that lets only the high frequencies pass is called a *high-pass filter* as illustrated in the following diagram.

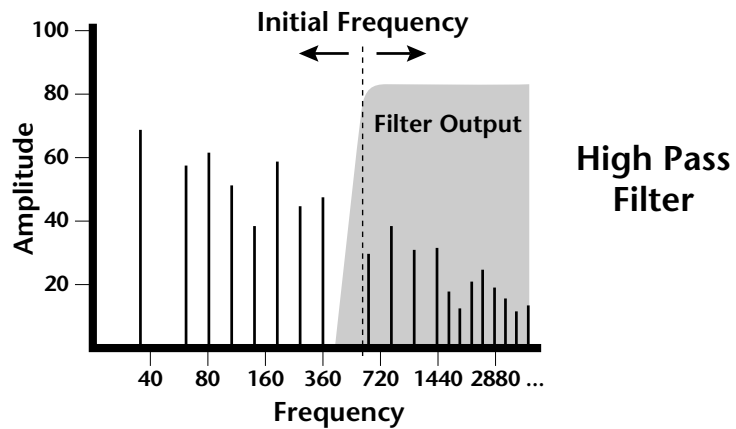

A filter which only lets a certain band of frequencies pass is called a *band-pass filter*.

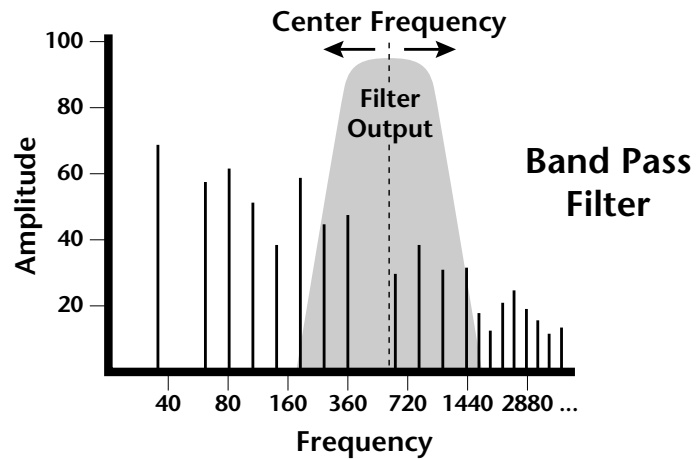

A *notch filter* is just the opposite of a band-pass filter and is used to eliminate a narrow band of frequencies.

Another control found on traditional filters is called Q or resonance. A lowpass filter with a high Q emphasizes the frequencies around the cutoff frequency. The following chart shows how different amounts of Q affect the low-pass filter response. In terms of sound, frequencies around the cutoff tend to “ring” with high Q settings. If a filter with high Q is slowly swept back and forth, various overtones are “picked out” of the sound and amplified as the resonant peak sweeps over them. Bells and gongs are real world examples of sounds which have a high Q.

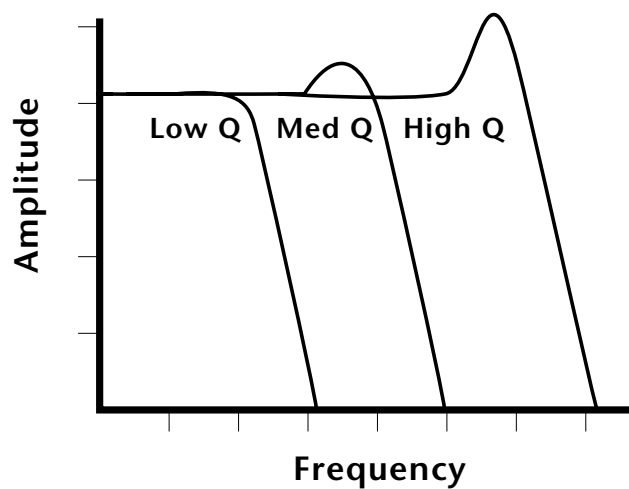

Another characteristic of a filter is the number of poles it contains. Traditional synthesizer filters were usually either 2-pole or 4-pole filters. The Mo'Phatt has selectable 2, 4, and 6-pole low-pass filters. The number of poles in a filter describes the steepness of its slope. The more poles, the steeper the filter's slope and the stronger the filtering action. The tone controls on your home stereo are probably one-pole or two-pole filters. Parametric equalizers are usually either two-pole or three-pole filters.

In terms of vintage synthesizers, Moog and ARP synthesizers used 4-pole filters, Oberheim and E-MU synthesizers were famous for their 2-pole filter sound.

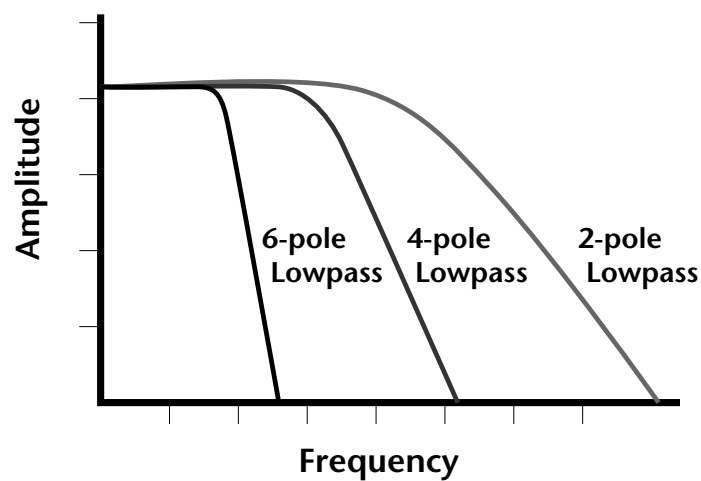

Using a filter, we have a way to control the harmonic content of a sound. As it turns out, even a simple low-pass filter can simulate the response of many natural sounds.

For example, when a piano string is struck by its hammer, there are initially a lot of high frequencies present. If the same note is played softer, there are fewer high frequencies generated by the string. We can simulate this effect by routing keyboard velocity to control the low-pass filter. The result is expressive, natural control over the sound.

If you use an envelope generator to control the cutoff frequency of a filter, the frequency content can be varied dynamically over the course of the note. This adds animation to the sound as well as simulates the response of many natural instruments.

Parametric Filters

A more complex type of filter is called a parametric filter or *Swept EQ*. A parametric filter allows control over three basic parameters of the filter. The three parameters are: *Bandwidth*, *Frequency* and *Gain*. The Bandwidth allows you to select the width of the range of frequencies to be boosted or cut, the Frequency defines the center frequency of the bandwidth, and the Gain parameter either boosts or cuts the frequencies within the selected band by a specified amount. Frequencies not included in the selected band are left unaltered. This is different from a band-pass filter which attenuates (reduces) frequencies outside the selected band.

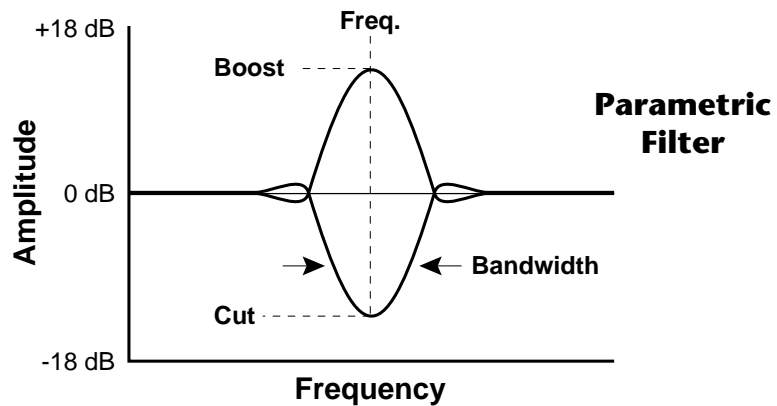

The parametric filter is quite flexible. Any range of frequencies can be either amplified or attenuated. Several parametric sections are often cascaded in order to create complex filter response curves.

If four parametric filter sections were cascaded, it would be possible to create the following complex filter response.

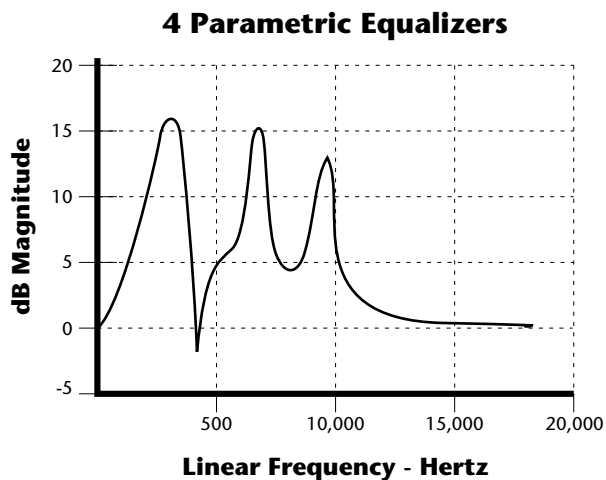

Many natural instruments have complex resonances which are based on their soundboard or tube size. The resonance shown above would be impossible to create using a normal synthesizer filter.

The Z-Plane Filter

A Z-plane filter is a filter which can change its function over time. In a Z-plane filter, we start with two complex filter types and interpolate between them using a single parameter. See the following diagram.

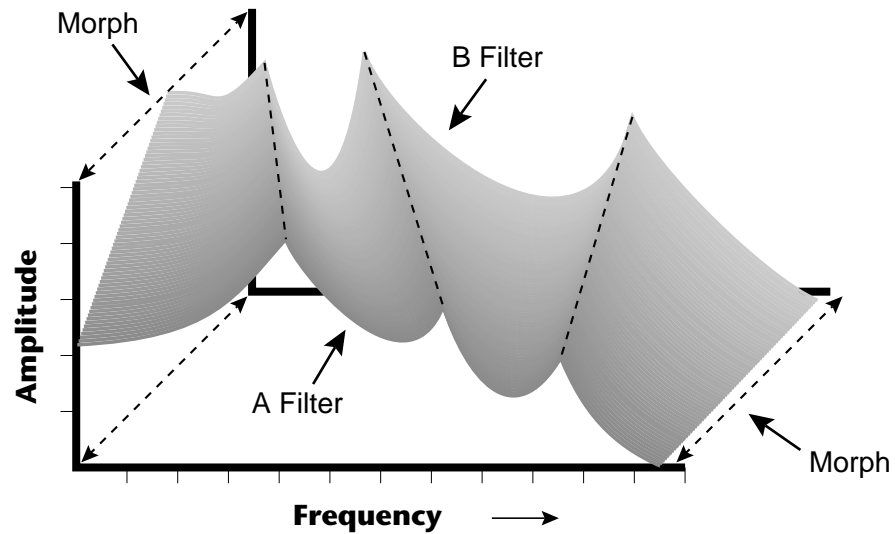

The Z-plane filter has the unique ability to change its function over time.

Filters A and B represent two different complex filters or “frames.” Changing a single parameter, the Morph, changes many complex filter parameters simultaneously. Following along the Morph axis you can see that the filter response smoothly interpolates between the two filters. This is the essence of the Z-plane filter. Through the use of interpolation, many complex parameters are condensed into one manageable entity.

Consider, as an example, the human vocal tract, which is a type of complex filter or resonator. There are dozens of different muscles controlling the shape of the vocal tract. When speaking, however, we don't think of the muscles, we just remember how it feels to form the vowels. A vowel is really a configuration of many muscles, but we consider it a single object. In changing from one vowel to another, we don't need to consider the frequencies of the resonant peaks. You remember the shape of your mouth for each sound and interpolate between them.

This Z-plane filter sweep can be controlled by an envelope generator, an LFO, modulation wheels or pedals, keyboard velocity, key pressure, and so on. In fact, any of the modulation sources can control the Z-plane filter.

Because creating the complex filtering is difficult and very time consuming, we have created 50 different filters and installed them permanently in ROM for your use. You simply select and use the filters in a manner similar to choosing an instrument. Because there are so many types of instruments and filters to choose from, the number of possible permutations is staggering.

Signal Flow

Going back to the Signal Path diagram for a single channel we can reexamine the complete signal path.

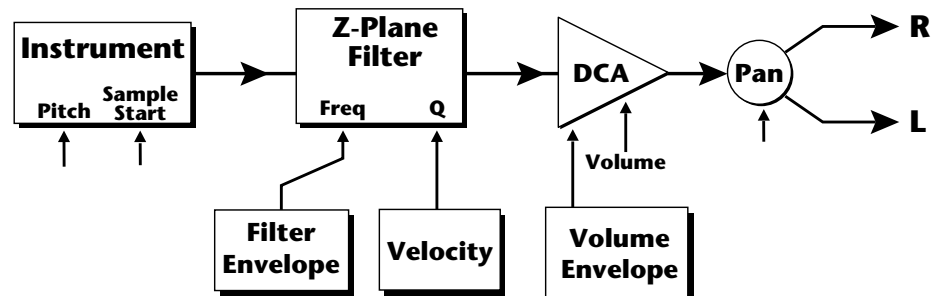

Instrument

This is the sampled sound wave. The pitch of the instrument can be modulated by any modulation source. The sample start point can be changed only at the time the note is played.

Z-Plane Filter

The Z-Plane Filter is used to shape the harmonic content of an instrument. The filter envelope is commonly used to shape the harmonic content dynamically over time but the filter frequency can be modulated by any source. The Q parameter can be modulated only at note-on time. There are 50 types of filters available. See “Mo’Phatt Filter Types” on page 133 for a complete list of the filters.

Digitally Controlled Amplifier (DCA)

Together with the Volume Envelope, the DCA is used to shape the volume contour of a sound. The DCA can be controlled by any modulation source. Velocity is often used as a modulation source for the DCA so that the harder you play, the louder the sound becomes.

Pan

Adjusts the balance of sound to the left and right channels. Pan can be modulated by any modulation source.

MIDI Channels & Real-time Controls

The MIDI real-time controllers may seem confusing at first, but they are really very simple once you understand them. You already know that there are 16 MIDI channels per MIDI cable. Each MIDI channel uses three basic types of messages; note on/off, preset changes, and continuous controller messages. Your MIDI keyboard, in addition to telling Mo'Phatt which note was played, can also send real-time control information, which simply means control occurring in real-time or "live." (You may be using a MIDI device other than a keyboard, but for simplicity's sake we'll presume that you are using a keyboard.) Real-time control sources include such things as pitch wheels or levers, modulation wheels or levers, control pedals and aftertouch and are used to add more expression or control.

Your MIDI keyboard sends out real-time controller information on separate continuous controller numbers. There is a set of 32 continuous controller numbers for each MIDI channel. Some of the controllers, such as the modulation wheel, volume, and pan have standardized numbers. For example, volume is usually sent on continuous controller #7. Your keyboard may have other real-time controls such as a control pedal or data sliders which can also be programmed to control the Mo'Phatt.



The following MIDI controls are automatically routed in Mo'Phatt:

Pitch Wheel	pwh
Modulation Wheel	01
Old DX7 Aftertouch	03
Pedal	04
Volume	07
Pan	10
Expression	11

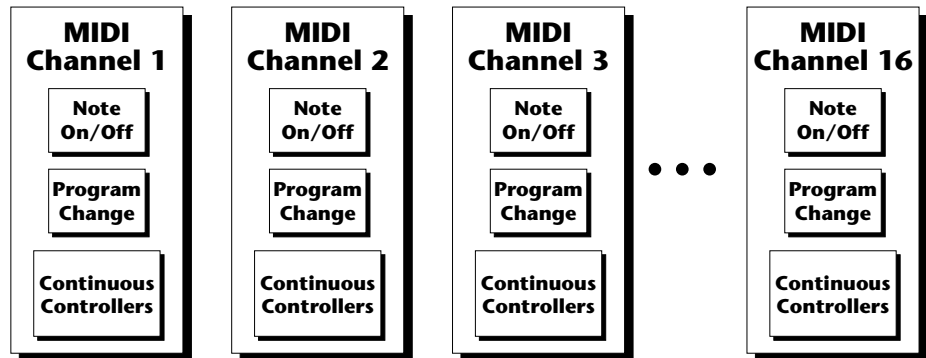

Any MIDI controller can be routed to any modulation destination. First, you have to know which controller numbers your keyboard transmits. Most modern MIDI keyboards let you select a controller number for each control on the keyboard. For example, it may let you select a number from 0-31 for the data slider. The realtime controller numbers that the keyboard transmits must match the numbers Mo'Phatt is receiving, otherwise nothing will happen when you move the controls.

Suppose you wanted to send the four data sliders on your master keyboard. Mo'Phatt can handle 12 MIDI controllers (A-L) of your choosing. "MIDI A-L" are simply names for the internal connections that link external MIDI continuous controllers to the PatchCord section of Mo'Phatt. There are two parts to the connection. First, MIDI controller numbers are assigned to the letters A-L in the Master menu. Next, the letters A-L are connected to synthesizer control parameters in the PatchCord section of the Edit menu. The PatchCord Amount scales the amount of each controller by a positive or negative value.

The factory presets have the MIDI A-L controls connected to standard synthesizer functions (marked on the front panel). By choosing any four of the 12 standard functions, the four sliders on your keyboard will work the same on every preset. The chart below shows how this might work if your keyboard transmitted the slider settings on MIDI controllers 21-24.

Control	MIDI Controller #	Routing	Standard Function
Slider 1	21	A	Controls Filter Frequency
Slider 2	22	B	Controls Filter Resonance
Slider 3	23	C	Controls Envelope Attack
Slider 4	24	D	Controls Envelope Release

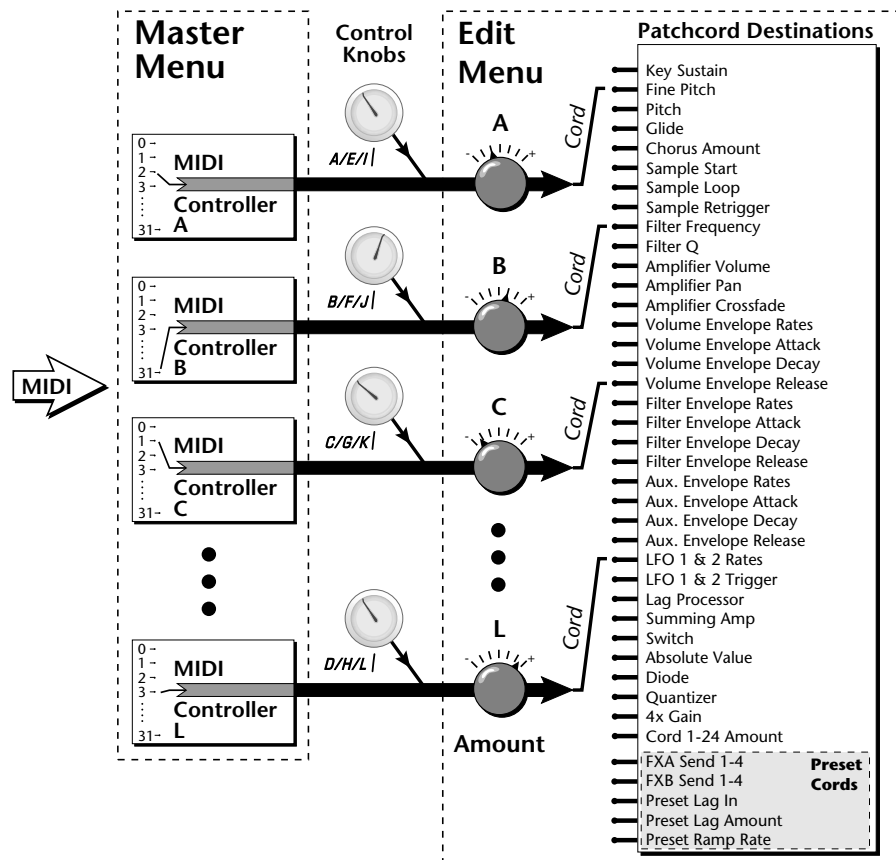

MIDI A-L are internal connections which simultaneously carry front panel controller knob data and MIDI continuous controller data.

The four controller knobs on the Mo'Phatt front panel work just like MIDI real-time controllers. The four controller knobs are permanently assigned to controllers A-L. Pressing the control button adjacent to the row of knobs selects A-D, E-H or I-L functions for the knobs. The front panel knob (A-L) and incoming MIDI controller messages assigned to that letter, both control the same parameter that you select in the PatchCord screen.

Bank Select Commands

 When you press the Audition button, the Bank Select MSB and LSB are displayed on the top line of the display.

When the original MIDI specification was developed, synthesizers had only 8 to 40 preset locations. At that time being able to select up to 128 presets didn't seem like much of a limitation. So it was that the original MIDI specification provided for the selection of up to 128 presets.

Musicians screamed for *MORE* and so the MIDI specification was later amended to include **Bank Select Commands**. It was decided that Bank Select Commands would use Continuous Controllers 0 and 32 to allow the selection of up to 16,384 banks of 128 presets (over two million presets).

Because Bank Selects are implemented using Continuous Controllers, the Bank Selections can be made *per channel*. (This is getting better and better.) For each MIDI channel, you can select any of 16,384 banks and then one of the 128 presets in the bank. Of course no synthesizer has 16,384 banks (yet), but hey, it's nice to know it's possible (for that really BIG project).

Continuous Controller (CC) 0 is the MSB (most significant byte) and CC 32 is the LSB (least significant byte). Normally you send both the MSB and LSB controllers to implement a bank change.

Mo'Phatt remembers the MSB and the LSB that were last sent (or last changed from the front panel). For example, if you have already set the Bank MSB to 04, you need only send the LSB to change banks within the Mo'Phatt sound set. See the MIDI Bank Select chart below.

The selected bank remains selected until you change it (either via MIDI or by changing the bank from the front panel). Standard MIDI Program Change commands select from 128 presets within the selected bank.

MIDI BANK SELECT			
	MSB	LSB	
	cc00	cc32	
USER	00	00	Bank 0
USER	00	01	Bank 1
USER	00	02	Bank 2
USER	00	03	Bank 3
PHATT	13	00	Bank 0
PHATT	13	01	Bank 1
PHATT	13	02	Bank 2
PHATT	13	03	Bank 3

Stereo Mix Outputs

This feature is useful for adding signal processing (EQ, reverb, etc.) of individual sounds prior to final mixdown.

The routing can be performed according to MIDI channel from the Mix Output screen in the Master menu. Simply assign each channel to the desired output.

**Master
Menu**

MIX OUTPUT
channel 01: Send 2

To route a particular preset to a Send, first go to the Mix Output screen in the Master menu and set the MIDI channel to "Preset".

**Master
Menu**

MIX OUTPUT
channel 01: Preset

Next set the Mix Output routing in the preset to the desired output (for each layer). Yes, you can send each layer to a different send if you want.

**Edit
Menu**

L1 MIX OUTPUT
Send 2

By sending different amounts of presets to the effects, subtle or striking effects can be achieved using the two effect processors. This feature allows you to get the most out of two effects since you can have eight different mixes.

For more information, refer to the diagram on the following page or, See "Mix Output" on page 67.

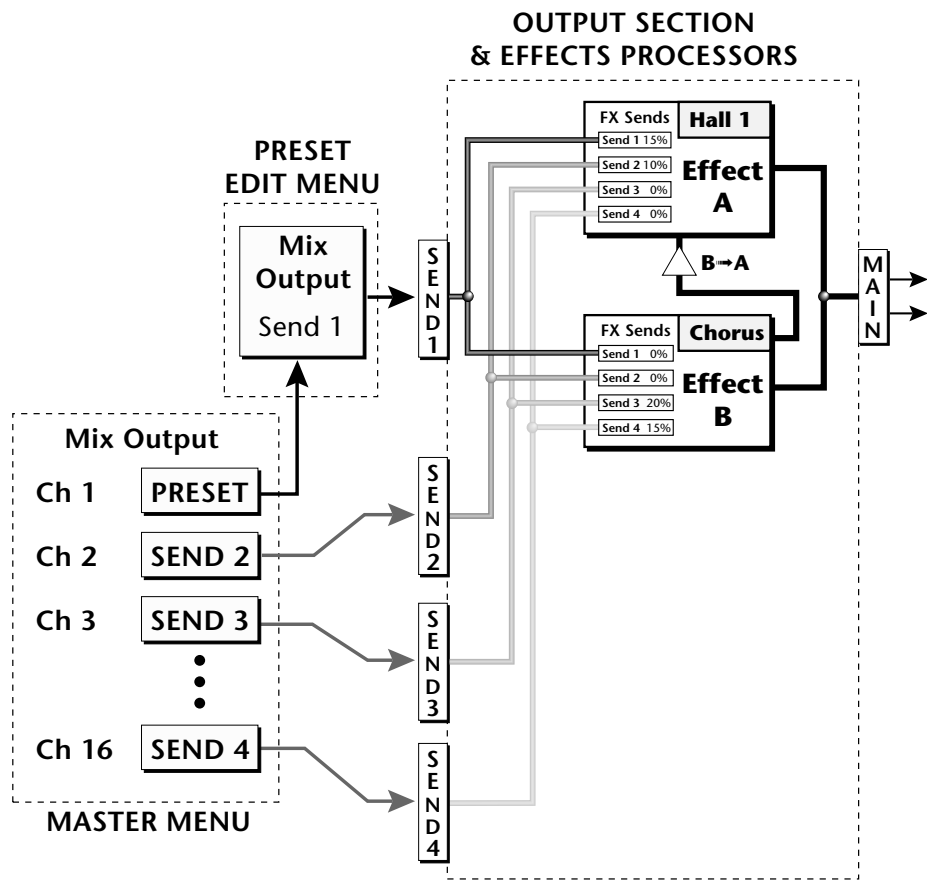

The Mix Output screen in the **Master** menu assigns each MIDI channel to a Send (1-4) or to "Preset".

The Mix Output screen in the **Edit** menu is **ONLY** used if the Master Mix Output is set to "Preset". Otherwise the Edit menu Mix Output settings are ignored.

Edit Menu



While the Edit menu is activated, all incoming MIDI preset changes on the selected channel are ignored.



If there is no "A" option in the Layer field, you must enable the "Edit All Layers" function in the Master Menu.

The Edit Menu contains four layers of preset parameters that you can modify and then save as preset information in one of the user preset locations.

There are four instrument layers in the Edit menu. See the illustration on page 115 for a description of the Preset Layer model.

► To Access the Edit Menu

Press the Edit button, lighting the LED. The Edit Menu screen displays the menu page most recently selected since powering up Mo'Phatt. The cursor appears below the first character of the screen heading on line one.

► To Scroll through Layers

Place the cursor below the layer field. Rotate the Data Entry Control to select a layer (1-4).

You can also select **All Layers** by choosing "A" in the layer field. When All Layers is selected, the existing parameter value for any field will be displayed if the values of all four layers are equal. If the values of all four layers are NOT equal, the value of layer 1 will be displayed with flashing characters. If you change the parameter value, all layers will assume the new value and the display will stop flashing.

► To Scroll through Pages

Place the cursor below the page title field. This will automatically be done when you press the Home/Enter button. Rotate the Data Entry Control to scroll through the pages.

► To Change a Parameter

Place the cursor below the parameter field. Rotate the Data Entry Control to change the parameter value.

Preset Name

The Preset names consists of two parts: a 3 letter preset category and a 12 letter preset name. Position the cursor under the character location and use the data entry control to change the character.

The preset category is used in conjunction with the Sound Navigator feature. Using the Sound Navigator, a category is selected and the presets in that category are listed in alphabetical order. Creating categories makes it easier to find specific sounds when you need them. For more information on Sound Navigator, see Sound Navigator in Chapter 2: Operations.



The keyboard can also be used to select character. The charts below show the keyboard character assignments.

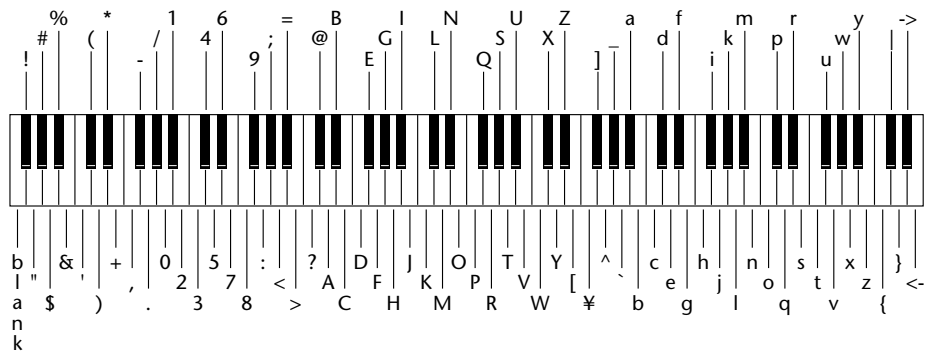

	C	C#	D	D#	E	F	F#	G	G#	A	A#	B	Pitch
-2						blank	!	"	#	\$	%	&	
-1	'	()	*	+	,	-	.	/	0	1	2		
0	3	4	5	6	7	8	9	:	;	<	=	>	
1	?	@	A	B	C	D	E	F	G	H	I	J	
2	K	L	M	N	O	P	Q	R	S	T	U	V	
3	W	X	Y	Z	[¥]	^	_	`	a	b	
4	c	d	e	f	g	h	i	j	k	l	m	n	
5	o	p	q	r	s	t	u	v	w	x	y	z	
6	{		}	→	←								

Octave

Four Layer Architecture

Mo'Phatt provides a 4 layer instrument structure. Each layer is a complete synthesizer voice with 50 filter types, over 64 modulation sources, more than 64 modulation destinations and 24 patchcords to connect everything together. In addition, the four layers can be crossfaded or switched by key position, velocity or any real-time modulation source.

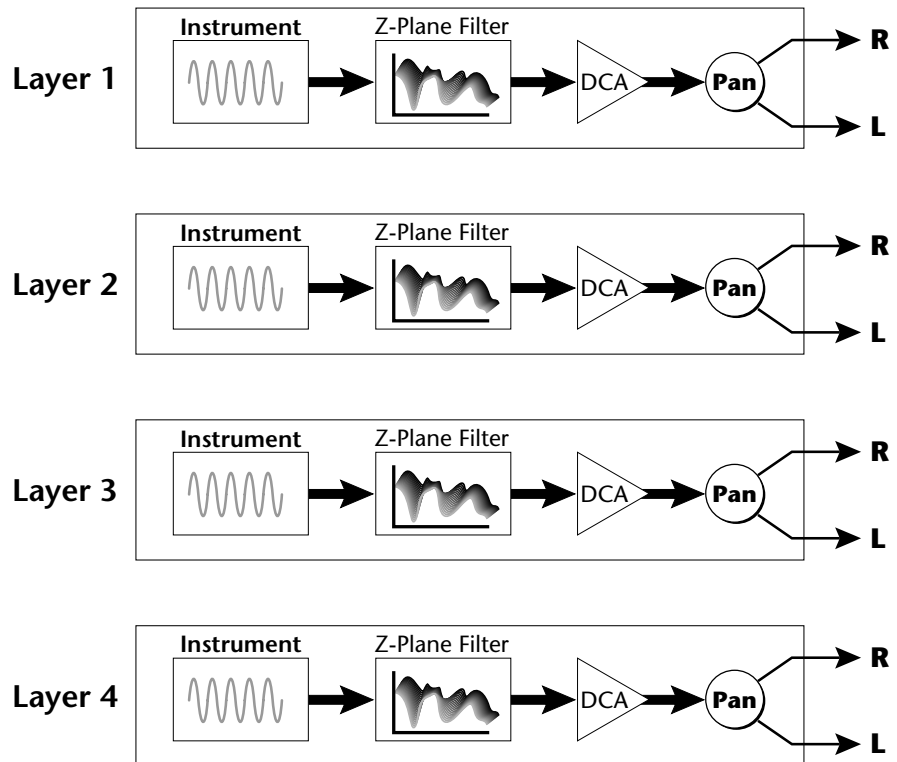

Selecting Layers

In most of the Edit screens, the selected layer is shown in the upper left corner of the display. Layers 1-4 or All can be selected by positioning the cursor on this field and using the Data Entry Control to change the layer. In the screen shown below, Layer 1 is selected.

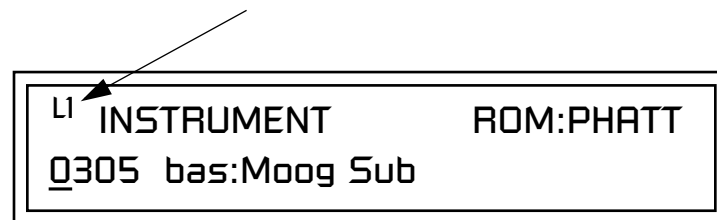

When "All Layers" (A) is selected, the existing parameter value for any field will be displayed if all layers are equal. If the layer parameter values are NOT equal, the value of Layer 1 will be displayed with flashing characters. If you move the Data Entry Control all values will be equal to this new value and the parameter value will no longer flash.

Defining Layer Parameters

Selecting an Instrument

The Edit menu parameters define the four layers and include the instrument assigned to the layer, the ranges of the layer, tuning, envelopes, filters, and patch cords. These parameters are defined for each layer on an individual basis (based on the currently selected layer). See “Common Preset Parameters” on page 146 for global preset settings.

The Instrument parameter defines which of the available instrument sounds is played by the current layer.

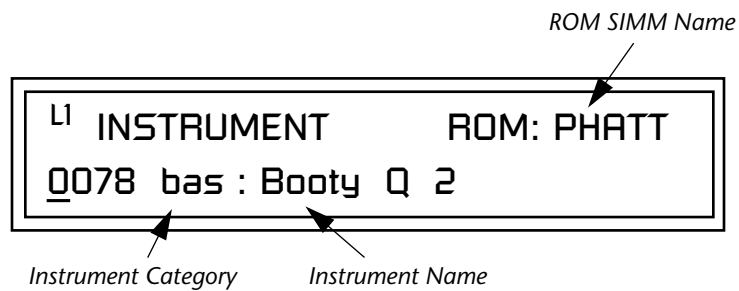

To select an instrument for the selected layer(s), move the cursor to the bottom line of the display and change the instrument using the Data Entry Control.

Sound Navigator

Sound Navigator also works to help select Instruments although the category names are predefined. When the cursor is on the Instrument Category field, turning the Data Entry Control selects different instrument categories. The Name Field will change to show the first instrument in each category. Move the cursor to the instrument name to select instruments in the selected category.

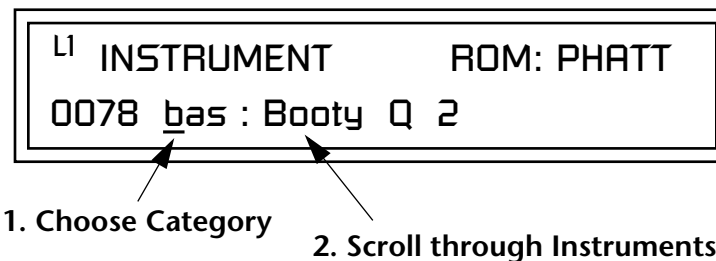

Selecting Categories of Instruments using Sound Navigator.

Defining Key Range

The Key parameter defines the range on the keyboard used by the current layer. The Key range is from C-2 through G8.

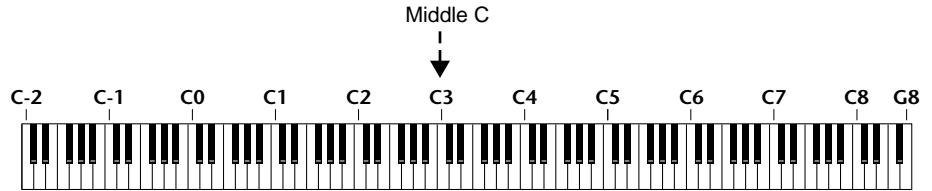

To define the range, set the low key value and the high key value.

You can select key numbers by simply pressing the desired keyboard key when the cursor is positioned on the low or high key field in the display.

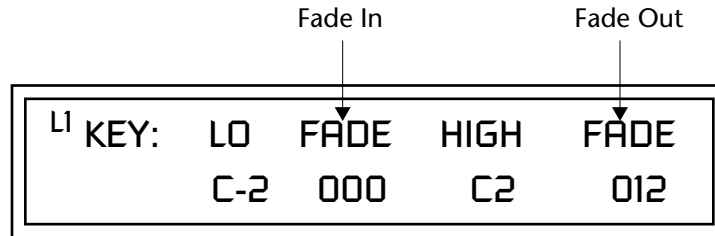

Layers can be crossfaded according to key position by adjusting the Low and High Fade parameters. The first Fade field determines how many semitones it takes the layer to Fade In from the low key. The second Fade field determines how many semitones it takes the layer to Fade Out to the high key. The screen shot above and the diagram below show Layer 1 being faded out over a one octave range.

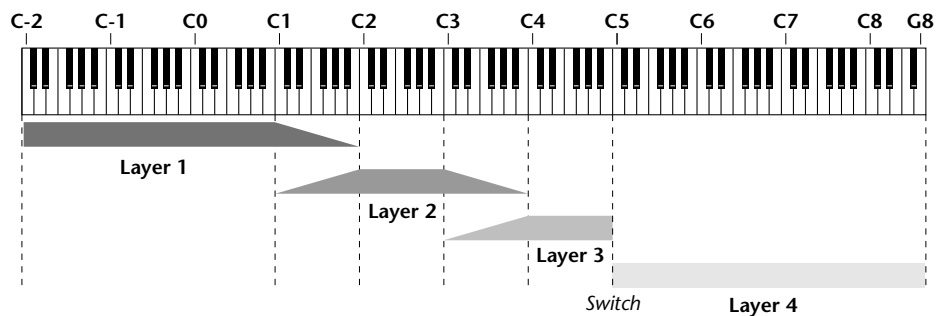

With a High Fade value of zero (as in layer 3 of the diagram), the layer simply switches off at the high key.

► **To Switch Layers According to Key Position**

The Key Range parameter allows you to create a “split” keyboard with up to four sounds adjacent to each other on the keyboard. This is shown in the diagram below.

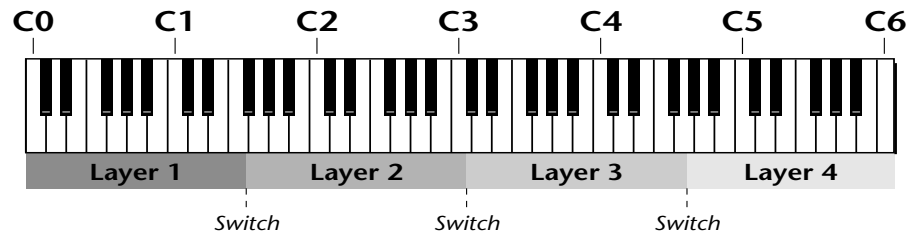

Just assign the low and high key range for each of the four layers with Fade set to zero. Set the Low and High Keys so they don't overlap other layers.

 You can select key numbers by simply pressing the desired keyboard key when the cursor is positioned on the low or high key field in the display.

L ¹ KEY: LO	FADE	HIGH	FADE
<u>C</u> 0	000	F1	000

L ² KEY: LO	FADE	HIGH	FADE
<u>F</u> #1	000	C3	000

L ³ KEY: LO	FADE	HIGH	FADE
<u>C</u> #3	000	F#4	000

L ⁴ KEY: LO	FADE	HIGH	FADE
<u>G</u> 4	000	C6	000

If two layers do overlap, both will play as shown in the next example.

► **To Stack Layers**

If the ranges of two or more Layers overlap it is called *stacking layers*. All Layers assigned to a key sound when the key is played. This is shown in the following diagram. It's very easy to stack layers. Simply duplicate the key ranges for any layers you want to stack.

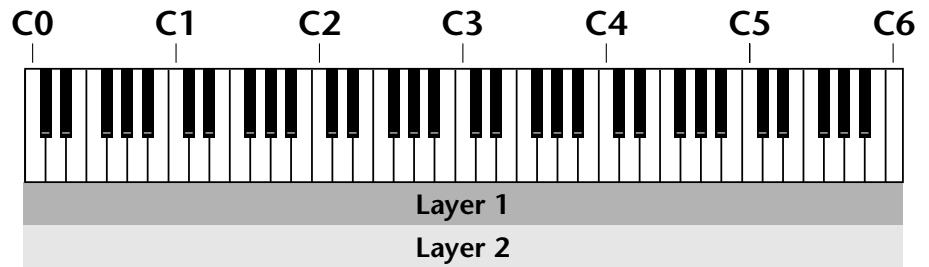

L ¹ KEY:	LO	FADE	HIGH	FADE
	<u>C</u> 0	000	C6	000

L ² KEY:	LO	FADE	HIGH	FADE
	<u>C</u> 0	000	C6	000

Defining the Velocity Crossfade Range

Velocity is a measure of how hard the key is pressed. Velocity Range lets you control the volume of the layers using velocity. Using this function you can crossfade or cross-switch between layers according to how hard you play the keyboard.

Set the velocity range of the layer by defining the high and low velocity values. Values range from 0 (off) to 127 (hardest).

L ² VEL:	LO	FADE	HIGH	FADE
	<u>36</u>	012	96	012

The Fade fields define the velocity crossfade range for the currently selected layer. The first Fade field defines the Fade In range for the low velocity value. The second defines the Fade Out range for the high velocity value.

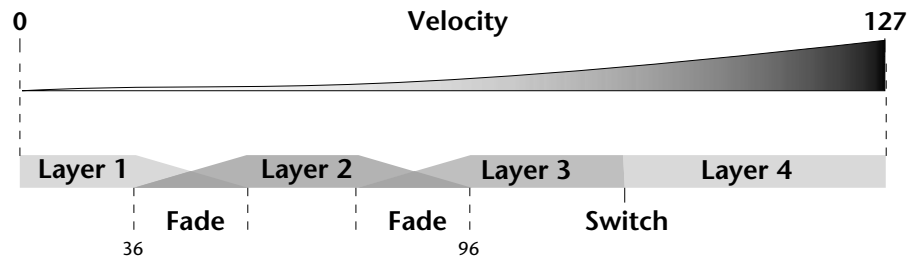

With soft playing, Layer 1 sounds. As you play harder, Layer 1 gradually fades out and Layer 2 fades in. When the keyboard is played hard, Layer 3 plays.

► To Set Up a Velocity Crossfade Between Layers

Set the velocity fades so that layer 1 fades out with higher key velocity, while layer 2 fades in. At a velocity of 64, the two sounds are equal volume. You may want to adjust the fade in and fade out points to achieve a natural sounding crossfade. These parameters vary depending on the sounds.

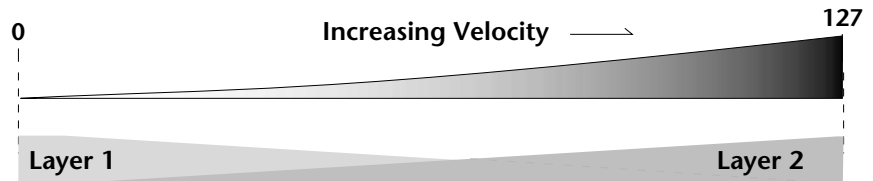

L ¹ VEL:	LO	FADE	HIGH	FADE
	<u>000</u>	000	127	127

L ² VEL:	LO	FADE	HIGH	FADE
	<u>000</u>	127	127	000

Defining the Real-time Crossfade Range

The Real-time Crossfade window lets you control the volume of the four layers using a real-time controller such as a front panel knob, a pedal or an LFO or Envelope generator. The controller is defined by the PatchCord parameter (see “PatchCords” on page 142).

The Fade fields define the crossfade range in velocity for the currently selected layer. The first Fade field defines the Fade In amount for the low Real-time Control value. The second defines the Fade Out amount for the high Real-time Control value. The Fade value range is from 0 to 127.

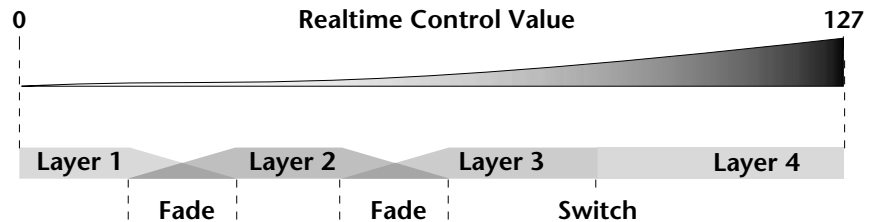

After the Ranges and Fades have been adjusted for each layer in the Real-time Crossfade screen, you must assign a real-time controller to RTXfade (Real-time Crossfade) on each Layer in the PatchCord screen. Set the PatchCord Amounts to +100.

► To Set Up a Real-time Crossfade Between Two Layers

As the real-time control (knob, pedal, LFO, etc.) is increased, Layer 1 fades out as Layer 2 fades in. This example only uses two of the possible four layers. Refer to the screen diagrams below.

L1	RT:	LO	FADE	HIGH	FADE
		000	000	127	127

L2	RT:	LO	FADE	HIGH	FADE
		000	127	127	000

1. Select a preset.
2. Press the Edit button to access the Edit menu.
3. Go to the Instrument page and select instruments for Layers 1 and 2.

4. Press Enter, then use the Data Entry Control to advance to the Real-time Crossfade page.
5. Define the High and Low range of each Layer. In this example the entire range of 0-127 is used.
6. Define the Fades for each Layer. This is just an initial setting. The Range and Fade parameters may have to be adjusted later to get a smooth crossfade.
7. Press Home/Enter and use the Data Entry Control to advance to the PatchCord page. Select Layer 1.
8. Select the modulation source for the crossfade (knob, pedal, LFO, Envelope) and set the destination to RTXfade. Set the Cord Amount to +100.
9. Select Layer 2. Select the same source and destination for the crossfade and set the Cord Amount to +127.

L1 PATCHCORD	#01
MidiA -> RTXfade	+100

10. Play the keyboard while adjusting the real-time controller. Go back to the Real-time Crossfade screens to fine tune the crossfade if necessary. Decreasing the fade size will narrow the region where both layers are sounding.

► **To Randomly Cross-Switch Between Four Layers**

In certain situations, you may want to switch between several layers randomly. **Crossfade Random** is a modulation source specifically designed to handle this situation. Unlike the other random sources, Crossfade Random generates one random number for all layers each time a key is pressed.

To set up a four layer Cross-Switch, simply assign each of the four layers to a different Real-time Crossfade range, then assign XfdRnd to RTXfade in the PatchCords for each layer.

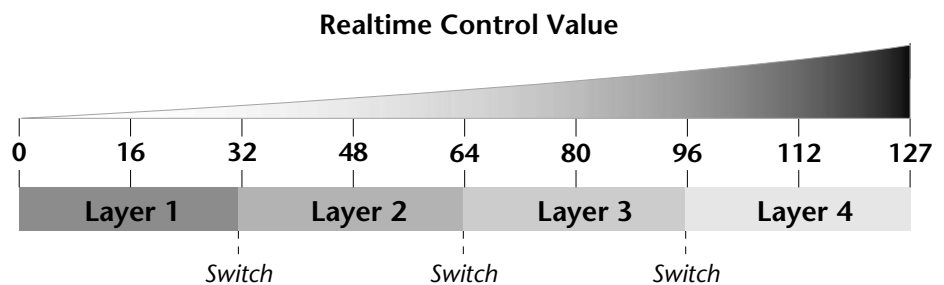

1. Press the Edit button to access the Edit menu.
2. Go to the Instrument screen and select Instruments for Layers 1 through 4.
3. Press Enter, then use the Data Entry Control to advance to the Real-time Crossfade page.

L1	RT:	LO	FADE	HIGH	FADE
		000	000	<u>031</u>	000

L2	RT:	LO	FADE	HIGH	FADE
		<u>032</u>	000	063	000

L3	RT:	LO	FADE	HIGH	FADE
		<u>064</u>	000	095	000

L4	RT:	LO	FADE	HIGH	FADE
		09 <u>6</u>	000	127	000

4. Define the High and Low range of each Layer as shown above.
5. Press Home/Enter and use the Data Entry Control to advance to the PatchCord page. Select Layer 1.
6. Select XfdRnd as the modulation source and RTXfade as the destination. Set the Cord Amount to +100.
7. Repeat step 6 for the remaining three layers.

*Transposing the
Instrument*

```
L1 PATCHCORD #01
XfdRand -> RTXfade +100
```

8. That's it! Now set each Layer up the way you want. Try radically different instruments, filter settings, or tunings. Or you can make each layer just slightly different for a more natural effect. Try adjusting the Fades or overlapping the ranges if you want more than one layer to play at once.

The Transpose parameter lets you transpose the key of the current layer's Instrument. Transpose works by shifting the keyboard position in semitone intervals relative to middle C. Use this parameter to transpose different layers apart by semitone intervals. For example, by transposing one layer by +7 semitones, it will track other layers at a perfect fifth interval.



The range of transposition is -36 to +36 semitones.

```
L1 TRANSPOSE
+36 semitones
```

Tuning

The Tuning parameter changes the pitch of the key in semitone and 1/64 semitone intervals.

L1 <u>T</u> UNING			
Coarse:	+36	Fine:	+63

Use the Coarse field to shift the tuning by semitone intervals. Use the Fine field to shift tuning by 1/64 semitones (or 1.56 cents) intervals.

Background: Transpose vs. Coarse Tuning

Transpose works by shifting the keyboard assignment of the Instrument (as if you were sliding the keyboard up and down with the Instrument remaining in the same position). Coarse Tuning keeps the instrument placement on the keyboard and actually tunes the samples up using a digital process called interpolation. Use Course Tuning on drum instruments to change the pitch while keeping sample placement constant. Coarse Tuning can also be useful to slightly change the timbre of the instrument.

Amplifier

This parameter sets the initial volume and pan position of the current layer. These values can be changed using any Real-time Controller set up in the PatchCords. The value range for the volume is from -96 dB to +10 dB. 0 dB is the default setting. Routinely turning the volume up to +10 dB is not recommended because it doesn't allow other modulation sources to increase the volume further.

L1 <u>A</u> MPLIFIER			
Volume:	+10dB	Pan:	48L

This field determines the initial Pan value for the current layer. The value range for Pan is from 64L to 0 (left) and 0 to 63R (right). Pan adjusts the volume into the left and right output channels relative to the Pan setting in the main Preset Select screen (see "Channel Pan" on page 32). So, if you, for example, set the Pan value in the Preset Select screen to 64L and set this Pan value to 63R, the actual pan amount would be 0 as these two pan parameters are relative to each other.

Volume Envelope

 *Factory Mode is useful for Instruments containing multiple drums, since each drum can have its own envelope settings.*

 *If two adjacent segments have the same level in a "time-based" envelope, the segment will be skipped. Adjacent segments must have different levels for the rate control to work.*

 *See "Base Tempo (Master Clock)" on page 36.*

An envelope can be described as a "contour" which is used to shape the sound over time. The *Volume Envelope* controls the volume of the sound in the current layer over time. The way the volume of a sound evolves has a profound effect on how we perceive the sound.

Each instrument has its own Factory preset Volume Envelope setting. The Volume Envelope allows you to program your own envelope settings.

Selecting the Mode

The Mode field determines whether the layer will use the instrument's default envelope (Factory) or use the user-programmed Volume Envelope. There are three mode options and repeat.

- **Factory:** Uses the factory preset envelope contained in each instrument. If you select the "Factory" mode, the Volume Envelope parameters are disabled and the factory defined settings are used instead.

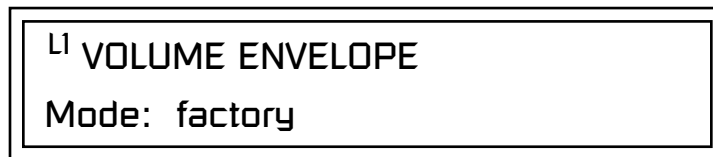

- **Time-based:** Defines the Volume Envelope rates from 0 to 127 (approximately 1 ms to 160 seconds). The Master clock has no affect on time-based rates.
- **Tempo-based:** The Volume Envelope times vary based on the master tempo setting. Note values are displayed instead of a number when the time corresponds to an exact note value. Tempo-based envelopes are useful when using external sequencers and arpeggiators because the envelope rates compress and expand according to the Master Clock setting, keeping the envelopes in sync with the sequence or arpeggio.

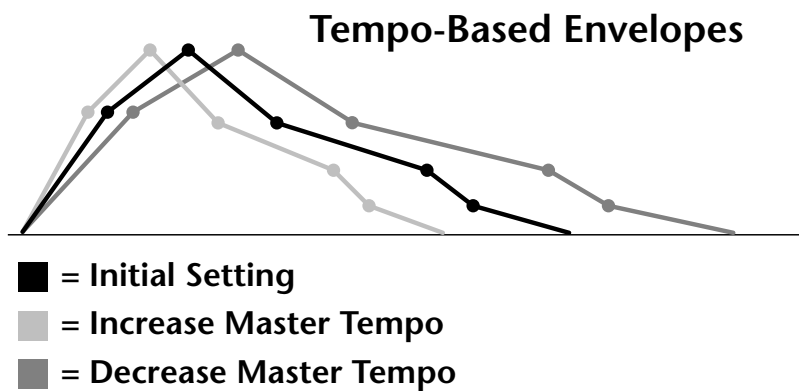

Tempo-based envelope rates change according to the Master Clock rate.

 See the Programming Basics section of this manual for detailed information about how the Envelopes work.

Defining the Volume Envelope

The Volume Envelope controls the volume of the layer over time. The Volume Envelope has six stages to the contour: Attack 1, Attack 2, Decay 1, Decay 2, Release 1 and Release 2. When a key is pressed, the Envelope goes through the first four stages. If you continue to hold down the key, the envelope holds at the Decay 2 level. When the key is released, the envelope continues through the Release stages ending at the Release 2 level.

L1	VOL ENV	RATE	LEVEL
	<u>A</u> ttack 1	84	100%

As soon as the Attack 1 level is reached, the Attack 2 phase begins. When the Attack 2 Level is reached, the Decay 1 phase begins. When the key is released, the envelope immediately jumps to the Release 1 stage, then the Release 2 stage finally ending at the Release 2 level.

If you have selected the factory mode, the Volume Envelope parameter screen looks like the following illustration.

L1	VOL ENV	RATE	LEVEL
	(using factory envelope)		

 If the Release 2 level is set at a value other than zero, the note will continue to sound after the key is released. This might be useful for drone effects, but the channel won't stop sounding until all channels are used up.

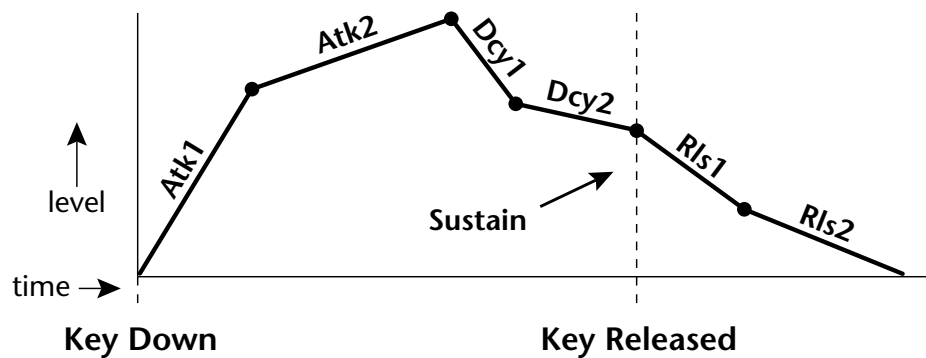

On the Volume Envelope, levels can only be set to positive values. The value range is from 0 to +100.

Chorusing the Layer



WARNING: Because it works by doubling instruments, Chorusing halves the number of notes you can play.

Chorusing “thickens” the sound by doubling the sound in stereo and then detuning it. Every layer with chorus turned on uses twice the polyphony for that layer.

L1	CHORUS	WIDTH
	off	100%

The first field in this screen turns Chorus On or Off and allows you to adjust the amount of detuning (1 to 100%). The *Width* parameter controls the stereo spread. 0% reduces the chorus to mono and 100% provides the most stereo separation.

Sound Start Offset and Delay

Sound Start sets where the instrument begins playing when you hit a key. Setting the Start Offset amount to “0” plays the sample from the beginning. Higher values move the Sample Start Point further into the sample toward the end. There is also a PatchCord source which can be used to change the Sound Start point at note-on time.

L1	SOUND	START	DELAY
		127	127

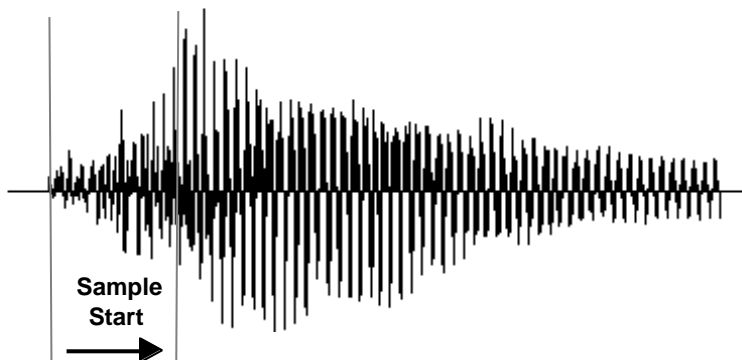

Controlling the Sound Start using Key Velocity (< Amt -) brings in the attack of the wave only when you play hard. This is especially effective with percussion instruments.

Delay defines the time between when you hit a key (note-on) and the onset of the current layer’s note and the start of the envelopes (if applicable). Delay values below zero are *Tempo-based* values, meaning the time is based on the Base Tempo (*Master Clock*) setting. Note values are displayed by adjusting the Delay Time value below zero. The sound will be delayed by the selected note value based on the master clock.

Non-Transpose Mode

This function turns keyboard transposition On or Off for the current layer. With Nontranspose “on,” the keyboard will not control the pitch of the instrument. This is a useful function for drones, attack “chiffs,” or other sound effects which you may not want to track the keyboard.



```
L1 NONTRANSPOSE
off
```

Solo Mode

Provides the playing action of a monophonic instrument such as a lead synthesizer by preventing more than one note from sounding at once. There are eight different solo modes provided. Try setting up different layers with different solo mode and glide rates or combine solo mode with polyphonic playing modes.



```
L1 SOLO MODE
synth (low)
```



In order to define a monophonic glide (see the Portamento parameter), you must be in Solo mode.

The Solo modes are:

Multiple Trigger: Last note priority. No key-up action. Retrigger envelopes and samples when a key is pressed.

Melody (last): Last note priority. No key-up action.

First solo note: Envelopes start at Attack segment from zero. Samples start at the beginning.

If previous note is releasing: Envelopes start at Attack segment, but from current level. Samples start at the beginning.

When playing “Legato”: Envelopes continue from current segment and level. Samples start at the loop or the beginning if unlooped.

Melody (low): Same as Melody (last), but with low note priority. Newly played keys which are higher than the lowest solo key held do not sound.

Melody (high): Same as Melody (last), but with high note priority. Newly played keys which are lower than the highest solo key held do not sound.

Synth (last): Similar to Melody (last) but this mode has key-up action. When you release the currently sounding solo key while holding other keys down, the highest held solo key sounds in a Legato fashion.

Assign Group

Synth (low): Same as Synth (last) but with low note priority. When you release the currently sounding solo key while holding other keys down, the lowest held solo key sounds in a Legato fashion (MiniMoog).

Synth (high): Same as Synth (last) but with high note priority. When you release the currently sounding solo key while holding other keys down, the highest held solo key sounds in a Legato fashion.

Fingered Glide: Same as Synth (last), except that Glide is disabled when playing Staccato, enabled when playing Legato.

Use the Assign Group parameter to assign a certain number of channels to each layer. By assigning all voices in the preset to assign groups, important parts are protected from being “stolen” by more recently played keys. Or you can assign a voice, such as an open high hat, to a mono channel so it is cancelled by a closed high hat on the same mono channel. Layers rotate within their assigned “bin” of channels, not interfering with other bins.



The modes are:

Poly All: Notes are played polyphonically with dynamic channel assignment using all 64 channels.

Poly 16 A-B: Two bins of 16 channels each. Notes are played polyphonically with dynamic channel assignment using no more than 16 channels.

Poly 8 A-D: Four bins of 8 channels each. Notes are played polyphonically with dynamic channel assignment using no more than 8 channels each.

Poly 4 A-D: Four bins of 4 channels each. Notes are played polyphonically with dynamic channel assignment using no more than 4 channels each.

Poly 2 A-D: Four bins of 2 channels each. Notes are played polyphonically with dynamic channel assignment using no more than 2 channels each.

Mono A-I: Nine monophonic channels, Any layers assigned to the same letter interrupt each other without affecting other layers.

Glide

Glide creates a smooth transition from one note to the next instead of the normal instantaneous change in pitch when a new key is pressed. This effect is commonly heard on slide guitars, synthesizers and violins.

L1	GLIDE RATE	CURVE
	0.000 sec/oct	linear

The **Glide Rate** parameter defines the time it takes to glide to the new pitch (the larger the value, the slower the glide rate) The glide rate value range is from 0 through 32.738 seconds (zero means off).

The **Glide Curve** describes how the glide accelerates as it slides between notes. Because of the ear's non-linear response to pitch, a linear glide sounds slow at the beginning and speeds up toward the end. Exponential curves actually sound smoother and more linear. Eight exponential curves are provided. Choose one that suits your style.

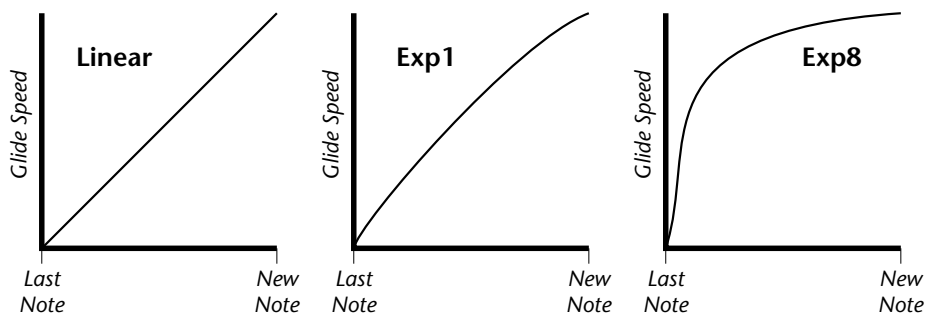

Glide can be either polyphonic or monophonic depending of the state of *Solo Mode*.

Z-Plane Filters

A filter is a device which changes the output of a signal (sound) by removing certain elements of the signal based on the frequency and amplitude. The "Order" of a filter defines the number of filter elements it contains. The more elements, the more complex the filter.

Mo'Phatt contains 50 different types of E-MU's celebrated Z-plane filters. In addition to the standard Low pass, High pass and Band pass filters, Mo'Phatt contains Swept Octave Equalizers, Phasers, Flangers, Vocal Formant Filters, and digital models of classic synthesizer filters.

In the filter chart below you will notice that the "Order" of the filters varies from 2 to 12 order. Higher order filters have more sections and can produce more complex formants. Mo'Phatt can produce 64 filters of up to 6th order or 32 filters of 12th order complexity. Therefore, if you decided to use all

12th order filters, Mo'Phatt would be limited to 32 voices. *See page 101 for more information about filters.*

Mo'Phatt Filter Types

This screen allows you to choose the type of filter for the current layer.

L1 FILTER	Ord	Type
Phazer 2 E4	6	PHA

Filter Types	
LPF	Low-pass filter
PHA	Phaser
HPF	High-pass filter
FLG	Flanger
BPF	Band-pass filter
VOW	Vowel/ formant
EQ+	EQ boost
EQ-	EQ cut
SFX	Special Effect

Filter Name	Order	Type	Description
Smooth	02	LPF	Typical OB type low-pass filter with a shallow 12 dB/octave slope.
Classic	04	LPF	4-pole low-pass filter, the standard filter on classic analog synths. 24 dB/octave rolloff.
Steeper	06	LPF	6-pole low-pass filter which has a steeper slope than a 4-pole low-pass filter. 36 dB/octave rolloff!
MegaSweepz	12	LPF	“Loud” LPF with a hard Q. Tweeters beware!
EarlyRizer	12	LPF	Classic analog sweeping with hot Q and Lo-end.
Millennium	12	LPF	Aggressive low-pass filter. Q gives you a variety of spiky tonal peaks.
KlubKlassik	12	LPF	Responsive low-pass filter sweep with a wide spectrum of Q sounds
BassBox-303	12	LPF	Pumped up lows with TB-like squelchy Q factor.
Shallow	02	HPF	2-pole high-pass filter. 12 dB/octave slope.
Deeper	04	HPF	Classic 4-pole high-pass filter. Cutoff sweep progressively cuts 4th Order High-pass.
Band-pass1	02	BPF	Band-pass filter with 6 dB/octave rolloff on either side of the passband and Q control.
Band-pass2	04	BPF	Band-pass filter with 12 dB/octave rolloff on either side of the passband and Q control.
ContraBand	06	BPF	A novel band-pass filter where the frequency peaks and dips midway in the frequency range.
Swept1>1oct	06	EQ+	Parametric filter with 24 dB of boost or cut and a one octave bandwidth.
Swept2>1oct	06	EQ+	Parametric filter with 24 dB of boost or cut. The bandwidth of the filter is two octaves wide at the low end of the audio spectrum, gradually changing to one octave wide at the upper end of the spectrum.

Filter Name	Order	Type	Description
Swept3>1oct	06	EQ+	Parametric filter with 24 dB of boost or cut. The bandwidth of the filter is three octaves wide at the low end of the audio spectrum, gradually changing to one octave wide at the upper end of the spectrum.
DJAlkaline	12	EQ+	Band accentuating filter, Q shifts "ring" frequency.
AceOfBass	12	EQ+	Bass-boost to bass-cut morph
TB-OrNot-TB	12	EQ+	Great Bassline "Processor."
BolandBass	12	EQ+	Constant bass boost with mid-tone Q control.
BassTracer	12	EQ+	Low Q boosts bass. Try sawtooth or square waveform with Q set to 115.
RogueHertz	12	EQ+	Bass with mid-range boost and smooth Q. Sweep cutoff with Q at 127.
RazorBlades	12	EQ-	Cuts a series of frequency bands. Q selects different bands.
RadioCraze	12	EQ-	Band limited for a cheap radio-like EQ
AahAyEeh	06	VOW	Vowel formant filter which sweeps from "Ah" sound, through "Ay" sound to "Ee" sound at maximum frequency setting. Q varies the apparent size of the mouth cavity.
Ooh-To-Aah	06	VOW	Vowel formant filter which sweeps from "Oo" sound, through "Oh" sound to "Ah" sound at maximum frequency setting. Q varies the apparent size of mouth cavity.
MultiQVox	12	VOW	Multi-Formant, Map Q To velocity.
Ooh-To-Eee	12	VOW	Oooh to Eeee formant morph.
TalkingHedz	12	VOW	"Oui" morphing filter. Q adds peaks.
Eeh-To-Aah	12	VOW	"E" to "Ah" formant movement. Q accentuates "peakiness."
UbuOrator	12	VOW	Aah-Uuh vowel with no Q. Raise Q for throaty vocals.
DeepBouche	12	VOW	French vowels! "Ou-Est" vowel at low Q.
PhazeShift1	06	PHA	Recreates a comb filter effect typical of phase shifters. Frequency moves position of notches. Q varies the depth of the notches.
PhazeShift2	06	PHA	Comb filter with slightly different notch frequency moving the frequency of notches. Q varies the depth of the notches.
FreakShifta	12	PHA	Phasey movement. Try major 6 interval and maximum Q.
CruzPusher	12	PHA	Accentuates harmonics at high Q. Try with a sawtooth LFO.

Filter Name	Order	Type	Description
FlangerLite	06	FLG	Contains three notches. Frequency moves frequency and spacing of notches. Q increases flanging depth.
AngelzHairz	12	FLG	Smooth sweep flanger. Good with vox waves. eg. I094, Q =60
DreamWeava	12	FLG	Directional Flanger. Poles shift down at low Q and up at high Q.
MeatyGizmo	12	REZ	Filter inverts at mid-Q.
DeadRinger	12	REZ	Permanent "Ringy" Q response. Many Q variations.
ZoomPeaks	12	REZ	High resonance nasal filter.
AcidRavage	12	REZ	Great analog Q response. Wide tonal range. Try with a sawtooth LFO.
BassOMatic	12	REZ	Low boost for basslines. Q goes to distortion at the maximum level.
LucifersQ	12	REZ	Violent mid Q filter! Take care with Q values 40-90.
ToothComb	12	REZ	Highly resonant harmonic peaks shift in unison. Try mid Q.
EarBender	12	WAH	Midway between wah & vowel. Strong mid-boost. Nasty at high Q settings.
FuzziFace	12	DST	Nasty clipped distortion. Q functions as mid-frequency tone control.
BlissBatz	06	SFX	Bat phaser from the Emulator 4.
KlangKling	12	SFX	Ringing Flange filter. Q "tunes" the ring frequency.

Filter Parameters

The Freq and Q parameters control various elements of the filter depending on the type of filter used. See the table in the *Filter Types* section for details about what the Freq and Q fields control in each filter.

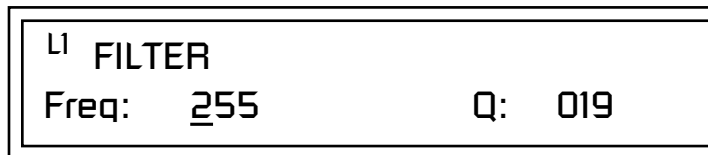

Filter Envelope

The Filter Envelope is normally used to control the filter frequency and has six stages. Unlike the Volume Envelope, the Filter Envelope must be patched to the Filter Frequency using a PatchCord. In this respect, it can be thought of as a general purpose envelope generator which is normally patched to control the filter. The Filter Envelope Levels can be negative as well as positive.

There are three mode options:

- **Time-based:** Defines the Filter Envelope rates from 0 to 127 (approximately 1 ms to 160 seconds). The Master clock has no affect on time-based rates.

L1	FILT ENV	RATE	LEVEL
	Attack 1	<u>8</u> 4	100%

- **Tempo-based:** The Filter Envelope times vary based on the Base Tempo setting and are displayed in values such as 1, 2, 3, etc. Note values are displayed instead of a number when the time corresponds to an exact note value. Tempo-based envelopes are useful when using arpeggiators and sequencers because the envelope rates compress and expand according to the Master Clock, keeping the envelopes in sync with the music. See the illustration on page 88.

L1	FILT ENV	RATE	LEVEL
	Attack 1	<u>1</u> /4	100%

- **Envelope Repeat:** The Envelope Generators can also be made to repeat. When the envelope repeat function is On, the Attack (1&2) and Decay (1&2) stages will continue to repeat as long as the key is held. As soon as the key is released, the envelope continues through its normal Release stages (1 & 2). For more information, see “Envelope Repeat” on page 88.

► **To Turn on Envelope Repeat:**

1. Move the cursor until it is underneath the Mode field as shown below.

L1	FILTER ENVELOPE
	<u>M</u> ode: time-based

2. Turn the data entry control clockwise. The lower line changes to:

L1	FILTER ENVELOPE
	Repeat: off

3. Move the cursor underneath the on/off field, then turn the data entry control clockwise so that Repeat is On.

 See “Base Tempo (Master Clock)” on page 36.

 See the Programming Basics section of this manual for detailed information about how the Envelopes work.

 The default PatchCord settings connect the Filter Envelope to Filter Frequency but the envelope can be routed to any real-time control destination using a PatchCord.

Defining the Filter Envelope

The Filter Envelope controls the filter frequency of the layer over time. The Envelope has six stages to the contour: Attack 1, Attack 2, Decay 1, Decay 2, Release 1 and Release 2. When a key is pressed, the Envelope goes through the first four stages. If the key continues to be held, the envelope holds at the Decay 2 level. When the key is released, the envelope immediately jumps to the Release 1 stage, then the Release 2 stage finally ending at the Release 2 level.

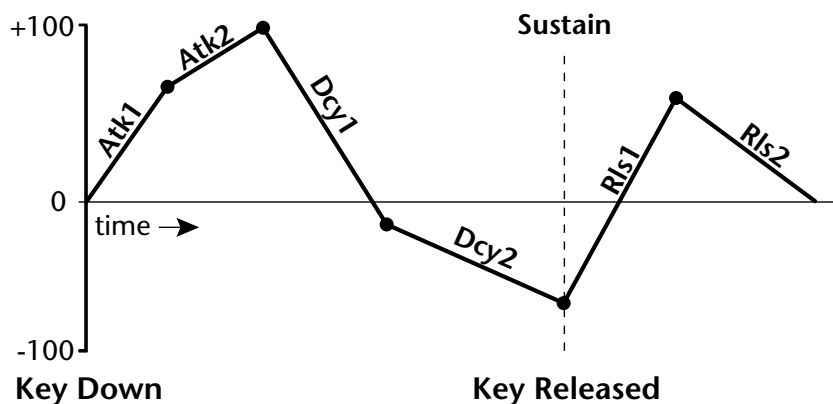

Auxiliary Envelope

The Auxiliary Envelope is a supplementary general purpose envelope that can be routed to any real-time control destination in the PatchCords. It is identical to the filter envelope generator. See “Filter Envelope” on page 135 for full details.

Low Frequency Oscillators (LFOs)

A Low Frequency Oscillator or LFO, is simply a wave that repeats at a slow speed. Mo’Phatt has two LFOs per layer identified on the display as LFO1 and LFO2.

An LFO can be routed to any real-time control destination using a PatchCord. LFOs have a myriad of uses, some of which probably haven’t been thought of yet. The following examples show a few common uses.

- Control the pitch of the sound (LFO -> Pitch). This effect is called “vibrato” and is an important performance tool. Many presets use this routing with the modulation wheel controlling “how much” modulation is applied.
- Create a “tremolo” effect by routing the LFO to control the volume (LFO -> AmpVolume).
- Add a bit of animation to the sound by routing the LFO to control the filter. Set the PatchCord amount low for a subtle effect.

The LFOs have five parameters: Shape, Sync, Rate, Delay and Variation.

Shape

LFO waveforms have different shapes. The shape of the waveform determines the effect of the LFO. LFOs have traditionally been used to add vibrato or repeating movement to a sound. These new shapes offer a lot of new programming possibilities.

If you modulate the pitch of an instrument, it's easy to visualize the shape of the waveform. For example, the sine wave has a smooth, rolling shape that changes the pitch smoothly. The square wave changes between two pitches abruptly. A sawtooth waveform increases the pitch smoothly, then abruptly changes back down. The available waveforms are shown below.

LFO Tricks & Tips:

- The Random LFO wave is truly random and is different for each voice and layer.
- The Pattern (Pat) waveforms will sound the same on different layers and voices.
- Sine + Noise is very useful for simulating trumpet and flute vibrato.

★ When routing Hemi-quaver to Pitch:

- +38 = major scale
- 38 = phrygian scale
- +76 = whole tone scale
- (+38) + (+76) = diminished (two cords)
- odd amount = S+H sound

Note: References to musical intervals in the pattern LFO shapes are with the LFO routed to pitch and a PatchCord amount of +38.

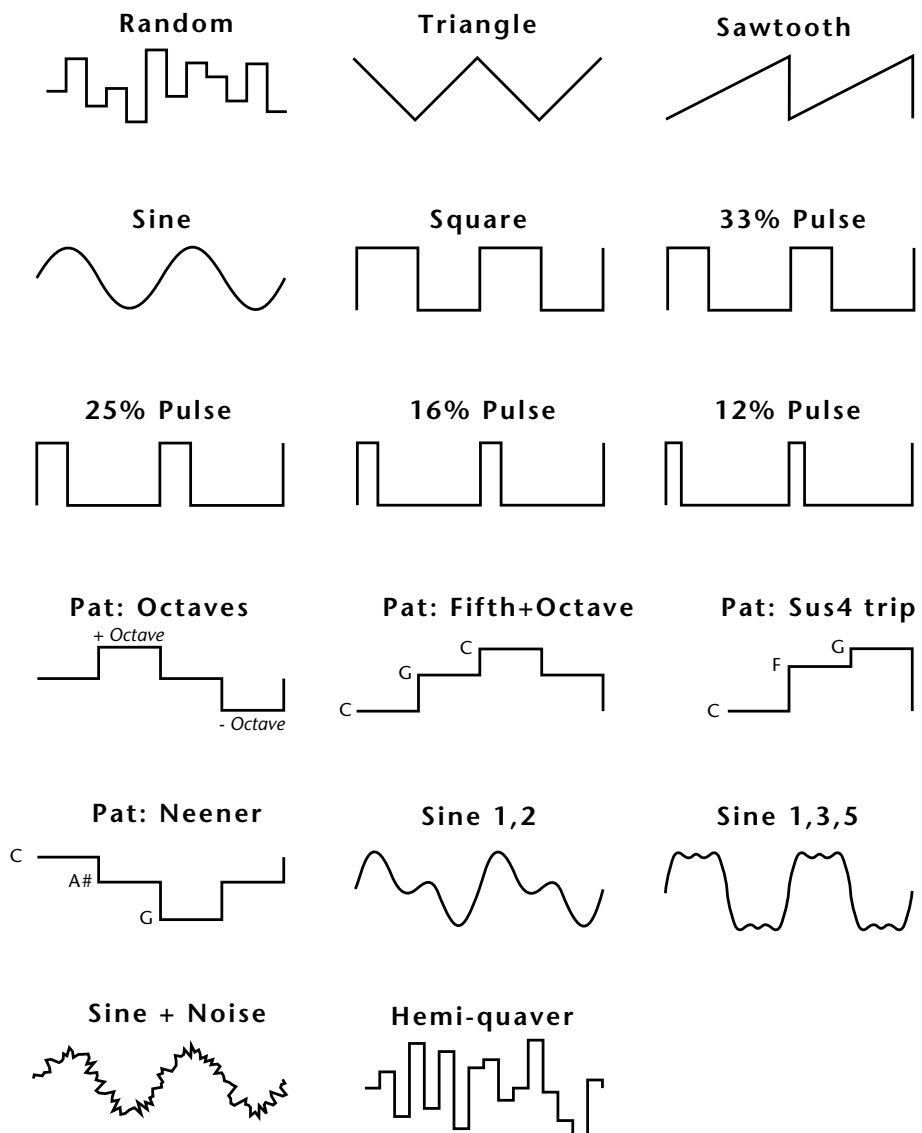

L1	LFO1	SHAPE	SYNC
		sawtooth	<u>key sync</u>

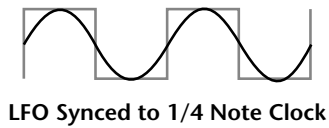

Sync

The Sync field specifies whether the LFO is synchronized to a key stroke or is Free Running. Key Sync starts the LFO wave at the beginning of its cycle each time you press a key on the controller. In Free Run mode, the LFO wave begins at a random point in its cycle each time you press a key on the controller.

Rate

The Rate field determines the LFO speed in absolute frequency rate values or tempo-based note values. All values equal to or greater than zero specify absolute frequency values from 0.08 Hz to 18.14 Hz.

Values less than zero specify tempo-based rates. If you modulate the rate of a tempo-based LFO, the rates will jump between the tempo-based note values with each PatchCord increment of "1". As an example: if the LFO rate was set to 8/1 and you patched the Mod Wheel to control rate with a PatchCord amount of +1, turning the Mod Wheel to maximum would change the LFO rate to 4/1d. Refer to the chart below.

L1	LFO1	RATE	DELAY	VAR
		<u>0.08Hz</u>	60	020

Tempo-based Rates (based on Master Clock Tempo)	Display
octal whole note	8/1
dotted quad whole note	4/1d
octal whole note triplet	8/1t
quad whole note	4/1
dotted double whole note	2/1d
quad whole note triplet	4/1t
double whole note	2/1
dotted whole note	1/1d

Tempo-based Rates (based on Master Clock Tempo)	Display
double note triplet	2/1t
whole note	1/1
dotted half note	1/2d
whole note triplet	1/1t
half note	1/2
dotted quarter note	1/4d
half note triplet	1/2t
quarter note	1/4
dotted 8th note	1/8d
quarter note triplet	1/4t
8th note	1/8
dotted 16th note	1/16d
8th note triplet	1/8t
16th note	1/16
dotted 32nd note	1/32d
16th note triplet	1/16t
32nd Note	1/32

Delay

The Delay parameter defines the amount of time between hitting a key on the controller and the onset of the LFO modulation. Delay can be used to simulate an effect often used by acoustic instrument players where the vibrato is brought in only after the initial note pitch is established. The following illustration demonstrates how delay works.

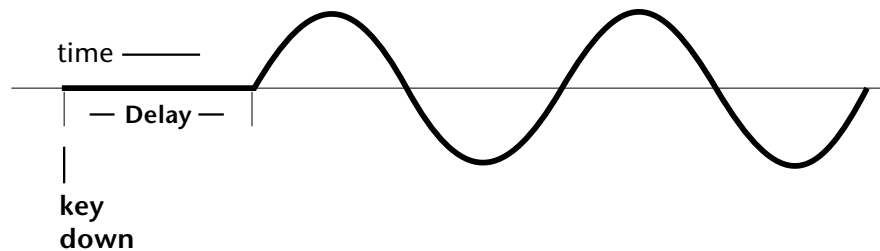

All Delay values equal to or greater than zero specify absolute time rates from 0 to 127. Values less than zero specify Tempo-based mode. Refer to the previous table for times and tempo-based rates.

Variation

LFO Variation sets the amount of random variation of the LFO each time you press a key on the controller. This creates a chorus or ensemble effect since each note played has a slightly different modulation rate. The higher the value entered, the greater the note to note variation in the LFO.

The Variation value range is from 0 through 100.



Variation is disabled when a Tempo-Based LFO is selected.

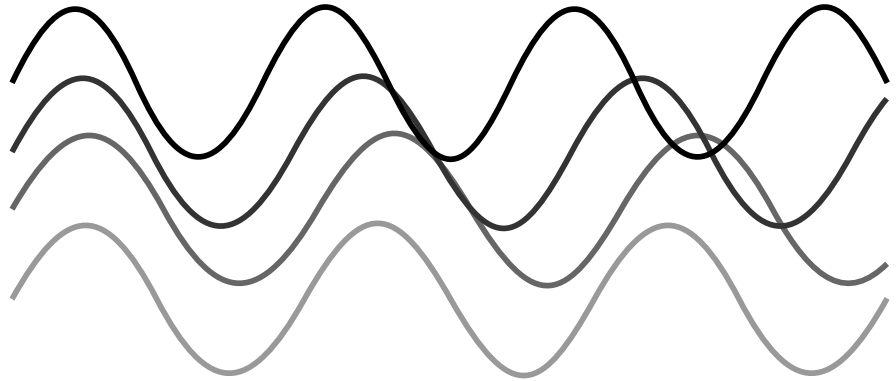

LFO variation changes the rate of each note to create an “ensemble” effect.

PatchCords

PatchCords tie everything together by connecting modulation sources to destinations. Each PatchCord has its own *Amount* control which can be positive or negative (negative amounts invert the signal). In addition, the PatchCord amounts themselves can be controlled by any modulation source. Mo'Phatt provides 24 patches for each layer.

There are three permanently connected control routings: volume envelope to amplifier, pitch wheel to pitch and key to pitch. All other connections must be made using the PatchCords.

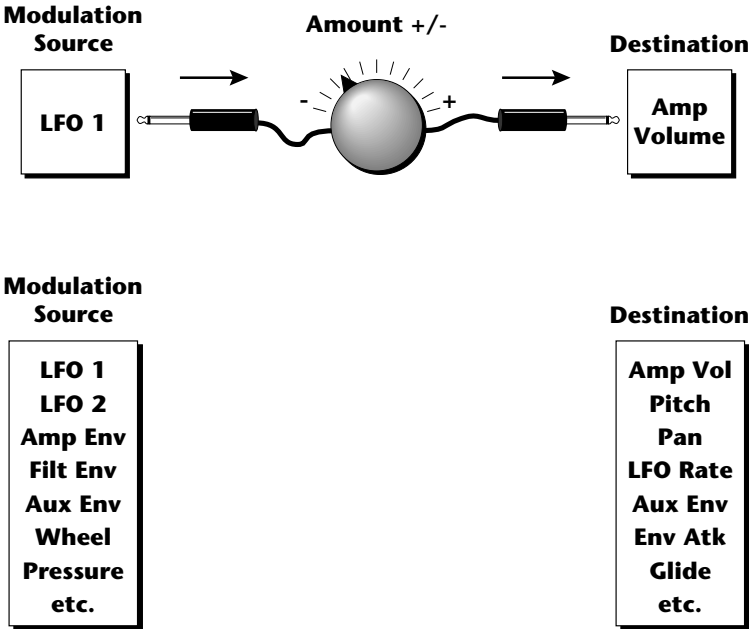

Each patch has an amount field which determines how much modulation is applied to the destination. The modulation amount can be positive or negative. Negative values invert the input. The amount value range is from -100 to +100.

```
L1 PATCHCORD #01
RlsVel -> AmpVol +100
```

```
L1 PATCHCORD #24
Key+ -> FiltRes -27
```

Modulator Polarity

You will notice that some of the modulation sources have symbols following their names. For example, there are three Velocity modulation sources, Vel +, Vel ±, and Vel <.

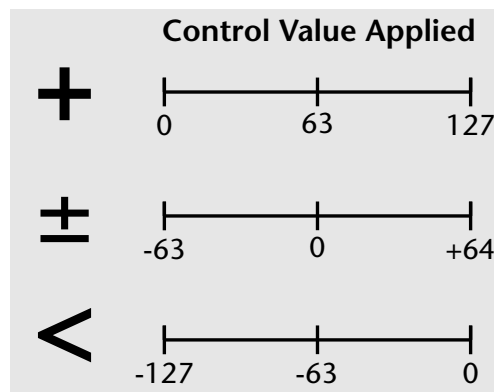
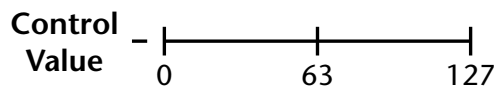

+ modulation ADDS to the initial value. (Normal)

± centers around Zero. (Use for LFOs, Filt. Freq.)

< modulation SUBTRACTS from the initial value

Note: Flip-Flop Footswitches 1 & 2 remain in their last condition when a new preset is selected. Flip-Flop Footswitch 3 resets to the Off condition whenever a new preset is selected.

“+” Modulation: Uses only the positive half of the range, adding to the current value. For example, if the filter frequency were set to 100 and you patched Vel+ to the filter, the filter frequency would increase from 100 as velocity was applied.

“±” Modulation: Uses both sides (full) range and both adding and subtracting from the current value. For example, if the filter frequency were set to 100 and you patched Vel ± to the filter, the filter frequency would decrease from 100 with key velocities of 63 or less and increase from 100 with key velocities of 64 and above. Therefore with medium velocity, the Filter frequency is approximately where you set it at 100.

An LFO ± works the same way; on the positive half of the cycle it increases the initial amount and on the negative half of the cycle it decreases the initial amount. With a ± modulation source, a value of 64 equals 0.

“<” Modulation: Uses only the negative half of the range, subtracting from the current value. For example, if the Amplifier Volume were set to +3 dB and you patched Vel < to AmpVol, the volume would be at +3 dB only when maximum key velocity were applied. Lower key velocities would scale back the volume. In general, < modulation is the proper choice when modulating Volume.

Refer to the following table for a list of modulation sources and destinations available in the Mo'Phatt.

Modulation Sources:

Off
 Key (+, ±)
 Velocity (+, ±, <)
 RlsVel (Release Velocity)
 Gate
 Pressure
 PitchWhl (Pitch Wheel)
 ModWhl (Modulation Wheel)
 Pedal
 MIDI A-L
 PLagOut (Preset Lag Out)
 PRampOut (Preset Ramp Out)
 FootSw1 - 3 (Foot Switch 1-3)
 FootFF (Flip-Flop Foot Switch 1 -3)
 MIDI Volume (Controller 7)
 MIDI Pan (Controller 10)
 MIDI Expression (Controller 11)
 KeyGlide
 VolEnv +, ±, < (Volume Envelope)
 FilEnv +, ±, < (Filter Envelope)
 AuxEnv +, ±, < (Auxiliary Envelope)
 LFO 1 & 2 (+, ±)
 White (White Noise)
 Pink (Pink Noise)
 XfdRand (Crossfade Random)
 KeyRand 1 & 2 (Key Random)
 Lag 0 sum (summing amp out)
 Lag 1 sum (summing amp out)
 Lag 0 & 1 (Lag Processor)
 Clk Divisors (Octal, Quad, Double Whole, Whole, Half, Qtr, 8th,16th)
 DC (DC Offset)
 Summing Amp
 Sum
 Switch
 Absolute Value
 Diode
 Flip-Flop
 Quantizer
 4x Gain

Modulation Destinations

Off
 KeySust (Key Sustain)
 FinePtch (Fine Pitch)
 Pitch
 Glide
 ChrsAmt (Chorus Amount)
 'SStart (Sample Start) -note-on)
 SLoop (Sample Loop)
 SRetrig (Sample Retrigger)
 FiltFreq (Filter Frequency)
 'FiltRes (Filter Resonance -note-on)
 AmpVol (Amplifier Volume)
 AmpPan (Amplifier Pan)
 RTXfade (Real-time Crossfade)
 VEnvRts (Volume Envelope Rates -all)
 VEnvAtk (Volume Envelope Attack)
 VEnvDcy (Volume Envelope Decay)
 VEnvRls (Volume Envelope Release)
 FEnvRts (Filter Envelope Rates -all)
 FEnvAtk (Filter Envelope Attack)
 FEnvDcy (Filter Envelope Decay)
 FEnvRls (Filter Envelope Release)
 FEnvTrig (Filter Envelope Trigger)
 AEnvRts (Auxiliary Envelope Rates -all)
 AEnvAtk (Auxiliary Envelope Attack)
 AEnvDcy (Auxiliary Envelope Decay)
 AEnvRls (Auxiliary Envelope Release)
 AEnvTrig (Auxiliary Envelope Trigger)
 LFO 1 & 2 Rate
 LFO 1 & 2 Trigger

 Lag Processor In 0 & 1
 Sum (Summing Amp)
 Switch
 Abs (Absolute Value)
 Diode
 Quantize
 Flip-Flop
 Gain 4x
 Cord 1-24 Amount

Pitch Bend Range

Specifies the Pitch Wheel range in semitones for the current layer. Pitch Wheel is a standard synthesizer control which is transmitted as a MIDI continuous controller message used (normally) to bend the pitch up and down.

The PitchBend range is from 0 to ± 12 semitones or "Master." A setting of "0" turns the pitch wheel Off for the current layer. The Master setting uses the Pitch Bend range defined in the *Master menu*.

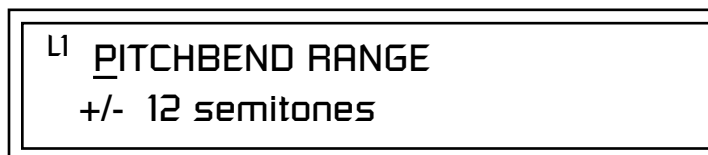

Mix Output

This feature allows you to program the Effect Send as a part of the preset. Note that for this feature to work, the Mix Output setting in the Master menu MUST be set to "Preset" on the selected MIDI channel. If you want to define output routing by MIDI channel, set it up using the Mix Output page in the Master menu. See "Mix Output" on page 67 for more information.

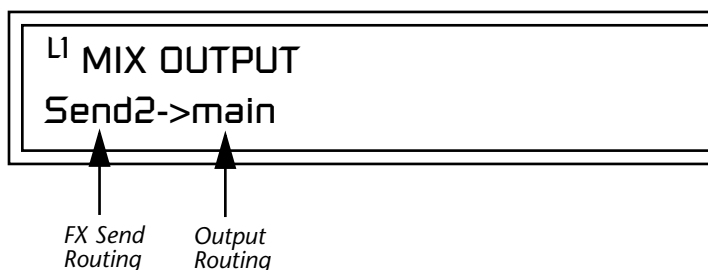

The Sends function as effect processor inputs (effect sends). The Output Routing field shows the true routing of the Sends to the Main output. The Output Routing never changes!

► To Control the Mix Output from the Preset:

1. Move the cursor until it is underneath the Layer field and change the Layer using the Data Entry Control.
2. Move the cursor until it is underneath the FX Send Routing field and change the Send (1-4) using the Data Entry Control.
3. Locate the MIX OUTPUT screen in the Master menu.
4. Set the MIDI channel you are using to "use preset".

Common Preset Parameters

Preset Effects

This section of the Edit menu chapter describes parameters that affect all layers in the preset.

Mo'Phatt has two stereo effects processors. When playing presets one at a time, the two processors can be programmed as part of the preset. The diagram below shows how the effects are integrated into the signal path using a parallel effects send/return model, similar to a mixing console.

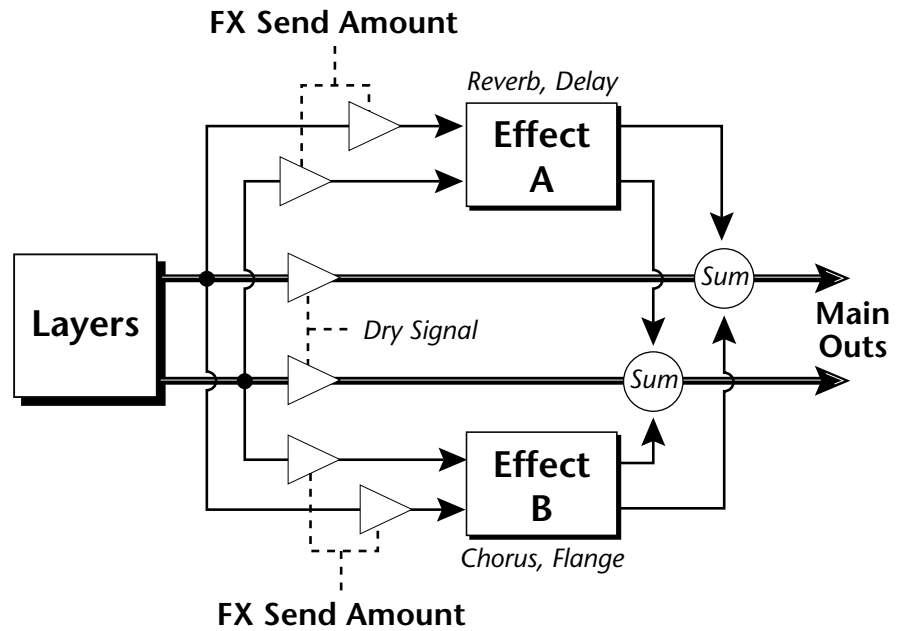

Refer to the Effects chapter for additional information and instructions for setting up both the Preset Effects and the Master Effects.

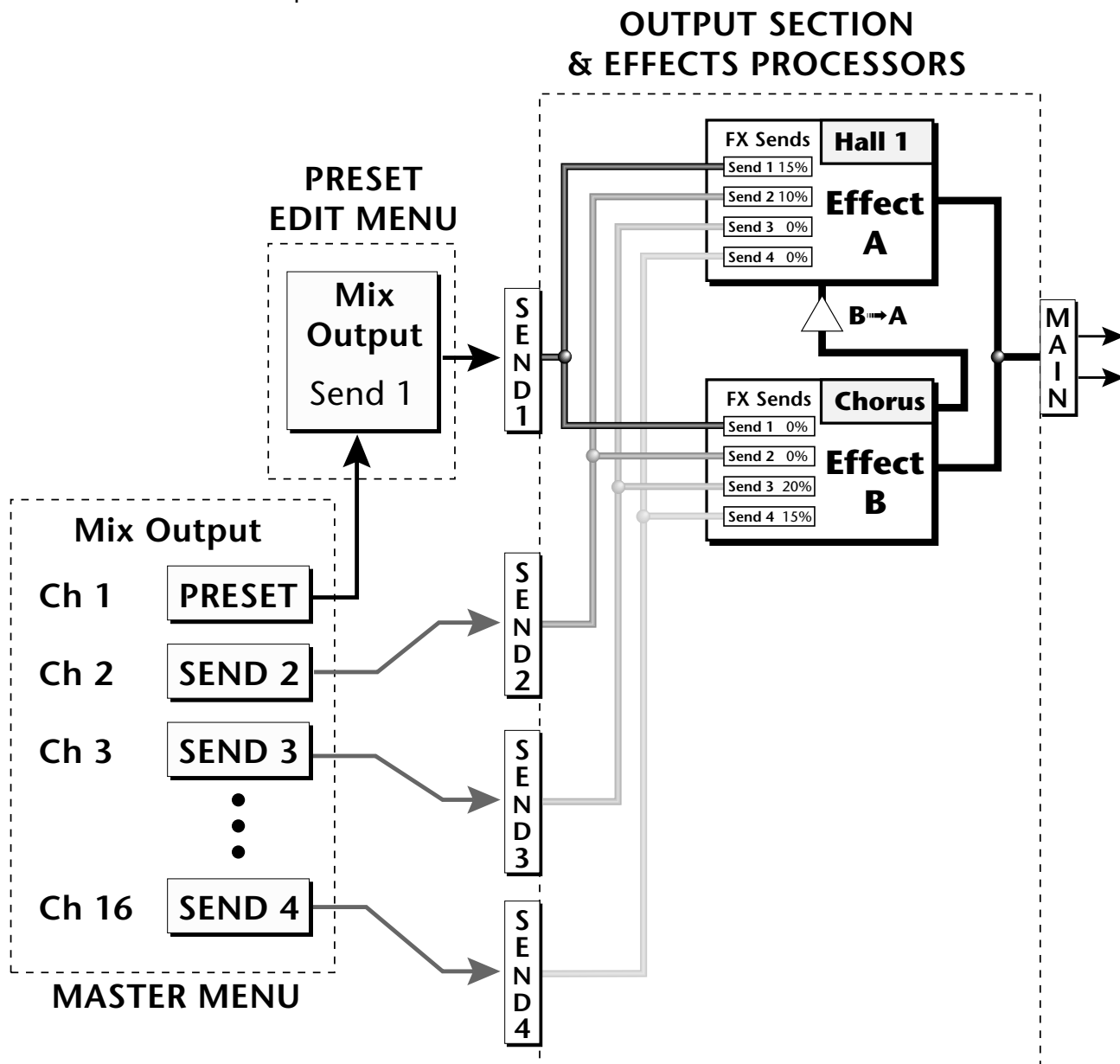

The Mix Output setting in the Master Menu determines if the Preset's Mix Output routing will be used. This allows the Sends to be programmed by either MIDI Channel or by Preset, whichever you prefer.

FXA Algorithm

This screen selects the effect type for Effect Processor A. The “A” effects consist of different reverb types and digital delays. Move the cursor to the lower line of the display and select the effect you want.

FXA ALGORITHM
Lg Concert Pan

A Effect Types

- | | |
|---------------------|-----------------------|
| 1. Room 1 | 23. BBall Court |
| 2. Room 2 | 24. Gymnasium |
| 3. Room 3 | 25. Cavern |
| 4. Hall 1 | 26. Concert 9 |
| 5. Hall 2 | 27. Concert 10 Pan |
| 6. Plate | 28. Reverse Gate |
| 7. Delay | 29. Gate 2 |
| 8. Panning Delay | 30. Gate Pan |
| 9. Multitap 1 | 31. Concert 11 |
| 10. Multitap Pan | 32. Medium Concert |
| 11. 3 Tap | 33. Large Concert |
| 12. 3 Tap Pan | 34. Large Concert Pan |
| 13. Soft Room | 35. Canyon |
| 14. Warm Room | 36. DelayVerb 1 |
| 15. Perfect Room | 37. DelayVerb 2 |
| 16. Tiled Room | 38. DelayVerb 3 |
| 17. Hard Plate | 39. DelayVerb 4 Pan |
| 18. Warm Hall | 40. DelayVerb 5 Pan |
| 19. Spacious Hall | 41. DelayVerb 6 |
| 20. Bright Hall | 42. DelayVerb 7 |
| 21. Bright Hall Pan | 43. DelayVerb 8 |
| 22. Bright Plate | 44. DelayVerb 9 |

FXA Parameters

The FXA parameters are Decay, High Frequency Damping, and the FxB to FxA send. **Decay** sets the length of time it takes an effect to fade out. **HF Damping** causes the high frequency energy to fade away more quickly during the reverb decay. **FxB to FxA** controls the amount of the “B” effect sent through effect “A”. This allows you to place the two effects in series and create setups such as “distortion through reverb” among others. Please refer to the Effects chapter for more information about the effects.

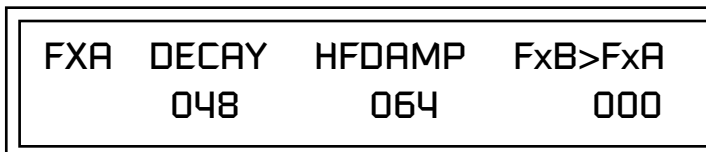

FXA Send Amounts

These parameters set the effects amounts for each of the four stereo effects busses.

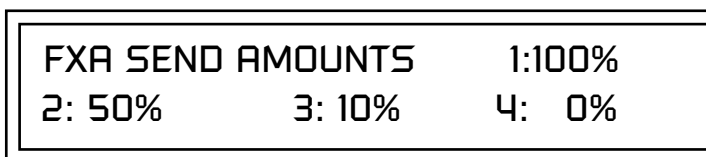

FXB Algorithm

This screen selects the effect type for Effect Processor A. Move the cursor to the lower line of the display and select the effect you want.



B Effect Types

- | | | |
|--------------|--------------------|-----------------------|
| 1. Chorus 1 | 12. Flange 5 | 23. PanDelay Chorus 1 |
| 2. Chorus 2 | 13. Flange 6 | 24. PanDelay Chorus 2 |
| 3. Chorus 3 | 14. Flange 7 | 25. Dual Tap 1/3 |
| 4. Chorus 4 | 15. Big Chorus | 26. Dual Tap 1/4 |
| 5. Chorus 5 | 16. Symphonic | 27. Vibrato |
| 6. Doubling | 17. Ensemble | 28. Distortion 1 |
| 7. Slapback | 18. Delay | 29. Distortion 2 |
| 8. Flange 1 | 19. Delay Stereo | 30. Distorted Flange |
| 9. Flange 2 | 20. Delay Stereo 2 | 31. Distorted Chorus |
| 10. Flange 3 | 21. Panning Delay | 32. Distorted Double |
| 11. Flange 4 | 22. Delay Chorus | |

FXB Parameters

The FXB parameters are Feedback, LFO Rate and Delay. **Feedback** sends the output of the effect back into the input. This creates multiple echoes on a delay effect and intensifies a chorus or flange effect. **LFO Rate** allows you to change the speed of the modulation oscillator for flange and chorus effects. **Delay** sets the length of the delay line. This affects the time between echoes, or the tone of flange effects.

FXB	FEEDBK	LFORATE	DELAY
	032	003	200ms

FXB Send Amounts

These parameters set the effects amounts for the four stereo effects busses.

FXB SEND AMOUNTS	1:100%
2: 50%	3: 10%
	4: 0%

Preset Patchcords

Preset PatchCords give you real-time control of global parameters. The effect processors are a powerful synthesis tool and this feature lets you control and use them in exciting new ways. For example, you can dynamically adjust the effects mix during a sequence or live performance.

There are many exciting performance possibilities using Preset PatchCords to control BEATs and Arpeggiator parameters. The front panel knobs “Wild 1-4” are usually connected to Arp and BEATs parameters in factory presets marked “arp:” or “bts:”. Likewise, Pitch and Mod wheels are often routed to “Beats Busy” and “Beats Variation” in factory presets marked “bts:”. Be sure to try out these controls

There are 12 Preset PatchCords per preset with a source, a destination and an amount control. The amount can be set from -100 to +100. The Preset PatchCord controls are *added* to the FX Send Amounts set in the Master or Edit menus. In other words, multiple sources connected to destinations are *summed*.



To crossfade between effects.

- 1) Set FXA Send 1 to 100%.
- 2) Set FXB Send 1 to 0%.
- 3) Set FX Cord #1 to FXA Send 1 at -100.
- 4) Set FX Cord #2 to FXB Send 1 at +100.

Increasing the controller amount will crossfade from FXA to FXB.

PRESET CORDS		#01
Pedal	-> FXBSend2	+100

Modulation Sources:

Off
PitchWhl (Pitch Wheel)
ModWhl (Modulation Wheel)
Pedal
MIDI Volume (Controller 7)
MIDI Pan (Controller 10)
MIDI Expression (Controller 11)
MIDI A-L
Footswitch 1
Flip-Flop Footswitch 1
Footswitch 2
Flip-Flop Footswitch 2
Footswitch 3
Flip-Flop Footswitch 3
DC

Modulation Destinations

Off
Effect A Send 1
Effect A Send 2
Effect A Send 3
Effect A Send 4
Effect B Send 1
Effect B Send 2
Effect B Send 3
Effect B Send 4
Preset Lag In
Preset Lag Amount
Preset Lag Rate
Preset Ramp Rate
Arp Resolution
Arp Extension
Arp Velocity
Arp Gate
Arp Interval
Beats Velocity Group 1-4
Beats Transpose (Xpose) Group 1-4
Beats Variation
Beats Busy

Initial Controller Amount

This parameter sets the initial value of MIDI controllers A-L when the preset is first selected. The front panel Control Knobs can be thought of as front panel MIDI controllers because in the Mo'Phatt, they are treated just as if they originated from an external MIDI device. Refer to the following diagram. There are three Initial Controller Amount screens (A-D, E-H, I-L).

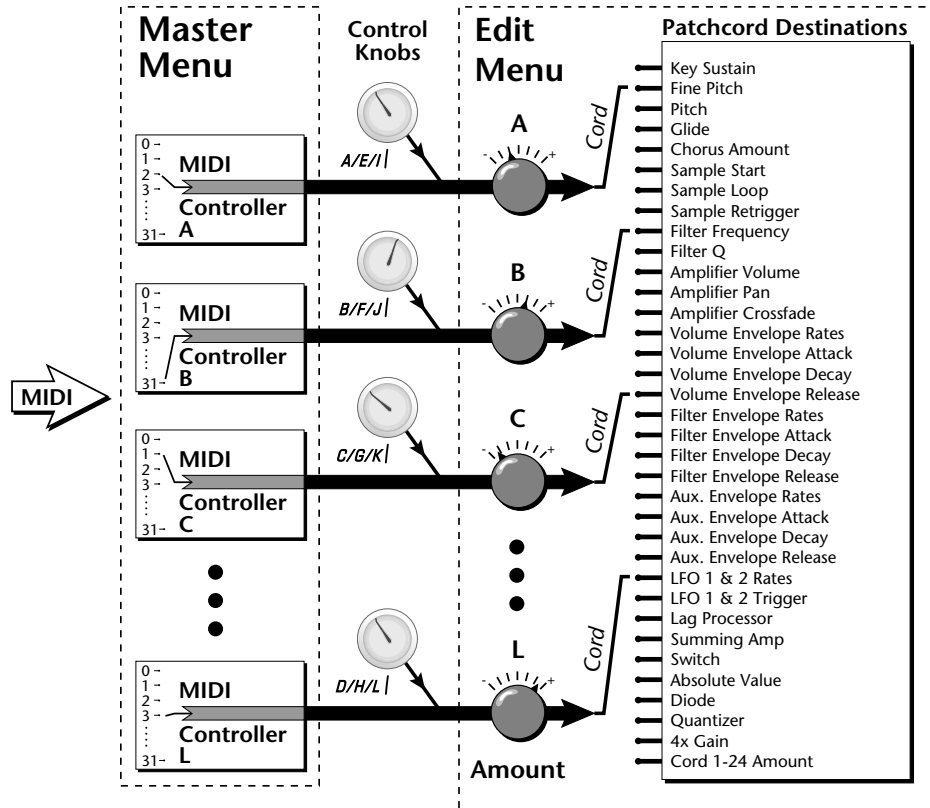

External MIDI controller numbers are assigned to the Letters A-L in the Master menu. The Initial Controller Amount value is sent to the PatchCord destination when the Preset is first selected. If you move the Control Knob, then that value replaces the initial value. If MIDI controller data is received it will similarly replace the knob or initial setting.



The Initial controller amounts can be set from 000-127 or they can be turned Off. If set to Off, the current controller value is used when the preset is first selected. Setting the Initial Amount to "off" uses the values from the previously selected preset.

Keyboard Tuning

In addition to the standard equally divided octave tuning, Mo'Phatt contains twelve factory programmed tunings and 12 user-definable tunings. The Keyboard Tuning parameter selects which tuning is used by the current preset. The User Tuning tables are defined in the Master menu.

The factory Keyboard Tuning tables are described in the following table.

Tuning Tables	Description
Equal Temperament	Standard Western tuning (12 equally spaced notes per octave)
Just C	Just intonation. (Based on small interval ratios. Sweet and pure, non-beating intervals.)
Vallotti	Valotti & Young non-equal temperament. (Similar to 12 tone equal temperament. Each key has a different character for a given scale.)
19-Tone	19 tone equal temperament. (19 notes per octave. Difficult to play, but works well with a sequencer.)
Gamelan	5 tone Slendro and 7 tone Pelog. (Javanese. Pelog are white keys, Slendro are black keys. Exotic tunings of Gamelan flavor.
Just C2	Allows you to play the following chords in the key of C: C, E, F, G, A, B, C#m, D#m, Em, F#m, G#m, Am, Bm
Just C-minor	Allows you to play the following chords in the key of C: C, E, F, G, A, B, Em, Am, Bm, C#m, D#m, G#m
Just C3	Allows you to play the following chords in the key of C: C, D, F, Bb, C#m, Dm, Em, F#m, G#m, Am
Werkmeister III	A "well" temperament developed in the 17th century. Although you can play in all keys, each key sounds slightly different.
Kirnberger	Another well temperament developed by Johann Philipp Kirnberger where no pitch is more than 12 cents off from equal temperament.
Scarlatti	A variant of Meantone tuning which was used from the 15th to 18th centuries.
Repeating Octave	Middle C octave is repeated up and down the keyboard. Link with a preset in equal temperament to form unusual inversion up and down the keyboard.
User 1-12	Define your own tuning tables (<i>Master menu</i>).

Refer to "User Key Tuning" on page 82 in the Master Menu chapter for instructions on how to define your own Keyboard Tunings.



Mo'Phatt implements the MIDI Tuning Dump protocol which allows you to create tuning tables on your personal computer and download them via MIDI. There are several computer applications available on the internet which let you create and download tuning tables via MIDI.

The Just C Tuning Tables

Well Tempered and Just were standard keyboard tunings up until the 20th-century when the current "equal tempered" scale became prevalent. In an equal tempered scale, the octave is equally divided into 12 parts. In Just or Well Tempered scales, the 12 notes are separately tuned to produce pure chords. However, in Just tunings you are limited to playing certain chords and if you play the wrong chord it may sound very BAD!

Mo'Phatt allows you to modulate between keys by providing you 12 user tuning tables. Tuning tables can be changed as you play using a program change (create several presets with the same sound and different tuning tables), by MIDI SysEx command (using a programmable MIDI footswitch or other device), or using a continuous controller (link 2 presets and crossfade between them using a controller). The Just C2, Just C min, Just C3 Tuning Tables

These new tuning tables take the concept of just intonation a step beyond previous E-mu products. Fully explaining the mysteries of just intonation is beyond the scope of this manual, but the subject is covered exhaustively in Hermann Helmholtz's On the Sensations of Tone, available at most libraries and bookstores.

The new tables are called Just C2, Just C3, and Just C Minor. Try playing in the key of C/Cm using each table. You'll quickly discover both the wonders and the frustrations of just intonation! In Just C, for example, you'll find that the chords C, Em, F, G, and Am sound beautiful. If you hold one of these chords, you'll hear no "beating". After playing for a few minutes, switch back to Equal Temperament for a rude awakening!

At this point you might wonder why anyone would use Equal Temperament to begin with. For the answer to that question, play a D, Dmi, or Bb chord!.The intervallic ratios that make the C & G chords sound so pure make the D chord sound horribly out of tune. That's why we had to include Just C3. In this tuning, D, Dmi and Bb sound in tune, but the G chord will sound wrong.

Each of the 4 tables allows you to play a different group of common chords in just intonation. Sadly, there is no single 12 note tuning that will allow all of the common chords to be in tune, and of course that's why they invented the equal temperament tuning system that we use today.

Just C

Play these chords: C, E, F, G, A, Cm, C#m, Em, F#m, Gm, Am

Just C2

Play these chords: C, E, F, G, A, B, C#m, D#m, Em, G#m, Am, Bm

Just C2 minor

Play these chords: C, D^b, D, E^b, G, A^b, Cm, Em, Fm, Gm

Just C3

Play these chords: C, D, F, B^b, C#m, Dm, Em, F#m, G#m, Am

Preset Links

You can link presets to other presets to create layering or keyboard splits. The current preset can be linked with up to two other presets (Links 1 & 2). Each linked preset can be assigned to a specific range in order to create keyboard splits or can be assigned a velocity range to switch links according to key velocity. In addition, you can specify Volume, Pan, Transpose and Delay settings for each Link. The modulation parameters specified in each preset remain in effect for each preset in the link.

LINK 1 Preset	PHATT
000 ² Preset Name	

LINK 1	KEY	VEL
RANGE	C-2 G8	000-127

LINK 1	VOLUME	PAN
	+0dB	00

LINK 1	TRANSPOSE	DELAY
	+00	0

Links provide an easy way to create new sounds by combining the existing presets. Or, you can create your own custom stacked presets with up to 12 layers! We're talking LARGE sounds here. Of course Links can also be used when you just want to stack up two sounds.

As an example, let's stack two presets to create a big sound. Start with a preset you like, then go into the Links screen and start scrolling through the preset list while you play to hear both presets together. When you find a winner, simply Save the preset and you're finished!

- You can "Split" the keyboard up to 12 ways by using combinations of the Layers and Links.
- By adjusting the Velocity for the link, you can bring in the link by playing hard.
- Transposing the Link can radically change the sound.
- The delay parameter lets you create surprise effects, echoes or cascades of sound as you continue to hold the keys.

Preset Tempo Offset

 For more information, see "Base Tempo (Master Clock)" on page 36.

This function allows you to double or halve the Base Tempo as it applies to this preset. When playing or sequencing several presets in Multimode, the Base Tempo may be too fast or slow for one preset. Using this feature, you can adjust the tempo for the misbehaving preset. The Tempo Offset can use the **current tempo** or be set to **half** or **twice** the current tempo.

TEMPO OFFSET
use current tempo x 2

Audition Riff Selection

 Listening to the Riffs is a quick way to learn the sounds in Mo'Phatt. If a preset has hidden tricks or controllers, these will be shown off in the Riff.

A Riff is a short pre-recorded musical phrase which can be anything from a single note to a full 16-track sequence as in the BEATS (bts) Riffs. This function allows you to assign a Riff to a Preset. The Preset Riff will be used when the front panel Audition button is pressed or when BEATS mode is set either to "On" or "Omni" in the main preset selection screen.

The Riffs themselves cannot be modified.

AUDITION SELECTION
Plays:KEY-MiddleC

Play Solo Layers

When constructing multilayer sounds it is often useful to turn off one or more of the layers so you can hear what you're doing! This feature allows you to temporarily solo individual layers or listen to them in any combination. This screen differs from the other Edit screens in that it is NOT saved with the preset. The values reset each time you exit the Edit menu.

Solo is activated by setting any layer to On (On = the layer is being Soloed). Any layers set to **On will play** and any layers set to **Off will be muted**. If all layers are set to Off, then Solo mode ends and all layers play normally. When you exit the Edit menu, all layers play normally.

PLAY SOLO LAYERS
1: off 2: off 3: off 4: off

Programming Tutorial

Editing Presets

Changing the Instrument

There is so much you can do with the Mo'Phatt it's impossible to describe it all. This chapter is will give you some ideas for programming your own custom sounds and contains step-by-step instructions to help you get started. In order to get the most from this chapter, we recommend you actually try each example. Have fun!

One of the easiest ways to make a new preset is to edit an existing preset. This is also an excellent way of becoming familiar with Mo'Phatt. If you don't like what you hear, simply select a new preset, then Mo'Phatt reverts to the original sound. Changes are not permanent until you Save them (see "Saving a Preset" on page 183).

Let's experiment and modify a few parameters of an existing preset. We'll start with functions that have an obvious effect on the sound: Instrument Select, Tuning, and Chorus.

Changing the instrument is the easiest and most dramatic way to modify an existing preset.

► To Change the Instrument for the Current Layer

1. Choose any cool preset, then press the Edit button.
2. Scroll through the Edit menu until you come to the Instrument page.



3. Move the cursor down to the bottom line (using a Cursor button).
4. Use the Data Entry Control to change the instrument. This changes the instrument for the current layer (in this case it's L1).
5. Play the keyboard as you scroll through the various instruments.

Changing the Tuning of an Instrument

► To Change the Instrument for any Layer in the Preset

6. Move the cursor back up to the first field in the first line (the layer).
7. Use the Data Entry Control to select the layer you want.



8. Repeat steps 3 and 4 for each selected layer. Find an instrument that sounds good when combined with the previous instruments selected.

With all these great instruments to work with, you really can't go wrong. Now let's play with the tuning.

Tuning the selected layer of the preset changes the pitch of the key on the controller. If the numbers are "00," it means that the instruments are tuned to concert pitch (A=440 Hz). The Coarse tuning value represents whole semitone intervals. The Fine tuning value shifts the pitch in 1/64 semitones (or 1.56 cents).

► To Tune the Instrument of the Current Layer

1. Scroll through the Edit menu until you come to the Tuning page.

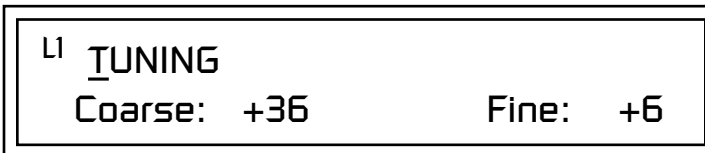

2. Move the cursor to the Coarse field (using the cursor button).
3. Set the value to +12 to shift the pitch up a whole octave. To shift the pitch in smaller units than a semitone, use the Fine field.

Try tuning one of the instruments to a perfect fifth above the other by setting the Coarse value to +7.

Tuning an instrument far out of its normal range completely changes the character of the sound. For example, if you tune a bass guitar up 2 octaves, it's going to sound rather petite. On the other hand, if you tune it down 2 octaves, you can probably rattle plaster off the walls! Experiment with radical pitch shifting. You'll be surprised at the results.

Chorus



WARNING: Since it works by doubling the instruments, Chorus halves the number of notes you can play on Mo'Phatt.

This is an easy one. Chorus works by doubling the instruments and detuning them slightly. The larger the chorus value, the more detuning occurs. The Width parameter controls the stereo spread. A Width value of 0% reduces the chorus to mono, a value of 100% provides the most stereo separation. Chorus is useful when you want to “fatten up” a part quickly and easily.

► To Chorus a Layer

1. With the cursor on the top line of the display, turn the Data Entry Control until you find the Chorus page.
2. Use the cursor buttons to advance the cursor to the Chorus field (the first field in the bottom line of the display). Use the Data Entry Control to turn on chorus.

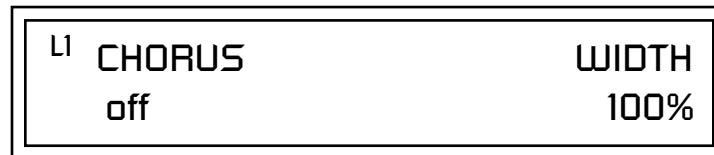

3. Select a Width value based on the amount of detuning you want. Smaller numbers mean less detuning, larger ones more.

You can select various amounts of chorusing for each of the instruments, just play around with the Chorus and Width parameter until you like what you hear.

Volume Envelope

Every sound you hear, whether it's a piano note, a drum, or a bell, has a characteristic volume curve or envelope. This Volume Envelope shapes the volume of the sound which grows louder or softer in various ways during the course of the sound. The volume envelope of a sound is one of the clues our brain uses to determine what type of sound is being produced.

An envelope shapes the sound or volume of the sound over time. The envelope generators in Mo'Phatt all have six stages to the contour: Attack 1, Attack 2, Decay 1, Decay 2, Release 1 and Release 2. When you press a key on the keyboard, the envelope goes through each of the first four stages, advancing to the next stage when the defined Level for each is reached. As long as you continue to hold the key down, the envelope continues through the first four stages holding at the end of the Decay 2 level until the key is released. When you release the key, the envelope jumps to the Release stages (no matter where the envelope is when you release the key) ending at the Release 2 level.

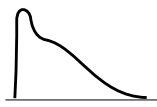

Piano

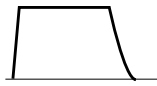

Organ



Strings

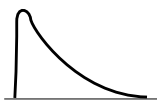

Percussion

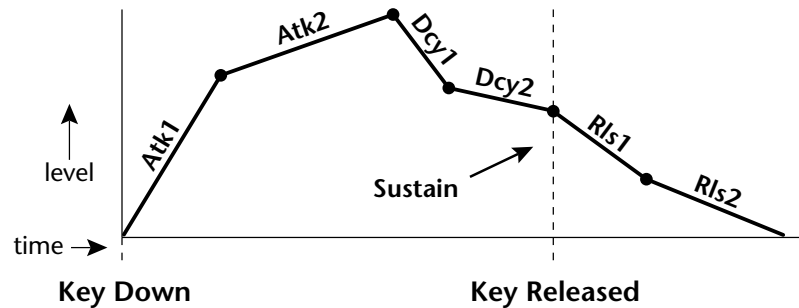

Every instrument in Mo'Phatt has its own predetermined volume envelope which is used when the Volume Envelope parameter is set to "factory." By setting the Volume Envelope to "time-based" or "tempo-based," we can reshape the instrument's natural volume envelope any way we want. By reshaping the volume envelope of an instrument, you can dramatically change the way the sound is perceived. For example, you can make "bowed" pianos or backward gongs. The diagrams to the left show the characteristic volume envelopes of a few common sounds.

In preparation for this experiment choose almost any of the standard organ presets which continues to sustain when the key is held down. Go to the Instrument page and set it to "None" on all layers except Layer 1. Now you're ready to play with the Volume Envelope.

► To Setup the Volume Envelope

1. Go to the Volume Envelope mode screen and set the Volume Envelope mode to "time-based."

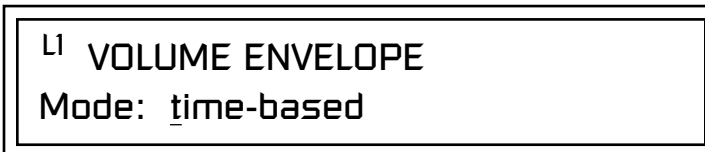

2. Now move on to the next screen to set the Volume Envelope parameters.

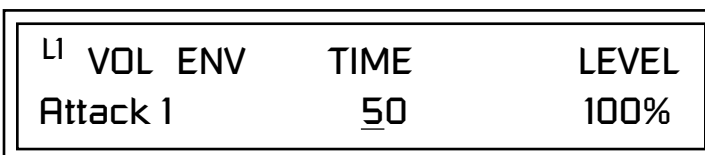

3. Increase the Attack 1 time value and play a note. The attack controls the time it takes for the sound to reach the Attack level when a key is pressed and held.

Working with Filters

4. Move the cursor to the first field in the bottom line and use the cursor buttons to advance to the Release pages.
5. Increase the Release 1 and 2 times. Note the effect as you release the key on the controller. The Release stages controls the time it takes for the sound to die away when a note is released.

The filters make it possible to remove certain components of the sound. A low pass filter removes the high frequency components or put another way, it “lets the low frequencies pass.” A high-pass filter removes the low frequency components from the sound letting only the high frequencies pass. See “Mo’Phatt Filter Types” on page 133 for a complete list of Mo’Phatt’s filters and their descriptions.

In preparation for the next tutorial, select a preset from the “bas:” category.

1. Go to the Instrument screen (Edit menu) and scroll through the instruments until you find one with a harmonically rich sound. Since filters work by removing or accentuating certain frequencies, we want to make sure that we have a lot of frequencies to start with.
1. Advance to the Filter Type screen using the Data Entry Control. Select the Classic 4th order filter.

L1	FILTER	Ord	Type
	Classic	4	LPF

2. Go to the Filter Frequency and Q screen. Position the cursor in the Freq: field as shown in the following illustration.

L1	FILTER	
Freq:	255	Q: 000

The Frequency parameter determines the filter cutoff frequency or the frequency the filter uses as the highest frequency allowed to pass.

If you play the keyboard now, you should hear the raw Looped Perc 1 sound. Slowly decrease the filter cutoff frequency value as you play the keyboard. The sound gets more and more dull as you remove more and more high frequencies from the sound. At some point, the sound completely disappears. (You have filtered out everything.) The chart on the following page illustrates what you just did.

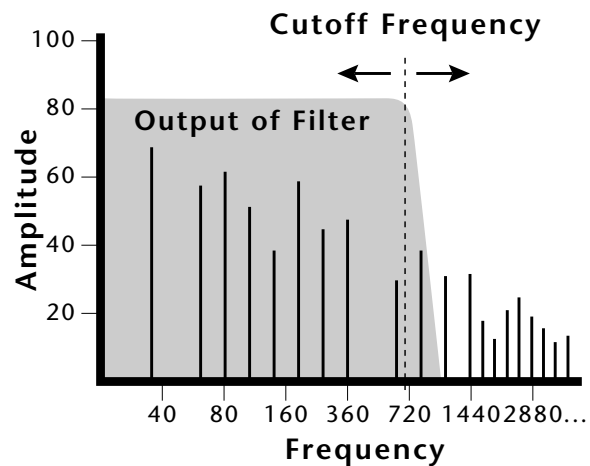

3. Open the filter back up to 255, then move the cursor to the Q field.
4. Set the Q to 10, then move the cursor back under the Freq value. As you change the frequency, notice that the sound now has a sharp, nasal quality. A high Q boosts or amplifies the frequencies at the cutoff frequency (Fc).
5. Reset the cutoff frequency to the lowest setting (0.08Hz) and the Q to 00.

Adding the Filter Envelope

Now let's modulate the Filter Frequency with the Filter Envelope. The Filter Envelope is a device that can automatically change the filter frequency during the course of the note. Before we define the Filter Envelope, we need to patch the Filter Envelope to the Filter Frequency.

► To Setup the Filter Envelope

1. Go to the PatchCord screen.

L1 PATCHCORD	#01
R1sVel -> AmpVol	+100

2. Move the cursor below the first field in the bottom line of the display. This is the Source field. Use the Data Entry Control to change the Source to "FiltEnv" as shown in the following illustration.
3. Advance the cursor to the next field. This is the Destination field. Use the Data Entry Control to change the destination to "FiltFreq."

4. Move the cursor to the last field in the line. This is the Amount field. The Amount field determines the amount of modulation applied. Set this value to "+100."

```

L1 PATCHCORD #01
  FiltEnv+ -> FiltFreq +100
  
```

This setup connects the Filter Envelope Generator to the Filter Cutoff as shown in the following diagram.

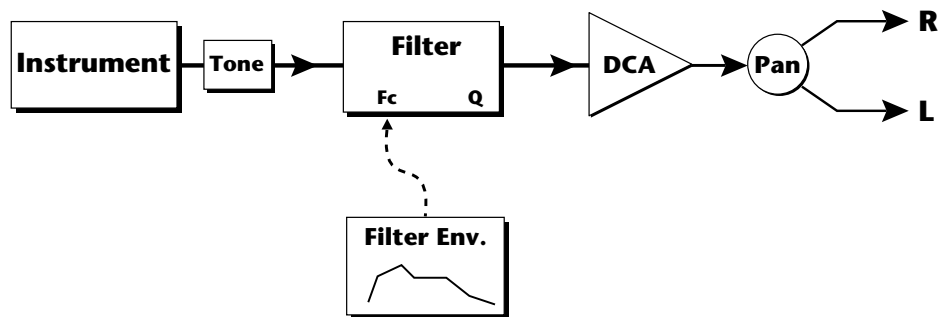

5. Now, return to the Filter Envelope Mode screen. Set the Mode to "time-based."

```

L1 FILTER ENVELOPE
  Mode: time-based
  
```

6. Advance to the Filter Envelope parameter page.

```

L1 FILT ENV      RATE      LEVEL
  Attack1       50        100%
  
```

7. Move the cursor underneath the time field and change the value to about +50. Now when you press a key the filter slowly sweeps up.

L1 FILT ENV	RATE	LEVEL
Attack1	50	+88%

8. Change the attack rate and note the change in the sound.
9. Set the envelope parameters as shown in the following table.

Envelope Phase	Time	Level %
Attack 1	40	65
Attack 2	65	100
Decay 1	80	85
Decay 2	25	50
Release 1	97	20
Release 2	73	0

With the above setup, the filter sweeps up, then Decays back down to the Decay 2 Level until you release the key. Then it sweeps down at the Release rates. Play with the envelope parameters for awhile to get a feel for their function. (If you're having trouble understanding the Envelope Generators, please refer to the Programming Basics section in this manual.)

Changing Filter Types

Go back to the Filter Type screen shown below and move the cursor down the lower line of the display. Change the filter type while playing the keyboard. There are 50 different filter types.

L1 FILTER	Ord	Type
Aah-Ay-Eeh	6	VOW

These filters are extremely powerful and have been carefully crafted to offer maximum flexibility and musical control. You may want to change the Envelope (PatchCord) Amount, Q and/or the Filter Frequency to get the right sound for each filter and instrument. These three controls, coupled with the Filter Envelope, are perhaps the most important controls on any synthesizer. Take the time to learn how they interact with each other and you will be able to create sounds beyond imagination.

Envelope Repeat

The Envelope Generator can also be made to repeat. When the envelope repeat function is On, the Attack (1&2) and Decay (1&2) stages will continue to repeat as long as the key is held.

► To Make the Filter Envelope Repeat:

1. Go to the Filter Envelope **Mode** screen shown below.
2. Move the cursor to the Mode field.



3. Turn the data entry control clockwise. The Mode field will change to Repeat as shown below.



4. Move the cursor to the on/off field and turn Envelope Repeat On.
5. Play a key on the keyboard. You should now hear the envelope repeating.
6. Go back to the envelope parameter page and adjust the Attack 1&2, and Decay 1&2 parameters. The repeating envelope cycles through these four stages as long as the key is held.

Practice Modulating

- Try modulating the pitch with the Filter Envelope generator
- Use Velocity to modulate the Filter Envelope PatchCord or the Filter Frequency. This brightens the sound as you play harder.
- Program the LFO to modulate Filter Frequency and Volume (Patch-Cord screen).
- Modulate the LFO with the other LFO, with Velocity, and with the Modulation Wheel.
- Examine the Factory presets to learn how they're constructed. There are lots of cool synthesis tricks you can use in your own presets.
- Think of ten of your own modulation routings, then try them out. The key to learning Mo'Phatt is to experiment.

Troubleshooting

A common source of confusion when working with the filter envelope is that the Attack or Release parameters might not seem to be working correctly. If you are not getting the expected result, try to analyze the situation. There will be many times when you will have to stop for a minute and think, "What am I trying to do and why isn't it working?" When this happens (and it will), don't panic. Troubleshooting is a normal part of the synthesis process. Simply examine the various parameters and try to be as analytical as possible as you solve the problem. The solution is usually simple (the filter is already wide open and can't open any more). Learning to play any instrument takes a little patience and practice.

Referring to the diagram below which shows the Mo'Phatt signal flow, notice that the DCA comes after the Filter. The DCA controls the final volume of the sound, so if the filter's release is longer than the release for the DCA, you won't hear it, because the DCA has already shut off the sound.

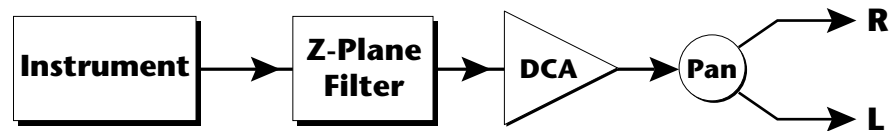

You're getting the general idea by now. Remember not to select a new preset before saving the current one or all your changes will be lost (the preset reverts to the last saved version). If you want to save your creation, select the Save/Copy menu and select a destination preset location for your masterpiece, then press Enter.

Because you can save your work, it's worth spending time to get the sound just right. When designing sounds you become an instrument builder as well as a musician. With Mo'Phatt you can design the custom radical instruments you've always wanted!

Linking Presets

 See "Preset Links" on page 155 for more information.

Using the Link pages in the Edit menu is a quick and easy way to create new sounds. Use the Links to "layer" presets and to "split" a keyboard into sections containing different sounds.

► To Layer Two Presets

1. Select the first preset you want to layer.
2. Press the Edit button. Use the Data Entry Control to move through the screens until you find either the "LINK 1" or "LINK 2" screen shown below.

LINK 1	PRESET	PHATT
off		

3. Move the cursor to the second line of the display. Select the preset you want to link with the preset you selected in step 1. Play the keyboard as you scroll through the various presets to hear the results.
4. If you want the link to be a permanent part of the preset, be sure to save the preset. Otherwise, simply change the preset to erase your work.

► To Create a Split Keyboard Using Links

1. Follow steps 1 through 4 above.
2. Press Enter and use the Data Entry Control to advance to the next page.

LINK 1	KEY	VEL
RANGE	C-2 B4	000 127

3. Set the keyboard range of the linked preset as desired.
4. Press Enter and use the Data Entry Control to go to the Key Range page (It's one of the first Edit menu pages).

L1	KEY:LO	FADE	HIGH	FADE
	C5	000	G8	000

5. Set the range of the original preset so it fills the remaining keyboard area. Save the preset.



Effects

Effects Overview

Mo'Phatt has two stereo effects processors. When playing presets one at a time, the two processors can be programmed as part of the preset. When the MIDI Mode is set to "multi," Mo'Phatt uses a global effects assignment (Master Effects). The diagram below shows how the effects are integrated into the signal path using a parallel effects send/return model, similar to a mixing console.

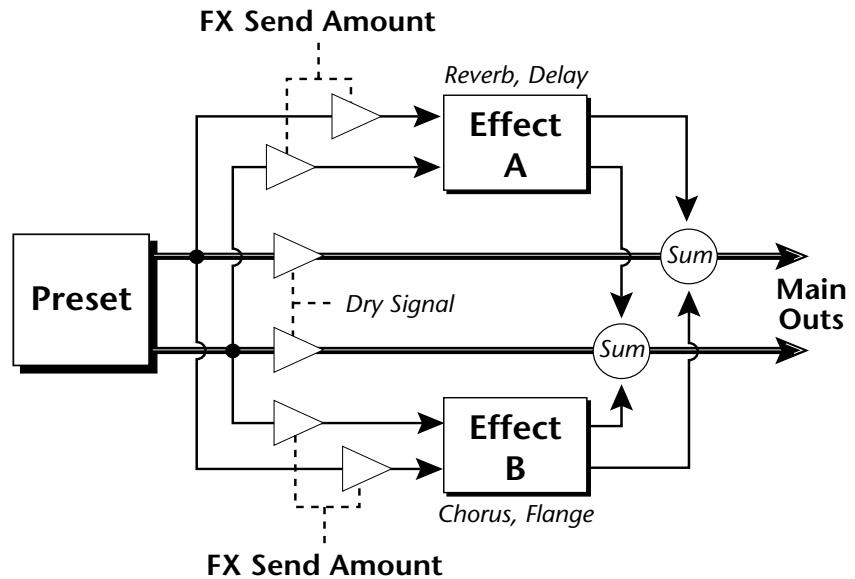

The Effects Sends

On a mixing console you can control the amount of signal each channel sends to the effect bus. This allows each channel to be placed in a slightly different "sonic space" which creates an airy, open sound.

Mo'Phatt uses this basic concept, but works in a slightly different manner. There are four effects busses: Send1-Send4. Each preset or each MIDI channel (you determine which), can be directed to one of the four busses. Each effect processor has four Send Amounts which allow you to set the wet/dry mix on each of the four busses going into the effect. A setting of 0% is completely dry (no effect). A setting of 50% contains an equal mix of affected and normal (dry) signal.

The Effects Send is programmed for each layer in the Edit menu. These routings can be overruled in the Master menu *Mix Output* screen by changing the submix setting from “preset”, which uses the preset routing, to Send1-Send4. In the diagram below, MIDI channel 1 is programmed to obey the preset routing which in this case is Send 1.

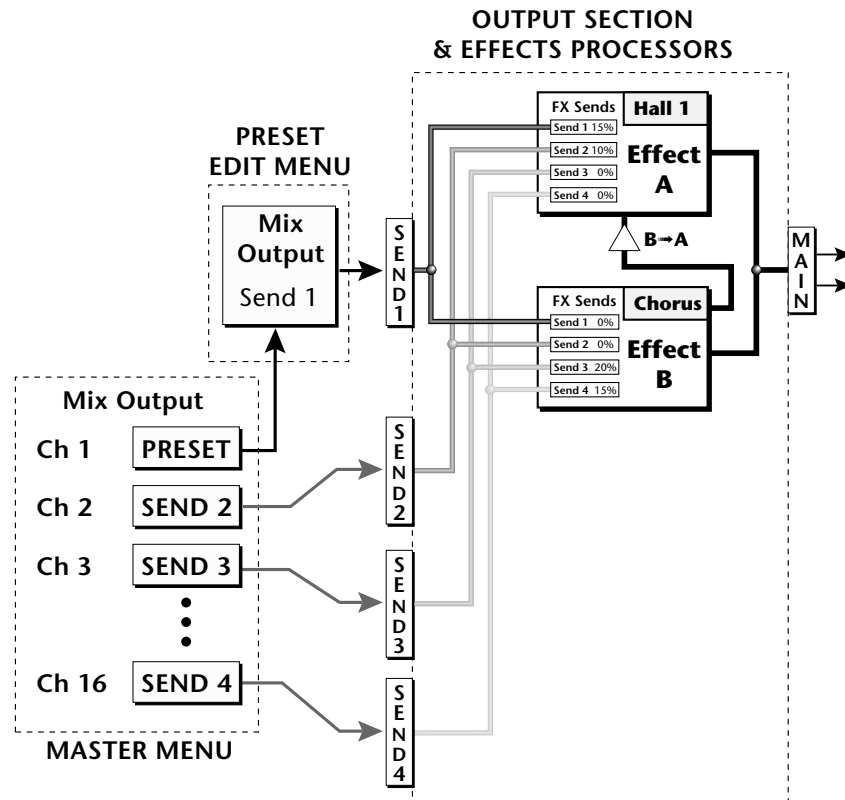

Individual layers or entire MIDI channels can be routed to any of the four busses.

The four Effect Sends allow you to get the most out of the two effect processors. For example, with Effect B set to an echo algorithm, you could route one MIDI channel to Send 3 and set the effect amount to 80%. Another MIDI channel could be routed to Send 4 with an effect amount of only 5%. This is almost like having two different effects!

The Mix Output function is also useful when sequencing since it lets you route specific MIDI channels (and thus sequencer tracks) to specific Sub outputs (on the back panel) where they can be processed with EQ or other outboard effects.

Effect Types

A Effect Types

Room 1-3
Hall 1 & 2
Plate
Delay
Panning Delay
Multitap 1
Multitap Pan
3 Tap
3 Tap Pan
Soft Room
Warm Room
Perfect Room
Tiled Room
Hard Plate
Warm Hall
Spacious Hall
Bright Hall
Bright Hall Pan
Bright Plate
BBall Court
Gymnasium
Cavern
Concert 9
Concert 10 Pan
Reverse Gate
Gate 2
Gate Pan
Concert 11

Medium Concert
Large Concert
Large Concert Pan
Canyon
DelayVerb 1-3
DelayVerb 4-5 Pan
DelayVerb 6-9

B Effect Types

Chorus 1-5
Doubling
Slapback
Flange 1-7
Big Chorus
Symphonic
Ensemble
Delay
Delay Stereo
Delay Stereo 2
Panning Delay
Delay Chorus
Pan Delay Chorus 1 & 2
Dual Tap 1/3
Dual Tap 1/4
Vibrato
Distortion 1 & 2
Distorted Flange
Distorted Chorus
Distorted Double

Effect Parameters

“A” Effect types contain Reverb and Delay effects. “B” Effect types contain Chorus, Flange and Distortion effects. There are 44 “A” effects and 32 “B” effects. In addition to the effect type, there are user adjustable parameters for each effect. The “A” effects have programmable Decay and High Frequency Damping. The “B” effects have user programmable Feedback, LFO Rate, and Delay Time.

Decay

The Decay parameter is used when setting “A” type effects. Decay sets the length of time it takes an effect to fade out. When setting up reverb effects, Decay controls the room size and the reflectivity of the room. For larger room sizes and greater reflectivity, set the Decay value higher. When setting up delay effects, the Decay parameter controls how many echoes are produced or how long the echoes last. The greater the value, the more echoes and longer lengths of time.

The Decay value range is from 0 through 90.

High Frequency Damping

The HF Damping parameter is used when setting “A” type effects. High Frequency energy tends to fade away first as a sound is dissipated in a room. the HF Damping parameter adjusts the amount of damping applied to the signal’s high frequency elements which, in turn, changes the characteristics of the room. Rooms with smooth, hard surfaces are more reflective and have less high frequency damping. Rooms filled with sound absorbing materials, such as curtains or people, have more high frequency damping.

The value range for High Frequency Damping is from 0 through 127.

Feedback

The Feedback parameter is used when setting “B” type effects. The Chorus and Flange effects have a controllable feedback loop after the delay element. Feeding back a small amount of the signal intensifies the effect by creating multiple cancellations or images. Higher feedback values increase the amount of the Feedback loop.

The Feedback value range is from 0 to 127.

LFO Rate

The LFO Rate parameter is used when setting “B” type effects. Both Chorus and Flange effects use a Low Frequency Oscillator (LFO) to animate the effect. LFO applied to a chorus effect creates the slight changes necessary for a realistic choral effect. Applied to a flanger effect, the LFO moves the comb filter notches and adds animation to the sound.

The LFO Rate value range is from 0 to 127.

Delay

Flanging, chorus and echoes are all based on a delay line where the signal is delayed by some time period and then mixed back with the unaltered signal. This parameter specifies the how much time passes before you hear the delayed signal. On some effects, this value cannot be changed. In this case, the field contains a dash.

The Delay value range is from 0ms to 635ms.

Effects Programmed in the Preset

Effects are normally programmed as part of the preset allowing you to have a different effect for each. This section describes how to program and modify Mo'Phatt's preset effects.

► To Program the Effects as Part of the Preset:

1. Press the Edit button. The LED illuminates and the Edit screen appears.
2. Use the Data Entry Control to select the FXA Algorithm screen.



3. Select an Effect. Do not select the "Master Effect" setting or the global effects set up in the Master menu will be used instead of the Preset Effect settings.
4. Use the Data Entry Control to select the FXA parameter screen.

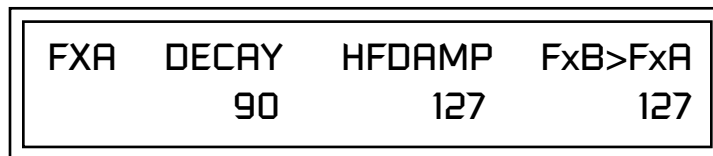

The FxB -> FxA parameter lets you route the B effect through the A effect. See "Effect B Into Effect A" on page 178.

5. Set the other effect parameters to your preference. Refer to the information in the last section for detailed descriptions of these parameters.
6. Use the Data Entry Control to select the FXB Algorithm screen.



7. Select an Effect. Do not select the "Master Effect" setting or the global effects set up in the Master menu will be used instead of the Preset Effect settings.
8. Use the Data Entry Control to select the FXB parameter screen.

Master Effects

FXB	FEEDBK	LFORATE	DELAY
	127	127	635ms

9. Set the other effect parameters to your preference. Refer to the information in the last section for detailed descriptions of these parameters.
10. Save the preset. The programmed effects setting will be saved along with the preset.

You might want the effects to be programmed on a global basis when in Omni or Poly modes. You could choose your favorite reverb, for example, and have it applied to any preset you select.

When playing single presets, the effects are normally programmed as part of the preset. In Multimode, the Master effects are used, since there are only two effect processors to serve 16 MIDI channels.

► To Program the Master Effects

1. Press the Master menu button. The LED illuminates and the Master screen appears.
2. Use the Data Entry Control to select the FXA Algorithm screen.

FXA ALGORITHM
Lg Concert Pan

3. Select an Effect.
4. Use the Data Entry Control to select the FXA parameter screen.

FXA	DECAY	HFDAMP	FxB>FxA
	90	127	127

The FxB -> FxA parameter lets you route the B effect through the A effect. See "Effect B Into Effect A" on page 178.

5. Set the other effect parameters to your preference. Refer to the information in the last section for detailed descriptions of these parameters.
6. Use the Data Entry Control to select the FXB Algorithm screen.



7. Select an Effect.
8. Use the Data Entry Control to select the FXB parameter screen.

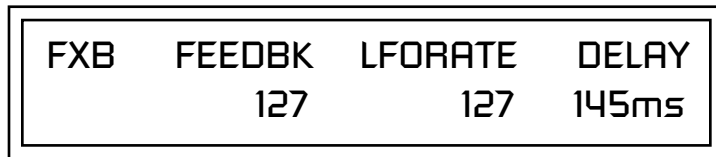

9. Set the other effect parameters to your preference. Refer to the information in the last section for detailed descriptions of these parameters.
10. Press the Edit menu button. The LED illuminates and the Edit menu displays the last screen used.
11. Use the Data Entry Control to access the FXA Algorithm page and select "Master Effect A."



The MIDI mode (Master Menu) must be set to Omni or Poly mode in order to select the effects in the preset.



12. Repeat step 11 for the FXB Algorithm
13. Save the preset. The Master effects routing will be saved along with the preset.

Effects Mode

This control provides a true bypass of the effects engine. Bypass is a useful feature if you are using external effects at the mixing console and want to turn the effects off for all presets.

► To Bypass the Effects:

1. Press the Master menu button. The LED lights and the last Master parameter screen used is displayed.
2. Use the Data Entry Control to select the Effects Mode screen.

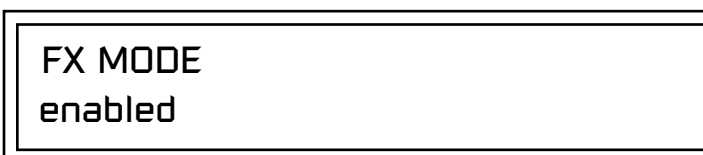

3. Use the cursor button to advance the cursor to the bottom line in the screen.
4. Use the Data Entry Control to change the value.
5. Press the Enter key to save the settings.

The Effects Mode values are “enabled” and “bypassed.” Enabling the Effects Mode turns on effects. Selecting “bypassed” turns off the effects.

Flexible Effects Control

The effects processor controls are very flexible. The effects can be controlled in three different ways to suit your personal preference and to adapt to different situations.

When in Omni or Poly mode, effects are normally programmed as part of the preset. In Multi mode, the two effects processors can be controlled using the Master settings or by using the effects settings of a preset on a specific MIDI channel. Effects can be programmed in the following ways:

 You can create special “Effects Presets” which are assigned to the FX Multi mode Control channel, then use standard MIDI Program Change commands to switch effects during sequence playback.

1. **Programmed as part of the preset when playing single presets (Omni or Poly Modes).**
2. **Programmed from the Master Effects Section when playing either single presets (preset Effect Type set to “Master”) or when in Multi Mode.**
3. **Programmed from the designated control preset when in Multi Mode.**

Refer to the following diagram for a look at how effects are programmed.

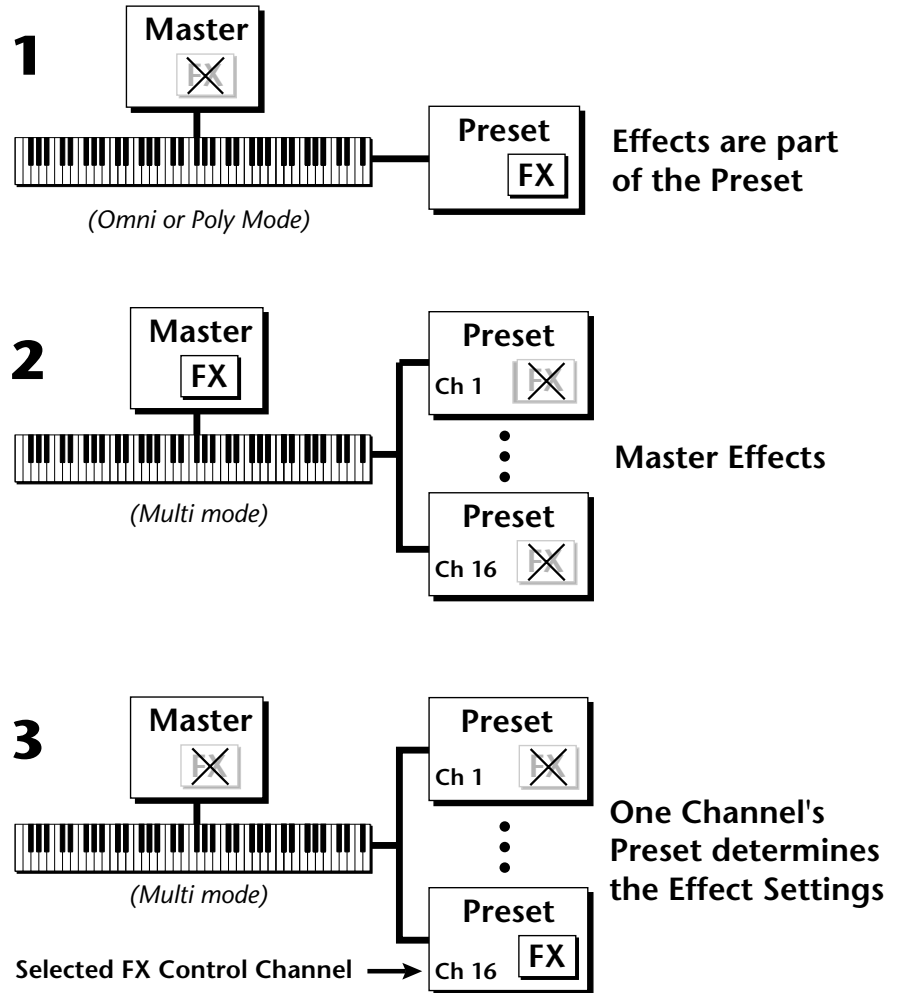

► **To Program the Effects Globally for all Presets in Multi Mode:**

1. Press the Master menu button. The LED illuminates and the Master menu screen appears.
2. Use the Data Entry Control to select the MIDI mode page. Choose "multi" for the mode.

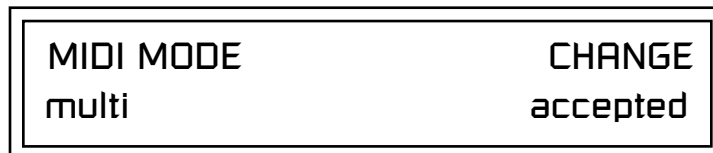

3. Move the cursor to the Multi mode Effects Control page using the Data Entry Control.



4. Set the Effect Control channel to *use master settings* using the Data Entry Control.
5. Press the Enter key to save the settings and return to the main screen.

Using the Effects Channel Settings in Multi Mode

In Multi mode, the two effects processors can be controlled from the Master Effects settings or they can follow the effects settings of the preset on a special MIDI channel. The effect settings on this special channel will be applied to all the other MIDI channels. This allows the effects to be changed during a sequence simply by changing the preset on a specified MIDI channel.

► To Program the Effects by Channel Number in Multi Mode

1. Press the Master menu button. The LED illuminates and the Master menu screen appears.
2. Use the Data Entry Control to select the MIDI mode page. Choose “multi” for the mode.
3. Move the cursor to the Multi mode Effects Control field using the Data Entry Control
4. Set the Effect Control to “preset on Channel #” (where # is replaced by the actual channel number from 1 through 16) using the Data Entry Control.
5. Press Enter to save the settings and return to the main screen.

Effect B Into Effect A

The output of effects processor B can be routed into effects processor A. This connects the effects in series instead of their normal parallel configuration. Two effects connected in series sound very different than the same two effects in parallel. For example, a chorus patched through reverb can turn a bland string section into a lush wall of sound. The B →A amount can also be controlled for even more flexibility.

► To Send the Output of Effect B through Effect A:

In this example, 100% of Effect B will be sent into Effect A.

1. Access the FXA parameter screen (in either the Master or Edit menus) that contains the FXB →FXA parameter.

FXA	DECAY	HFDAMP	FxB>FxA
	127	127	127

- Set this amount to 127. Press the cursor button to return the cursor to the top line in the display.
- Use the Data Entry Control to select the FXA submix routing parameter screen.

FXA SEND AMOUNTS	1: 10%
2: 20%	3: 30%
	4: 40%

- Press the cursor buttons to advance the cursor to the Main field.
- Set the Main send amount to any amount other than zero.
- Press the cursor button again to return the cursor to the FXA title. Use the Data Entry Control to advance to the FXB Algorithm page.
- Select an effect.
- Advance to the FXB submix routing page and set the Main FXB send percentage to zero.
- Play the keyboard and you should hear the B Effect running through Effect A. This patch is shown below.

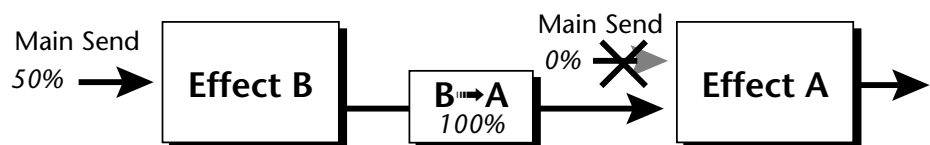

General Effect Descriptions

Reverb

Reverberation is a simulation of a natural space such as a room or hall. The reverb algorithms in Mo'Phatt simulate various halls, rooms and reverberation plates. In addition, there are several other reverb effects such as Gated Reverbs, Multi Tap (early reflections), Delay and Panning effects. There are two adjustable parameters on the reverb effects - Decay Time and High Frequency Damping.

Decay time defines the time it takes for the reflected sound from the room to decay or die away. The diagram below shows a generalized reverberation envelope.

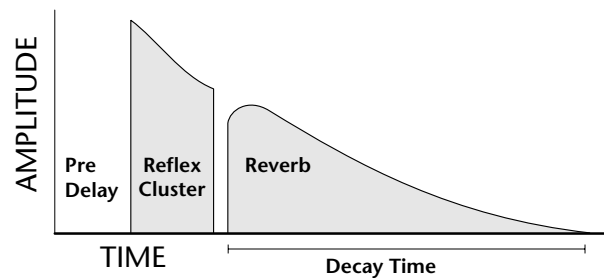

After an initial pre-delay period, the echoes from the closest walls or ceiling are heard. These first echoes, or the early reflection cluster, vary greatly depending on the type of room. Roughly 20 milliseconds after the early reflection cluster, the actual reverberation begins and decays according to the time set by the Decay Time parameter.

High frequency energy tends to fade away first as a sound is dissipated in a room. The High Frequency Damping parameter allows you adjust the amount of high frequency damping and thus change the characteristics of the room. Rooms with smooth, hard surfaces are more reflective and have less high frequency damping. Rooms filled with sound absorbing materials such as curtains or people have more high frequency damping.

General Descriptions of the Reverb Types

Room: Programs simulate small rooms with high frequency absorption caused by drapes and furniture.

Plates: Simulates plate type reverbs with their tight, dense, early reflections and sharp reverb buildup.

Hall: Presets recreate the open, spacious ambience of large concert halls.

Gated Reverbs: Add ambience only while the original signal is still sounding. As soon as the signal falls below a threshold, reverb is cut off.

Delay: Programs can be used to create echo and doubling effects.

Multi Tap: Programs consist of the reflection cluster only without the reverb decay.

Chorus

The function of a chorus device is to thicken the sound or to make one voice sound like many. This effect is usually created by mixing one or more delayed versions of the signal with the original. The delay times used are too short to be perceived as an echo, but long enough so that comb filtering does not occur. In addition, the delay time is varied via a low frequency oscillator to simulate the random differences which occur when multiple instruments are playing together. A slight amount of feedback improves the effect by creating multiple images of the sound as it recirculates again and again.

All the choruses are true stereo using two separate delay lines controlled by a single set of controls. The delay times are slightly different for each channel and the LFO phase is inverted on one channel to help contribute to the overall chorus effect. The LFO Rate and Depth settings are critical to achieving a realistic effect, with faster LFO rates generally requiring less LFO amount and vice-versa.

Doubling

When a copy of a sound delayed by about 26 milliseconds is added back to the original, two audio images are perceived by your brain. When the delayed image is slightly varied or modulated, the illusion of two voices is created.

Slapback

Slapback is a single short echo in the range of 50-60 milliseconds. A sound delayed by this length of time is perceived as a discrete and separate image which is useful for a thickening effect or as a pre-delay for reverb simulating a hard, reflective surface such a gymnasium wall.

Stereo Flanger

A flanger consists of a short audio delay line whose output is mixed together with the original signal. Mixing the delayed and original signals results in multiple frequency cancellations called a comb filter. Since the flanger is a type of filter, it works best with harmonically rich sounds.

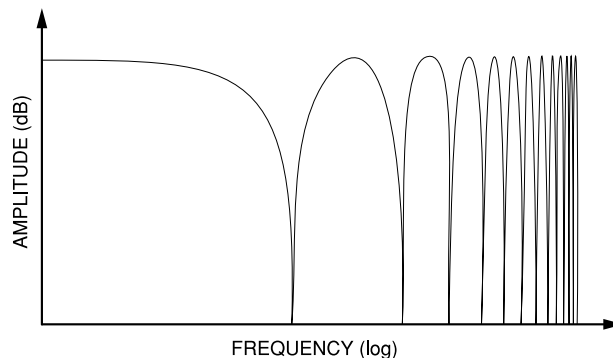

This is the frequency response of a Comb Filter.

Flanging was originally created using two tape recorders playing identical recordings. By exactly synchronizing the two decks and then slowing the speed of one by grasping the tape reel flanges, the flanging effect was born.

The Mo'Phatt flanger is a stereo device consisting of two separate delay lines controlled by a single set of controls. A Low Frequency Oscillator (LFO) varies this initial delay setting, changing the frequency of the notches and adding animation to the sound. LFO Rate controls the rate of change and LFO Depth controls how much the LFO changes the delay.

The Feedback control sends some of the delayed signal through the delay line again. When feedback is used the comb filter notches are deepened.

Delay

Delay is an effect which can be used for doubling, reverb pre-delay, or echoes.

Delay Time is variable from 0-635 mS and controls the time between echoes. Feedback and determines how long the echoes continue sounding. "Infinite" delay effects are also possible without the risk of runaway.

Stereo Delay

Similar to delay except that the delay line outputs a stereo signal from the mono input. The two output signals are a few milliseconds apart to create a stereo image. The delay times are variable from 0-635 mS.

Panning Delay

A panning delay is similar to the normal delay lines except that the echoes bounce back and forth between the two stereo speakers.

Dual Tap

These are delay lines where the signal is "tapped off" at two unevenly spaced locations. When feedback is used, multiple complex echoes are produced. The fraction in some of the algorithm names (i.e. 1/3, 1/4) refers to the time ratio between the taps.

Vibrato

Basically, this a delay line modulated by an LFO, but with none of the original signal added in. The LFO modulation creates a Doppler shift and a resultant cyclical pitch shift. The vibrato created in this manner sounds very different than vibrato created by frequency modulating the sample.

Distortion

Distortion uses a technique called "soft-clipping" to create additional harmonics in the signal. As the level increases, the top of the waveform becomes somewhat squared. As the level increases further, it transforms into a true square wave.



Soft clipping gradually squares the edges of the waveform as the amplitude is increased.

Save/Copy Menu

Saving a Preset

 Each time you change a preset parameter, the Save/Copy button LED illuminates reminding you to save your work.

The Save/Copy menu is used to save changes to a preset and to copy data between presets. When in “Quick Edit” mode, this menu always defaults to the “Save to Preset” page of this menu with the cursor on the second line. You can use the Data Entry Control to navigate to other pages that support copying information.

Any time you make a change to a preset, either using the Edit menu or by changing the Controller Knobs in Quick Edit mode, you must save the preset in order for the change to become permanent. When you save a preset it erases any existing preset information in that location. Make sure that the destination location does not contain preset information you want to keep.



SAVE PRESET to User
020¹ Destination Preset

► To Save a Preset

1. Press the Save/Copy menu button.
2. Scroll to the Save Preset screen using the data entry control.
3. Move the cursor to the bottom line on the display.
4. Select the new preset location using the Data Entry Control.
5. Press the Enter/Home button.

Copying Information

Copy Preset

The Copy operations let you copy information from any preset or layer to any other preset or layer. To use the copy command, first select the preset or layer to which you want to copy (the destination location). Then, from the copy screen, select the preset or layer you want to copy to the currently selected location (the source location). Using the copy commands you can copy preset, layer, PatchCord and arpeggiator information.

The Copy Preset command lets you copy all of the preset information from one location into the preset of the current location. The preset information in the source location (the preset location from which you want to copy) is not deleted from the original location, just copied to the destination location.

COPY PRESET from PHATT
009³ pad: Dreamer

 All the Sound Navigator features work when using the Copy functions.

► To Copy a Preset

1. Select the Preset you want to copy information *into*.
2. Press the Save/Copy menu button.
3. Scroll to the Copy Preset screen using the data entry control.
4. Select “Copy Preset from” using the Data Entry Control.
5. Select the preset you want to copy using the Data Entry Control. The ROM Bank, Preset Number, Bank Number, Category and Preset Name fields are all selectable.
6. Press the Enter/Home button.
7. A warning screen appears asking you to confirm once more. Press the Enter/Home button to copy the selected preset into the current location.

Copy Layer

The Copy Layer command lets you copy any layer information from one preset into any layer of the current preset location. The layer information in the source location (the layer location from which you want to copy) is not deleted from the original location, just copied to the destination location.

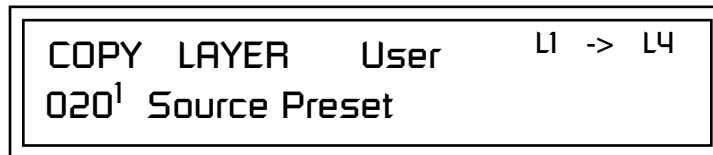

► To Copy a Layer

1. Select the Preset and Layer you want to copy information into.
2. Press the Save/Copy menu button.
3. Scroll to the Copy Layer screen using the data entry control.
4. Move the cursor to the bottom line on the display.
5. Select the preset location using the Data Entry Control, of the preset containing the information you want to copy into the current preset.
6. Move the cursor to the top line in the display.
7. Select the layer of the source preset in the first field on the right.
8. Select the destination layer in the second field.
9. Press the Enter/Home button.

Copy PatchCords

The Copy PatchCord command lets you copy the patchcord settings from one layer of the preset location into the current layer of the current preset location. The preset information in the source location (the preset location from which you want to copy) is not deleted from the original location, just copied to the destination location.

```
COPY CORDS   User   L1 -> L4
0201 Source Preset
```

► To Copy a PatchCord

1. Select the Preset and Layer you want to copy information into.
2. Press the Save/Copy menu button.
3. Scroll to the Copy Cords screen using the data entry control.
4. Move the cursor to the bottom line on the display.
5. Select the preset location using the Data Entry Control, of the preset containing the information you want to copy into the current preset.
6. Move the cursor to the top line in the display.
7. Select the layer of the source preset in the first field on the right.
8. Select the destination layer in the second field.
9. Press the Enter/Home button.

Copy Preset PatchCords

The Copy Preset PatchCord command lets you copy the preset patchcord settings from one preset location into the current preset location. The preset information in the source location (the preset location from which you want to copy) is not deleted from the original location, just copied to the destination location.

```
COPY PRESET CORDS   User
0201 Source Preset
```

► To Copy a Preset PatchCord

1. Select the Preset you want to copy information into.
2. Press the Save/Copy menu button.
3. Scroll to the Copy Preset Cords screen using the data entry control.
4. Move the cursor to the bottom line on the display.
5. Select the preset containing the information you want to copy.
6. Press the Enter/Home button.

Copy Arpeggiator Settings

This function lets you copy the Arpeggiator settings from any ROM or RAM preset location into the current RAM (User) preset.

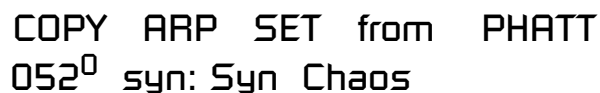

COPY ARP SET from PHATT
052⁰ syn: Syn Chaos

► To Copy the Arpeggiator Settings

1. From the main display, select the User Preset you want to copy the Arp setting *into*.
2. Press the Save/Copy menu button.
3. Scroll to the Copy Arp Set screen using the data entry control.
4. Move the cursor to any of the fields on the bottom line on the display.
5. Use the Data Entry Control to select the preset you want to copy *from*.
6. Press Enter when you have made your selection. *The Enter LED is flashing indicating that Mo'Phatt is waiting for your response.*
7. The Arp Settings are copied into the current preset.

Copy Arpeggiator Pattern

This function lets you copy the Arpeggiator pattern from any ROM or RAM preset to any RAM (user) pattern.



COPY ARP PAT from PHATT
96¹ TRANCED

► To Copy the Arpeggiator Pattern

1. Press the Save/Copy menu button.
2. Scroll to the Copy Arp Pat screen using the data entry control.
3. Move the cursor to any of the fields on the bottom line on the display.
4. Use the Data Entry Control to select the preset you want to copy *from*.
5. Press Enter when you have made your selection.



Overwrite pattern:
00⁰ No Control

6. Press Enter, The Arp Pattern is copied into the selected User Pattern.

Copy Preset Bank

The Copy Preset Bank command lets you copy an entire bank from any ROM or RAM bank location to any RAM (user) bank. This function can be especially useful after installing a new sound SIMM.

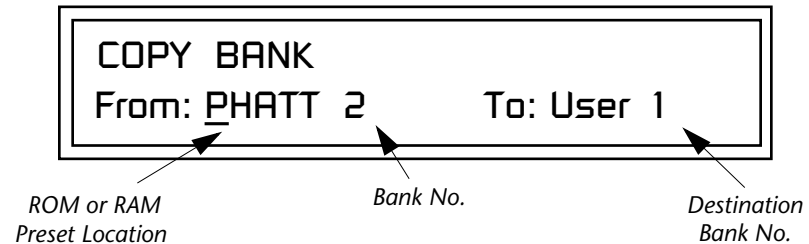

► To Copy a Preset Bank

1. Press the Save/Copy menu button.
2. Scroll to the Copy Preset bank screen using the data entry control.
3. Move the cursor to the "From" field on the bottom line on the display.
4. Use the Data Entry Control to select the preset bank you want to copy *from*.
5. Move the cursor to the "To" field on the bottom line on the display.
6. Use the Data Entry Control to select the User preset bank you want to copy *into*.
7. Press the Enter/Home button to overwrite the bank.

Multisetups

A Multisetup is a group of parameters that you might associate with a particular sequence or song. It is like a "snapshot" of the current MIDI channel configuration of the module. There are 64 setups numbered 0-63. All Multisetups are user programmable.

A Multisetup includes ALL the following parameters:

- Preset/Volume/Pan/Arp/Beats assignments for each of the 16 MIDI channels.
- Multisetup Name
- ALL Arp/BEATS Menu Parameters
- ALL Master Menu Parameters
except...
- MIDI Program Change->Preset map
- User Key Tuning Tables

Restoring Multisetups

Mo'Phatt contains 64 Multisetup locations. These are all User locations which you can use to store your own Multisetups.

Multisetups can also be restored using a MIDI Bank Select command. **Select: cc00 = 80, cc32 = 00, (dec)** then send a **Program Change** command corresponding to the Multisetup you wish to select.



► To Restore (Select) a Multisetup:

1. From the Save/Copy menu, scroll to the Restore Multisetup screen using the data entry control. The menu page most recently selected since powering up Mo'Phatt will be displayed. The cursor appears below the first character of the screen heading on line one.
2. Press either cursor button to move the cursor to the bottom line of the screen.
3. Now, use the Data Entry Control to select a Multisetup. The Enter LED will be flashing.
4. Press the Enter button to load the selected Multisetup.

Multisetup Name

Multisetups can be named to make it easier to remember their purpose.

1. Scroll to the "Setup Name" screen (shown below) using the Data Entry Control.

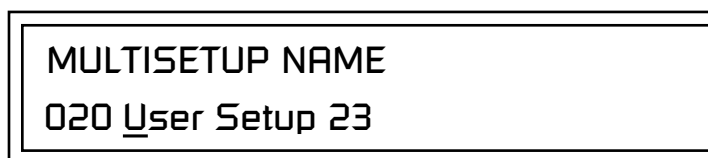

2. Press either cursor button to move the cursor to the bottom line of the screen.
3. Change the characters using the data entry control. Change the cursor position using the cursor buttons.
4. Press Enter or move the cursor to the top line when you're finished naming the multisetup.

Saving Multisetups

► To Save a Multisetup:

1. Set the Preset, Volume, Pan, Arp and Beats settings the way you want them for all channels. Set the Master menu parameters the way you want them.
2. Press the Save/Copy button, then scroll to the “Save Setup” screen (shown below) using the Data Entry Control.

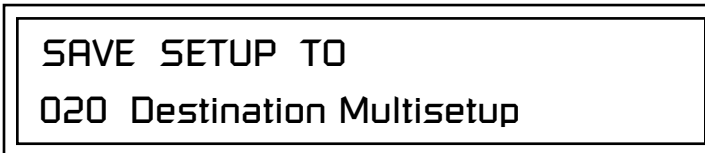

3. Press either cursor button to move the cursor to the bottom line of the screen.
4. Now, use the Data Entry Control to select the destination location. The Enter LED will be flashing.
5. Press the Enter button to save the Multisetup.

This is a great feature which creates a new preset using portions of the ROM presets as source material. By merging random presets, really great sounding presets can be generated with ease. Use this feature to generate wild new sounds, get new programming ideas or just for fun.

Create Random Preset



► To Create a Random Preset

1. Press the Save/Copy menu button.
2. Move the cursor to the bottom line on the display and press Enter.
3. A new random preset will be created.
4. Don't like the sound? Press Enter again and a new random sound will be generated.

 Examine interesting presets to learn how they work using the Edit menu.

Copy User Bank to Flash

This is a special purpose function to be used with the Flash sound authoring feature. Flash Sound SIMMs created on an EOS Ultra sampler can be used as a custom Mo'Phatt bank. Presets are then created in a User bank. When the bank of presets is finished, it can be copied, using this function, to the Flash SIMM. Flash SIMMs contain two separate memory locations. One of these memories contains the sound samples and the other memory can hold four banks of 128 presets.

WARNING: dangerous voltages are exposed inside Mo'Phatt! Make sure power is completely disconnected from Mo'Phatt before removing the top panel. Replace the top panel before restoring power to the unit. The two sound SIMM sockets in Mo'Phatt, marked 0 and 1, are located behind the controller knobs on the circuit board. **The destination Flash SIMM must be placed in SIMM socket 1.**

COPY USER BANK TO FLASH
From: User⁰ To: Flash²

► To Copy a User Bank to Flash

1. Make sure a Flash SIMM is inserted into the extra Mo'Phatt SIMM socket.
2. Press the Save/Copy menu button.
3. Rotate the Data Entry Control to select the "Copy User Bank" function shown above.
4. Move the cursor to the "From" field and select the User bank that you want to copy to the Flash SIMM.
5. Move the cursor to the "To" field and select the Flash bank that you want to contain the User bank.
6. Press Enter. The Enter LED will flash and the screen below appears.

**Press ENTER to Overwrite
Flash SIMM Presets**

7. Press Enter again to confirm. The following screen appears:

**COPYING USER BANK TO FLASH
Done. Please Reboot Now.**

8. The Flash presets cannot be used until Mo'Phatt is rebooted (power off then on). Reboot the Mo'Phatt and verify that the new Flash bank has been properly copied.



If there is no Flash SIMM in the unit, the error message, "Requires Flash SIMM" will be displayed.

Rename Flash SIMM



The Flash ID is the MSB of the MIDI Bank Select command used to select the Sound Bank.



If there is no Flash SIMM in the unit, the error message, "Requires Flash SIMM" will be displayed.

This utility allows you to rename the Flash SIMM and change its ID number. Flash SIMMs can have any five letter name you choose. Each Flash SIMM in a Mo'Phatt unit must have a unique ID number (106-119).

The field in the upper right corner selects between multiple Flash SIMMs. If only one Flash SIMM is installed, the field cannot be modified.

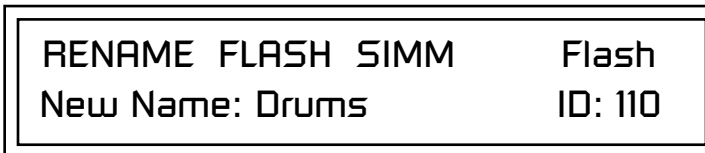

1. Make sure a Flash SIMM is inserted in a Mo'Phatt SIMM socket.
2. Press the Save/Copy menu button.
3. Rotate the Data Entry Control to select the "Rename Flash SIMM" function shown above.
4. Move the cursor to the "New Name" field and rename the SIMM using the Data Entry Control to select the letter and the cursor keys to select the position.
5. Set the Sound ID number for the SIMM. It doesn't matter which number you choose as long as the same number isn't used in another SIMM.
6. Press Enter. The following screen appears and the Enter LED will be flashing.

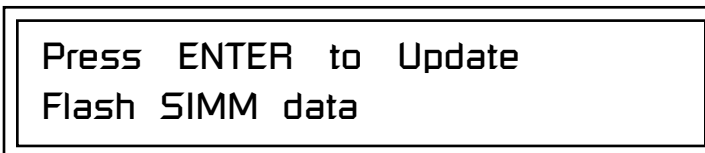

7. Press Enter again to confirm or any other button to abort. The following screen appears:

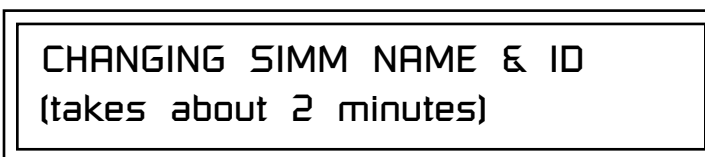

8. The Flash presets cannot be used until Mo'Phatt is rebooted (power off then on). Reboot the Mo'Phatt and verify that the new Flash bank has been properly renamed.

Duplicate Flash

This utility allows you to duplicate Flash SIMMs using Mo'Phatt. Both Sound and Preset data is copied when a Flash SIMM is duplicated. A factory sound SIMM cannot be copied using this utility.

WARNING: dangerous voltages are exposed inside Mo'Phatt! Make sure power is completely disconnected from Mo'Phatt before removing the top panel. Replace the top panel before restoring power to the unit.

The two sound SIMM sockets in Mo'Phatt are marked 0 and 1. These are located behind the controller knobs on the circuit board. The Flash SIMM you want to copy **MUST** be placed into SIMM Socket 0. The destination Flash SIMM must be placed in SIMM socket 1.

DUPLICATE SLOT 0 FLASH
Start



If there are no Flash SIMMs in the unit, or if the SIMMs are in the wrong slots, an error message will be displayed.

1. Make sure the two Flash SIMM are located in the required Mo'Phatt SIMM sockets.
2. Press the Save/Copy menu button.
3. Rotate the Data Entry Control to select the "Duplicate Flash SIMM" screen shown above.
4. Move the cursor to the bottom line and press Enter. The following screen appears and the Enter LED will be flashing.

Press ENTER to overwrite
the Flash SIMM in Slot 1

5. Press Enter again to confirm or any other button to abort. The following screen appears and the SIMM is copied.

DUPLICATING SLOT 0 -> SLOT 1
(Takes about 5 minutes)

6. When Mo'Phatt has finished duplicating the SIMM, turn power off, remove the copied SIMM, then reboot. That's it!



Appendix

Front Panel Knob Functions

 The Front Panel Knobs can be reprogrammed for each preset and stored in any of the User Presets. The functions shown here are the factory programmed settings.

This section provides some of the more technical information about Mo'Phatt. In this appendix, you will find information about velocity curves, MIDI commands and PatchCord charts.

The front panel knob functions are standardized for most of the factory presets. The typical functions of the controller knobs are described below. Match the controller knobs on your MIDI controller to the Realtime Controller Assignments in the Master menu to control these functions.

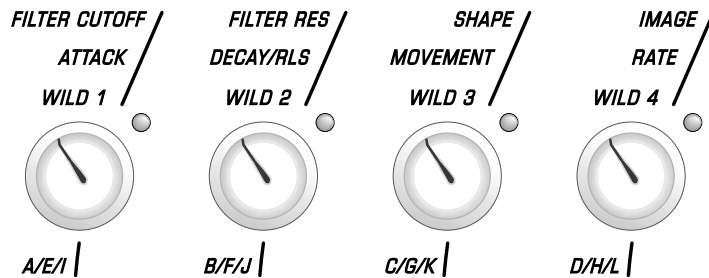

- Filter Cutoff** Filter Frequency
- Filter Res** Filter Resonance
- Shape** Volume or Filter Envelope Attack
- Image** Pitch/Glide/Chorus Amount/Layer Volume
- Attack** Volume Envelope Attack Rate
- Decay/Release** Volume Envelope Decay or Release Rate
- Movement** LFO Amount
- Rate** LFO Rate
- Wild 1** BEATS = Busy +/-, Non-BEATS = Filt Env Attack
- Wild 2** BEATS = Variation, Non-BEATS = Filt Env Release
- Wild 3** BEATS = Xpose Grp 1, Non-BEATS = Arp Velocity
- Wild 4** BEATS = Xpose Grp 4, Non-BEATS = Arp Gate

Presets

Preset Categories

The Mo'Phatt presets are organized in categories according to the types of sound. Listed below are the categories and their three letter prefixes:

amb: Ambient	arp: Arpeggiated
bas: Bases	bpm: Synchro-sonic, clocks
brs: Brass instrument	bts: BEATS presets
gtr: Guitar, acoustic or electric	hit: Short, powerful
key: Keyboard instrument, organ	kit: Drum kit
led: Leads	pad: Sustained, rich
rom: Plays thru multiple instruments in ROM	sfx: Sound Effects
str: Strings	syn: Synthesizer, harmonically rich
vox: Vocals	

Preset Listing

User Bank 0, PHATT Bank 0

- | | | |
|----------------------|----------------------|-----------------------|
| 0. bts:Becky Boise | 43. gtr:Linky Fingaz | 86. key:Tiny Wonders |
| 1. bts:The Ultimate | 44. str:Ooops! | 87. kit:Obsession |
| 2. bts:Iced Out | 45. pad:Nitrogen | 88. kit:Regal Gate |
| 3. bas:SubLevel | 46. str:Pizz Strings | 89. bas:Fretless |
| 4. gtr:Wah Getarrs | 47. bts:YeaYeaZ | 90. sfx:Sick Girl |
| 5. bts:MooshooClan | 48. arp:SupermanSaw | 91. sfx:KindaMuddy |
| 6. key:Chords&Hits | 49. key:Orgg Doggie | 92. syn:SPICEBOY:-) |
| 7. pad:Spirit Call | 50. syn:TinkerToyz | 93. syn:SuKaButt |
| 8. str:GothStrings | 51. pad:JP Layer | 94. str:Fade It |
| 9. bts:Hot n Steamy | 52. gtr:BedofFire | 95. hit:StrikeZAgain |
| 10. bts:8nt Urz | 53. key:Phat Klav | 96. syn:WeirdVox |
| 11. kit:Hive Jiver | 54. bts:Beat Prophet | 97. bas:Box O Bass |
| 12. syn:Plucky | 55. kit:Betta Beata | 98. bas:Poppy |
| 13. bas:Slap Pop | 56. led:AllJackedUp! | 99. pad:OuterLimits |
| 14. gtr:Sexy Slider | 57. sfx:SolarBaBies | 100. str:FakingIt |
| 15. pad:Cherubs | 58. syn:DeGlown | 101. str:Section |
| 16. bts:I Miss You | 59. bts:KattznJammah | 102. str:Pizz&Sct MW |
| 17. vox:theWatcher | 60. kit:MuSic2DrIvBy | 103. str:Nightmare |
| 18. key:SOOTCaSE'000 | 61. gtr:SyCoCry | 104. syn:SoftStuff |
| 19. led:Handwormed | 62. vox:All Talk | 105. kit:10HiHatMode |
| 20. sfx:WooleyBOB! | 63. bas:Digger Bass | 106. str:MistyStrng |
| 21. str:Sincerely | 64. gtr:Heavy | 107. pad:StringLayer |
| 22. syn:Synelead | 65. kit:Oh Yeah | 108. pad:HiQ Skwarez |
| 23. syn:Prof Brass | 66. kit:Jelly Belly | 109. amb:PeakinHard! |
| 24. gtr:HardCore | 67. syn:BoogieBAbY | 110. prc:Kix 1 |
| 25. bpm:Clockworx 1 | 68. kit:Cool Guy | 111. prc:Kix 2 |
| 26. gtr:General'sGtr | 69. kit:FriscoLayer | 112. prc:Snares 1 |
| 27. syn:SycoGirL | 70. bts:CreatrLayer | 113. prc:Snares 2 |
| 28. key:Klav Synth | 71. bts:I Miss You 2 | 114. prc:Snares 3 |
| 29. str:MadDramA \ | 72. bts:VideoGamez | 115. prc:Hats 1 |
| 30. hit:All 1 | 73. syn:WePhattField | 116. prc:Hats 2 |
| 31. gtr:NyLonArP | 74. syn:Ohoooo! | 117. prc:Cymbals |
| 32. gtr:Pinky Fingaz | 75. sfx:MarsattaksII | 118. prc:CongasBongos |
| 33. str:Harpo | 76. key:Sitar 88 | 119. prc:ClapsnSnaps |
| 34. pad:Synthetic | 77. vox:Agony Agony | 120. prc:Toms |
| 35. bas:YarsRevenge | 78. vox:Voicyst | 121. prc:Bells |
| 36. pad:Blades | 79. syn:WhY Me ? | 122. prc:Claves |
| 37. brs:SlapdatBrass | 80. vox:DadeezGAL:) | 123. amb:LiquidBatZ |
| 38. key:VINYL 73 | 81. amb:Underground | 124. prc:ShakeHerz |
| 39. key:FAR-FG-NUGEN | 82. bas:Rez Ripper | 125. amb:DeathLaughs |
| 40. syn:LadyOrgan1 | 83. pad:DeadMetal 1 | 126. prc:Misc |
| 41. pad:QuietTime | 84. key:Org De Borg | 127. led:I Saw Worms |
| 42. led:MonoGrunge | 85. key:Piano Jam | |

Preset Listing

User Bank 1, PHATT Bank 1

0. bts:TEMPLATE	43. sfx:DownTheDrain	86. bas:Fingered
1. syn:Auto Doom	44. arp:PhiltaSweepa	87. bas:Bagg
2. vox:Zeldas Fault	45. kit:09HiHatMode	88. bas:Distroy
3. pad:Darth Works	46. bas:SubSonicTri	89. bas:Blip
4. key:Harp Klav	47. brs:Brass+Tine	90. bas:Hecho Itter
5. key:Tine Split	48. sfx:YaYaYa	91. bas:Dubby
6. syn:VoxRoller	49. bas:Deeper	92. bas:Dubby 2
7. prc:Rainstick	50. bas:Acid	93. bas:Grit
8. prc:WhirlyBird	51. bas:BelowaWoofer	94. bas:Kraft
9. prc:Fills	52. bas:GutPunched	95. bas:Kraft 2
10. prc:Shakers	53. kit:WhatYouWant?	96. bas:Technoid
11. prc:Scratches	54. bas:It Too	97. key:PianoJam2
12. prc:SciFi Toy 1	55. brs:Lotsa	98. bas:Plucky
13. prc:SciFi Toy 2	56. bas:Fishy	99. bas:Harpbass
14. amb:PlezLemmeGo!	57. bas:SubOne	100. bas:Upright
15. gtr:Gener El	58. bts:Wide Hive	101. gtr:Crybabe 1
16. hit:All 2	59. bas:FuzzSubby	102. gtr:Wacka
17. prc:Thumb Piano	60. bas:SubTwo	103. gtr:Wacka Talkin
18. prc:Per Oct	61. bas:SubThree	104. gtr:Wacka Do
19. prc:PerOctLink	62. bas:SubFour	105. gtr:Chickn'1
20. gtr:NylonFantasy	63. bas:SubFive	106. gtr:Chickn'Dist
21. brs:Crunchy	64. bas:SubSix	107. gtr:Chickn'Slide
22. bts:Play Cousin	65. bas:Election	108. gtr:Exciteable
23. bas:SubVocoder	66. bas:Acid 2	109. gtr:Hen Drix
24. bts:ShakitZ	67. bas:Cradle	110. gtr:Lik Delay
25. bts:Girl Watcher	68. bas:Frogged	111. gtr:Lik Choppy
26. kit:TribeOMatic	69. bas:Babybass	112. gtr:Wackaloo
27. bas:Standin	70. bas:Soulfuzz	113. gtr:Willpy
28. str:Ballad Harp	71. bas:Speakeasy	114. gtr:Odlil
29. hit:DroppinOff	72. bas:BellyButton	115. gtr:YeWah
30. key:CityGiggin	73. bas:KeyOnate	116. gtr:Wah DisLik
31. brs:Philta	74. bas:Prophet	117. gtr:Wah Not
32. brs:Biggg	75. bas:Persistent	118. gtr:Wah Scale 4
33. gtr:WackaParty83	76. bas:Squared	119. gtr:Wah Scale 7
34. gtr:WackaParty2	77. bas:TheoryBass	120. gtr:Wah Upper
35. gtr:Wacka 96	78. bas:MarkOther	121. gtr:SpRinkel
36. gtr:Wacka 113	79. bas:Funk Pop 1	122. bas:Eat Me!
37. gtr:Wacka 3 83	80. bas:Funk Pop 2	123. syn:WapperFuzz
38. key:Crunch Klav	81. bas:Velo SlapPop	124. syn:Slippery
39. brs:Hitz	82. bas:Funky Finger	125. gtr:DirtyNoter
40. bas:Sonic Sine	83. bas:Funky Pik	126. kit:Happy'Z
41. vox:TB Eweew	84. bas:Funk Wave	127. str:Uni Strings
42. gtr:Cyclone	85. bas:Accidental	

Preset Listing

User Bank 2, PHATT Bank 2

- | | | |
|----------------------|----------------------|-----------------------|
| 0. gtr:Wah Walker | 43. syn:ReturnToZoo | 86. sfx:Syclear |
| 1. syn:Sin Symph 1 | 44. str:Disco Diva | 87. sfx:Reaper |
| 2. gtr:Mood | 45. pad:DanceLitez | 88. vox:Ahyeeyah |
| 3. gtr:Nylon | 46. gtr:Weeoww | 89. pad:Pulsar |
| 4. gtr:Nylon 2 | 47. led:RaveEEEE | 90. hit:Carney Hits |
| 5. gtr:Slide Hit | 48. led:RaveAAHH | 91. hit:Brazit 1 |
| 6. gtr:Fine Slide | 49. pad:AditivOrgan | 92. hit:Brazit 2 |
| 7. gtr:Grit Slide | 50. pad:Trans | 93. hit:Brazit 3 |
| 8. gtr:Strata | 51. pad:Narwhal | 94. hit:Brazit 4 |
| 9. gtr:Strum Glass | 52. amb:Trippin MW | 95. hit:Brazit 5 |
| 10. gtr:Flange Pick | 53. kit:WideOne | 96. hit:Spizy |
| 11. gtr:Grunge | 54. kit:ThugItUp | 97. pad:Worry |
| 12. gtr:One Shot | 55. kit:OnDaStreet | 98. str:Orchestsyn |
| 13. gtr:Slo Strum | 56. kit:The Wiz | 99. syn:Grinder |
| 14. gtr:Kraked Tube | 57. pad:KnobbyTwirly | 100. syn:Weeperr |
| 15. gtr:Burnt | 58. kit:PhilterFreak | 101. amb:Seascape |
| 16. gtr:Weezl Fuzz | 59. kit:Nu Funk | 102. sfx:Wet Trippy |
| 17. gtr:Slicer | 60. kit:Relapse | 103. syn:Two Step |
| 18. gtr:Dissed Hit | 61. kit:HardStep | 104. syn:Prosync |
| 19. gtr:Doom 1 | 62. rom:Play Thru | 105. kit:Mo Dist |
| 20. pad:Drone 1 | 63. hit:Sweetit | 106. kit:Slappy |
| 21. pad:Drone 2 | 64. hit:Knock U Out | 107. kit:DarkFlower |
| 22. pad:Drone Swirl | 65. hit:Nice Under | 108. kit:Funk 4 Life |
| 23. pad:Siren Spin | 66. hit:Splash | 109. kit:Perky |
| 24. pad:Leon's | 67. str:Suspence | 110. kit:Crunch |
| 25. hit:Guit n Hat | 68. key:Growl Drop | 111. kit:Klippy |
| 26. hit:Satisfying | 69. key:HarpsiFlange | 112. kit:GM Two |
| 27. hit:Org Creept | 70. str:HybridSweep | 113. kit:SubwayTunnel |
| 28. led:Deep Thought | 71. key:Kool Kord | 114. kit:ClasikStudio |
| 29. led:70's Lead | 72. key:Org Roll | 115. kit:ScratchHead |
| 30. led:Guitlet | 73. key:Perk Organ | 116. kit:FiltrSKRATCH |
| 31. syn:Synthomatic | 74. str:Synth String | 117. kit:Vilper |
| 32. pad:Transform | 75. key:Horror Glide | 118. kit:DubItUp |
| 33. amb:Droning MW | 76. brs:Caliente | 119. kit:NewBeat |
| 34. amb:Rubble MW | 77. brs:Trump Slide | 120. kit:CornaSto' |
| 35. bas:DropOffSine1 | 78. led:FantasyWormz | 121. sfx:BlowinUp1MW |
| 36. bas:DropOffSine2 | 79. bts:SpaceBoyZ | 122. prc:ScratchMatic |
| 37. key:So Kazual | 80. led:Yearning | 123. kit:Construction |
| 38. hit:Wheely Gal | 81. led:Reeder | 124. kit:NuMetal |
| 39. bas:DropOffSine3 | 82. led:Violetta | 125. bas:Cube Bass |
| 40. bas:DropOffSine4 | 83. led:Stevie | 126. bas:Iggio Basso |
| 41. key:Org Basic | 84. sfx:Mr.Clean | 127. syn:Objections |
| 42. key:Klav Mav | 85. sfx:Shield | |

Preset Listing

User Bank 3, PHATT Bank 3

- | | | |
|----------------------|----------------------|-----------------------|
| 0. vox:Dronodians C | 43. syn:WAWIFLHEAD | 86. led:Glue Tone |
| 1. bts:ItsUAgAIIn? | 44. vox:Voxcade | 87. kit:MarchMadnezZ |
| 2. kit:UainT@&#! | 45. key:MO 88 | 88. key:Tine Fuzzies |
| 3. bts:AllmyMoMees | 46. key:SOOTCaSE'300 | 89. gtr:Voyeur Trax |
| 4. bts:Glo BabieeS | 47. arp:Plop | 90. bts:Boombaa |
| 5. bts:Sistahoney | 48. key:Doodee | 91. bts:AstralTravel |
| 6. bts:IT'SLIKE Dat | 49. gtr:Gen X | 92. key:IntoTheLight |
| 7. str:StackedLegs | 50. key:KeyStoneE | 93. gtr:Psycho |
| 8. bts:Q BORO | 51. str:VIRGOE | 94. kit:7 HiHatMode |
| 9. vox:SingingTB | 52. vox:PretteeeeIII | 95. key:Tine Klav |
| 10. bts:My Girl YO | 53. arp:AgonyOrgon | 96. bts:Geechee GLO |
| 11. kit:RiDe E-Z | 54. vox:Sycoboy | 97. kit:WhatUstarted |
| 12. bts:DirTay drTee | 55. key:MO'E DAN | 98. kit:BabyDoll |
| 13. bts:MounTenbery | 56. key:StoneGroove | 99. bts:New WhirlOdr |
| 14. kit:SalsA Crunk | 57. key:WaThunk | 100. bts:Wile U Werk |
| 15. vox:FemmeDoTell | 58. vox:Vespers | 101. kit:U NO |
| 16. kit:Lesster | 59. gtr:SprinkleItOn | 102. bts:HeY ! |
| 17. key:NoMoreKlav | 60. kit:EasyRider | 103. kit:My Main Man |
| 18. bts:LAST CHANCE | 61. syn:WeirdVox2 | 104. bts:Can I Talk |
| 19. kit:A YO IIGHT | 62. kit:Stoopit | 105. bts:DJ GLO Jenkn |
| 20. kit:GOOD MU Sic | 63. syn:SilkWerm | 106. clk:Clockworx 2 |
| 21. syn:Sin Symph 2 | 64. syn:LadyOrgan2 | 107. prc:HiHatMono 1 |
| 22. bts:MALE BASHER | 65. amb:RaveSlave | 108. prc:HiHatMono 2 |
| 23. bts:DoitZ | 66. amb:MiseryMod | 109. key:Skini Klav |
| 24. kit:GuesWho'sBak | 67. kit:Young Luv | 110. prc:Bells Mono |
| 25. bts:U4 Got ME | 68. pad:TheMadSweep | 111. key:HipHopTines1 |
| 26. vox:Pretteeee.II | 69. kit:Woo Kid | 112. key:HipHopTines2 |
| 27. bts:Dr.Banner | 70. pad:JoVox | 113. vox:You |
| 28. rom:I Like U | 71. bas:Razza | 114. led:Screamer |
| 29. bts:SmoothoneZ | 72. led:RaveLine | 115. led:MonoBrass |
| 30. kit:TiME SquaRe | 73. led:SineWorm | 116. pad:Chasers MW |
| 31. bts:Oh BaebeeZ | 74. led:ProphetLine | 117. pad:LadyPulsar |
| 32. bts:GrungeZ | 75. bts:MO'HAPPYfeet | 118. pad:MeltingHartz |
| 33. bts:ClapYoHandZ | 76. amb:YouPhoned? | 119. arp:Low&Square |
| 34. bts:LaLaZ | 77. amb:PhonedAgain? | 120. vox:LetsDance |
| 35. bts:DialToneZ | 78. pad:OB Layer | 121. vox:Earth Lisa |
| 36. str:Sa-Spen Ful | 79. amb:VocodAhhh... | 122. gtr:Disturbed |
| 37. key:Perc Klav | 80. key:PhatttTines | 123. bts:DaPhattest |
| 38. key:SiMPeL | 81. bts:Luvline 1 | 124. bts:Sunrise |
| 39. sfx:theHitcher | 82. bts:Luvline 2 | 125. key:ReBeckTines |
| 40. key:Pretteeee... | 83. bts:Luvline 3 | 126. bts:Luv Joe'ns |
| 41. gtr:DaBradies | 84. key:CloudKeys | 127. :Default v1.0 |
| 42. amb:CosmicKlasik | 85. pad:Luxury | |

Instrument Listing

This section lists the raw instruments in the Mo'Phatt ROM set. Instruments consist of either multisamples or single samples.

0. :None	42. bas:Krafty 2	84. gtr:Wah Scale 2
1. bas:The Deepest	43. bas:Swing Hitter	85. gtr:Wah Scale 3
2. bas:Hummertime	44. bas:Technoid	86. gtr:Wah Scale 4
3. bas:WoofaWrekka	45. bas:Bender Hit	87. gtr:Wah Scale 5
4. bas:Hella Boom	46. bas:Synth Boom	88. gtr:Wah Scale 6
5. bas:Decision'99	47. bas:PluckySynth	89. gtr:Wah Scale 7
6. bas:Acid 1	48. bas:HarpOneShot1	90. gtr:Wah Scaler
7. bas:Acid 2	49. bas:HarpOneShot2	91. gtr:Wah Scaler 2
8. bas:Cradle	50. bas:HarpOneShot3	92. gtr:WahSurprised
9. bas:Frog Factory	51. bas:Upright One	93. gtr:Wah Upper
10. bas:Talk2MeBaby	52. bas:SP Stand-Up	94. gtr:Walk On Waka
11. bas:Soulified	53. bas:Bass Slide	95. gtr:Walker Wah
12. bas:Speakeasy	54. bas:FX F#0-B0	96. gtr:Wuckit
13. bas:Warm Welcome	55. gtr:All Wahs	97. gtr:Funky Likka
14. bas:Belly-Button	56. gtr:Crybaby Wah1	98. gtr:Squawk Hit
15. bas:KeyONate	57. gtr:Crybaby Wah2	99. gtr:Vinyl Mood
16. bas:TheOtherMarc	58. gtr:5strkchuck83	100. gtr:1 Note Mute
17. bas:Closer To It	59. gtr:Wow Wacka 83	101. gtr:RapNylonWave
18. bas:Fish Fry	60. gtr:WackaGruv283	102. gtr:R&B NylonWav
19. bas:Prophet	61. gtr:Wah Jan 83	103. gtr:EffectsD0-B0
20. bas:In Theory	62. gtr:Wacka 96bpm	104. gtr:Happy Strum
21. bas:Persistence	63. gtr:Wah 96 2	105. gtr:Sexy Slide 1
22. bas:Funk Pop 1	64. gtr:Wah 96 3	106. gtr:Sexy Slide 2
23. bas:Funk Pop2	65. gtr:CoolWaRif113	107. gtr:2StrokeStrum
24. bas:Funk Slap	66. gtr:WACKA Do 113	108. gtr:Fast Slider
25. bas:SlapPopSwtch	67. gtr:113 Wackaloo	109. gtr:Fine Slider
26. bas:Funk Finger	68. gtr:Wah Coming	110. gtr:Nln Strum Dn
27. bas:Funk Hollow	69. gtr:Chickenpickr	111. gtr:Gritty Slide
28. bas:Funk Pick	70. gtr:Chickjacked	112. gtr:Knock 1
29. bas:Funk Wave 1	71. gtr:Chucka Run	113. gtr:Knock 2
30. bas:Funk Wave 2	72. gtr:ExcitableWah	114. gtr:Squeak 1
31. bas:Accidental	73. gtr:Hendrix Wah	115. gtr:Squeak 2
32. bas:Finger Bass	74. gtr:LikethisLik	116. gtr:General Elec
33. bas:Bagg	75. gtr:Lil' Chopper	117. gtr:Strat 1 Shot
34. bas:Destroyer	76. gtr:Lil' Chukka	118. gtr:NotherElWave
35. bas:Blipp	77. gtr:Lil Wah Run	119. gtr:Dis One Notr
36. bas:Echo Hitter	78. gtr:Oddlilhitter	120. gtr:Funk Pop
37. bas:DubbyDoRite	79. gtr:Oh YEahWah	121. gtr:Pop 2
38. bas:Dub 2	80. gtr:Versa Wa	122. gtr:Chord Bed
39. bas:GrittyStanda	81. gtr:Wah LikDis	123. gtr:Krackly Kord
40. bas:Gritty Pulla	82. gtr:Wah Not?	124. gtr:Amp Noise
41. bas:Krafty 1	83. gtr:Wah Scale 1	125. gtr:Amp Ped

Instrument Listing

- | | | |
|-----------------------|-----------------------|-----------------------|
| 127. gtr:All Burners | 172. hit:Sweetness 1 | 217. brs:Stabber |
| 128. gtr:Hardcore | 173. hit:Sweetness 2 | 218. sfx:JungleWiggly |
| 129. gtr:Psycho Noise | 174. hit:QuirkyDrmBed | 219. sfx:Wet Tripper |
| 130. gtr:Fuzz Tone | 175. hit:Intro Beat | 220. hit:Dum Dum 1 |
| 131. gtr:Slicer | 176. hit:Knock U Out! | 221. hit:Dum Dum 2 |
| 132. gtr:Dissed Hit | 177. hit:Blip | 222. hit:Jungle |
| 133. gtr:Dooooom | 178. hit:Caprice | 223. hit:Bongo Fury |
| 134. pad:Drone 1 | 179. hit:Sax Line | 224. hit:Drop Off |
| 135. pad:Drone 2 | 180. gtr:Owp Hit | 225. syn:2 Step |
| 136. pad:Drone 3 | 181. hit:Bottom 1 | 226. hit:the Snap |
| 137. pad:Sirens | 182. hit:Bottom 2 | 227. sfx:HookReverse |
| 138. hit:Guit n Hat | 183. hit:Nice Under | 228. brs:Tasty Lick |
| 139. hit:Wah Kicker | 184. hit:Nice Under 2 | 229. brs:Next Tasty 1 |
| 140. hit:Satisfying | 185. hit:Righteous | 230. brs:NotherTasty |
| 141. hit:SP12OrgChord | 186. sfx:Cop Tone 1 | 231. brs:Next Tasty 2 |
| 142. hit:Weird Gtr | 187. sfx:Cop Tone 2 | 232. syn:Flutey |
| 143. led:DeepThoughts | 188. sfx:Beep Tone 1 | 233. hit:Brass Attack |
| 144. led:Fantastic70s | 189. sfx:Beep Tone 2 | 234. gtr:Single Next |
| 145. led:Guitlet Wave | 190. sfx:ComputerBeep | 235. brs:Falling |
| 146. syn:Synthomatic | 191. sfx:Ping Beep | 236. brs:Sfz |
| 147. led:Transformed | 192. hit:Key Kord min | 237. syn:Grinder |
| 148. brs:Caliente! | 193. hit:X | 238. hit:HardSynStab1 |
| 149. hit:Tpt Solo | 194. hit:Honk | 239. hit:HardSynStab2 |
| 150. led:Hoodwormed | 195. sfx:Dial 8 | 240. brs:Quirky Hit |
| 151. led:Yearning 2 B | 196. sfx:Dial 6 | 241. hit:StressRelief |
| 152. led:ReedOPlenty | 197. sfx:Dial 5 | 242. hit:Korn |
| 153. led:AmberVioleta | 198. sfx:Dial 4 | 243. syn:Wheeeeper |
| 154. led:Stevie Rockz | 199. sfx:Dial 3 | 244. hit:It's A... |
| 155. pad:Mr. Clean | 200. sfx:Dial 2 | 245. hit:It's A nothr |
| 156. sfx:Shield | 201. sfx:Dial 1 | 246. hit:Rap Zapper |
| 157. sfx:Deadly Cycle | 202. hit:Annoy | 247. hit:Uplifter |
| 158. sfx:Reaper | 203. hit:Orchit | 248. hit:Good'Nuff |
| 159. vox:Atseeyeah | 204. brs:Waver Stab | 249. hit:Laser Strike |
| 160. pad:Pulsar | 205. brs:40's Horn | 250. hit:Wild Horns |
| 161. gtr:1ShotElectra | 206. sfx:Bat | 251. hit:Cluster |
| 162. brs:CarnavalHits | 207. hit:Bass Note | 252. hit:To the Point |
| 163. brs:Carnaval 1 | 208. hit:Hatthang | 253. hit:Tentative |
| 164. brs:Carnaval 2 | 209. sfx:AmusemntCrwd | 254. hit:Mood Swing |
| 165. brs:Carnaval 3 | 210. hit:SynChord | 255. syn:Sea Story |
| 166. brs:Carnaval 4 | 211. hit:Synthetic | 256. str:Fade Hit |
| 167. brs:Carnaval 5 | 212. hit:Padlove | 257. hit:Sentimental |
| 168. hit:Spicy Brass | 213. hit:8 Bit Fright | 258. hit:DeD RINGER |
| 169. sfx:Worry Pad | 214. hit:Synth Ditty | 259. hit:Chord Ends |
| 170. str:Orcha Chord | 215. hit:House Chrd ? | 260. hit:Monster |
| 171. hit:DeathStrike | 216. hit:HornStabber | 261. hit:SP Super |

Instrument Listing

262.	hit:With 2 Tts	307.	str:Interrupted	352.	syn:Vox Pad
263.	hit:Splashy	308.	str:Section Pizz	353.	vox:TB Pad 1
264.	str:SP Suspense	309.	str:Orch Harp	354.	vox:TB Pad 2
265.	hit:Weird Nylon	310.	str:Hybrid Synth	355.	vox:Talk Brush
266.	hit:Sp Reversal	311.	str:Sctn Legato	356.	gtr:DistantCry
267.	gtr:Mood Riff	312.	str:Synthetic	357.	gtr:Heavy
268.	syn:BrassProphet	313.	str:MoodChrdStab	358.	syn:Vox Roller
269.	pad:Plucked Gold	314.	str:Mood Stab 2	359.	vox:TB Boom 1
270.	syn:Winny	315.	str:Harp Gliss	360.	vox:TB Boom 2
271.	syn:P5 Sync	316.	str:Screenplay	361.	vox:TB Boom 3
272.	wav:Sinusoid	317.	str:Sp Looopy	362.	vox:TB Boom 4
273.	wav:Sine /\ 2	318.	hit:Brass Balls	363.	vox:TB Boom 5
274.	wav:SineInvert/\2	319.	str:Hip Hop Pizz	364.	vox:TB Boom 6
275.	wav:Sine /\ 3	320.	str:Big PluckHit	365.	vox:TB Do It 1
276.	wav:SineInvert/\3	321.	str:Rap OrchRiff	366.	vox:TB Do It 2
277.	wav:Sawtooth	322.	str:Heartbreaker	367.	vox:TB Do It 3
278.	wav:Square	323.	vox:TB Ooh! 1	368.	vox:TB Do It 4
279.	wav:Triangle	324.	vox:TB Ooh! 2	369.	vox:TB Do It 5
280.	key:010 El Tine	325.	vox:Talk Box Ooh	370.	vox:TB Oh Yeah 1
281.	key:1 Note Mello	326.	vox:Talk Box Aha	371.	vox:TB Oh Yeah 2
282.	key:Nother1Noter	327.	vox:Freak!	372.	vox:TB Oh Yeah 3
283.	key:010 FuzzTine	328.	vox:TBLet'sDance	373.	vox:TB Oh Yeah 4
284.	key:Res 1 Shot	329.	vox:Booms!	374.	vox:TB Oh Yeah 5
285.	key:Chords/Hits	330.	vox:Doit!	375.	vox:TB Oh Yeah 6
286.	key:KoolOrgKord1	331.	vox:Oh Yeahs!	376.	vox:TB Oh Yeah 7
287.	key:Kool Kord 2	332.	vox:Dan Cher 1	377.	vox:TB Vowel A
288.	key:Rhodes FX 1	333.	vox:Dan Cher 2	378.	vox:TB Vowel E
289.	key:WindowLetGo	334.	vox:Funky 1	379.	vox:TB Vowel I
290.	key:Loop da Loop	335.	vox:Funky 2	380.	vox:TB Vowel O
291.	key:Growl Drop	336.	vox:All Vowels	381.	vox:TB Vowel U
292.	key:Org Roll 1	337.	vox:AllNTPVowels	382.	vox:TB Vowel Ah
293.	key:Harpsinote	338.	vox:VowelEachOct	383.	vox:TB Vowel Eh
294.	hit:DanceKey1	339.	vox:Vowel Train	384.	vox:TB Vowel Uh
295.	hit:DanceKey2	340.	vox:Vowel Train2	385.	vox:TB Vowel Oo
296.	hit:DanceKey3	341.	vox:Vocoder	386.	vox:Gina Ew 1
297.	hit:DanceKey4	342.	vox:All Men	387.	vox:Gina Ew 2
298.	hit:DanceKey5	343.	vox:All Femmes	388.	vox:Earth Lisa
299.	hit:Organ	344.	vox:Owwwwwwww	389.	vox:Male 1
300.	hit:Maj Org	345.	vox:Screamer	390.	vox:Male 2
301.	hit:DirtyTine	346.	vox:YahWailer	391.	vox:Male 3
302.	hit:Piano Lick	347.	vox:Wassup???	392.	vox:Male 4
303.	hit:In Concert	348.	vox:Techno Yeah	393.	vox:Male 5
304.	key:Kool Kord	349.	vox:Scratch Talk	394.	vox:Male 6
305.	key:Nother 'No	350.	hit:Scratch Box	395.	vox:Male 7
306.	key:Perc Organ	351.	vox:Podge	396.	vox:Male 8

Instrument Listing

397.	vox:Male 9	442.	prc:All Kicks 2	487.	kit:Lily GM5
398.	vox:Male 10	443.	prc:Kicks2 Tuned	488.	kit:Funky GM One
399.	vox:Femme 1	444.	prc:All Snares 1	489.	kit:Funky GM 2
400.	vox:Femme 2	445.	prc:All Snares 2	490.	kit:Funky GM 3
401.	vox:Femme 3	446.	prc:All Snares 3	491.	kit:Funky 4
402.	vox:Femme 4	447.	prc:KikSnarePlc1	492.	kit:Funky 5
403.	vox:Femme 5	448.	prc:All Hats 1	493.	kit:Funky 6
404.	vox:Femme 6	449.	prc:All Hats 2	494.	prc:Kick 1
405.	vox:Femme 7	450.	prc:All Cymbals	495.	prc:Kick 2
406.	vox:Femme 8	451.	prc:Rainstick	496.	prc:Kick 3
407.	vox:Femme 9	452.	prc:Whirlybird	497.	prc:Kick 4
408.	vox:Femme 10	453.	prc:All Stix	498.	prc:Kick 5
409.	vox:Femme 11	454.	prc:All Bongos	499.	prc:Kick 6
410.	vox:Femme 12	455.	prc:AllClaps&Snp	500.	prc:Kick 7
411.	vox:Femme 13	456.	prc:All Claves	501.	prc:Kick 8
412.	key:Farfisa Low	457.	prc:All Toms	502.	prc:Kick 9
413.	key:Farfisa	458.	prc:All Bells	503.	prc:Kick 10
414.	key:Vox Organ	459.	prc:All Fills	504.	prc:Kick 11
415.	key:Organ 1	460.	prc:All Shakers	505.	prc:Kick 12
416.	key:Organ 2	461.	scr:AllScratches	506.	prc:Kick 13
417.	key:Org Day	462.	prc:All Misc	507.	prc:Kick 14
418.	key:Org Nod	463.	sfx:ScaryBastard	508.	prc:Kick 15
419.	key:Org Lite	464.	prc:Sci Fi Toy 1	509.	prc:Kick 16
420.	key:Disco Organ	465.	prc:Sci Fi Toy 2	510.	prc:Kick 17
421.	key:DX Organ	466.	prc:Thumpiano	511.	prc:Kick 18
422.	key:JX Organ	467.	scr:Scratch Map	512.	prc:Kick 19
423.	led:Full Force	468.	scr:Scratch Talk	513.	prc:Kick 20
424.	syn:Brite Brass	469.	scr:Rodeo Roper	514.	prc:Kick 21
425.	syn:Muted Brass	470.	scr:ChipmunkRap	515.	prc:Kick 22
426.	syn:Classic 1	471.	scr:StuttrSteppr	516.	prc:Kick 23
427.	syn:Classic 2	472.	scr:Whale Backer	517.	prc:Kick 24
428.	syn:EdgyVeryEdgy	473.	scr:Nother Drop	518.	prc:Kick 25
429.	syn:Tone Wall	474.	scr:Hiccup	519.	prc:Kick 26
430.	syn:Jungle Lead	475.	scr:Rotator	520.	prc:Kick 27
431.	led:Wormy 1	476.	scr:Hard Drop	521.	prc:Kick 28
432.	led:Wormy 2	477.	prc:Shaker Loop	522.	prc:Kick 29
433.	led:Wormy 3	478.	prc:St Flexi 1	523.	prc:Kick 30
434.	led:H20	479.	prc:Flexi 2	524.	prc:Kick 31
435.	syn:Wave Cutter	480.	prc:Flexi 3	525.	prc:Kick 32
436.	syn:Rail to Rail	481.	prc:Flexi 4	526.	prc:Kick 33
437.	key:Klavin It	482.	prc:Flexi 5	527.	prc:Kick 34
438.	key:Klav Love	483.	kit:Lily GM1	528.	prc:Kick 35
439.	key:Klav Love b	484.	kit:Lily GM2	529.	prc:Kick 36
440.	syn:Buzz Wave	485.	kit:Lily GM3	530.	prc:Kick 37
441.	prc:All Kicks 1	486.	kit:Lily GM4	531.	prc:Kick 38

Instrument Listing

532.	prc:Kick 39	576.	key:Tine Hit 2	620.	prc:Snare 39
533.	prc:Kick 40	577.	key:Tine Hit 3	621.	prc:Snare 40
534.	prc:Kick 41	578.	key:Tine Hit 4	622.	prc:Snare 41
535.	prc:Kick 42	579.	key:Tine Hit 5	623.	prc:Snare 42
536.	prc:Kick 43	580.	key:Tine Hit 6	624.	prc:Snare 43
537.	prc:Kick 44	581.	key:Tine Hit 7	625.	prc:Snare 44
538.	prc:Kick 45	582.	prc:Snare 1	626.	prc:Snare 45
539.	prc:Kick 46	583.	prc:Snare 2	627.	prc:Snare 46
540.	prc:Kick 47	584.	prc:Snare 3	628.	prc:Snare 47
541.	prc:Kick 48	585.	prc:Snare 4	629.	prc:Snare 48
542.	prc:Kick 49	586.	prc:Snare 5	630.	prc:Snare 49
543.	prc:Kick 50	587.	prc:Snare 6	631.	prc:Snare 50
544.	prc:Kick 51	588.	prc:Snare 7	632.	prc:Snare 51
545.	prc:Kick 52	589.	prc:Snare 8	633.	prc:Snare 52
546.	prc:Kick 53	590.	prc:Snare 9	634.	prc:Snare 53
547.	prc:Kick 54	591.	prc:Snare 10	635.	prc:Snare 54
548.	prc:Kick 55	592.	prc:Snare 11	636.	prc:Snare 55
549.	prc:Kick 56	593.	prc:Snare 12	637.	prc:Snare 56
550.	prc:Kick 57	594.	prc:Snare 13	638.	prc:Snare 57
551.	prc:Kick 58	595.	prc:Snare 14	639.	prc:Snare 58
552.	prc:Kick 59	596.	prc:Snare 15	640.	prc:Snare 59
553.	prc:Kick 60	597.	prc:Snare 16	641.	prc:Snare 60
554.	prc:Kick 61	598.	prc:Snare 17	642.	prc:Snare 61
555.	prc:Kick 62	599.	prc:Snare 18	643.	prc:Snare 62
556.	prc:Kick 63	600.	prc:Snare 19	644.	prc:Snare 63
557.	prc:Kick 64	601.	prc:Snare 20	645.	prc:Snare 64
558.	prc:Kick 65	602.	prc:Snare 21	646.	prc:Snare 65
559.	prc:Kick 66	603.	prc:Snare 22	647.	prc:Snare 66
560.	prc:Kick 67	604.	prc:Snare 23	648.	prc:Snare 67
561.	prc:Kick 68	605.	prc:Snare 24	649.	prc:Snare 68
562.	prc:Kick 69	606.	prc:Snare 25	650.	prc:Snare 69
563.	prc:Kick 70	607.	prc:Snare 26	651.	prc:Snare 70
564.	prc:Kick 71	608.	prc:Snare 27	652.	prc:Snare 71
565.	prc:Kick 72	609.	prc:Snare 28	653.	prc:Snare 72
566.	prc:Kick 73	610.	prc:Snare 29	654.	prc:Snare 73
567.	prc:Kick 74	611.	prc:Snare 30	655.	prc:Snare 74
568.	key:Tine Chord 1	612.	prc:Snare 31	656.	prc:Snare 75
569.	key:Tine Chord 2	613.	prc:Snare 32	657.	prc:Snare 76
570.	key:Tine Chord 3	614.	prc:Snare 33	658.	prc:Snare 77
571.	key:Tine Chord 4	615.	prc:Snare 34	659.	prc:Snare 78
572.	key:Tine Chord 5	616.	prc:Snare 35	660.	prc:Snare 79
573.	key:Tine Chord 6	617.	prc:Snare 36	661.	prc:Snare 80
574.	key:Tine Chord 7	618.	prc:Snare 37	662.	prc:Snare 81
575.	key:Tine Hit 1	619.	prc:Snare 38	663.	prc:Snare 82

Instrument Listing

664.	prc:Snare 83	708.	prc:Snare 127	752.	kit:Electronica1
665.	prc:Snare 84	709.	prc:Snare 128	753.	kit:Dub Reggae
666.	prc:Snare 85	710.	prc:Snare 129	754.	kit:DarkBeats
667.	prc:Snare 86	711.	prc:Snare 130	755.	kit:DarkBeats2
668.	prc:Snare 87	712.	prc:Snare 131	756.	kit:LoFi Kit
669.	prc:Snare 88	713.	prc:Snare 132	757.	kit:Nu Metal
670.	prc:Snare 89	714.	prc:Snare 133	758.	hit:All Hits 1
671.	prc:Snare 90	715.	prc:Snare 134	759.	rom:Thru Memory
672.	prc:Snare 91	716.	prc:Snare 135	760.	rom:Vowels
673.	prc:Snare 92	717.	prc:Snare 136	761.	hit:All Hits 2
674.	prc:Snare 93	718.	prc:Snare 137	762.	kit:1NoHats
675.	prc:Snare 94	719.	prc:Snare 138	763.	kit:1NoKickSnare
676.	prc:Snare 95	720.	prc:Snare 139	764.	kit:2NoHats
677.	prc:Snare 96	721.	prc:Snare 140	765.	kit:2NoKickSnare
678.	prc:Snare 97	722.	prc:Snare 141	766.	kit:3NoHats
679.	prc:Snare 98	723.	prc:Snare 142	767.	kit:3NoKickSnare
680.	prc:Snare 99	724.	prc:Snare 143	768.	kit:4NoHats
681.	prc:Snare 100	725.	prc:Snare 144	769.	kit:4NoKickSnare
682.	prc:Snare 101	726.	prc:Snare 145	770.	kit:5NoHats
683.	prc:Snare 102	727.	prc:Snare 146	771.	kit:5NoKickSnare
684.	prc:Snare 103	728.	prc:Snare 147	772.	kit:6NoHats
685.	prc:Snare 104	729.	prc:Snare 148	773.	kit:6NoKickSnare
686.	prc:Snare 105	730.	prc:Snare 149	774.	kit:7NoHats
687.	prc:Snare 106	731.	prc:Snare 150	775.	kit:7NoKickSnare
688.	prc:Snare 107	732.	prc:Snare 151	776.	kit:8NoHats
689.	prc:Snare 108	733.	prc:Snare 152	777.	kit:8NoKickSnare
690.	prc:Snare 109	734.	prc:Snare 153	778.	kit:9NoHats
691.	prc:Snare 110	735.	prc:Snare 154	779.	kit:9NoKickSnare
692.	prc:Snare 111	736.	prc:Snare 155	780.	kit:10NoHats
693.	prc:Snare 112	737.	prc:Snare 156	781.	kit:10NoKikSnare
694.	prc:Snare 113	738.	prc:Snare 157	782.	kit:11NoHats
695.	prc:Snare 114	739.	prc:Snare 158	783.	kit:11NoKikSnare
696.	prc:Snare 115	740.	prc:Snare 159	784.	kit:12NoHats
697.	prc:Snare 116	741.	prc:Snare 160	785.	kit:12NoKikSnare
698.	prc:Snare 117	742.	prc:Snare 161	786.	kit:13NoHats
699.	prc:Snare 118	743.	prc:Snare 162	787.	kit:13NoKikSnare
700.	prc:Snare 119	744.	prc:Snare 163	788.	kit:14NoHats
701.	prc:Snare 120	745.	prc:Snare 164	789.	kit:14NoKikSnare
702.	prc:Snare 121	746.	prc:Snare 165	790.	kit:15NoHats
703.	prc:Snare 122	747.	prc:Snare 166	791.	kit:15NoKikSnare
704.	prc:Snare 123	748.	prc:Snare 167	792.	kit:16NoHats
705.	prc:Snare 124	749.	prc:Snare 168	793.	kit:16NoKikSnare
706.	prc:Snare 125	750.	kit:Nu Soul	794.	kit:17NoHats
707.	prc:Snare 126	751.	kit:80s+Drm&Bass	795.	kit:17NoKikSnare

Instrument Listing

796.	kit:18NoHats	840.	prc:Hat 33	884.	prc:Hat 77
797.	kit:18NoKikSnare	841.	prc:Hat 34	885.	prc:Cymbal 1
798.	kit:19NoHats	842.	prc:Hat 35	886.	prc:Cymbal 2
799.	kit:19NoKikSnare	843.	prc:Hat 36	887.	prc:Cymbal 3
800.	gtr:Scrape 1	844.	prc:Hat 37	888.	prc:Cymbal 4
801.	gtr:Strum Up	845.	prc:Hat 38	889.	prc:Cymbal 5
802.	gtr:Strum Down	846.	prc:Hat 39	890.	prc:Cymbal 6
803.	gtr:Bonk	847.	prc:Hat 40	891.	prc:Cymbal 7
804.	gtr:Chop	848.	prc:Hat 41	892.	prc:Cymbal 8
805.	gtr:Pick Noise	849.	prc:Hat 42	893.	prc:Cymbal 9
806.	vox:All Talkbox	850.	prc:Hat 43	894.	prc:Cymbal 10
807.	str:StackedLegs	851.	prc:Hat 44	895.	prc:Cymbal 11
808.	prc:Hat 1	852.	prc:Hat 45	896.	prc:Cymbal 12
809.	prc:Hat 2	853.	prc:Hat 46	897.	prc:Cymbal 13
810.	prc:Hat 3	854.	prc:Hat 47	898.	prc:Cymbal 14
811.	prc:Hat 4	855.	prc:Hat 48	899.	prc:Cymbal 15
812.	prc:Hat 5	856.	prc:Hat 49	900.	prc:Cymbal 16
813.	prc:Hat 6	857.	prc:Hat 50	901.	prc:Cymbal 17
814.	prc:Hat 7	858.	prc:Hat 51	902.	prc:Cymbal 18
815.	prc:Hat 8	859.	prc:Hat 52	903.	prc:Cymbal 19
816.	prc:Hat 9	860.	prc:Hat 53	904.	prc:Cymbal 20
817.	prc:Hat 10	861.	prc:Hat 54	905.	prc:Bongo 1
818.	prc:Hat 11	862.	prc:Hat 55	906.	prc:Bongo 2
819.	prc:Hat 12	863.	prc:Hat 56	907.	prc:Bongo 3
820.	prc:Hat 13	864.	prc:Hat 57	908.	prc:Bongo 4
821.	prc:Hat 14	865.	prc:Hat 58	909.	prc:Bongo 5
822.	prc:Hat 15	866.	prc:Hat 59	910.	prc:Bongo 6
823.	prc:Hat 16	867.	prc:Hat 60	911.	prc:Bongo 7
824.	prc:Hat 17	868.	prc:Hat 61	912.	prc:Bongo 8
825.	prc:Hat 18	869.	prc:Hat 62	913.	prc:Bongo 9
826.	prc:Hat 19	870.	prc:Hat 63	914.	prc:Bongo 10
827.	prc:Hat 20	871.	prc:Hat 64	915.	prc:Bongo 11
828.	prc:Hat 21	872.	prc:Hat 65	916.	prc:Bongo 12
829.	prc:Hat 22	873.	prc:Hat 66	917.	prc:Bongo 13
830.	prc:Hat 23	874.	prc:Hat 67	918.	prc:Bongo 14
831.	prc:Hat 24	875.	prc:Hat 68	919.	prc:Bongo 15
832.	prc:Hat 25	876.	prc:Hat 69	920.	prc:Bongo 16
833.	prc:Hat 26	877.	prc:Hat 70	921.	prc:Bongo 17
834.	prc:Hat 27	878.	prc:Hat 71	922.	prc:Claps&Snp 1
835.	prc:Hat 28	879.	prc:Hat 72	923.	prc:Claps&Snp 2
836.	prc:Hat 29	880.	prc:Hat 73	924.	prc:Claps&Snp 3
837.	prc:Hat 30	881.	prc:Hat 74	925.	prc:Claps&Snp 4
838.	prc:Hat 31	882.	prc:Hat 75	926.	prc:Claps&Snp 5
839.	prc:Hat 32	883.	prc:Hat 76	927.	prc:Claps&Snp 6

Instrument Listing

928.	prc:Claps&Snp 7	972.	prc:Tom 20	1016.	prc:Shaker 15
929.	prc:Claps&Snp 8	973.	prc:Tom 21	1017.	prc:Shaker 16
930.	prc:Claps&Snp 9	974.	prc:Tom 22	1018.	prc:Shaker 17
931.	prc:Claps&Snp 10	975.	prc:Bell 1	1019.	prc:Shaker 18
932.	prc:Claps&Snp 11	976.	prc:Bell 2	1020.	prc:Shaker 19
933.	prc:Claps&Snp 12	977.	prc:Bell 3	1021.	prc:Shaker 20
934.	prc:Claps&Snp 13	978.	prc:Bell 4	1022.	prc:Shaker 21
935.	prc:Claps&Snp 14	979.	prc:Bell 5	1023.	prc:Shaker 22
936.	prc:Clave 1	980.	prc:Bell 6	1024.	prc:Shaker 23
937.	prc:Clave 2	981.	prc:Bell 7	1025.	prc:Shaker 24
938.	prc:Clave 3	982.	prc:Bell 8	1026.	prc:Shaker 25
939.	prc:Clave 4	983.	prc:Bell 9	1027.	prc:Shaker 26
940.	prc:Clave 5	984.	prc:Bell 10	1028.	prc:Shaker 27
941.	prc:Clave 6	985.	prc:Bell 11	1029.	prc:Shaker 28
942.	prc:Clave 7	986.	prc:Bell 12	1030.	prc:Shaker 29
943.	prc:Clave 8	987.	prc:Bell 13	1031.	prc:Misc 1
944.	prc:Clave 9	988.	prc:Bell 14	1032.	prc:Misc 2
945.	prc:Clave 10	989.	prc:Bell 15	1033.	prc:Misc 3
946.	prc:Clave 11	990.	prc:Bell 16	1034.	prc:Misc 4
947.	prc:Clave 12	991.	prc:Fill Etc 1	1035.	prc:Misc 5
948.	prc:Clave 13	992.	prc:Fill Etc 2	1036.	prc:Misc 6
949.	prc:Clave 14	993.	prc:Fill Etc 3	1037.	prc:Misc 7
950.	prc:Clave 15	994.	prc:Fill Etc 4	1038.	prc:Misc 8
951.	prc:Clave 16	995.	prc:Fill Etc 5	1039.	prc:Misc 9
952.	prc:Clave 17	996.	prc:Fill Etc 6	1040.	prc:Misc 10
953.	prc:Tom 1	997.	prc:Fill Etc 7	1041.	prc:Misc 11
954.	prc:Tom 2	998.	prc:Fill Etc 8	1042.	prc:Misc 12
955.	prc:Tom 3	999.	prc:Fill Etc 9	1043.	prc:Misc 13
956.	prc:Tom 4	1000.	prc:Fill Etc 10	1044.	prc:Misc 14
957.	prc:Tom 5	1001.	prc:Fill Etc 11	1045.	prc:Misc 15
958.	prc:Tom 6	1002.	prc:Shaker 1	1046.	prc:Misc 16
959.	prc:Tom 7	1003.	prc:Shaker 2	1047.	prc:Misc 17
960.	prc:Tom 8	1004.	prc:Shaker 3	1048.	prc:Misc 18
961.	prc:Tom 9	1005.	prc:Shaker 4	1049.	prc:Misc 19
962.	prc:Tom 10	1006.	prc:Shaker 5	1050.	prc:Misc 20
963.	prc:Tom 11	1007.	prc:Shaker 6	1051.	prc:Misc 21
964.	prc:Tom 12	1008.	prc:Shaker 7	1052.	prc:Misc 22
965.	prc:Tom 13	1009.	prc:Shaker 8	1053.	prc:Misc 23
966.	prc:Tom 14	1010.	prc:Shaker 9	1054.	prc:Misc 24
967.	prc:Tom 15	1011.	prc:Shaker 10	1055.	prc:Misc 25
968.	prc:Tom 16	1012.	prc:Shaker 11	1056.	prc:Misc 26
969.	prc:Tom 17	1013.	prc:Shaker 12	1057.	prc:Misc 27
970.	prc:Tom 18	1014.	prc:Shaker 13	1058.	prc:Misc 28
971.	prc:Tom 19	1015.	prc:Shaker 14	1059.	prc:Misc 29

Instrument Listing

1060. prc:Misc 30	1074. prc:Misc 44	1088. prc:Misc 58
1061. prc:Misc 31	1075. prc:Misc 45	1089. prc:Misc 59
1062. prc:Misc 32	1076. prc:Misc 46	1090. prc:Misc 60
1063. prc:Misc 33	1077. prc:Misc 47	1091. prc:Misc 61
1064. prc:Misc 34	1078. prc:Misc 48	1092. prc:Misc 62
1065. prc:Misc 35	1079. prc:Misc 49	1093. prc:Misc 63
1066. prc:Misc 36	1080. prc:Misc 50	1094. prc:Misc 64
1067. prc:Misc 37	1081. prc:Misc 51	1095. prc:Misc 65
1068. prc:Misc 38	1082. prc:Misc 52	1096. prc:Misc 66
1069. prc:Misc 39	1083. prc:Misc 53	1097. prc:Misc 67
1070. prc:Misc 40	1084. prc:Misc 54	1098. prc:Misc 68
1071. prc:Misc 41	1085. prc:Misc 55	1099. prc:Misc 69
1072. prc:Misc 42	1086. prc:Misc 56	1100. prc:Misc 70
1073. prc:Misc 43	1087. prc:Misc 57	

Riff Listing

- | | | |
|---------------------|----------------------|-----------------------|
| 1. AUD-C Triad | 45. BAS-TheOtherMarc | 89. GTR-Sprinkle |
| 2. AUD-C1 (4 bars) | 46. BAS-Upright One | 90. GTR-Strata |
| 3. AUD-C3 (1 bar) | 47. BAS-WarmWelcome | 91. GTR-Strata 2 |
| 4. AUD-C3 (2 Bars) | 48. BAS-WoofaWrekka | 92. GTR-StrumGlass |
| 5. AUD-C3 (4 Bars) | 49. BRS-Bigg | 93. GTR-Wacka 113 |
| 6. AUD-C4 | 50. BRS-BrassTine | 94. GTR-Wacka 96 |
| 7. AUD-Cm7 | 51. BRS-Hitz | 95. GTR-Wackaloo |
| 8. AUD-Cm9 | 52. BRS-Caliente | 96. GTR-Wah Not |
| 9. AUD-Cmaj7 | 53. BRS-Crunchy | 97. GTR-WahScale4 |
| 10. AUD-Cs Up | 54. BRS-Lotsa | 98. GTR-WeezlFuzz |
| 11. AUD-Cs Up-Down | 55. BRS-Lotsa2 | 99. HIT-DroppinOff |
| 12. AMB-Underground | 56. BRS-Philta | 100. HIT-GuitHat |
| 13. AMB-Vocoder | 57. BRS-SlapDatBrass | 101. HIT-InConcert |
| 14. BAS-Acid1 | 58. BRS-SlapDat 2 | 102. HIT-KnockUOut |
| 15. BAS-Bagg | 59. GTR-AllWahs | 103. HIT-Nice Under |
| 16. BAS-BellyButton | 60. GTR-Burnt | 104. HIT-OrgCreepT |
| 17. BAS-Decision99 | 61. GTR-Chord Bed | 105. HIT-Satisfying |
| 18. BAS-EatMe | 62. GTR-Cyclone | 106. HIT-Serious |
| 19. BAS-Funk PM | 63. GTR-DissedHit | 107. HIT-Serious2 |
| 20. BAS-Funk Pop | 64. GTR-Fine Slide | 108. HIT-Splash |
| 21. BAS-Funk Slap | 65. GTR-Flange Pick | 109. HIT-StrikezAgain |
| 22. BAS-GutPunched | 66. GTR-Gen X | 110. HIT-Sweet |
| 23. BAS-HarpOS1 | 67. GTR-Gen X 2 | 111. KEY-010FuzzTine |
| 24. BAS-HarpOS2 | 68. GTR-GenerEl | 112. KEY-1NoteMello |
| 25. BAS-HarpOS3 | 69. GTR-Grit Slide | 113. KEY-ChordsHits |
| 26. BAS-HellaBoom | 70. GTR-Grunge | 114. KEY-ChordsHits2 |
| 27. BAS-Hummertime | 71. GTR-HrndrixWah | 115. KEY-CityGiggin |
| 28. BAS-InTheory | 72. GTR-Lik Choppy | 116. KEY-DX Organ |
| 29. BAS-It Too | 73. GTR-LikeThisLik | 117. KEY-Far fg nOrgn |
| 30. BAS-KeyONate | 74. GTR-Mood Riff | 118. KEY-GrowlDrop |
| 31. BAS-Persistence | 75. GTR-Nylon | 119. KEY-HarpsiFlange |
| 32. BAS-PluckySynth | 76. GTR-Nylon 1 2 | 120. KEY-Horror Glide |
| 33. BAS-RezRipper | 77. GTR-Nylon 2 | 121. KEY-HybridSweep |
| 34. BAS-SP Stand-Up | 78. GTR-Nylon 2 2 | 122. KEY-Keystone |
| 35. BAS-SlapPop | 79. GTR-NylonArp | 123. KEY-Klavin It |
| 36. BAS-SonicSine | 80. GTR-NylonArp2 | 124. KEY-KoolKord |
| 37. BAS-Soulified | 81. GTR-NylonFantasy | 125. KEY-Mo 88 |
| 38. BAS-Speakeasy | 82. GTR-One Shot | 126. KEY-Mo E Dan |
| 39. BAS-Standin | 83. GTR-PhiltaSweep | 127. KEY-Org Roll |
| 40. BAS-SubsonicTRi | 84. GTR-Pinky Fingaz | 128. KEY-OrgLite |
| 41. BAS-Talk2Me | 85. GTR-Pop 2 | 129. KEY-OrgRoll2 |
| 42. BAS-Technoid | 86. GTR-RBNylonWav | 130. KEY-OrgStoneGruv |
| 43. BAS-TheDeepest | 87. GTR-SlideHit | 131. KEY-Perc Org |
| 44. BAS-TheDeepest2 | 88. GTR-Slo Strum | 132. KEY-Sitar 88 |

Riff Listing

- | | | |
|-----------------------|-----------------------|-----------------------|
| 133. KEY-Vinyl 73 | 177. SYN-LadyOrg1 | 221. KIT-MarchMadnezZ |
| 134. KEY-WahChunk | 178. SYN-LadyOrg2 | 222. KIT-Mo Dist |
| 135. LED-70s Lead | 179. SYN-PLUCKY | 223. KIT-Music2DrivBy |
| 136. LED-Deep Thought | 180. SYN-Prosycn | 224. KIT-New Beat |
| 137. LED-Fantasy | 181. SYN-Silkworm | 225. KIT-NuMetal |
| 138. LED-Fantasy | 182. SYN-Syco Girl | 226. KIT-Oh Yeah |
| 139. LED-ProphetLine | 183. SYN-Wan X | 227. KIT-OnDaStreet |
| 140. LED-Raveline | 184. SYN-Weeperr | 228. KIT-Perky |
| 141. LED-Raveline2 | 185. SYN-Winny | 229. KIT-Perky2 |
| 142. LED-SineWorm | 186. VOX-Agony Agony | 230. KIT-PhiltaFreak |
| 143. LED-SineWorm2 | 187. VOX-DaddysGal | 231. KIT-PhiltaFreak2 |
| 144. PAD-Addtive Org | 188. VOX-Voicyst | 232. KIT-Relapse |
| 145. PAD-Cherubs | 189. VOX-Voxcade | 233. KIT-Relapse2 |
| 146. PAD-Cherubs 2 | 190. WAV-Sinusoid | 234. KIT-ScratchHead |
| 147. PAD-DanceLitez | 191. WAV-Square | 235. KIT-Slappy |
| 148. PAD-DeadMetal1 | 192. PRC-Kicks 1 | 236. KIT-SubwayTunnel |
| 149. PAD-Drone 1 | 193. PRC-Kix 1 | 237. KIT-The Ultimate |
| 150. PAD-Drone 1 2 | 194. PRC-Kix 2 | 238. KIT-ThugitUp |
| 151. PAD-Drone 2 | 195. PRC-Misc | 239. KIT-TimesSquare |
| 152. PAD-DroneSwirl | 196. PRC-Per Oct | 240. KIT-U Aint |
| 153. PAD-OBLayer1 | 197. PRC-Scratches | 241. KIT-U No |
| 154. PAD-PluckedGold | 198. KIT-AllmyMoMees | 242. KIT-Vilper |
| 155. PAD-StringLayer | 199. KIT-BettaBeata | 243. KIT-Vilper2 |
| 156. PAD-StringLayr2 | 200. KIT-Construction | 244. KIT-Warp |
| 157. PAD-TheMadSweep | 201. KIT-CornaSto | 245. KIT-Wide One |
| 158. SFX-Solar Babies | 202. KIT-CornaSto2 | 246. KIT-WideOne2 |
| 159. SFX-WooleyBob | 203. KIT-Crunch | 247. KIT-Woo Kid |
| 160. SFX-YaYAYA | 204. KIT-DarkFlower | 248. BTS-8nt Urz |
| 161. STR-BalladHarp | 205. KIT-DarkFlower2 | 249. BTS-AllMyMomeeS |
| 162. STR-BalladHarp2 | 206. KIT-DePhlanga | 250. BTS-BabyDoll |
| 163. STR-Harpo | 207. KIT-FriscoLayer | 251. BTS-Beat Prophet |
| 164. STR-HybridSynth | 208. KIT-Funk 4 Life | 252. BTS-Becky Boise |
| 165. STR-PizzStrings | 209. KIT-GM One | 253. BTS-Can I Talk |
| 166. STR-Oops | 210. KIT-GM Two | 254. BTS-ClapYoHandZ |
| 167. STR-OrchHarp | 211. KIT-GuessWhosBak | 255. BTS-CreatrLayr |
| 168. STR-Sa-Spen Ful | 212. KIT-HappyZ | 256. BTS-CreatrLayr2 |
| 169. STR-SectionPizz | 213. KIT-HiverJiver | 257. BTS-DJ GLO Jenkn |
| 170. STR-Suspense | 214. KIT-Hot n Steamy | 258. BTS-DialToneZ |
| 171. STR-SynthString | 215. KIT-KattznJammah | 259. BTS-DirTay drTee |
| 172. STR-Virgoe | 216. KIT-KlasicStudio | 260. BTS-DoiTZ |
| 173. SYN-2 Step | 217. KIT-Klippy | 261. BTS-Dr. Banner |
| 174. SYN-AgonyOrgon | 218. KIT-Lesster | 262. BTS-FemaleBasher |
| 175. SYN-BrassProphet | 219. KIT-MO GM 1 | 263. BTS-GLO BabieeS |
| 176. SYN-Classic 1 | 220. KIT-MarchMadness | 264. BTS-Geechee GLO |

Riff Listing

- | | | |
|------------------------------|-----------------------------|------------------------------|
| 265. BTS-GrungeZ | 277. BTS-Lily 4 | 289. BTS-ShakitZ |
| 266. BTS-HeY | 278. BTS-Lily 5 | 290. BTS-SistaHoney |
| 267. BTS-Hot n Steam2 | 279. BTS-Luv Joens | 291. BTS-SmoothOneZ |
| 268. BTS-Hot n Steamy | 280. BTS-MaleBasher | 292. BTS-SpaceBoyZ |
| 269. BTS-I Miss U | 281. BTS-MoHappyFeet | 293. BTS-The Ultimate |
| 270. BTS-Iced Out | 282. BTS-MooshooClan | 294. BTS-U4 Got ME |
| 271. BTS-ItsLikeDat | 283. BTS-MounTenbery | 295. BTS-VideoGamez |
| 272. BTS-ItsUAgAln | 284. BTS-My Girl | 296. BTS-While U Werk |
| 273. BTS-KattznJammah | 285. BTS-NWO | 297. BTS-Wide Hive |
| 274. BTS-LaLaZ | 286. BTS-Oh BaebeeZ | 298. BTS-YeaYeaZ |
| 275. BTS-Last Chance | 287. BTS-Play Cousin | 299. BTS-ZMan |
| 276. BTS-Lily 3 | 288. BTS-Q BORO | |

Example Percussion Maps

Hot n Steamy
Factory Preset 009⁰

The following percussion maps will give you a general idea of how most of the percussion instruments are laid out.

Certain drum kits (as in instruments 761-799) have empty keys so that you can insert drums of your own choosing. To insert a new sound onto an empty key, simply layer another drum kit and limit its range to just that key. Use the Transpose function to select which instrument is placed on the empty key.

The preset below shows how percussion instruments and melodic instruments can be combined in one preset using layers

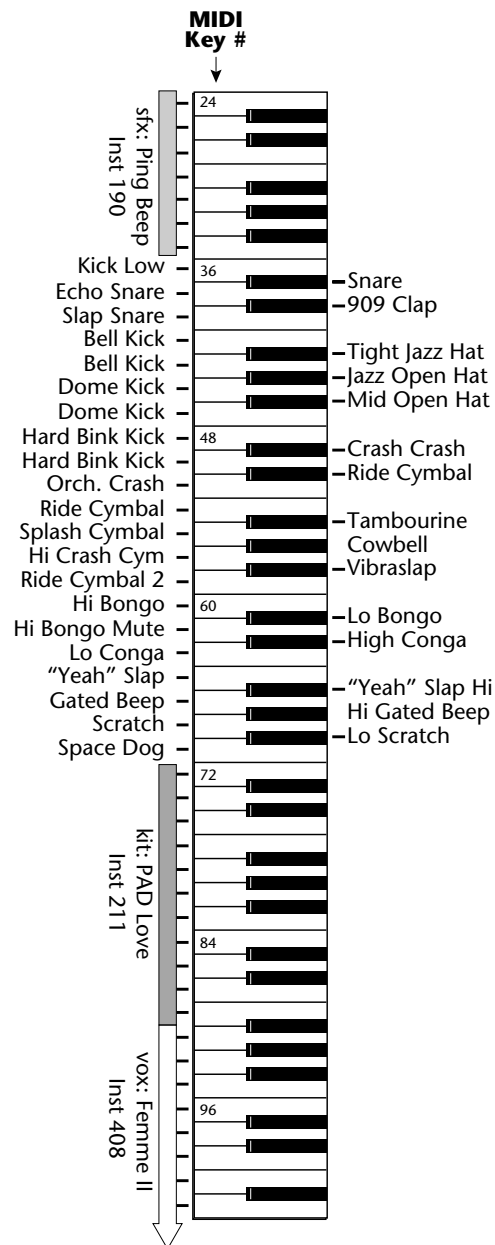

Funky GM 3

Instrument #489

Used in Preset- 109²

Note: All loops are at 83 bpm in this Instrument

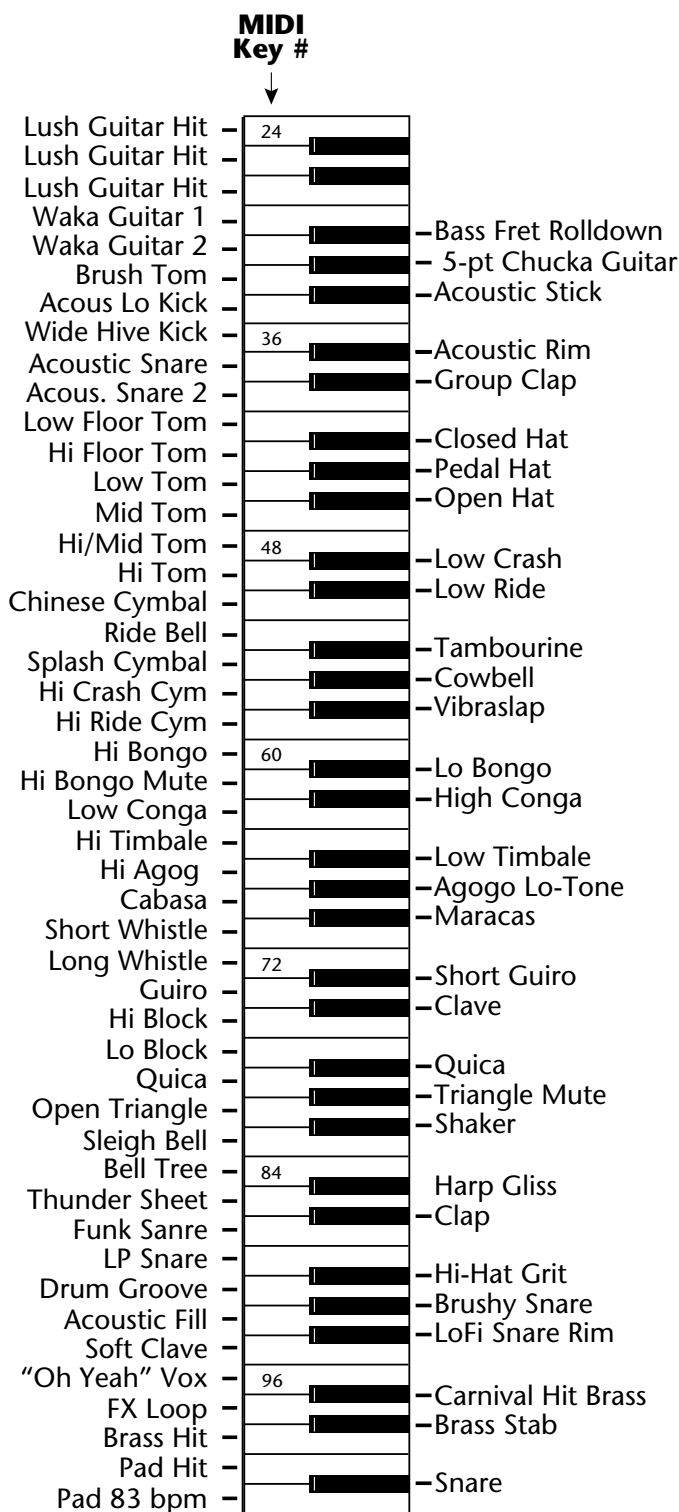

Funky GM One

Instrument # 487

Note: All loops are at 83 bpm in this Instrument

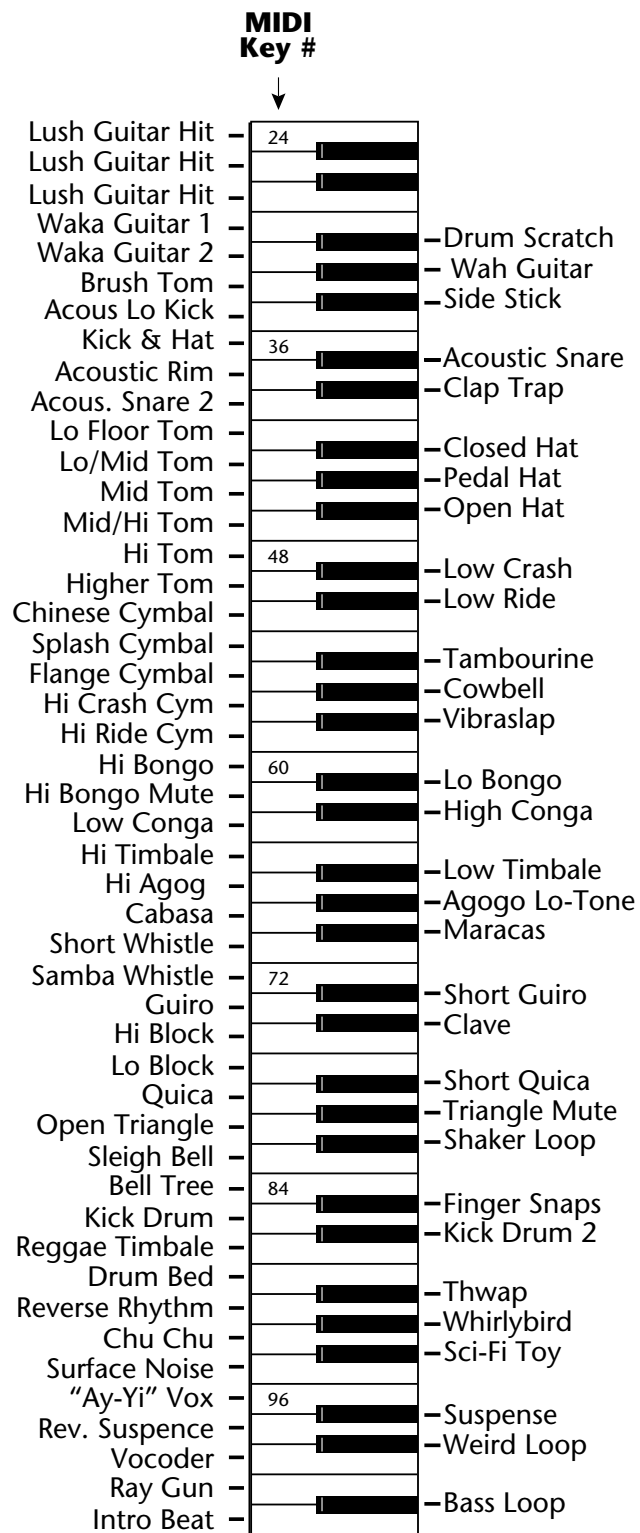

Trigger Layouts

Trigger Layout 1 Setup 59

BEATS trigger layouts are saved when you save a Multisetup. Multisetups 59-62 contain four different BEATS Trigger layouts for you to check out. You may want to design your own trigger layout and when you do, be sure to save it in one of the Multisetup locations.

Note that none of these are write-protected (like the factory multisetup). They are initialized with these layouts, but you are free to overwrite them at will.

Parts 1-8 are set to C⁻² (effectively off). Group 1 & 2 are latched, and Start/Stop & Clear Parts are on the same trigger, so that starting and stopping the sequencer also clears active parts.

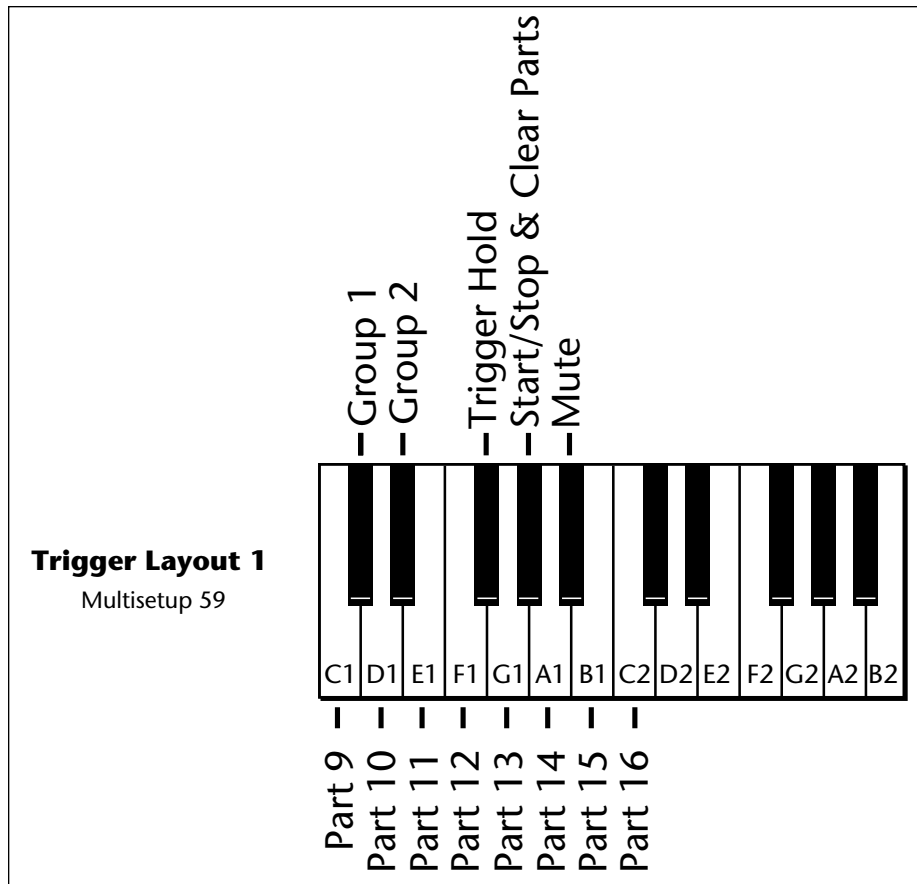

Trigger Layout 2
Setup 60

This layout is similar to the basic layout, except that the groups and functions are on the left of the main triggers. It is setup so that it takes advantage of a 76-key keyboard by starting at E0 instead of C1. However, it can be shifted up to facilitate use on a 61-key keyboard as well.

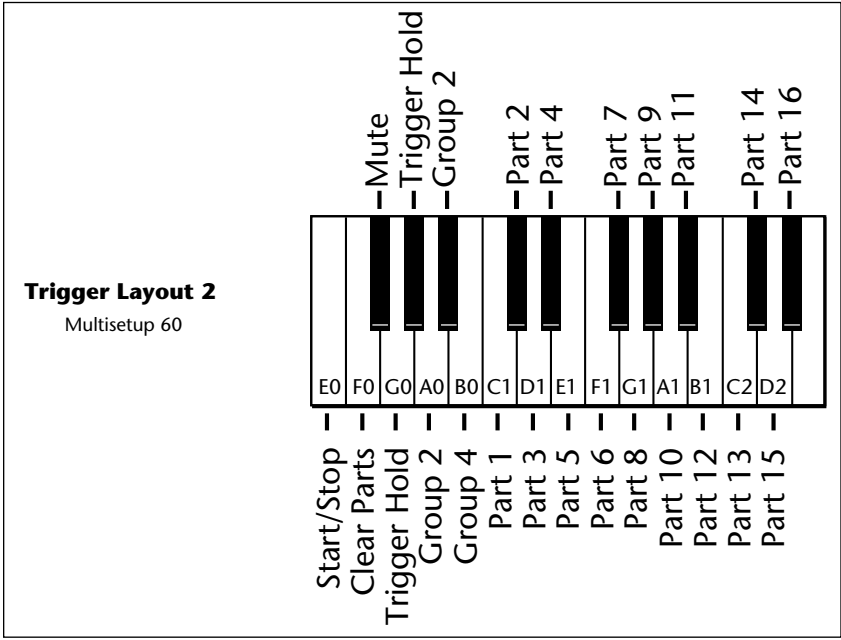

Trigger Layout 3
Setup 61

This layout puts all of the direct part triggers consecutively on the white keys. Groups and functions are put up on the black keys.

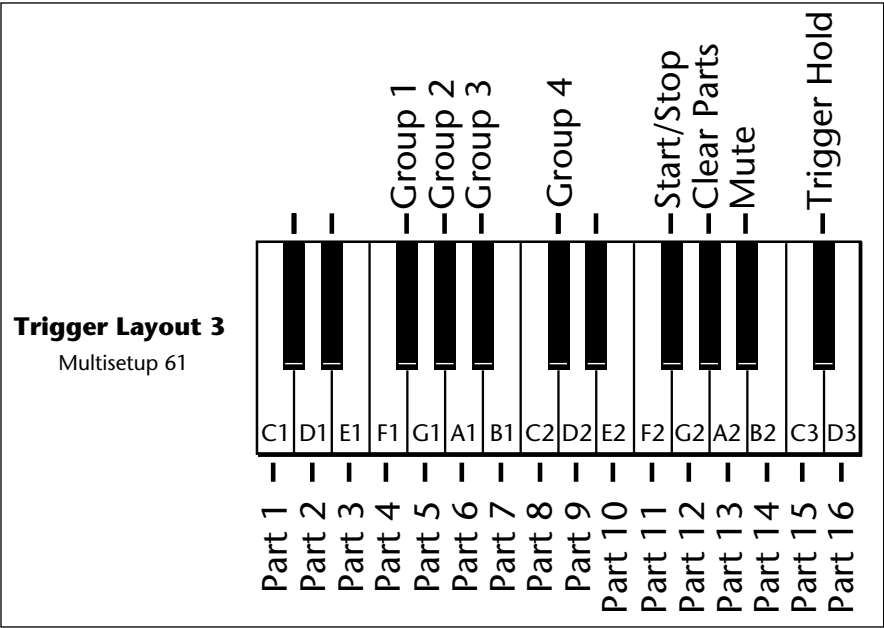

Trigger Layout 4
Setup 62

Parts 1-8 on the first 8 white keys, 9-16 on the first 8 black keys, Groups are on the white keys under parts 14-16, and the Control Functions are on the remaining keys.

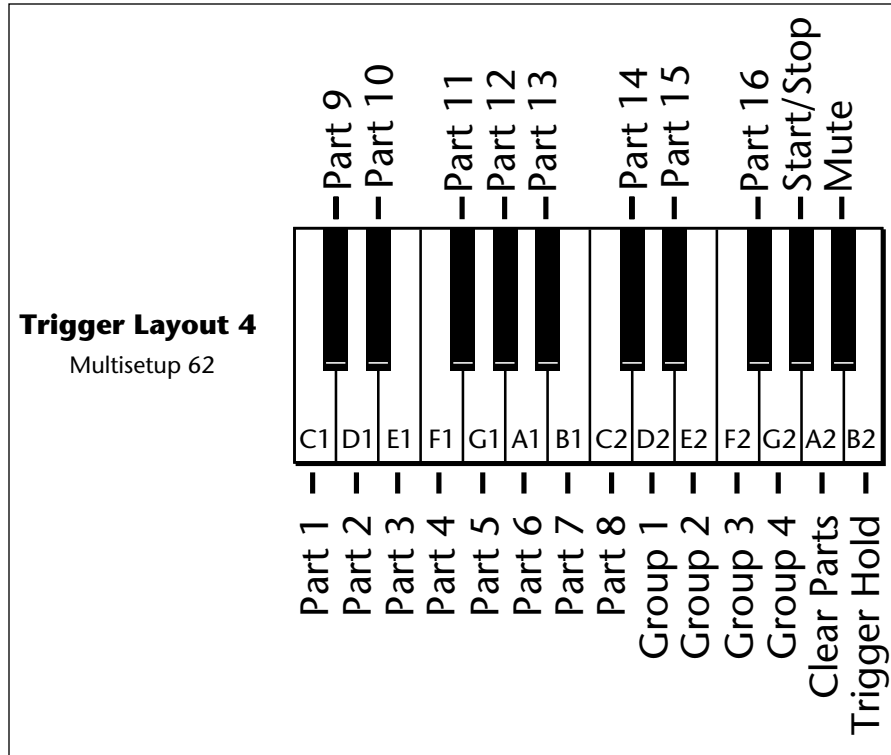

Velocity Curves

This section provides diagrams and descriptions of the Mo'Phatt velocity curves.

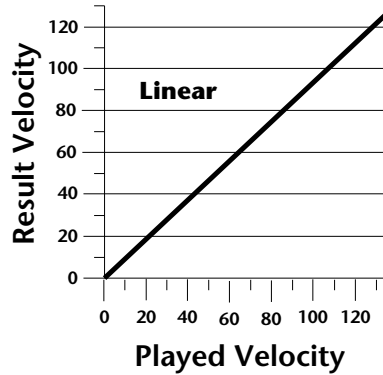

Linear, no change to velocity.

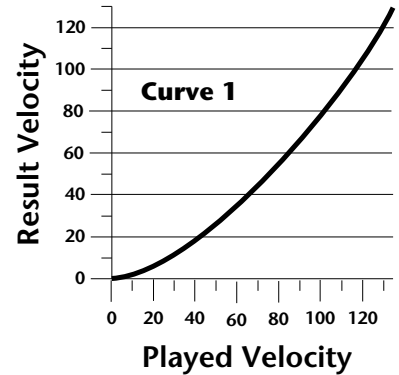

Compresses velocity range.

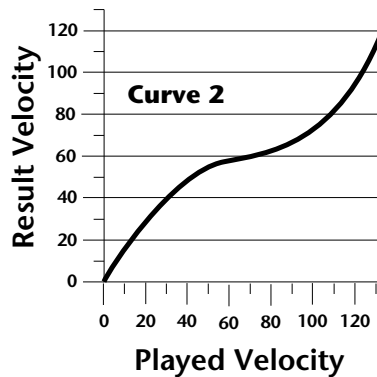

Expands dynamics in low range, emphasizing medium velocity values and compressing high velocity values.

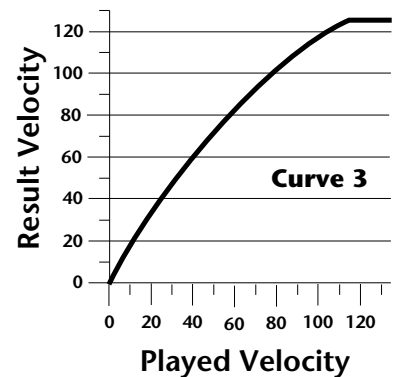

Expands velocity range. Soft -> Loud

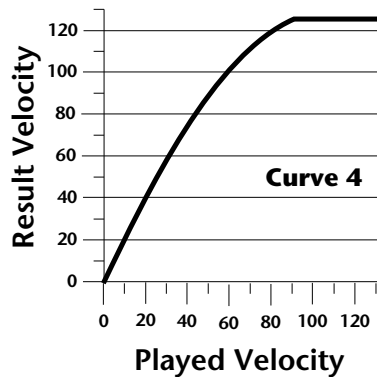

Expands velocity range. Outputs high values.

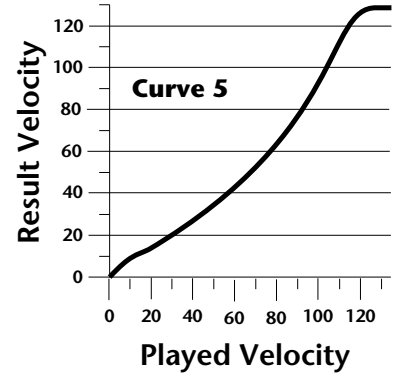

Shifts velocity values upward. Good dynamic range.

Velocity Curves

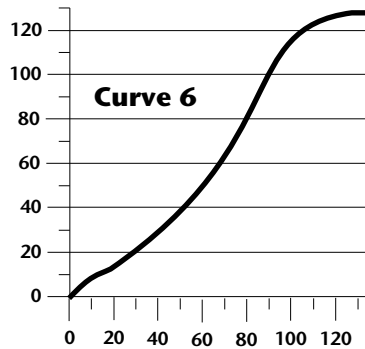

Curve 6
Shifts velocity values up while compressing the middle range.

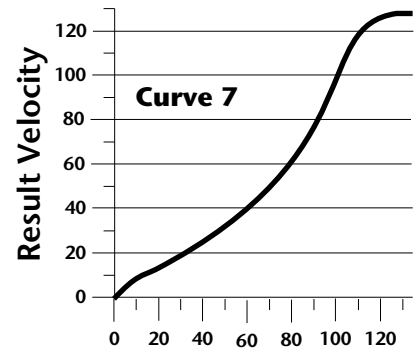

Curve 7
Similar to Curve 6.

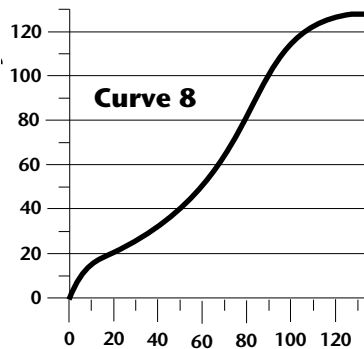

Curve 8
Similar to Curve 6 with more emphasis on the middle range.

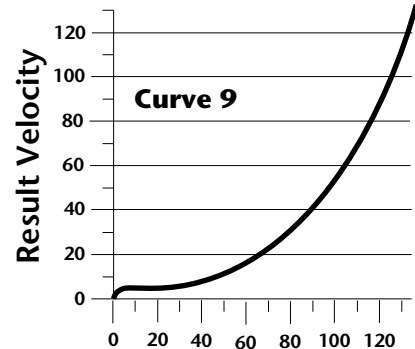

Curve 9
Extreme dynamic range compression.

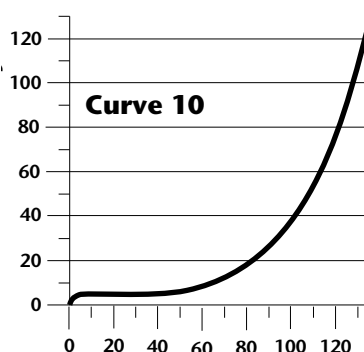

Curve 10
Extreme dynamic range compression. Outputs low values.

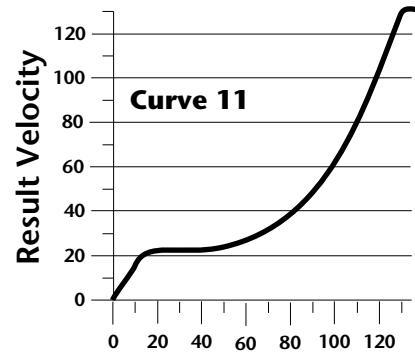

Curve 11
Extreme dynamic range compression but doesn't output low values

PatchCord Amount Chart

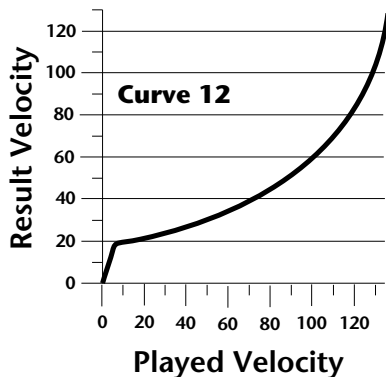

Less severe version of Curve 11.

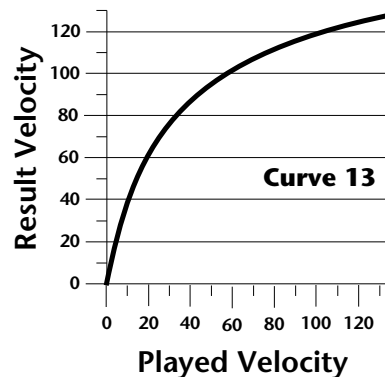

Extreme expansion of velocity range.

The following chart shows the PatchCord “Amount” settings in order to get semitone intervals when modulation sources are connected to pitch.

Semitone	PatchCord Amount	Semitone	PatchCord Amount
1	3	21	66
2	6	22	69
3	approx. 9	23	approx. 72.5
4	approx. 12	24	approx. 76
5	16	25	79
6	19	26	82
7	22	27	88
8	25	28	91
9	28	29	approx. 95
10	approx. 31	30	98
11	35	31	
12	38	32	
13	41	33	
14	44	34	
15	47	35	
16	50	36	
17	approx. 53	37	
18	57	38	
19	60	39	
20	63	40	

MIDI

MIDI Implementation Chart

MIDI Information	Transmitted	Recognized	Remarks
MIDI Channels	---	1-16	
Note Numbers	---	0-127	
Program Change	---	0-127	
Bank Select Response?	No	Yes	MSB + LSB
Modes: Omni (<i>Mode 1</i>)	No	Yes	
Mono (<i>Mode 2</i>)	No	Yes	
Poly (<i>Mode 3</i>)	No	Yes	
Mode 4 (<i>Y/N</i>)	No	No	
Multi (<i>Mode 5</i>)	No	Yes	
Note On Velocity	No	Yes	
Note Off Velocity	No	No	
Channel Aftertouch	No	Yes	
Poly (Key) Aftertouch	No	No	
Pitch Bend	No	Yes	
Active Sensing	No	No	
System Reset	No	No	
Tune Request	No	No	
System Exclusive	Yes	Yes	
Sample Dump Standard	No	No	
File Dump	No	No	
MIDI Tuning	Yes	Yes	
Master Volume	No	Yes	
Master Balance	No	No	
Notation Information	No	No	
Turn GM1 System On	No	No	
Turn GM2 System On	No	No	
Turn GM1 System Off	No	No	
Other (<i>See Remarks</i>)	No	No	
NRPNS	No	No	
RPN 00 (<i>Pitch Bend Sensi.</i>)	No	No	
RPN 01 (<i>Chan. Fine Tune</i>)	No	No	
RPN 02 (<i>Chan Coar. Tune</i>)	No	No	
RPN 03 (<i>Tuning Prog Sel.</i>)	No	No	
RPN 04 (<i>Tuning Bank Sel.</i>)	No	No	
RPN 05 (<i>Mod Depth Rang</i>)	No	No	
MIDI Timing & Sync			
MIDI Clock	No	Yes	
Song Position Pointer	No	No	
Song Select	No	No	
Start	No	Yes	
Continue	No	No	
Stop	No	Yes	

MIDI Information	Transmitted	Recognized	Remarks
MIDI Time Code	No	No	
MIDI Machine Control	No	No	
MIDI Show Control	No	No	
Extension Capability			
General MIDI Compat?	No	No	
Is GM default mode?	No	No	
DLS compatible?	No	No	
Import DLS Files?	No	No	
Export DLS Files?	No	No	
Import stand MIDI files	No	No	
Export stand MIDI files	No	No	
NOTES: Pan: -64 = hard left, +63 = hard right			

Product ID for Mo'Phatt = 0F (15)

MIDI Device Inquiry Responses

Family

MSB 0x04 (Musical Instruments)

LSB 0x04 (ROM Players)

Member

MSB 0x00 (P2k Group)

LSB 0x02 Audity 2000
 0x03 Proteus 2000
 0x04 B-3
 0x05 XL-1
 0x06 Virtuoso 2000
 0x07 Mo'Phatt
 0x08 B-3 Turbo
 0x09 XL-1 Turbo
 0x0A Mo'Phatt Turbo
 0x0B Planet Earth
 0xC Planet Earth Turbo

There is only one edit buffer which is used by the current preset (the preset shown in the display). You can edit only one preset at a time via SysEx commands, although these presets can be edited independently of the current preset edited using the Front Panel. Remote Preset selection is independent of the edit buffer. Changing the current preset erases the edit buffer.

Received Channel Commands

Channels number (n) = 0-15. Message bytes are represented in hex. All other numbers are decimal. Running Status is supported.

Command	Message	Comments
Note Off	8n kk vv	
Note On	9n kk vv	velocity 0 = note off
Key Aftertouch	An kk vv	kk = 0-127 vv = 0-127
Program Change	Cn vv	0-127
Channel Aftertouch	Dn vv	0-127
Pitch Bend	En ll mm	l = lsb, m = msb
Real-time Controller	Bn cc vv	cc = 00-31, 64-95
Footswitch	Bn cc vv	cc = 64-79, vv ≥ 64 = on
Volume	Bn 07 vv	0-127
Pan	Bn 0A vv	0=left, 127=right, 64=center
Expression	Bn 0B vv	reset by multimap selection or "Reset All Controllers"
All Sound Off	Bn 78 00	turns all sound off
Reset All Controllers	Bn 79 00	ignored in omni mode
All Notes Off	Bn 7B 00	ignored in omni mode
Omni Mode Off*	Bn 7C 00	forces all notes & controls off
Omni Mode On*	Bn 7D 00	forces all notes & controls on
Mono Mode On (Poly Off)*	Bn 7E 00	forces all notes & controls off
Poly Mode On (Mono Off)*	Bn 7F 00	forces all notes & controls on
Bank Select MSB	Bn 00 bb	bb = bank MSB (see page 110)
Bank Select LSB	Bn 20 bb	bb = bank LSB (see page 110)

* Special Notes:

- **From Omni Mode** Omni Off turns Poly On.
- **From Poly Mode**..... Omni On turns Omni On; Mono On turns Mono On.
- **From Mono Mode** Mono Off turns Poly On; Omni On turns Omni On.
- **From Multi Mode**..... Omni On turns Omni On; Omni Off or Mono Off turns Poly On; Mono On turns Mono On.
- All other changes have no effect.

SysEx Specification

Mo'Phatt contains an extensive set of MIDI SysEx commands. (*Virtually every parameter is controllable via SysEx.*) Because of the size and technical nature of the System Exclusive specification, it is beyond the scope of this manual. The complete SysEx specification for Mo'Phatt is available on the official E-mu Systems, Inc. web site: www.emu.com

Technical Specifications

Audio Channels:	64
MIDI:	MIDI In, MIDI Out, MIDI Thru
MIDI Channels:	16
Presets:	512 user presets. <i>(The number of ROM presets is determined by the sound SIMMs installed.)</i>
Filters:	6th Order (50 different types)
Audio Outputs:	2 polyphonic analog outputs, 20-bit $\Delta\Sigma$ DACs
Max. Output Level:	+4 dB
Output Impedance:	1000 Ohms
Sound Memory:	32 MB (expandable to 64 MB)
Data Encoding:	16-bit linear data
Effects Engine:	24-bit internal processing
Sample Playback Rate:	44.1 kHz
Signal to Noise:	>92 dB
Dynamic Range:	>90 dB
Frequency Response:	20 Hz - 20 kHz (+2/-1 dB)
THD + Noise:	< 0.02% (1kHz sine wave, A-weighting)
IMD	< 0.05%
Stereo Phase	Phase Coherent +/- 1° at 1 kHz
Power Consumption:	15 Watts
Voltage Input:	90VAC-260VAC at 50Hz-60Hz
Dimensions	H: 1.75 inches W: 19 inches L: 8.5 inches
Weight	6 lb., 14 oz. (3.1 Kg)

Props

Sounds

Fred Zimmerman	Lisa Flores
G.LOW.O.r?m.	Gina Wermuth
Ron E. Beck	Dan Becker
Sam Ward	Kat Ouono
Janis Chaffin	Tim Landis
Mark Blasquez	Michael VonStruble
St. Regis Brothers	

Presets

G.LOW.O.r?m.
Alex Strudley
Andrew Schlesinger
Janis Chaffin
Ed Dickie

Beats & Audition Riffs

Ron E. Beck
Fred Zimmerman
G.LOW.O.r?m.
Sam Ward
Janis Chaffin
Alex Strudley
Mark Coleman
Sean Wilhelmsen

Demo Sequences

GimmeDat - Friday Nite - BONE REQ.....Ron E. Beck
East Meets WestSam Ward
Jenkinz Boyz.....G.LOW.O.r?m.
FredZ Joint.....Fred Zimmerman

Special Thanks

Ben Conrad and the Folks at Wide Hive
E-mu Engineering and SQA
Tim Swartz

Executive Producer

Janis Chaffin

Warranty

Please read this warranty, as it gives you specific legal rights.

Warranty

This product is warranted, to the original consumer purchaser, to be free of all defects in workmanship and materials for a period of one (1) year from the date of such purchase from an authorized EMU dealer, provided that (a) the Warranty Registration Card is filled out and returned to EMU within 14 days of the purchase date, and (b) the EMU service center is provided a copy of the consumer purchaser's sales receipt.

Warranty Restrictions

Specifically, but without limitation, EMU does not provide warranty service for:

- Damages due to improper or inadequate maintenance, accident, abuse, misuse, alteration, unauthorized repairs, tampering, or failure to follow normal operating procedures as outlined in the owner's manual;
- Deterioration or damage of the cabinet;
- Damages occurring during any shipment of the unit;
- Any unit which has been modified by anyone other than EMU.

No other express or implied warranty is made, and EMU specifically disclaims any implied warranty of merchantability, satisfactory quality, and fitness for a particular purpose. EMU's liability under warranty is limited to repair or replacement of the unit, or refund, at EMU's option.

In no event will EMU be liable for loss of revenue or savings, loss of time, interruption of use, or any other consequential, indirect, incidental, special or exemplary damages. The foregoing will apply notwithstanding the failure of essential purpose of any remedy provided herein. Some jurisdictions do not allow the exclusion of implied warranties or conditions, or limitations on how long an implied warranty or condition may last, so the above limitations may not apply. This warranty gives you specific legal rights. You may have other rights which vary from jurisdiction to jurisdiction.

How To Obtain Warranty Service

All EMU products are manufactured with the highest standards of quality. If you find that your unit does require service, it may be done by any authorized EMU service center. If you are unable to locate a service center in your area, please contact EMU's Service Department at (831) 438-1921. They will either refer you to an authorized service center in your area or ask that you return your unit to the EMU factory.

When returning your unit to the EMU factory, you will be issued a Return Merchandise Authorization (RMA) number. Please label all cartons, shipping documents and correspondence with this number. EMU suggests you carefully and securely pack your unit for return to the factory. (Do not send the power cord or operation manual.) Send the unit to E-MU Systems, Inc., 1600 Green Hills Road, Scotts Valley, CA 95066. You must pre-pay shipping charges to EMU; EMU will pay return shipping charges. You will be responsible for any damage or loss sustained during shipment in any direction.

3/99

Index

Symbols

- “+” modulation polarity 143
- “±” modulation polarity 143

Numerics

- 19-tone tuning 153
- 1-bar trigger 43
- 2-pole filters 104
- 4-pole filters 104
- 6-pole filters 104

A

- A effect types 171, 172
- absolute value processor 93
- aftertouch, mono 85
- algorithm
 - FXA 173, 174
 - FXB 173, 175
 - master FXA 70
 - master FXB 71
- all layers 113, 115
- alternate tuning 153
- amount
 - patchcord 108, 142
- amplifier 126
- amplitude 132, 160
- amplitude envelope 127
- amplitude modulation 84
- arp/beats mode 35
- arpeggiate multiple channels 63
- arpeggiator 32
 - channel 32
 - controls 50
 - copying settings 188
 - delay 55, 56
 - duration 61
 - extension 50
 - extension count 54
 - extension interval 54
 - factory patterns 52
 - gate 50
 - gate time 53
 - interval 50
 - key offset 60
 - key range 58

- keyboard thru 57
- latch mode 57
- master parameters 50
- MIDI out 48
- MIDI song start 48, 58
- mode 51
- note value 52, 56
- pattern 49, 52
- pattern naming 62
- pattern speed 52
- resolution 50
- status 51
- sync 55
- user patterns 59
- velocity 50, 53
- arpeggiator modes 49
- assign group 131
- attack, envelope 128, 137, 144, 164
- audition beats 38
- audition button 26
- audition preset 17
- audition riff 156
- auxiliary envelope 87, 137

B

- B effect types 171, 172
- balance 107
- band-pass filter 103, 133
- bandwidth 105
- bank 19
- bank number 19, 30
- bank organization 20
- bank select display 26
- banks
 - selecting 31
- base tempo 36
- basic channel 39
- basic setup 14
- basics, programming 83
- beats
 - busy 41
 - channel 39
 - markers 26, 37
 - mode 35, 39
 - part transpose 45
 - part velocity 44
 - parts group 46
 - riffs 36
 - trigger layouts 43, 216
 - trigger offset 44
 - variation 42
 - velocity group 1-4 41
 - xpose group 1-4 41
- bend range 66
- breath controller 76
- bts
 - preset 20, 40
- bts busy 41

- button
 - control 25
 - cursor 26
 - edit menu 25
 - home/enter 26, 35, 65
 - master menu 25
 - save/copy 26
- bypass effects 176
- C**
- calibration 79
- category
 - instrument 33
 - preset 33
- center frequency 105
- change
 - MIDI preset 75
 - preset 19
- changing
 - filter type 164
 - the voice 157
- channel
 - arpeggiator 32
 - MIDI enable 74
 - MIDI select 30
 - pan 32
 - selection, MIDI 30
 - volume 31
- chorus 171, 181
 - width 159
- chorus, effect 181
- chorusing 129, 159
- clear part 37
- clock
 - divisor 85
 - MIDI 36
- clock modulation 91
- coarse tuning 126, 158
- comb filter 134, 172, 181
- connection instructions 14
- continuous controllers 108
- contour, envelope 85, 128
- control
 - button 25
 - data entry 27
 - effects multi mode 69
 - mode 25
 - rows 25
 - volume 25
- control keys 37
- controller
 - assigning real-time 75
 - footswitch 76
 - knobs 29, 75, 109
 - MIDI 75, 108
 - MIDI #10 32
 - MIDI #7 31, 108
 - MIDI real-time 108
 - modes 27
 - quick edit and real-time mode 28
 - real-time 25, 27
 - only mode 27
 - standardized MIDI numbers 76
- copy preset patchcords 186
- copying
 - layers 185
 - patchcords 186
 - preset banks 188
 - presets 184
- create random preset 190
- credits 226
- crossfade random 86
- crossfade, ranges 122
- current tempo 36
 - offset 156
- cursor buttons 26
- curve
 - velocity 67
 - volume 159
- curve, glide 132
- cutoff frequency 103, 161
- D**
- damping, high frequency 172, 180
- data entry control 27
- DC offset, example 100
- DCA 107, 166
- decay
 - effect A 71, 172
 - effects 172
 - envelope 159
- deep edit mode 28, 78
- default assignment, beats 37
- delay 129
 - arpeggiator 55, 56
 - effect B 72
 - effect processor 182
 - effects 171, 172
 - LFO 140
 - master FXB 72
 - preset link 155
- demo sequences 17
- descending arpeggiator 49
- destinations, modulation 92, 144
- device
 - external MIDI 90
- device ID 73
- dimensions 225
- diode processor 94
- display, viewing angle 82
- distortion effects 171
- distortion, effect processor 182
- double & detune 129, 159
- doubling 181
- downbeat marker 26, 37
- drum mappings 213

- dual channel beats 21, 39
 - dual tap, delay 182
 - duration
 - pattern 61
 - dynamic filters 101
 - dynamic range 225
- E**
- edit menu button 25
 - editing
 - presets 157
 - user patterns 59
 - effect diagram 146, 147, 149
 - effects
 - A type 171
 - B into effect A 178
 - B submix routing 72
 - B type 171
 - busses 169
 - by channel number 178
 - channel number setup 178
 - chorus 181
 - decay 172
 - delay 172, 182
 - description 180
 - distortion 182
 - doubling 181
 - dual tap delay 182
 - feedback 172, 182
 - flanger 181
 - FXA decay 71
 - FXA HF Damping 71
 - FXB feedback 72
 - FxB->FxA 71, 173
 - global 177
 - HF damping 172
 - LFO rate 72, 172
 - master 169, 174, 177
 - A algorithm 70
 - B algorithm 71
 - FxB->FxA 174
 - LFO rate 72
 - mode 69, 176
 - mode, bypass 176
 - multi mode control 69, 176
 - panning delay 182
 - patchcords 151
 - preset 146, 173
 - processor 169
 - programmed in the preset 146, 173
 - reverb 180
 - send amounts 169
 - sends 68, 169
 - slapback 181
 - stereo delay 182
 - submix routing, A 71, 149, 150
 - type A 70, 148, 171, 172
 - type B 72, 149, 171, 172
 - vibrato 182
 - enabling MIDI channels 74
 - enter button 26
 - envelope
 - attack 128, 137, 144
 - auxiliary 137
 - decay 159
 - filter 135, 162, 163, 165
 - generator 85, 87
 - mode, factory 160
 - mode, filter 163
 - release 159
 - repeating 88
 - reverberation 180
 - volume 127, 128, 159, 160
 - envelope generator
 - example 104
 - equal temperament tuning 153
 - errors, data transmission 80
 - expression controller 224
 - extension
 - count 54
 - interval 54
- F**
- factory
 - envelope mode 160
 - factory patterns, arpeggiator 52
 - Fc 135, 161
 - feedback 172
 - effect 182
 - feedback, FXB 72
 - fills, beats 37
 - filter
 - 2-pole 104
 - 4-pole 104
 - 6-pole 104
 - bandpass 103, 133
 - changing type 164
 - comb 134, 172
 - definition 102
 - dynamic 101
 - envelope 87, 135, 162, 163
 - envelope attack 164
 - envelope generator 135, 165
 - envelope mode 163
 - frequency 135, 144, 161
 - high-pass 102, 161
 - low-pass 102
 - mode 163
 - morph 106
 - notch 103
 - overview 161
 - parametric 105
 - pole 104
 - Q 135, 161, 162
 - swept EQ 105
 - troubleshooting 166
 - tutorial 101
 - type 161, 164
 - type, changing 164
 - Z-plane 106, 107, 132
 - fine tuning 126, 158

fingered glide solo mode 131
first key 96
flange effects 171
flanger, effect processor 181
flashing LEDs 26, 37
flip-flop processor 94
footswitch 14, 76, 85
free running, LFO 139
frequency
 center 105
 cutoff 103
 filter 135, 144
frequency modulation 84
front panel knobs 195
FX cords 151
FX mode 69, 176
FXA algorithm 173, 174
FXA parameters 149
FxB -> FxA 173, 174, 178
FxB algorithm 149, 173, 175
FxB master algorithm 71
FxB parameters 150
FxB submix routing 72

G

gain processor 94
gamelan tuning 153
gate 85
gate time 53
generator
 envelope 85
 filter envelope 135, 165
 noise and random 85
 volume envelope 127
glide 132
 curve 132
 key 85
 rate 85, 132
global effects 174, 177
grooves
 beat 37
group, assigning channels to a 131
groups, beats 37

H

headphones 14
high frequency damping 71, 172, 180
high-pass filter 102, 161
home position 19
home/enter button 26, 35, 65

I

ID number
 sysex 73
implementation chart, MIDI 222
initial pan position 126
initial volume 126
instrument 107, 157
 category 33
 listing 201
 selecting 116
instrument listing 201
inverting LFO waves 90

J

just C tuning 153
 description 154
just intonation 153

K

key
 glide 85
 offset, arpeggiator 60
 range, arpeggiator 58
 sync 55
 transpose 125
 trigger 43
 tuning 82
 velocity 85
key range 118
 preset link 155
keyboard
 character assignments 114
 key 85
 layering and splitting 167
 pressure 85
 range 117, 118
 splitting 167
 thru, arpeggiator 57
 transpose 125
 transpose on/off 130
 tuning 153
Kimberger tuning 153
knob
 calibration 79
 typical functions 195
knob preset quick edit 77
knobs
 controller 29, 109
 real-time control 27
 transmit MIDI 27
knobs MIDI out 78

L

- lag processor 93
- lag amount 95
- latch
 - beats part 43
- latch beats 21
- latch keys 37
- latch mode, arpeggiator 57
- layer
 - copying a 185
 - definition 115
 - instrument 83
 - selecting 115
- layering presets 167
- legato 130
- LFO 137
 - effect B 72
 - flanger 182
 - key sync 139
 - master FXB rate 72
 - rate 172
 - rate, effect 72
 - tricks & tips 138
 - trigger 90
 - variation 141
 - waveforms 89
 - waveshape 138
- linking presets 155, 156, 167
- looping envelopes 88
- low frequency oscillator 85, 89, 137
 - delay 140
 - free running 139
 - sync 137, 139
 - variation 141
- low-pass filter 102
- low-pass filter, example 104

M

- main screen 30, 35, 65
- master
 - arpeggiator 22
 - arpeggiator parameters 50
 - bend range 66
 - clock
 - current tempo 36
 - modulation 90
 - effects 169, 174, 177
 - FXA algorithm 70
 - FXB algorithm 71
 - menu 65
 - menu button 25
 - riff 39, 46
 - tuning 66
- melody solo mode
 - (high) 130
 - (last) 130
 - (low) 130
- menu
 - master 65

- save/copy 183
- MIDI 77
 - A-H messages 27
 - bank select display 17, 26
 - channel selection 30
 - clock 36
 - continuous controllers 75, 85, 108
 - controller #7 31
 - device ID 73
 - enable 74
 - external clock 90
 - footswitches 76
 - implementation chart 222
 - in 14
 - inputs A & B 15
 - knobs transmit 27, 78
 - mode 34, 73, 169
 - multi mode 73
 - omni mode 73
 - out 15
 - out, arp/beats 48
 - pan control #10 32
 - poly mode 73
 - real-time controllers 108
 - receive program change 75
 - received channel commands 224
 - receiving sysex data 81
 - recording sysex data 81
 - send sysex data 81
 - song start 48, 58
 - standardized controller numbers 76
 - sync 48
 - sysex data, sending 80
 - sysex packet delay 80
 - transmit, knob 78
- MIDI sysex
 - send/receive 81
- minimoog, solo mode 131
- mix output 145, 170
- mod wheel 85
- mode
 - arpeggiator 51
 - arpeggiator latch 57
 - control 25
 - controller 27
 - deep edit 78
 - effect bypass 176
 - factory 160
 - filter envelope 163
 - latch 57
 - MIDI 73, 169
 - mono 224
 - multi 73, 169, 224
 - non-transpose 130
 - omni 73, 176, 224
 - poly 73, 176, 224
 - quick edit & real-time controller 28
 - real-time controllers only 27
 - solo 130
 - time-based 163
- modulation
 - amplitude 84

- clock 91
 - destinations 92
 - note-on 92
 - polarity 143
 - processors 93, 97
 - random 86
 - routing 142
 - sources 85, 86
 - sources & destinations 144
 - wheel 76
 - modulation, definition 84
 - mono aftertouch 85
 - mono A-I, assign group 131
 - mono mode 224
 - morph filter 106
 - multi channel arp 23
 - multi mode 73, 169, 224
 - control, effects 176
 - effects control 69
 - multimode map
 - send/receive 80
 - multiple arpeggiators 63
 - multiple trigger solo mode 130
 - multisetup
 - saving 190
 - send/receive 80
 - multitimbral operation 34
 - mute beats 37
- N**
- naming a user pattern 62
 - naming, preset 114
 - noise & random generators 85
 - non-transpose mode 130
 - notch filter 103
 - note value
 - arpeggiator 52, 56
 - note-on modulation 92
- O**
- offset, arpeggiator key 60
 - omni mode 73, 176, 224
 - output
 - headphones 14
 - jack 14, 15
 - mix 145, 170
 - mono 14, 15
 - routing 145
 - overall tuning, adjusting 66
- P**
- packet delay, MIDI sysex 80
 - pan 107
 - channel 32
 - initial 126
 - preset link 155
 - pan control 32
 - panning delay, effect 182
 - panning L/R 32
 - parameters
 - effects 171
 - parametric filters 105
 - part, beat 37
 - patchcord 86, 142
 - amount 108, 142
 - copying a 186
 - example 97
 - routing 92
 - pattern
 - arpeggiator 49, 52, 59
 - duration 61
 - naming 62
 - repeat 61
 - speed 52
 - velocity 61
 - pedal 85
 - percussion maps 213
 - performance controllers 85
 - pink noise, example 99
 - pitch wheel 85, 165
 - master bend range 66
 - pitch, shifting 158
 - pitchbend range 145
 - play solo layers 156
 - polarity, modulation & LFO 143
 - polarity, ramp rate 96
 - pole filters 104
 - poly all, assign group 131
 - poly mode 73, 176, 224
 - portamento 132
 - power 16
 - power consumption 225
 - preset
 - architecture 115
 - audition 17, 26
 - category 19, 33, 196
 - changing 19
 - copying 184
 - editing 157
 - effects 146, 173
 - lag 95
 - links 155, 156, 167
 - listing 197, 201
 - MIDI changes 75
 - naming 114
 - quick edit 77
 - random 190
 - saving a 183

- selecting 18, 30
- user 81
- preset ramp 95
- processor
 - 4x gain 94
 - absolute value 93
 - diode 94
 - effect 169
 - flip-flop 94
 - modulation 97
 - quantizer 94
 - summing amp 93
 - switch 93
- product description 1
- product ID 223
- program change, receive 75
- program/preset map
 - send/receive 80
- program->preset map 74
- programming basics 83
- props 226

Q

- Q 103, 134, 135, 161, 162, 164
- quantized 55
- quantizer 94, 100
 - example 99
- quarter note marker 26, 37
- quick edit 28
 - preset 77

R

- ramp rate 96
- random
 - creating presets 190
 - crossfade 86
 - crossswitch 123
 - generator, noise and 85
- random modulation sources 86
- range
 - arpeggiator key 58
 - extension count 54
 - key 117, 118
 - keyboard 117
 - pitchbend 145
 - velocity 120
- rate
 - effect LFO 72, 172
 - glide 132
 - LFO 139
- rate, master FXB LFO 72
- rate/level envelopes 87
- real-time control of arps 50
- real-time controller 25, 27, 108
 - assignment 75
 - crossfading 122
 - mode, quick edit and 28

- real-time crossfade 122
- receive program change 75
- received channel commands, MIDI 224
- receiving & recording MIDI SysEx data 81
- rectifier 93
- release velocity 85
- release, envelope 159
- renaming an arpeggiator pattern 62
- repeat
 - arpeggiator pattern 61
 - pattern 61
- resonance 103, 134, 135, 162, 164
- reverb 171, 180
- reverb, envelope 180
- riff
 - assignment 156
 - beat marker 26, 37
 - controllers 47
 - listing 210
 - loop marker 26, 37
 - MIDI out 78
 - playing 17, 26
 - tempo 47
- ROM card identifier 18
- routing
 - FXA & FXB submix 71, 72, 149, 150
 - modulation 142
 - output 145

S

- safety instructions 3
- save
 - arp/beats 35
- save/copy button 26
- save/copy menu 183
- saving presets 183
- Scarlati tuning 153
- screen
 - main 30, 35, 65
 - preset select 30
- screen viewing angle 82
- selecting a MIDI channel 30
- selecting presets 18, 30
- send
 - preset effect 145
- send amount
 - FXA 71, 149, 150
- send amounts 169
- sends
 - effect 68
- sequence
 - using multisetups in a 188
- setup
 - basic 14
 - studio 15
- signal path 107, 169
- slapback 181

- slapback, effect 181
 - solo layer 156
 - solo mode 130
 - song start, MIDI 48, 58
 - sound navigator 33
 - selecting instruments 116
 - sound start 129
 - sources, modulation 144
 - specifications, technical 225
 - split
 - keyboard 155
 - splitting the keyboard 167
 - using links 167
 - stack
 - layers 119
 - presets 155
 - standard MIDI switch numbers 77
 - standardized MIDI controller numbers 76
 - start/stop groove 37
 - status, arpeggiator 51
 - step-by-step instructions 157
 - stereo delay, effect 182
 - stolen voices 131
 - studio setup 15
 - submix routing
 - FXB 72
 - summing amp processor 93
 - summing nodes 84
 - superbeats 35, 36
 - definition 36
 - swept EQ filter 105
 - switch
 - mod processor 93
 - switch processor 93, 97
 - sync
 - arpeggiator 55
 - key 55
 - LFO 137, 139
 - MIDI song start 48
 - synth solo mode
 - (high) 131
 - (last) 130
 - (low) 131
 - sysex
 - packet delay 80
 - system exclusive
 - device ID 73
 - ID 73
 - send data 81
- T**
- tap tempo 36
 - technical specifications 225
 - tempo offset 156
 - tempo-based 127, 160
 - tempo-based envelope 88, 136
 - time
 - arpeggiator gate 53
 - master FXB delay 72
 - time based envelope 87
 - time-based 127, 160, 163
 - time-based envelope 136
 - transmission errors 80
 - transmit MIDI, knob 78
 - transpose 66, 125, 126
 - arpeggiator 54
 - preset link 155
 - transpose, part 45
 - trigger channel 39
 - trigger key 37
 - trigger keys 21
 - trigger layouts 216
 - trighold 38
 - troubleshooting, filter 166
 - tune 66
 - tuning 126, 158
 - 19-tone 153
 - coarse 158
 - equal temperament 153
 - fine 158
 - gamelan 153
 - just C 153
 - key 82
 - keyboard 153
 - vallotti 153
 - tuning tables
 - send/receive 80
 - tutorial, filter 101
 - tutorial, programming 157
- U**
- unlatch beats part 43
 - user
 - presets 81
 - user key tuning 82
 - user pattern
 - arpeggiator 59
 - naming 62
 - repeat 61
 - velocity 61
- V**
- Vallotti tuning 153
 - variation, LFO 141
 - velocity
 - arpeggiator 53
 - crossfade 120
 - curve 67, 219
 - key 85
 - preset link 155
 - release 85
 - user pattern 61
 - vibrato, effect processor 182

viewing angle, screen 82
voices
 changing 157
voices, stolen 131
voltage setting 16
volume
 control 25
 control #7 31
 curve 159
 envelope 107, 127, 128, 159, 160
 preset link 155
volume envelope 87
volume, channel 31
volume, initial 126

W

waveforms
 inverting 90
 LFO 89
weight 225
Werkmeister tuning 153
wheel
 modulation 76, 85
 pitch 85, 165
width, chorus 159

X

X-factor (transpose) 45

Z

Z-plane filter 106, 107, 132

Notes