

Instruction manual

Fusion Splicer **70S**



Please read this instruction manual carefully before operating the equipment.

Adhere to all safety instructions and warnings contained in this manual.

Keep this manual in a safe place.

There is a change without a previous notice.

We are not responsible for the products which are not purchased from our authorized distributors.

Please consent beforehand.

The software equipped in splicer and its related documents are protected by copyright laws and international treaty provisions as well as other intellectual property laws.

Copying some or all of instruction manual without notice is forbidden. Moreover, without permission from our company, it cannot use on the Copyright Act except that it uses as an individual.

---Caution for Air Transport---

*This product contains Lithium Ion Battery.
When shipping this product, please inform the transport company that this product contains the lithium ion battery before shipping.
Please follow the direction of the transport company.*

Do not take the protector off the splicer, or consult with the authorized distributor for instruction. Tightening the original screw without the protector may damage mechanism inside.



Environmental performance decreases when the protector is detached.

Safety Information	1
General information	6
Introduction	6
New function of 70S	7
Description of Product	8
Components of Splicer	8
Other Necessary Items for Splicing Operation	9
Description and Function of Splicer	10
Operation of Sheet Key	12
Basic Operation	13
Splicing work preparation	13
Power Supply	15
DC operation with external battery	17
Battery Operation	18
Turning Splicer ON/OFF	21
Up/Down Key function.....	22
Splicer Settings Check	23
Change of the Operation Mode	24
Change of the Splice Mode	25
Change of the Heater Mode	27
Preparation of fiber.....	29
Arc Calibration	34
Splicing procedure	36
Storing splicing results	40
How to input Mode Title/Comment/Password	40
Fiber Proof Test.....	41
Heating protection sleeve.....	41
Maintenance of Splicing Quality	43
Cleaning and Checking before Splicing.....	43
Periodical Checking and Cleaning.....	45
Cautions were displayed	46

<i>Splice Menu</i>	48
Composition of Splice Menu.....	48
Splice Mode	49
Select Splice Mode	50
Manual Splice Mode.....	59
ECF Splice.....	60
Splice Settings	62
Memory.....	63
Camera Image	65
Splice Memory Comment.....	66
<i>Heater Menu</i>	67
Select Heater Mode	67
About heating of a connector splice part	70
<i>Maintenance</i>	71
Maintenance Menu information	71
Replace Electrodes	72
Stabilize Electrodes.....	73
Clear Arc Count.....	73
Clear Cleaver Counter	74
Motor Drive	74
Diagnostic Test.....	75
Dust Check	76
Arc Calibration	77
Motor Calibration.....	79
Maintenance Info.....	79
Machine Settings.....	80
Supervisor Menu	81
<i>Error Message List</i>	82
<i>Questions and Troubleshooting</i>	88
Power Supply.....	88
Splicing Operation.....	89
Tube-heating Operation	91
Supervising	91
Other Functions	92
<i>Guarantee and Contact Address</i>	93
Guarantee	93
Contact Address.....	94

The splicer has been designed for splicing Silica-based optical fibers for telecommunications. Do not attempt to use this machine for other applications.

Fujikura Ltd. gives much consideration and regard to personal injury. Misuse of the machine may result in electric shock, fire and/or serious personal injury.

Follow all safety instructions

Read and understand all safety instructions.

Stop using it when it malfunctions

Ask our service centers for repair as soon as possible.

Instruction Manual

Read this instruction manual carefully before operating this machine. Store this instruction manual in a safe place.

The following alert symbols are used in this instruction manual and machine to indicate warnings and caution for safe use. Understand the meanings of these symbols.



WARNING!

There is a possibility of death or serious injury resulting from improper use by ignoring this indication.



CAUTION!

There is a possibility of personal injury or physical loss resulting from improper use by ignoring this indication.

Symbol means "Pay attention"



Pay attention to hot surface!

Symbol means "Must not do"



You must not disassemble!

Symbol means "Must do"



You must disconnect a plug!



WARNINGS!

Disconnect the AC power cord from the AC adapter inlet or the wall socket (outlet) immediately if user observes the following or if the splicer receives the following faults:

- Fumes, bad smell, noise, or over-heat occurs.
- Liquid or foreign matter falls into cabinet.
- Splicer is damaged or dropped.



If this occurs, ask our service center for repair. Leaving the splicer in a damaged state may cause equipment failure, electric shock or fire and may result in personal injury, death or fire.



AC adapter which be used for a splicer is only an adapter for exclusive use.

Using an improper AC power source may cause fuming, electric shock or equipment damage and may result in personal injury, death or fire.



Use the supplied AC power cord. Do not place heavy objects on the AC power cord.

Use of an improper cord or a damaged cord may cause fuming, electric shock or equipment damage and may result in personal injury, death or fire.



Do not disassemble or modify the splicer, AC adapter or battery. In particular, do not remove or bypass any electrical or mechanical device (e.g. a fuse or safety switch) incorporated into the design and manufacturing of this equipment. Modification could cause damage that may result in personal injury, death, electric shock or fire.



Never operate the splicer in an environment where flammable liquids or vapors exist.

Risk of dangerous fire or explosion could result from the splicer's electrical arc in such an environment.



Do not use compressed gas or canned air to clean the splicer. They may contain flammable materials that could ignite during the electrical discharge.



Do not touch the electrodes when the splicer is on and power is supplied to the unit. The electrodes generate high voltage and high temperatures that may cause a severe shock or burn.

Note Arc discharge stops when wind-protector is opened. Turn the splicer off and disconnect the AC power cord before replacing electrodes.



Safety glasses should always be worn during fiber preparation and splicing operation.

Fiber fragments can be extremely dangerous if it comes into contact with the eye, skin, or is ingested.



WARNINGS!

Use only proper power source.

- Proper AC power source is AC100-240V, 50-60Hz. Check the AC power source before use. Proper DC power source is DC10-12V. Improper AC or DC power source may cause fuming, electric shock or equipment damage and may result in personal injury, death or fire.
- AC generators commonly produce abnormally high AC output voltage or irregular frequencies. Measure the output AC voltage with a circuit tester before connecting the AC power cord. Such abnormally high voltage or frequency from a generator may cause fuming, electric shock or equipment damage and may result in personal injury, death or fire. Make sure the generator is regularly checked and serviced.
- An AC adapter Protection Circuit is included in the AC adapter. If the “High AC Input” lamp of the AC adapter is lit or the protection circuit in the AC adapter is tripped, this indicates that the incoming voltage is dangerously high and may cause injury or damage to the equipment, as mentioned above. When using an AC generator with AC output voltage of AC220-240V especially, Fujikura Ltd. recommends the following measures to correct the condition.
 1. Connect a step-down transformer between the generator and the AC adapter in order to lower the AC voltage from AC220-240V to AC100-120V.
 2. Or, use an AC generator with AC output voltage of AC100V.
 3. Or, use an AC generator that has an inverter circuit to stabilize the output.



Do not modify, abuse, heat or excessively pull on the supplied AC cord. The use of a damaged cord may cause fuming, electric shock or equipment damage and may result in personal injury, death or fire.



The splicer uses a three-prong (core) AC cord that contains an earthed ground safety mechanism. The splicer **MUST** be Grounded. Use only the supplied three-prong (core) AC power cord. **NEVER** use a two-prong (core) power cord, extension cable or plug.



Connect AC power cord properly to the splicer (inlet) and wall socket (outlet). When inserting the AC plug, make sure there is no dust or dirt on the terminals. Engage by pressing the female plug into the splicer (inlet) and the male plug into the wall socket (outlet) until both plugs are fully seated. Incomplete engagement may cause fuming, electric shock or equipment damage and may result in personal injury, death or fire.



Do not short-circuit the terminals of AC adapter and optional battery. Excessive electrical current may cause personal injury due to fumes, electric shock and equipment damage.



WARNINGS!



Do not touch the splicer, AC power cord and AC plugs with wet hands. This may result in electric shock.



Do not operate splicer near hot objects, in hot temperature environments, in dusty / humid atmospheres or when water-condensation is present on the splicer. This may result in electric shock, splicer malfunction or poor splicing performance.



When using optional battery, follow the instructions below.

Failure to follow these may result in explosion or personal injury.

- Do not charge battery with other methods than instructed.
- Do not discard battery into an incinerator or fire.
- Do not charge or discharge battery near a flame or under direct sunlight.
- Do not excessively shake or jar the battery.
- If battery leaks of liquid residue, be careful handling the battery so the liquid does not get in skin or eye contact. If it reaches contact, immediately wash skin or eyes thoroughly and see the doctor. Dispose of the battery and call the service center for replacement.
- Do not stack battery on top of AC adapter while charging.
- If charge did not complete in five hours or the "CHARGE" LED does not turn ON, immediately stop charging and call the service center for repair.



When transporting the carrying case using the shoulder belt, check the belt and hooks for damage before use. Carrying the case with a damaged shoulder belt may cause the belt to break or come off and result in personal injury or equipment damage.



CAUTIONS!



Do not store splicer in any area where temperature and humidity are extremely high. Possible equipment failure may result.



Do not touch protection sleeve or tube-heater during heating or immediately after completion of heating. Their surfaces are very hot and touching these may result in skin burn.



Do not place the splicer in an unstable or unbalanced position. The splicer may shift or lose balance, causing the unit to fall. Possible personal injury or equipment damage may result.



The splicer is precision adjusted and aligned. Do not allow the unit to receive a strong shock or impact. Possible equipment failure may result. Use supplied carrying case for transportation and storage. The carrying case protects the splicer from damage, moisture, vibration and shock during storage and transportation.



CAUTIONS!

Follow the below listed instructions for handling electrodes.



- Use only specified electrodes.
- Set the new electrodes in the correct position.
- Replace the electrodes as a pair.

Failure to follow the above instructions may cause abnormal arc discharge. It can result in equipment damage or degradation in splicing performance.



Do not use any chemical other than pure alcohol (99% or greater) to clean the objective lens, V-groove, mirror, LCD monitor, etc., of the splicer. Otherwise blurring, discoloration, damage or deterioration may result.



The splicer requires no lubrication. Oil or grease may degrade the splicing performance and damage the splicer.



The equipment must be repaired or adjusted by a qualified technician or engineer. Incorrect repair may cause fire or electric shock. Should any problems arise, please contact the authorized distributor.

RECYCLING and DISPOSAL

In European Union



In accordance with the European Parliament Directive 2002/96/EC, electrical parts and materials that can be re-used and/or recycled have been identified in order that the use of new resources and the amount of waste going for landfill can be minimised.

In the European Union, do not discard this product as unsorted municipal waste. Contact your local authorities.

In other countries

[Recycling]

To recycle this product, disassemble it first, sort each part separately by material components and follow your local recycling regulations.

[Disposal]

This product can be disposed of same as the standard electric products. Follow your local disposal regulations.

Introduction

This fusion splicer 70S is a fusion splicer which can connect a single optical fiber. Moreover, a new function was added and made the 70S splicer much improved in versatility. In order to master 70S, please read this instruction manual.



Splice mode

The 70S has not only standard splice modes, but also automatic modes, AUTO mode. The AUTO mode consists of [SM AUTO], [MM AUTO], [NZ AUTO], [DS AUTO] mode. When using AUTO mode, the automatic arc calibration function is enabled.

The standard modes consists of [SM] for SMF (ITU-T G652), [NZ] for NZDSF (ITU-T G655), [DS] for DSF (ITU-T G653) and [MM] for MMF (ITU-T G651). This mode requires executing [Arc Calibration] before splicing.

Automatic arc calibration function

This function calibrates the arc power at every splice. When the automatic arc calibration function is enabled, performing the [Arc calibration] function before a splice operation is not necessary. The automatic arc calibration function works in AUTO modes only. It doesn't work in the standard splice modes. When using those modes, performing [Arc calibration] before splicing is strongly recommended.

New function of 70S

Automatically wind-protector

Wind-protector at the time of splicer work is operated automatically.

The wind-protector operation after the end of work can be changed by choosing the mode which wind-protector opens and closes.

New Heating system

If a protection sleeve is set, a lid will close automatically and it will start heating work.

Corresponds to connector splice

The connection of a field assembly optical connector by heating of a protection sleeve can be performed by a 70S.

Moreover, versatility is improved by portability.

Corresponds to Short length splice

In addition to the standard splice, splice of 5-mm interference also recently became possible.



➤ A specialized tool is needed in order to perform 5-mm prepared.

Cleaver Counter

The use situation of the optical fiber cleaver currently used for splice is displayed, and alarms, such as change of a cutting position and change of edge quantity, are displayed by a splicer on a plane. The large cleave angle and cleave shape NG at the time of fiber cutting, aggravation of a splice loss, etc. can be prevented in advance.

The optical fiber cleaver currently used when an alarm screen is displayed is adjusted.

Using of work tray

The work tray can be used immediately when removed from the inside of a main part storage carrying case can be used.

Moreover, the carrying case can be used as a working table.

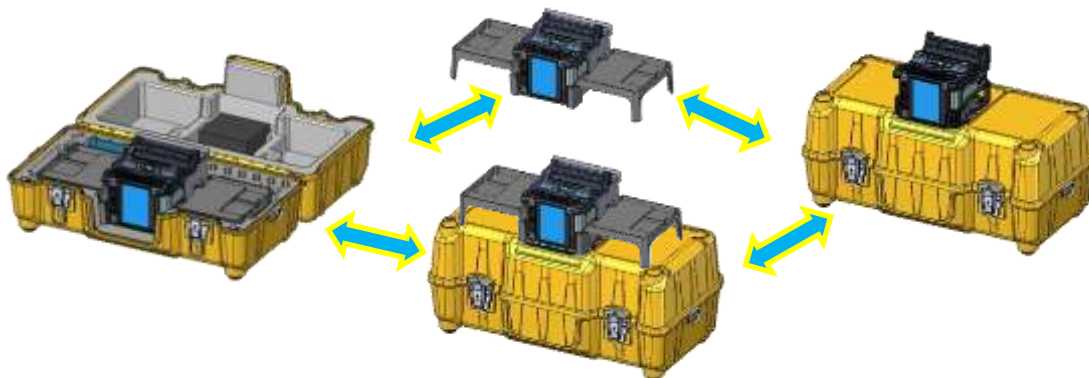

Upgrade of software





The software of 70S is upgradable from on the Internet. Please install Data Connection in attached CD manual.

Components of Splicer

Standard Equipment







The standard equipment of the splicer is the following. Check the equipment items mentioned of list.

Standard Package List.

	<i>Fusion Splicer [70S]</i>		<i>Carrying Case [CC-30]</i>		
	<i>AC adapter [ADC-18]</i>		<i>AC cord [ACC-**]</i>		
	<i>Instruction Manual [M-70]</i>		<i>USB Cable [USB-01]</i>		<i>Alcohol Pot [AP-01]</i>
	<i>Spare Electrodes [ELCT2-20A]</i>		<i>Quick Reference Guide [Q-70S-E]</i>		<i>Warning and Caution [W-70-E]</i>

Other Necessary Items for Splicing Operation

Tools

Fiber coating diameter	UV Coating 0.25mm	Ny Coating 0.9mm
Fiber protection sleeves	<u>Standard sleeve</u> 60mm length [FP-03] 40mm length [FP-03 (L = 40)]	
	<u>Micro sleeve</u> 15mm length [FPS01-400-15]	<u>Micro sleeve</u> 20mm length [FPS01-900-20]
Fiber stripping tools	Primary coat stripper [PS-02] 	Jacket stripper [JS-01] 
Fiber Holder (Option)	Fiber Holder [FH-60-250] 	Fiber Holder [FH-60-900] 
Fiber cleaving tools	Fiber Cleaver [CT-30]	
Fiber cleaning tools	Alcohol Pot [AP-01] with alcohol (purity > 99%) Lint-free tissue or gauze	

Description and Function of Splicer structure

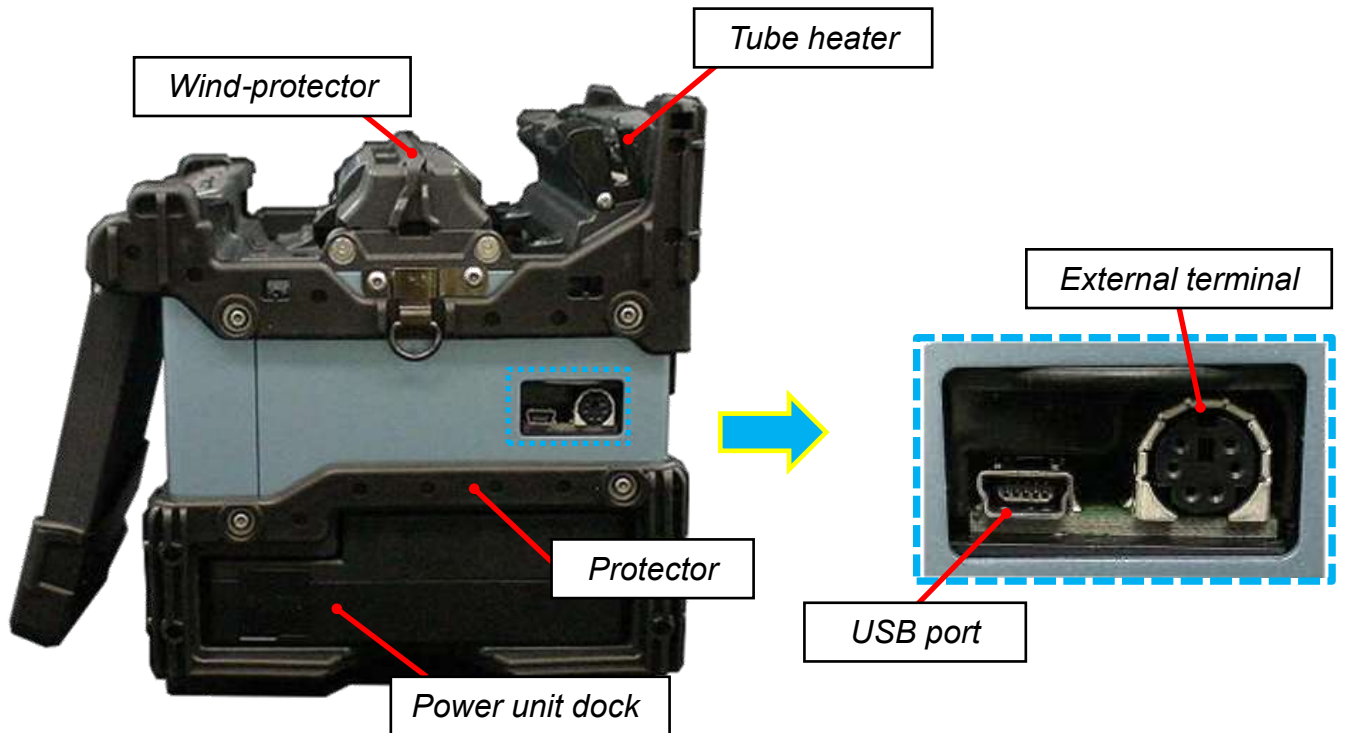

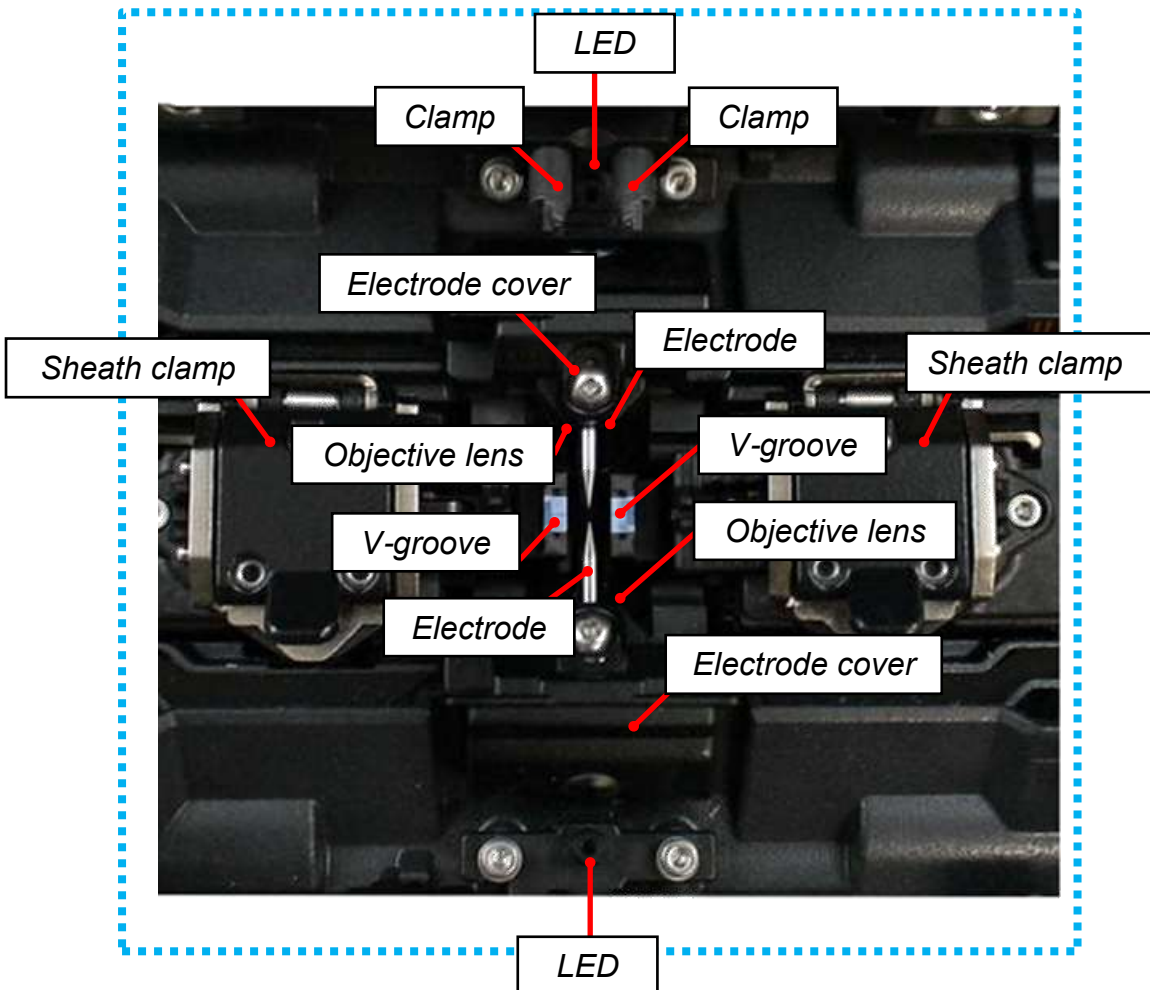
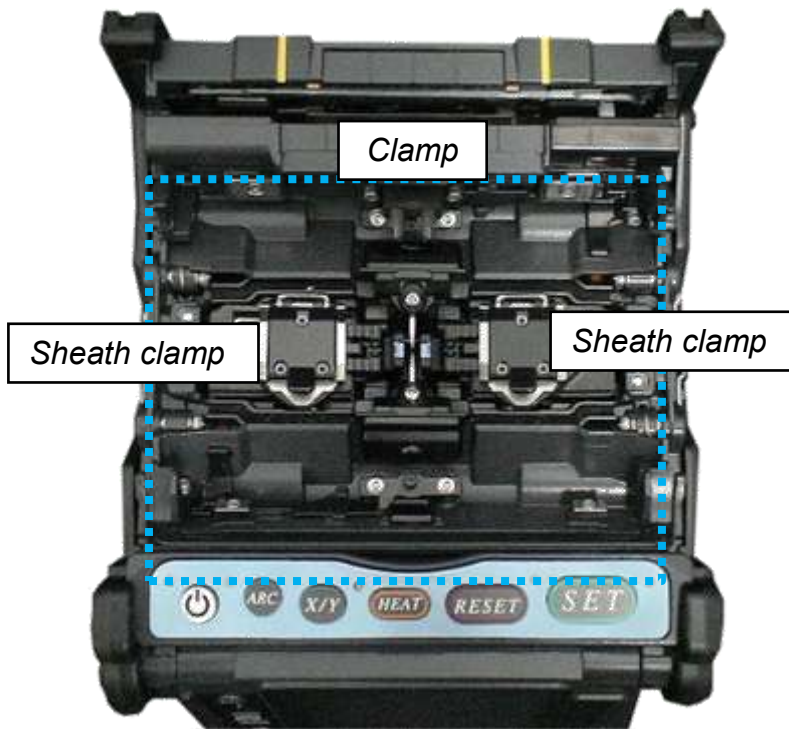

Operation of Sheet Key

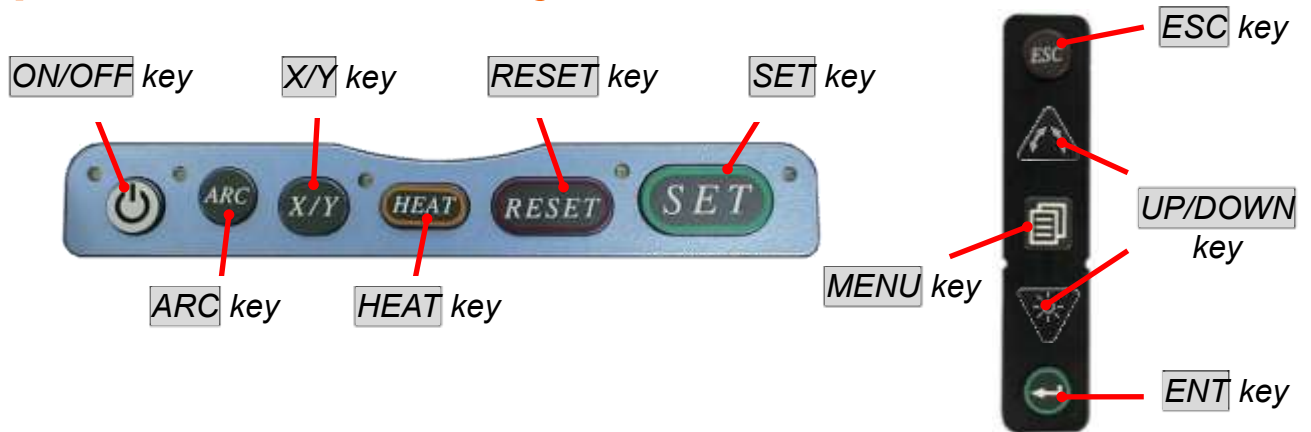

Key Name	Key Function
ON/OFF Power key	To turn ON/OFF the power.
ARC Arc Key	Arc discharge manually.
X/Y X/Y Key	Change the X/Y images
HEAT Heat Key	To start the heating process by the tube heater.
RESET Reset Key	To quit from any state except the heating process by tube heater. After pressing this key, the splicer will return to the ready state with a beep sound.
SET Set Key	To start the splicing operation, or to go through to the PAUSE state. To move the cursor direction of arrow at menu state
ESC Escape Key	To change the X/Y view image and display the data at the "Ready", "Pause", "Finish" state. To quit from input data at the Menu state.
Up/Down Arrow Keys	To adjust the brightness of the monitor screen at the ready state. (Down key) Automatically wind-protector. (Up key) These arrows are used to move the cursor for selecting the items at the menu state, or to change the value or letter of the discharge conditions and comments. During manual motor control, these arrows serve as the "Backward" and "Forward" keys to operate the motors.
MENU Menu Key	Open Main menu and go to next page.
ENT Enter Key	To open the menu at the "Ready" state. To select the command and decide the parameter at the menu state.

Splicing work preparation

The space for working is secured. The work environment according to various uses can be made from using the carrying case of this equipment, and a work tray.

Use a work tray

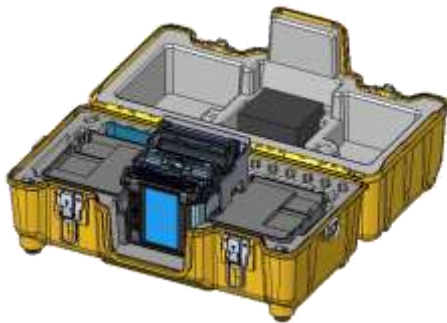

Where a carrying case lid is opened, work can be started immediately.

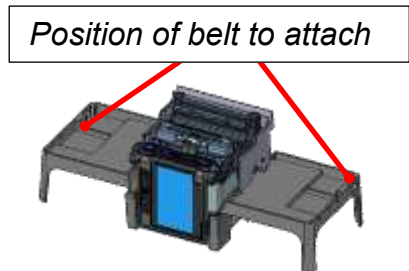

Position of belt to attach

If a work tray is taken out and a belt was used, it can work as a simple working table.



The carrying case itself can be used as a working table. Moreover, original work environment can be made from dividing a work tray.

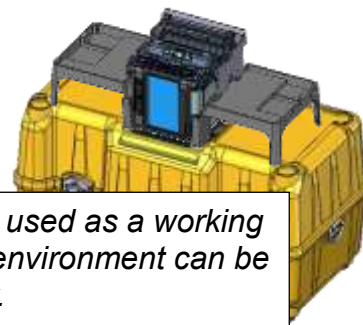

- Arrange safety belts/devices for equipment and accessories on the tray before use. In case the equipment/accessories were dropped to a person under operation area, this would result in serious injury or fatal accident.

In the case of use only with splicer

Use in a location which does not have vibration, a shock, etc. at the time of performing fusion splice work. In work [at the unstable place where a main part is shaky], the possibility of damage from a fall becomes high.

Sleeve Loader

Sleeve loader for holding the Protection sleeve during Splicing.

It is possible that there are dust, rain water, etc. depending on work environment, and garbage, moisture, etc. mix to the protection sleeve under splice.

Putting a protection sleeve on the ground etc. directly by using a sleeve loader is lost, and mixing of garbage or moisture can be prevented.

Moreover, since the protection sleeve was held near the connection position, workability also became good.

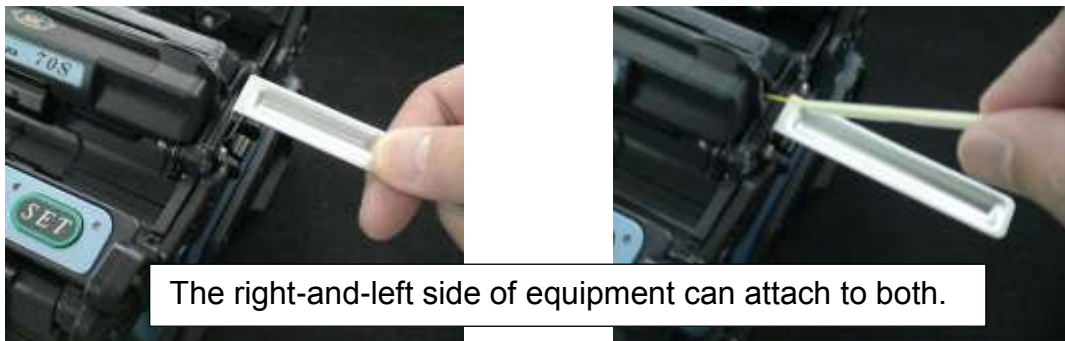

Power Supply

The power supply of a splicer can be operated with AC power supply and a battery.

Inserting or detaching power unit

Inserting power supply unit

Insert power unit into Power unit dock until it clicks into place.



Detaching power supply unit.

Turn off the splicer before removing the power unit. Press the release button, located on the side of the splicer body, and remove the unit from the other side of the release button.



AC Operation

*This section describes the procedures for using the power supply with the equipment. Splicer is operated with AC adapter (ADC-18) or the internal battery. Use the only external AC adapter (ADC-18) and AC Coad (ACC-**) with Splicer.*



AC Adapter [ADC-18]



AC Coad [ACC-**]

Insert AC cord into the AC inlet of the AC adapter. The power ON LED of the AC adapter changes green color when suitable AC voltage is supplied. If high AC Voltage is supplied, the AC adapter will immediately be damaged.



AC generators commonly produce abnormally high AC output voltage.

Measure the output AC voltage with a circuit tester before connecting the AC power cord. Such abnormally high voltage or frequency from a generator may cause fuming, electric shock or equipment damage and may result in personal injury, death or fire.



DC operation with external battery

Open shutter for DC inlet of AC adapter.

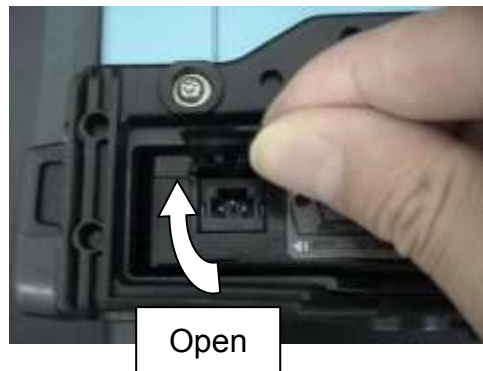

- Do not supply DC16V or greater, the AC adapter will be damaged immediately.

Plug DC cord (DCC-12 or DCC-13) into DC inlet of AC adapter. The ON LED turns on (green color) when suitable DC voltage is supplied. In case DC16V or greater is supplied, or polarity (positive / negative) is wrong, The AC adapter protection circuit shuts down the DC output and DC Warning LED [HIGH ~ INPUT] turns on (red color)

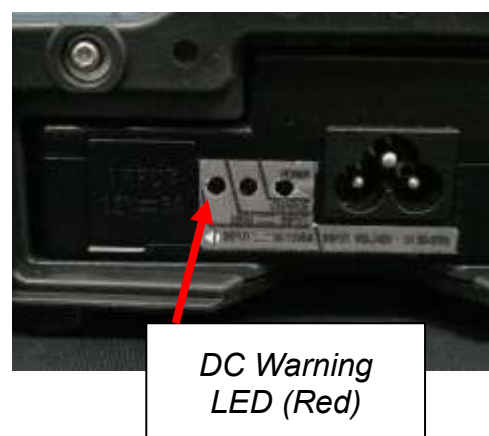
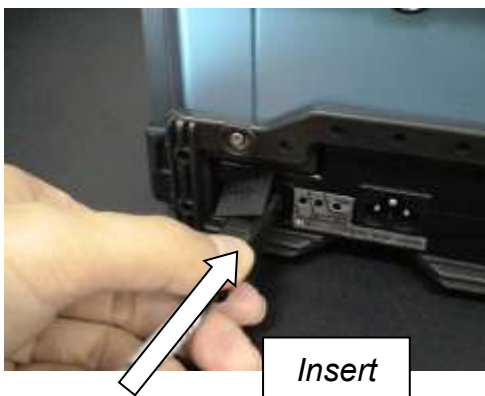

Battery Operation

Check the remaining battery capacity. If it is 20% or less before operation, splicer can only work a few times.



- Keep below practices to prevent battery damage.
Fully charge the battery after every use.
Follow below conditions
- Operation : -10 degree C ~ 50 degree C
- Charging : 0 degree C ~ 40 degree C
- Storage : -20 degree C ~ 30 degree C

How to check remaining battery capacity

If splicer is already equipped with the battery, turn splicer ON. Power source of "Battery" is automatically identified and the remaining battery capacity is displayed on the "READY" screen.







READY screen

Remaining battery capacity display	Remaining battery
	95~100%
	65~95%
	40~65%
	15~40%
<i>Flashing</i>	Less than 15%

If battery is not inserting in the splicer, simply press the battery check push button on the battery pack. The remaining battery capacity is indicated on the LED indicator.



Remaining battery capacity indicator	Remaining battery
	4 LED 95~100%
	3 LED 65~95%
	2 LED 40~65%
	1 LED 15~40%
	1 LED Flashing Less than 15%

The battery residual quantity indicator on a screen is only as a guide. Just after turning splicer ON, if battery capacity is not enough to do operation, a warning message appears in the LCD monitor. Then execute “Battery Discharge” in maintenance menu. After discharge, recharge battery.



- In order to increase the number of fiber splices and times of heating, please change to a power-saving mode setup.

How to charge the battery

Open shutter for battery charge plug inlet of the Battery Pack. Plug the supplied battery charge cord (DCC-18) into both the battery charge inlet of the AC adapter (ADC-18) and the battery charge terminal located on the battery (BTR-09) side.

The CHARGE LED turns ON (orange color) and battery charging begins. Battery charge is completed in approximately five hours. After completion, disconnect DC or AC cord, and then charge cord.

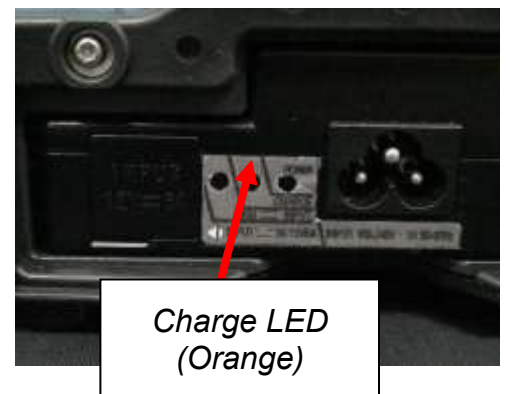
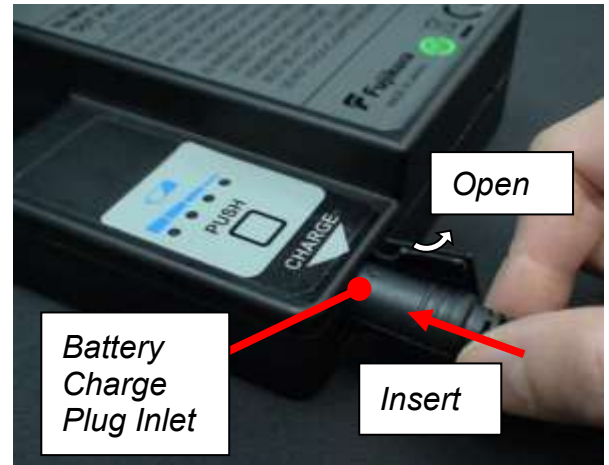

- The battery pack can be charged also with AC and DC.



- Do not place battery on top of AC adapter or vice-versa.
- The battery can be charge while splicer is in use. Installed BTR-09 into power dock and connect to ADC-18 AC adapter/ battery charger. Exchange for a new battery pack.
- CHARGE LED turns off when battery charge is completed. If CHARGE LED flashes, replace the battery with a new one.
- If battery charge does not complete in five hours or CHARGE LED does not turn ON the battery, AC adaptor or both need replacement. Ask your service agent for further instruction.

Turning Splicer ON/OFF

Turning Splicer ON

Press **ON/OFF** key and hold it until the green LED turns on. The following warning screen is displayed.



- The license message is displayed twice a month when the splicer is turn on.
- There is a possibility that a language is fixed depending on the country of shipment.

The READY screen is displayed after all the motors are reset to their initial positions when you select [Agree]. The power source type is then identified. If the battery is used, the remaining battery capacity is displayed.

Turning Splicer OFF

Press **ON/OFF** key and hold until the red LED turns off and then detach.



Up/Down Key function

The following operation is carried out by pressing the **Up/Down** key on a **READY** screen.

LCD brilliance control function

Monitor visibility changes depending on environmental conditions. To change monitor brightness, press **Up/Down** Arrow key to change value and press **ENT** key to set value.

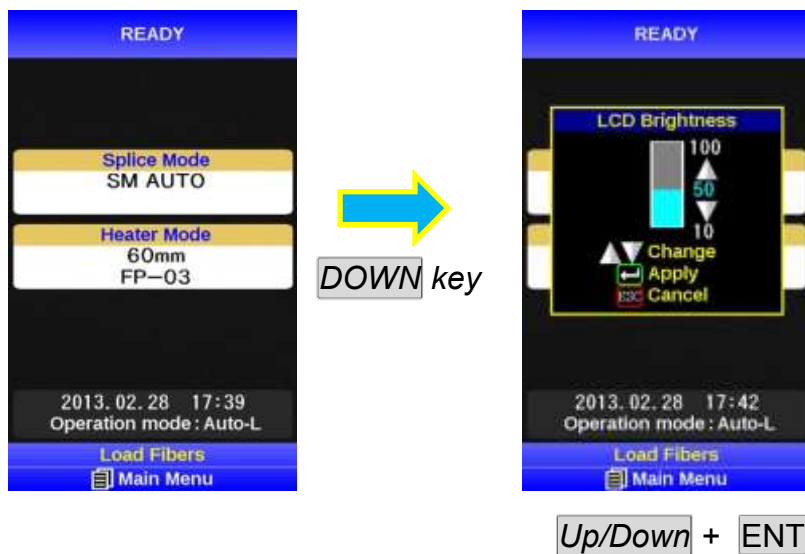

Wind-Protector Automatic opening-and-closing function

If the **Up** key is pressed, a wind-protector will open or close.

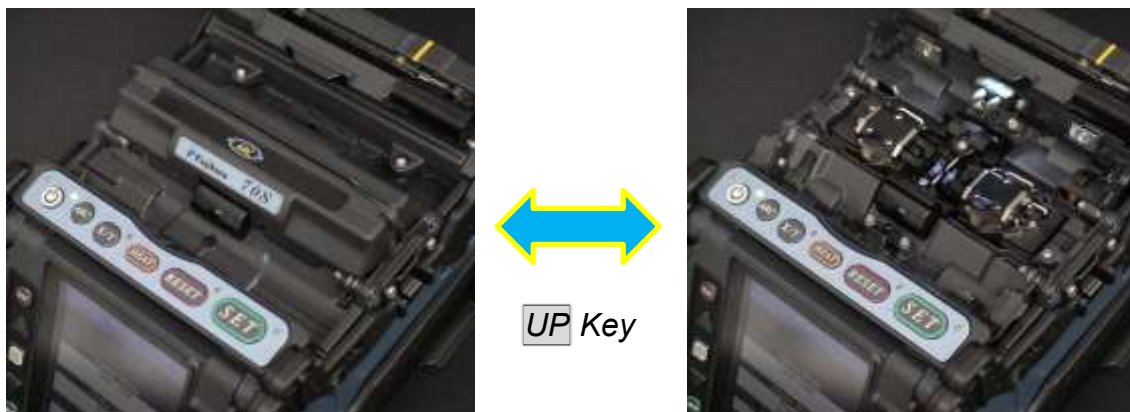

Splicer Settings Check

Composition of a READY screen

Splice Mode

Select appropriate splicing mode for the specific fiber combination. Current mode is displayed on the READY screen.

Heater Mode

Select appropriate heating mode for the specific protection sleeve used. Current mode is displayed on the READY screen.

Calendar

Calendar displayed the date and time on the screen.

Operation Mode

Select appropriate Operation mode for the specific wind-protector operation. Current mode is displayed on the READY screen.



Change of the Operation Mode

Selection of the operation mode

Each operation mode consists of parameters shown below so that operation of the equipment after the end of work can be set up.

The extraction work of a fiber can be smoothly done by working by changing the operation mode according to the contents of work.

Parameter	Description
Operation Mode	
Auto-L	Proof test, wind-protector opening, and sheath clamp opening are automatically performed after the end of splicing. There is the mode of the left, the right, and right and left according to the patulous state of a sheath clamp.
Auto-R	
Auto-LR	
Fast	Wind-Protector opening and a proof test are simultaneously done after the end of connection. Perform sheath clamp opening manually.
Normal	If the SET key is pressed after the end of splice, wind-protector opening and a proof test will be carried out. Perform sheath clamp opening manually.
Manual	All the parameters in custom-made mode are in the state of OFF.
Customized	Sheath Clamp Auto Release
	Setup of the "left", the "right", "right and left", and "OFF" can be performed.
	Auto Start Trigger
	Select of the "OFF", the "Fiber Set", "Cover Close", and "OFF" can be performed.
	Proof Auto Start
	Setup of the "ON" and "OFF" can be performed.
Cover Close Reaction Time	
	Time after a fiber is set until wind-protector closes can be set up.

MENU key is pressed on the [READY] screen; a [Splice Menu] screen will be displayed. The **Down** key is pressed, [Splice Settings] is chosen and the **ENT** key is pressed.

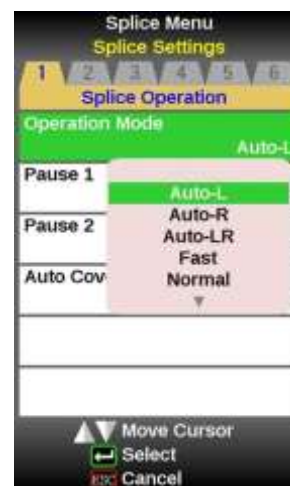
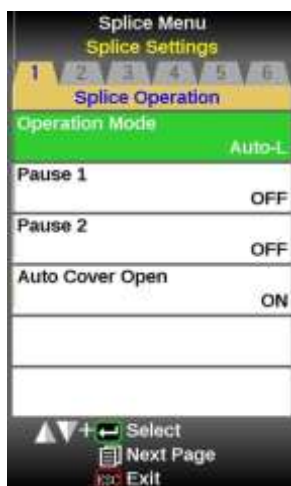

Change of the Splice Mode

The optimal splice setting for a specific fiber combination consists of the splicing parameters listed below. In other words, the optimal splicing parameters depend on the fiber combinations, and are different depending on the fiber used.

- Parameters for controlling arc discharge.
- Parameters for calculating estimated splice loss.
- Parameters for controlling fiber alignment and splicing procedures.
- Threshold for error messages.

A series of optimal splice parameters for major fiber combinations are already stored in the splicer. These parameters are stored in the database area and can be copied to the user-programmable area. These splice parameters can be edited for a specific fiber combination.

How to select the Splice Mode



- **[AUTO SM/NZ/DS/MM]**
Use this mode if the fiber type is not identified.
- **[SM AUTO] and others**
Use this mode if the fiber type is identified.
- **[SM FAST] and others fast**
Use this mode if the fiber type is identified and prefer quick splice with high yield to consistent splice loss.
- **[SM-SM] and others**
Use this mode for splicing special fibers. This mode enables to set specific parameters for each splicing. Execute [Arc Calibration] before using this mode.

Splice Mode selection

Select an appropriate splice mode for type of fiber to be spliced.

1. Press **MENU** key at [READY], [PAUSE] or [FINISH] state to open [Splice Menu]. Select [Select Splice Mode] and the [Select Splice Mode] menu is displayed.
2. Move cursor by pressing **Up/Down** Arrow key and press **ENT** key to select [Splice mode].

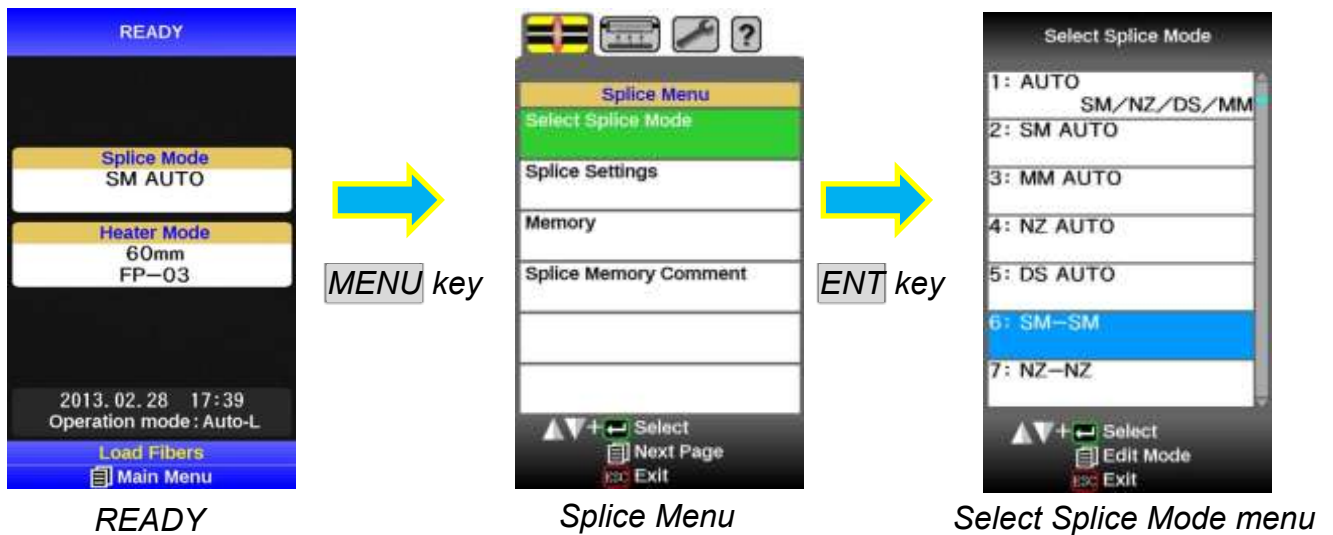

3. Splice Mode can be checked on a READY screen.



Change of the Heater Mode

Each tube-heating mode is optimized for a type of Fujikura protection sleeve. These modes can be found in database area for reference. Copy the appropriate one and paste it to the user-programmable area. The operator can edit the user-programmable modes.

Data Base

Parameter	Description
60mmS FP-03	For standard 60mm protection sleeve, Such as Fujikura FP-03 or FP-03M protection sleeves.
40mmS FP-03(L=40)	For standard 60mm protection sleeve, Such as Fujikura FP-03 or FP-03M protection sleeves. Note : Cleave length 8mm.
40mmR FP-04T	For standard 40mm protection sleeves, Such as Fujikura FP-03 (L=40).
15mmS FPS01-400-15	400 or less μm of diameters of coating. Splice of the interference length of 5 mm or less
20mmS FPS01-900-20	900 or less μm of diameters of coating. Splice of the interference length of 6 mm or less
60mmS FPS01-DC-60	For Splice of a drops cable.
28mmS FC-SC-**-30/20	For Fuse connect splice.
45mmS FC-SC-**-09	

The dimensions of the Protection Sleeve after heat shrink

Form	Tension member	Sleeve length	Prepare fiber length	Diameter of an adaptation optical fiber	Diameter of a result
FP-03	SUS	60mm	16mm or less	250~900 μm	3.1mm
FP-03(40mm)	SUS	40mm	10mm or less	250~900 μm	3.1mm
FP-04T	Glass ceramic	40mm	10mm or less	250~900 μm	4.0mm
FPS01-400-15	SUS	15mm	5mm or less	~400 μm	1.5mm
FPS01-900-20	SUS	20mm	6mm or less	~900 μm	2.3mm

* The dimensions of the protection sleeve after shrink are varied depending on the diameter of the fiber.

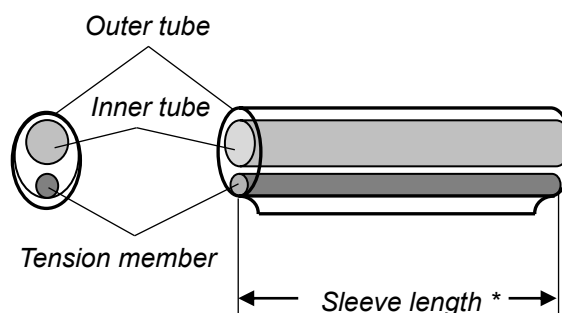

Selecting Heater mode

Select the heater mode most suitable for the protection sleeve to be used.

1. Press **MENU** key in [READY], [PAUSE], [FINISH] state and press **MENU** key to display [Heater Menu].
2. Select [Select Heater Mode] in [Heater Menu]. [Select Heater Mode] menu is displayed.
3. Move cursor by pressing **Up/Down** Arrow key and press **ENT** key to select a heater mode.

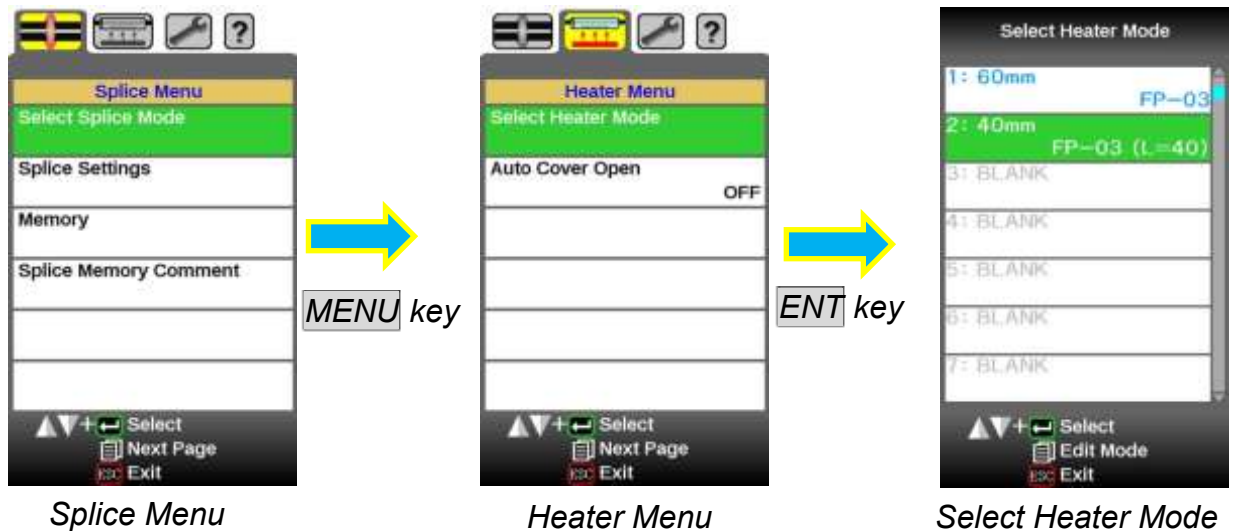

4. The check in the heater mode selected on the OK screen can be performed.



- When using a protection sleeve which is not made by Fujikura, please set parameters based on the specific sleeve.
- When the sleeve of another company is used, the durability of a protection point cannot be warranted.

Preparation of fiber

Cleaning optical fiber

Clean optical fiber with alcohol-moistened gauze or lint-free tissue approximately 500mm from the tip. Dust particulates from the fiber coating surface can enter inside the protection sleeve and might result in a future fiber break or attenuation increase.

Placing protection sleeve over fiber

Place the protection sleeve over the Right side fiber.



- Since a left hand serves as a standard at the time of fiber conveyance, the method of inserting a sleeve in a right-hand side fiber is recommended.

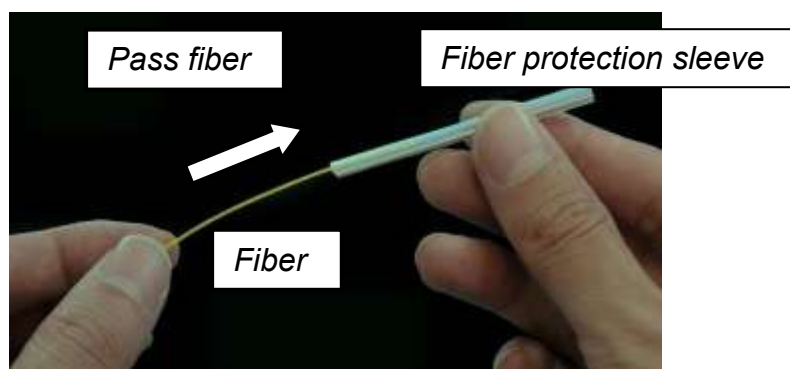

Fiber coating stripping and cleaning of bare fiber

Strip the outer coating 30 to 40 mm from fiber tip with a stripping tool. Clean the fiber with alcohol moistened gauze or lint-free tissue thoroughly. Frequently replace cleaning gauze to insure splice quality.

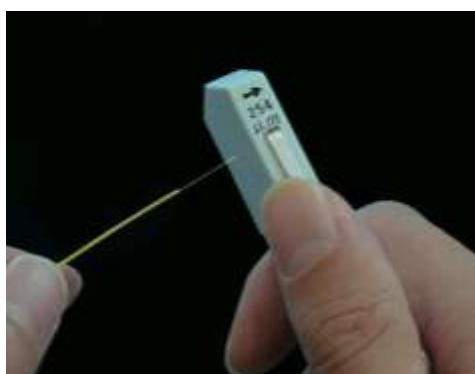

Stripping

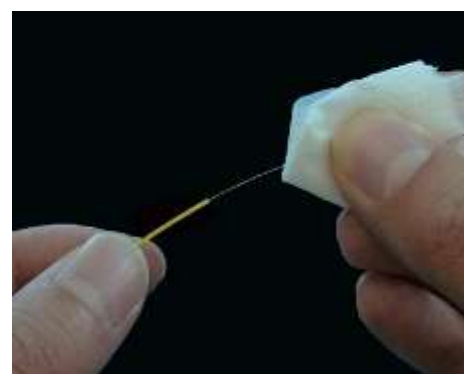
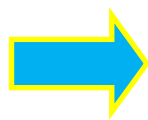

Cleaning



- Use a high quality alcohol, greater than 99% pure.

Fiber Cleaving in the case of using a sheath clamp

To unlock the cutting lever, press it gently and slide the stopper.
Push the slide button until it locks and set the stripped optical fiber on the cleaver.



Press down the cutting lever. Release the pressure on the cutting lever. A spring force will bring it to its open position.



- Confirm the sheath of fiber is not on pad when fiber holder is used.

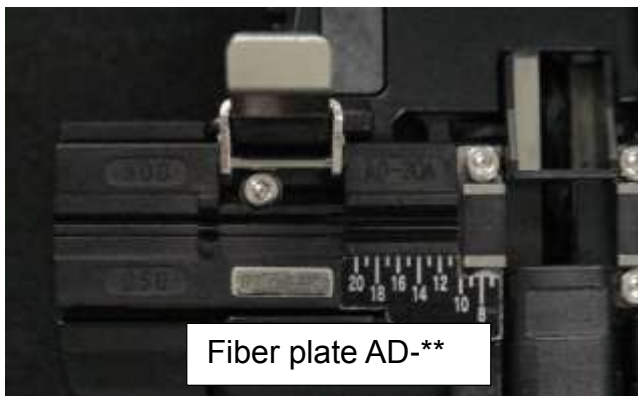

Fiber Cleaving in the case of using a Fiber holder

Set the fiber onto fiber holder

Set the fiber onto the fiber holder with the fiber sheath 3mm from the end of the fiber holder and then close the fiber holder lid.



- Close the lid of a fiber holder while pressing down with a finger on the coating (refer to figure below).
- Select a suitable fiber holder based on the fiber coating diameter.
- If fiber coating has some memory curl, place fiber so that the curve of memory is turned downwards.

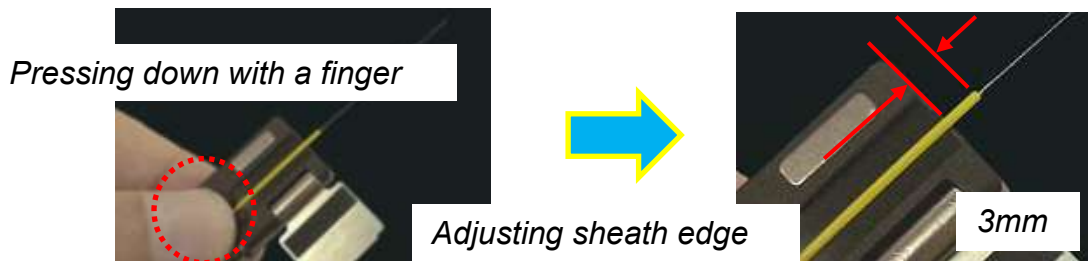

To unlock the cutting lever, press it gently and slide the stopper. Push the slide button until it locks and set the stripped optical fiber on the cleaver.



Press down the cutting lever. Release the pressure on the cutting lever. A spring force will bring it to its open position.



- Confirm the sheath of fiber is not on pad when fiber holder is used.



Not Good

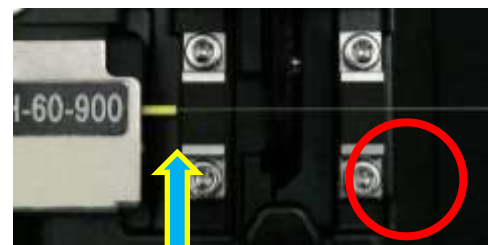

Good



- Do not put fingers in the driving area of the slide button as personal injury may result.
- After pressing it only half way down, releasing the pressure on the cutting lever may result in bad cleaving quality.

Loading fiber to splicer

Using sheath clamp

1. Open the wind-protector and sheath clamps.
2. Place prepared fiber onto v-groove so that the fiber tip is located between the v-groove edge and tip of electrode.

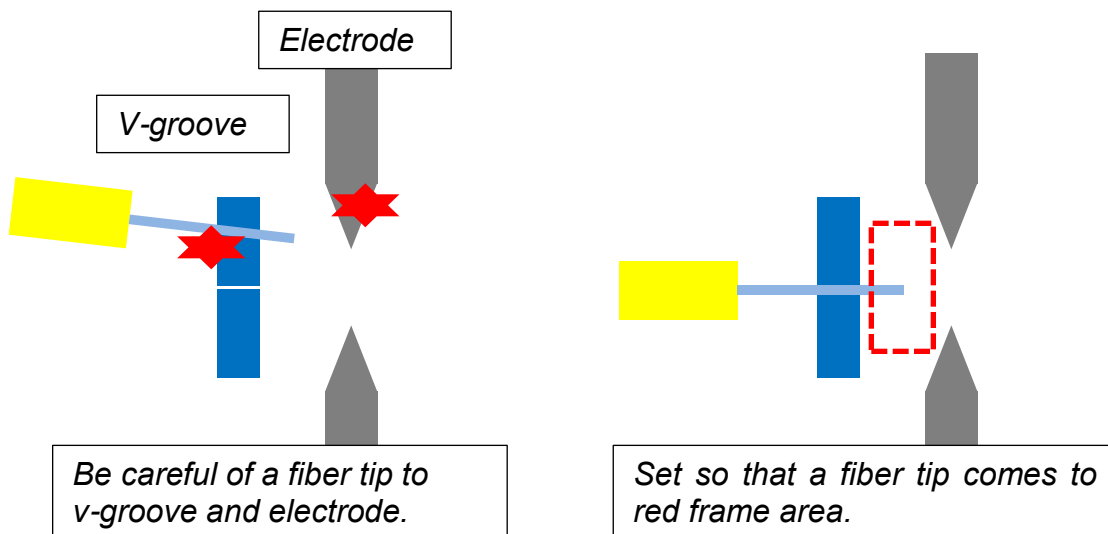
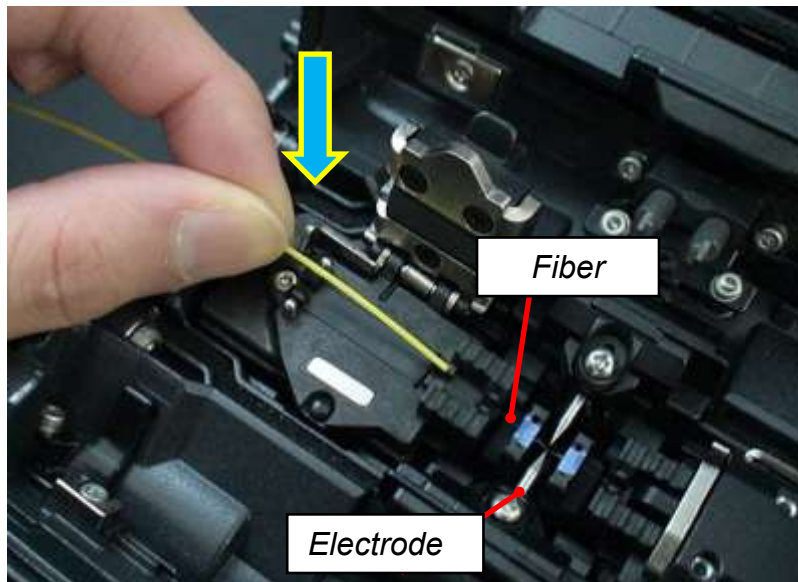

- Be careful not to contact the prepared fiber tips into anything to maintain fiber end-face quality.

3. Hold fiber with fingers and close sheath clamp so that the fiber does not move. Make sure the fiber is placed in the bottom of the v-grooves. If fiber is not placed properly, reload fiber.

The prolonged storage back and when splicing for the first time, we recommend you execute for an Arc Calibration.
Refer to [Arc Calibration].

Using Fiber Holder

1. Loosen a screw beside sheathe clamps and take the sheathe clamps off the splicer.



2. Place fiber holders so that the guide pins on the stage go to guide-holes in the fiber.

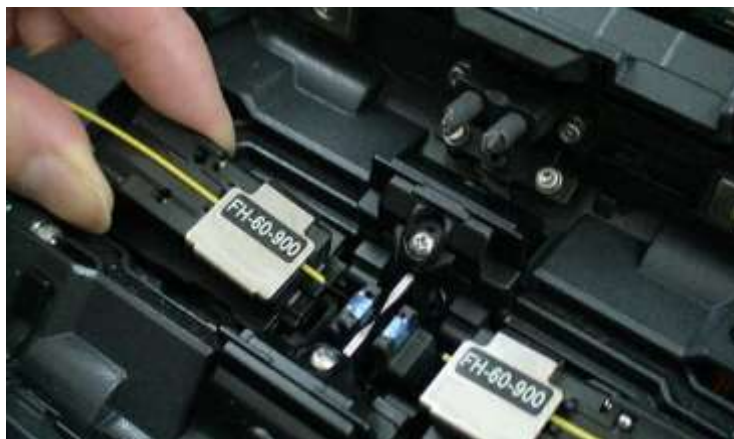

- Be careful not to contact the prepared fiber tips into anything to maintain fiber end-face quality.

3. Wind-protector is closed automatically. The splicer starts the splice procedure automatically.

*The prolonged storage back and when splicing for the first time, we recommend you execute for an Arc Calibration.
Refer to [Arc Calibration].*

Arc Calibration

Atmospheric conditions such as temperature, humidity, and pressure are constantly changing, which creates variability in the arc temperature. This splicer is equipped with temperature sensor that is used in a constant feedback monitoring control system to regulate the arc power at a constant level. Changes in arc power due to electrode wear and glass adhesion cannot be corrected automatically. Also, the center position of arc discharge sometimes shifts to the left or right. In this case, the fiber splicing position has to be shifted in relation to the arc discharge center. It is necessary to perform an arc power calibration to eliminate both of these issues.



- Arc calibration is performed automatically using [AUTO] mode only. So arc calibration does not have to be performed when splicing in this mode.
- Execute [Arc calibration] before using non-auto mode.
- When Performing the [Arc Calibration] function change the arc power "factor" value. The factor value is used in the algorithm program for all splicing. The arc power value will not change in the splice modes.

Operation procedure

1. Select [Arc Calibration] in [Maintenance Menu] to display Arc Calibration screen.
2. Set prepared fibers onto the splicer.

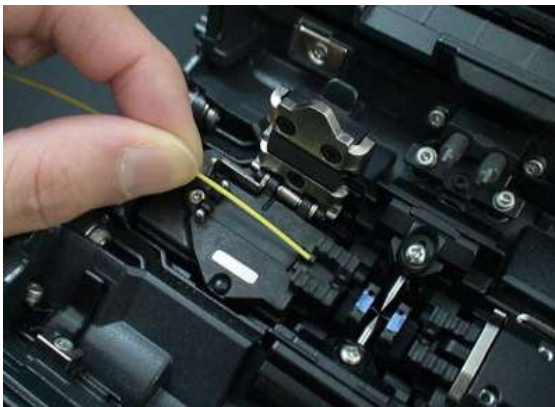

- Use standard SMF ITU-T G652 fiber for Arc Calibration.
- Use well prepared fibers for arc calibration. Dust on the fiber surface affects arc calibration.
- Cleave angle threshold does not link to the parameter "Cleave Limit" in splicing modes. Cleave angle threshold is independently set for arc calibration. See section [Machine Settings] to change cleave angle threshold.

3. The ARC Calibration after pressing **ENT** key.

“Good” message

Arc power and splicing position calibration are successfully completed. Press **ESC** key to exit.

Result: Good

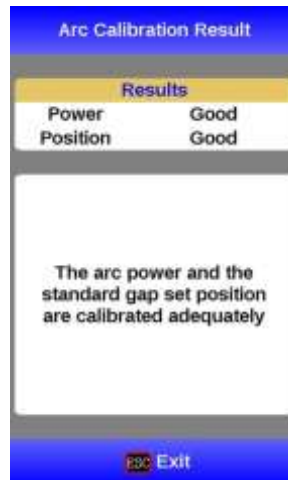

“Not Adequate” message

Arc power and splicing position calibration are completed but further calibration is strongly recommended, as the change from the previous arc calibration is too large. Press **ENT** key to perform arc calibration, or **ESC** key to exit even though arc calibration is not completed.

Result: Not Adequate

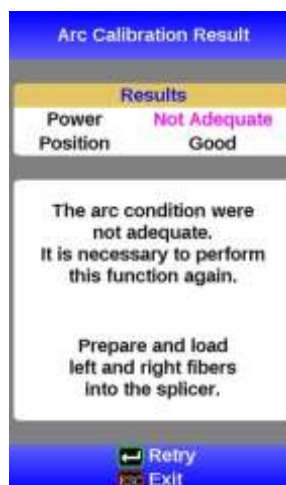

- In some cases, multiple iterations of arc calibration are needed until the calibration process is successfully completed and the "Test Finish" message is displayed. Arc calibration can be considered almost completed if multiple iterations are completed without receiving the message.
- Number threshold can be set so that "Test Finish" message is displayed after specific number of arc calibrations is performed. See section [Machine Settings] for detail.



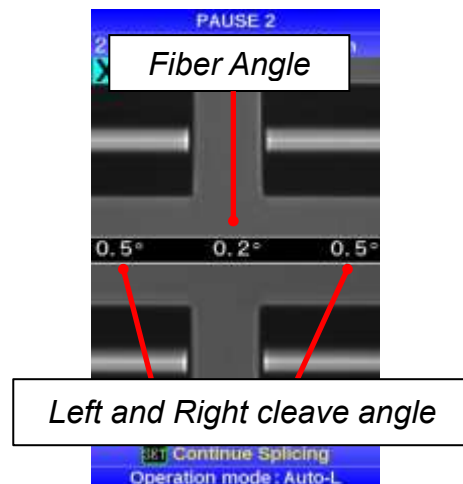

Splicing procedure

To make a good splice, the optical fiber is observed with the image processing system equipped in the 70S. However, there are some cases when the image processing system cannot detect a faulty splice. Visual inspection with the monitor is often necessary for better splicing yield. The instruction below describes standard operating procedure.

1. Fibers loaded in the splicer move forward toward each other. The fiber forwarding motion stops at a certain position shortly after the cleaning arc is performed.
2. Next, the cleave angle and end-face quality are checked. If the measured cleave angle is greater than its set threshold or fiber chipping is detected, the buzzer will sound and an error message warns the operator.



3. If no error message is displayed, the below stated end-face conditions are used for visual inspection. If observed, remove the fiber from the splicer and repeat fiber preparation. These visual defects may cause a faulty splice.

Cleave Shape NG		Large Cleave Angle	
			
Chip	Lip		Angle



- Pause after cleave angle check and fiber alignment can be set “disabled”. See section [Splice Settings] for detail.
- The cleave angle threshold can be changed. See section [Splice Menu]
- The cleave angle error message can be ignored by pressing **SET** key to go on to the next step. To disable the cleave angle error. See section [Splice Settings] for detail.
- Cleave angle, during the splicing operation can be hidden. See section [Splice Settings] for detail.

4. Cladding axis offset measurements can be displayed and after completion of arc discharge is performed to splice the fibers.
5. Estimated splice loss is displayed upon completion of splicing. Splice loss is affected by certain factors stated. These factors are taken into account to calculate, or estimate, splice loss. The calculation is based on certain dimensional parameters, such as MFD.

If either the cleave angle measured or the estimated splice loss exceeds its set threshold, an error message is displayed. If the spliced fiber is detected as abnormal, the "Fat", "Thin" or "Bubble" error message is displayed.

If no error message is displayed but the splice looks poor by visual inspection through the monitor, it is strongly recommended to repeat the splice from the beginning.



Splice loss may be improved in some cases by additional arc discharges. Press **SET** key for an additional arc discharge (re-arc). Splice loss estimate and splice check are performed again.











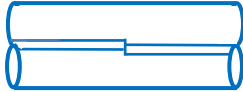

- Restriction of the number of times of additional arc discharge can be set up. Since excessive additional arc discharge becomes the cause of worsening splice intensity and a splice loss, it can forbid the arc discharge more than the suitable number of times. Refer to [Splice Settings] for details.

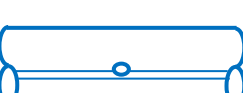

- Splice point sometimes looks a bit fatter than other parts. This is considered a normal splice, and does not affect splice loss.
- To change threshold for estimated splice loss or fiber angle, see section [Splice Mode].
- Error messages, such as "Estimated splice loss", "Splice angle", "Fat", "Thin" and "Bubble" can be ignored. This function can be set to "disabled". See section [Splice Settings] for detail.

Splice loss increase: Cause and remedy

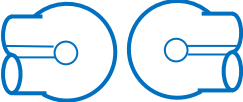
Symptom	Cause	Remedy
Axial offset 	Dust on v-groove or fiber clamp chip	Clean v-groove and fiber clamp chip.
Fiber angle 	Dust on v-groove or fiber clamp chip	Clean v-groove and fiber clamp chip.
	Bad fiber end-face quality	Check if fiber cleaver is well conditioned.
Core Step 	Dust on v-groove or fiber clamp chip	Clean v-groove and fiber clamp chip.
Core Curve 	Bad fiber end-face quality.	Check if fiber cleaver is well conditioned.
	Prefuse power too low or prefuse time too short.	Increase [Prefuse Power] and/or [Prefuse Time].
MFD Mismatch 	Arc power too low	Increase [Arc Power] and/or [Arc Time].
Combustion 	Bad fiber end-face quality	Check the cleaver
	Dust still present after cleaning fiber or cleaning arc.	Clean fiber thoroughly or Increase [Cleaning Arc Time]
Bubbles 	Bad fiber end-face quality	Check if fiber cleaver is well conditioned.
	Prefuse power too low or prefuse time too short.	Increase [Prefuse Power] and/or [Prefuse Time].

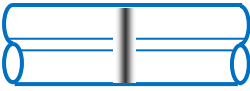
Symptom	Cause	Remedy
Separation 	<i>Fiber stuffing too small</i>	<i>Perform [Motor Calibration]</i>
	<i>Prefuse power too high or prefuse time too long.</i>	<i>Decrease [Prefuse Power] and/or [Prefuse Time].</i>
Fat 	<i>Fiber stuffing too much</i>	<i>Decrease [Overlap] and perform [Motor Calibration].</i>
Thin 	<i>Arc power not adequate</i>	<i>Perform [Arc Calibration].</i>
	<i>Some arc parameters not adequate</i>	<i>Adjust [Prefuse Power], [Prefuse Time] or [Overlap].</i>
Line 	<i>Some arc parameters not adequate</i>	<i>Adjust [Prefuse Power], [Prefuse Time] or [Overlap].</i>



- *A vertical line sometimes appears at the splice point when MM fibers or dissimilar fibers (different diameters) are spliced. This does not affect splice quality, such as splice loss or tensile strength.*

Storing splicing results

Splicing results is stored in memory.



- After the 2000th result is stored, 2001st splice result is written over 1st result.

Storing results automatically

The splice result is automatically stored in memory when **RESET** is pressed upon completion of the splice at the [Finish] screen or when the wind-protector is opened upon completion of the splice at the [Finish] screen.

Once a certain comment is recorded, the same comment is recorded into subsequent splice results. To change comments, see the next paragraph.

How to input Mode Title/Comment/Password

Character list below is displayed by selecting Mode Title / Comments / Password.

1. Move the cursor by pressing **Up/Down** Arrow key, **MENU** key, and press **ENT** key to input the selected character. If an incorrect character is inputted, move the cursor to [BS] and press **ENT** key to highlight the character, and then input the proper character over it.
2. Move cursor to [ENTER] on right side and press **ENT** key on completion of inputting characters.
3. In the case of Password input, the next screen image is displayed if the correct password is inputted. If the input password is incorrect, the previous screen image is displayed.

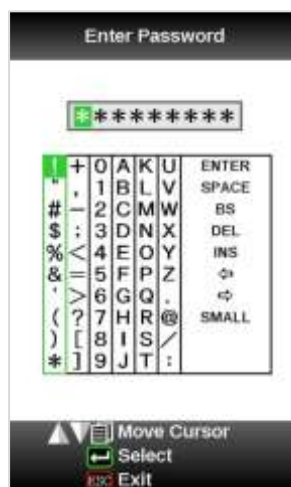

CAPS Characters

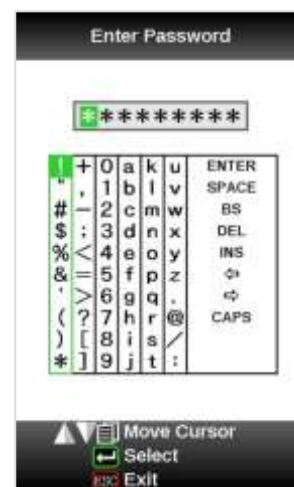

SMALL Characters

Fiber Proof Test

The strength of the splice point can be checked. When finished press **RESET** or open wind-protector and fiber proof test will be performed.



A motion changes by the selected operation mode.

Heating protection sleeve

1. Hold left fiber with left hand at the edge of splicer.



- Keep holding fiber until fiber is completely transferred to tube heater.

2. Open the right side sheath clamp lid.
3. Place the protection sleeve over the Right side fiber to splice point.
4. Hold right fiber with right hand, and remove the splicer.
5. If a protection sleeve is put on the centering guide on the heater upper surface and a left position is moved in the case of the equipment left, a connection point will be moved focusing on a protection sleeve.

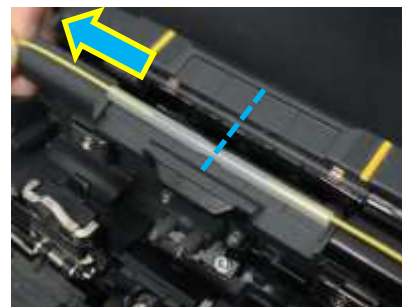

A protection sleeve is moved to a splice point, holding a fiber with the left hand. It prevents slack from occurring at a splice point. Moreover, there is a possibility of fracturing if an excessive tension starts.



- Check that the splice point is located in the center of a protection sleeve.
- Check whether the twist has occurred on the right-and-left fiber.
- A tension member is designed to rest below a splice point.

6. Optical fiber is conveyed to a heater unit, and it takes down to a heater part and holds.



- Make sure the splice point is located at the center of the protection sleeve.
- Make sure the strength member in the protection sleeve is placed on bottom.



When a protection sleeve set position exceeds a yellow line, un-contracting of a protection sleeve occurs.

In this case, please set to a heater once again and perform re-heating.

7. Heater lid automatically closes when fiber is set. Do not remove hands from fiber until heating starts followed by beeps.

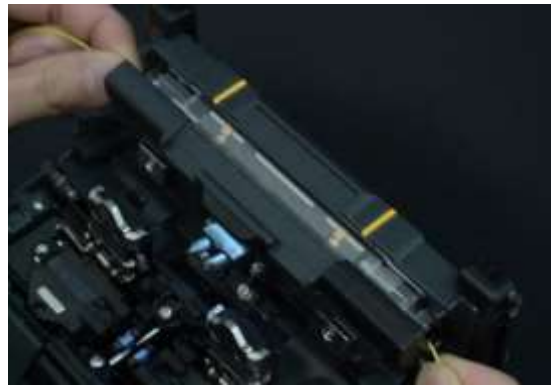

- If **HEAT** key is pressed during tube heating, the HEAT LED blinks. If **HEAT** key is pressed again, the tube heating process is aborted.

8. If heat processing is completed, buzzer sound will sound and a heater lid will open automatically.



- Protection sleeve may stick to bottom plate of heater. Use a cotton swab to help remove sleeve from heater.
- Since it gets very hot in the heater and the sleeve will get hot, you should not touch the sleeve immediately after heating.

Visually inspect the finished sleeve to verify no bubbles or debris/dust is present in the sleeve.

Cleaning and Checking before Splicing

It is possible to maintain the performance of the splicer for a long time with proper cleaning and maintenance.

Critical cleaning points and maintenance checks are described below.

Cleaning V-grooves

If contaminants are present in the V-grooves, proper clamping may not occur, resulting in higher splice loss. The V-grooves should be frequently inspected and periodically cleaned during normal operation. To clean the V-grooves do the following:

1. *Open the wind-protector.*
2. *Clean the bottom of the V-groove with an alcohol-moistened thin cotton swab. Remove excess alcohol from the V-groove with a clean dry swab.*

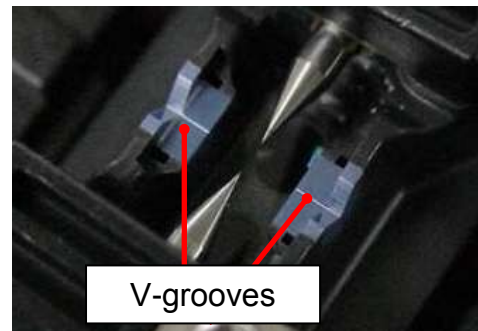

- *Be careful to not contact the electrode tips.*

3. *If the contaminants in the V-groove cannot be removed with an alcohol-moistened thin cotton swab, use a cleaved fiber end-face to dislodge contaminants from the bottom of the V-groove. Repeat step section 2 after this procedure.*

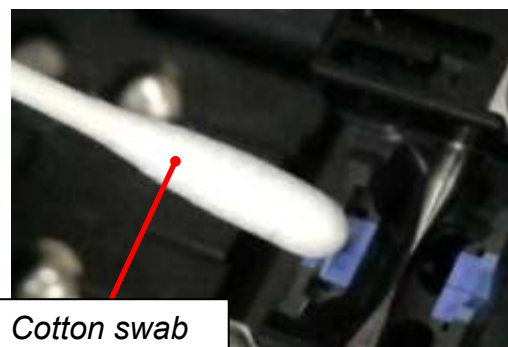
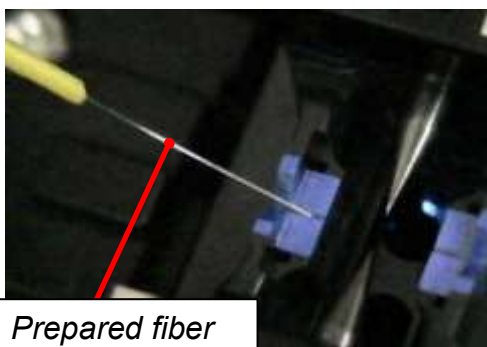

Cleaning Fiber Clamp Chips

If contaminants are present on the clamp chips, proper clamping may not occur, resulting in poor quality splices. The fiber clamp chips should be frequently inspected and periodically cleaned during normal operation. To clean the clamp chips do the following:

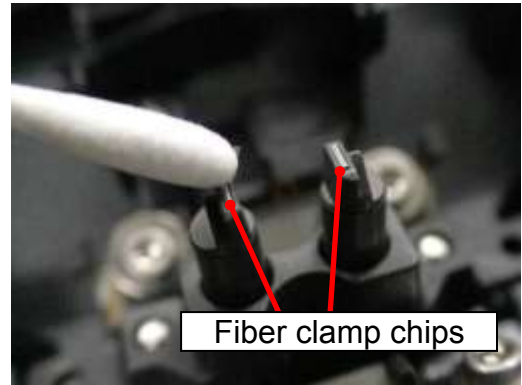

1. Open the wind-protector.
2. Clean the surface of the chip clamp with an alcohol-moistened thin cotton swab. Remove excess alcohol from the chip clamp with a clean dry swab.

Cleaning Fiber Cleaver of CT-30

If the circular blade or clamp pads of the fiber cleaver become contaminated, the cleaving quality could degrade. This may lead to fiber surface or end-face contamination, resulting in higher splice loss. Clean the circular blade or clamp pads with cotton swab moistened with alcohol.

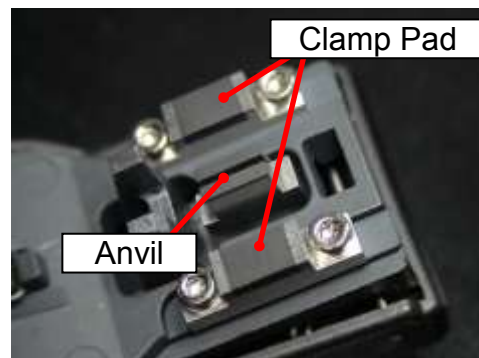
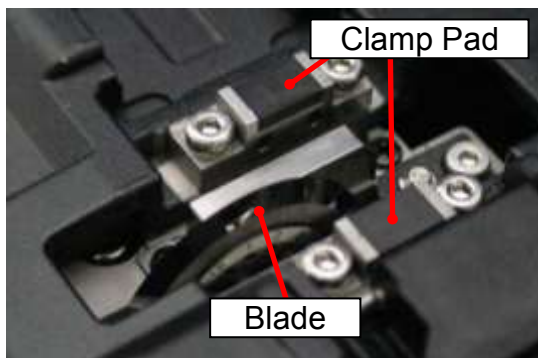

Arc Calibration

See Section [Maintenance Menu].

Periodical Checking and Cleaning

In order to maintain the splicing quality of the splicer, periodical inspection and cleaning are recommended.

Cleaning of Objective Lens

If the surface of the objective lens becomes dirty, inaccurate observation of the fiber position may occur, resulting in higher splice loss or poor splicer operation. Therefore, clean objective lens. Otherwise, dirt may accumulate and become impossible to remove. To clean the objective lens, do the following:

1. Before cleaning the objective lens, always turn off the splicer.
2. Gently clean the lens with an alcohol-impregnated thin cotton swab. Remove excess alcohol from the lens surface with a clean dry swab.



- Remove electrodes before cleaning objective lens.
- Do not hit or touch the tip of the electrode when cleaning.



3. The lens surface should be clean and free of streaks or smudges.
4. Turn on the power and make sure no smudges or streaks are visible on the monitor screen. Perform the Dust Check procedure.

Cautions were displayed

Cleaver Blade Alarm displayed

Position Changing CT-30 Cleaver Blade

If the cleaver does not cleave properly, rotate the blade 1/16th of a turn to replace the worn out blade position with a sharp blade position. Blade life is normally 1000 cleaves per blade position. To rotate the blade, do the following:

1. Push the slide button until it locks. And using a 1.5mm hex wrench, loosen the blade lock screw.

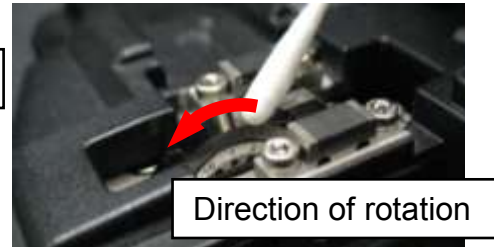
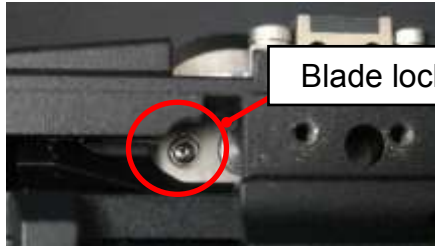

2. Rotate the circular blade 1/16th of a turn. (Use Cotton Swab)
3. Tighten the blade lock screw.



- When rotating the blade, do not touch the cutting edge. Move the blade with a thin cotton swab, for easy and safe rotation.

Blade Height changing

After the circular blade has been rotated a complete revolution (16 positions), its height needs to be adjusted to compensate for the wear.

1. Push the slide button until it locks. And using a 1.5mm hex wrench, loosen the blade lock screw
2. Using a 1.5mm hex wrench, loosen the adjuster lock screw.
3. Using a 1.5mm hex wrench, turn the adjuster clockwise so that the reference dot aligns with the next position mark. Never attempt to rotate the adjuster more than 2 position marks.
4. Tighten the adjuster lock screw.



- After blade height adjustment, the 16 blade positions can be used again. If the cleaver does not cleave properly, rotate the blade.

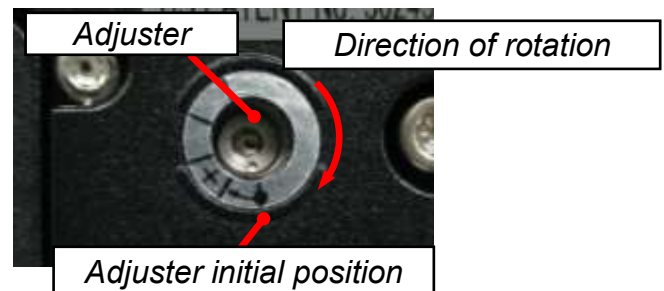
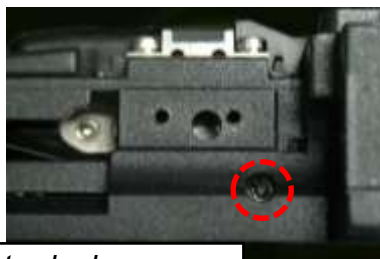

Blade Replacement

After the circular blade has been raised 2 times and rotated through all 3 positions (a total of approximately 48,000 fiber splices), it needs to be replaced. Contact the authorized distributor.

Electrode Caution displayed

Replace Electrodes

See Section [*Replace Electrodes*].

Another error displayed

Diagnostic Test

See Section [*Diagnostic Test*].

Composition of Splice Menu

Common parameters for the modes for splicing and machine setting can be set.

1. Press **MENU** key at [READY], [PAUSE] or [FINISH] state to open [Splice Menu].
2. Move cursor by pressing **Up/Down** Arrow key to a parameter to be selected.
3. Press **ENT** key to change values and settings.

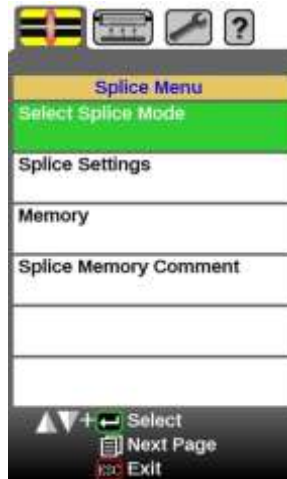

Setting parameters

Parameter	Description
Select Splice Mode	Mode according to the fiber to splice can be chosen.
Splice Settings	Common parameters for all the modes for splicing and operation can be set.
Memory	A situation can be checked after splicing with this machine.
Splice Memory Comment	A comment can be added to the memory saved at the time of the end of connection.

Splice Mode

The optimal splice setting for a specific fiber combination consists of the splicing parameters listed below. In other words, the optimal splicing parameters depend on the fiber combinations, and are different from fiber to fiber.

- Parameters for controlling arc discharge.
- Parameters for calculating estimated splice loss.
- Parameters for controlling fiber alignment and splicing procedures.
- Threshold for error messages.

A series of optimal splice parameters for major fiber combinations are already stored in the splicer. These parameters are stored in the database area and can be copied to the user-programmable area. These splice parameters can be edited for a specific fiber combination.

How to select the "Splice Mode"



- [AUTO SM/NZ/DS/MM]
Use this mode if the fiber type is not identified.
- [SM AUTO] and others
Use this mode if the fiber type is identified.
- [SM FAST] and others
Use this mode if the fiber type is identified and prefer quick splice with high yield to consistent splice loss.
- [SM-SM] and others
Use this mode for splicing special fibers. This mode enables to set specific parameters for each splicing. Execute [Arc Calibration] before using this mode.

Below is a figure showing the Arc discharge conditions (relationship between "Arc power" and "Motor motion"). The conditions can be edited by changing the splicing parameters listed below. Depending on splice mode, certain parameters cannot be changed.

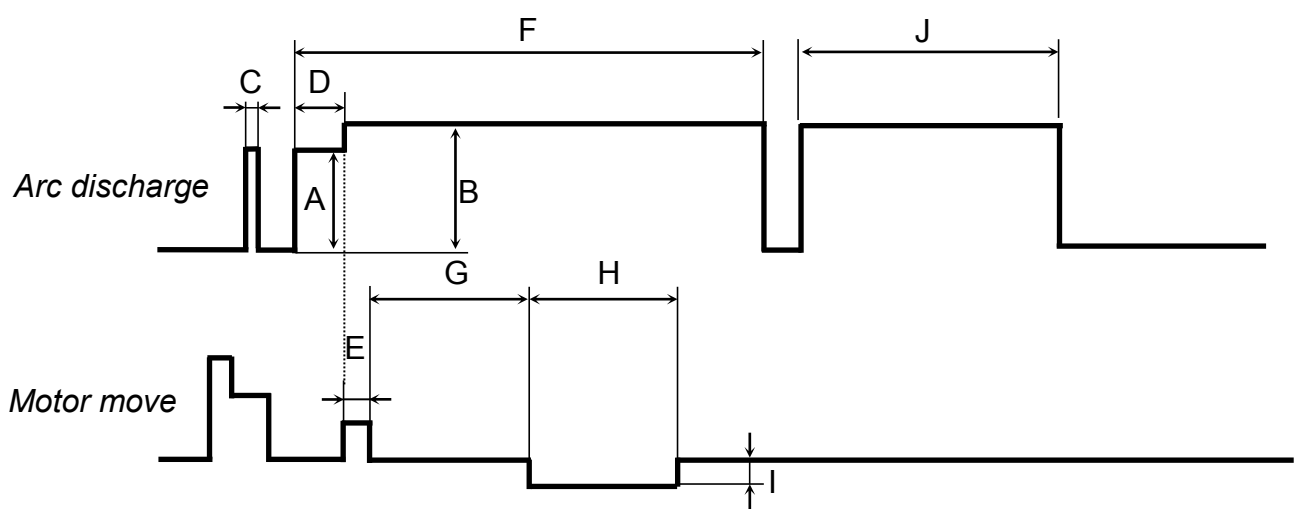

A: Prefuse Power,
D: Prefuse Time,
G: Taper Wait Time,
I: Taper Speed,

B: Arc Power,
E: Overlap,
H: Taper Time related to Taper Length,
J: Rearc Time

C: Cleaning Arc
F: Arc Time

Select Splice Mode

Database of splice mode (AUTO)

Splice Mode	Description
AUTO SM/NZ/DS /MM	<p>This splice mode can splice standard telecommunications grade fiber, including SMF (ITU-T G.652), NZDSF (ITU-T G.655) and DSF (ITU-T G.653).</p> <p>The amount of heat applied to the fiber is calibrated in real time by analyzing the cladding illumination during arc discharge and adjusting the arc current accordingly. This splice mode does not require the operator to perform an arc calibration.</p>
SM AUTO	<p>This splice mode can splice the standard SM fiber (ITU-T G.652). The amount of heat applied to the fiber is calibrated in real time by analyzing the cladding illumination during arc discharge then adjusting The arc current accordingly. This splice mode does not require the operator to perform an arc calibration.</p>
MM AUTO	<p>This splice mode can splice the standard MM fiber (ITU-T G.651).</p> <p>The amount of heat applied to the fiber is calibrated in real time by analyzing the cladding illumination during arc discharge then adjusting The arc current accordingly. This splice mode does not require the operator to perform an arc calibration.</p>
NZ AUTO	<p>This splice mode can splice the standard NZDS fiber (ITU-T G.655).</p> <p>The amount of heat applied to the fiber is calibrated in real time by analyzing the cladding illumination during arc discharge then adjusting the arc current accordingly. This splice mode does not require the operator to perform an arc calibration.</p>
DS AUTO	<p>This splice mode can splice the standard DS fiber (ITU-T G.653).</p> <p>The amount of heat applied to the fiber is calibrated in real time by analyzing the cladding illumination during arc discharge then adjusting the arc current accordingly. This splice mode does not require the operator to perform an arc calibration.</p>

Points to note: of AUTO SM/NZ/DS/MM mode



- NZDS is specified using the splicing mode for standard NZDS fiber. However, for best results, it is recommended that the optimum splice mode be selected for a specific type of NZDS fiber. This is due to the variation in the NZDS fiber properties and optimum splicing parameters are different from one type of NZDS fiber to the next.

Database of splice mode (Same Fiber)

Splice Mode	Description
SM-SM	For splicing standard Single-mode fiber (ITU-T G652). The MFD is 9 to 10 μm at wavelength of 1310 nm. Automatic arc calibration doesn't work in this splice mode.
NZ-NZ	For splicing Non-zero dispersion-shifted fiber (ITU-T G655). The MFD is 9 to 10 μm at wavelength of 1550 nm. Automatic arc calibration doesn't work in this splice mode.
DS-DS	For splicing Dispersion-shifted fiber (ITU-T G653). The MFD is 7 to 9 μm at wavelength near 1550 nm. Automatic arc calibration doesn't work in this splice mode.
MM-MM	For splicing Multi-mode fiber (ITU-T G651). Core diameter : 50.0 to 62.5 μm Automatic arc calibration doesn't work in this splice mode. This mode is programmed to achieve the best splice loss of MM fiber. The appearance of splice point doesn't look fat

Profile type

SMF :	ITU-T G652	MFD : 9~10 μm , Wave length : 1310nm
NZDSF :	ITU-T G655	MFD : 8~10 μm , Wave length : 1550nm
DSF :	ITU-T G653	MFD : 7~9 μm , Wave length : 1550nm
MMF :	ITU-T G651	Core : 50.0 μm , 62.5 μm

Database of splice mode (FAST)

Splice Mode	Description
SM FAST	For splicing standard Single-mode fiber (ITU-T G652). The MFD is 9 to 10 um at wavelength of 1310 nm. Automatic arc calibration doesn't work in this splice mode. Execute [Arc Calibration] before splicing.
MM FAST	For splicing Multi-mode fiber (ITU-T G651). Core diameter : 50.0 to 62.5 um Automatic arc calibration does not work in this mode. Execute [Arc Calibration] before splicing.
NZ FAST	For splicing Non-zero dispersion-shifted fiber (ITU-T G655). The MFD is 8 to 10 um at wavelength of 1550 nm. Automatic arc calibration doesn't work in this splice mode. Execute [Arc Calibration] before splicing.
DS FAST	For splicing Dispersion-shifted fiber (ITU-T G653). The MFD is 7 to 9 um at wavelength near 1550 nm. Automatic arc calibration doesn't work in this splice mode. Execute [Arc Calibration] before splicing.

Database of splice mode (Attenuation)

Splice Mode	Description
AT1 (SM)(DS)	[AT1] creates an intentional core axial offset and splices fibers. [AT1] mode provides an estimated splice loss, but this should be regarded as a reference as the estimated splice loss may not be correct in some cases, depending on fiber properties. A power meter is recommended for correct splice loss measurements.
AT2 (SM)(DS)(MM)	This mode allows the users to set a starting core offset value and a finishing core offset value. Set [Start Offset] manually and then splicing starts. Re-arcing is performed continuously / automatically until the axial offset reaches [Stop Offset] value. A splice loss estimate is not performed.

Referring or editing splice mode

Splicing parameters in each splice mode can be modified. Arc power and Arc time are considered the two most vital parameters. To edit parameters follow below steps:

1. In [Select Splice Mode] menu, move cursor to a splice mode to be modified. Press **MENU** key to display [Edit Splice Mode] menu.
2. Move cursor by pressing **Up/Down** Arrow key to a parameter to be changed.

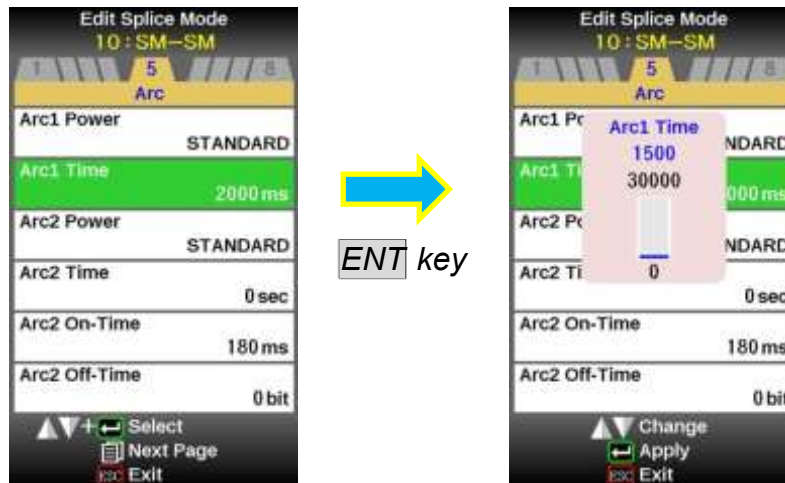

Initialization in the edited parameter

It can perform easily by returning mode to initial setting to return a preset value by package after changing a setup of each parameter.

1. The fiber classification of splice edit mode is chosen by the **ENT** key. Choose the same splice mode within splice mode.
2. Since the following display will come out if the **ENT** key is pressed after selection, Press the **ENT** key after a check.

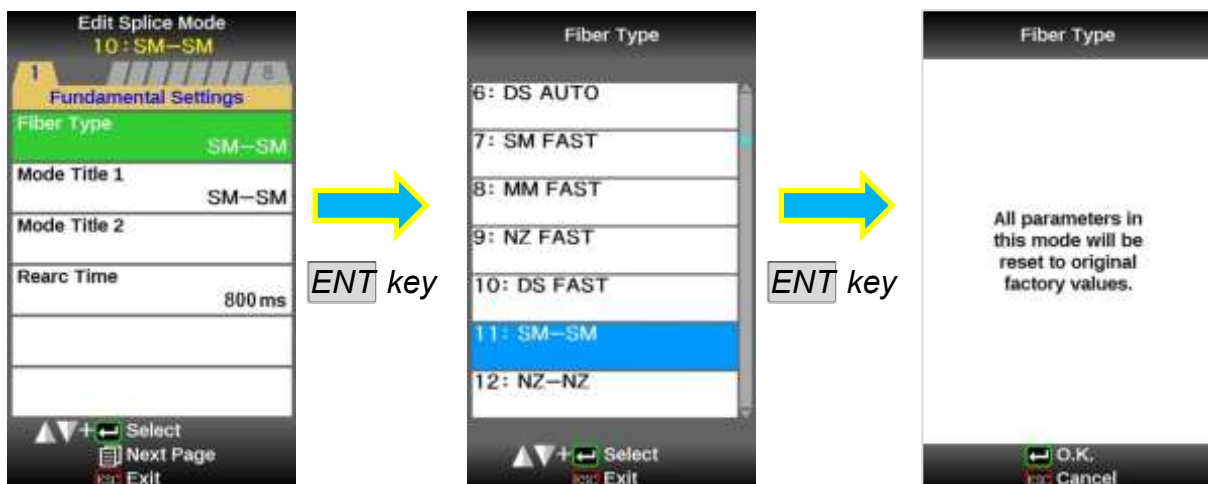

Editing or erasing splice mode

How to create splice mode

There are necessary splice modes stored when the splicer is first delivered, and all the other modes are displayed [BLANK]. Follow the below steps to add a splice mode.

Select a “BLANK” splice mode and press **[MENU]** key. Typical splice modes stored in the splicer database are displayed. Select one splice mode to be copied. Press **[ENT]** key to execute. Press **[ESC]** key to verify the fiber type is named in the specific splice mode.

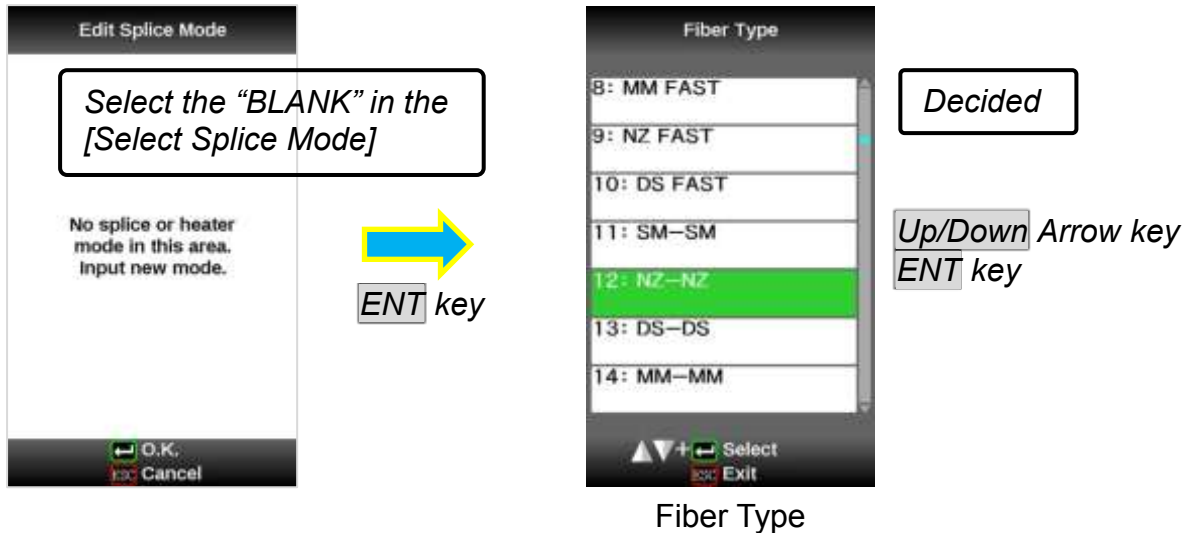

How to erase splice mode

Splice mode can be erased. Follow the below steps to erase splice mode.

1. Select the specific splice mode and press **[SET]** key to go to [Edit Splice Mode] menu. Select [Fiber Type] by pressing **[ENT]** key.
2. Select the “BLANK” and press **[ENT]** key to execute.



- Mode No.1 cannot be erased.
- Mode No.1 is automatically selected after erasing a splice mode.

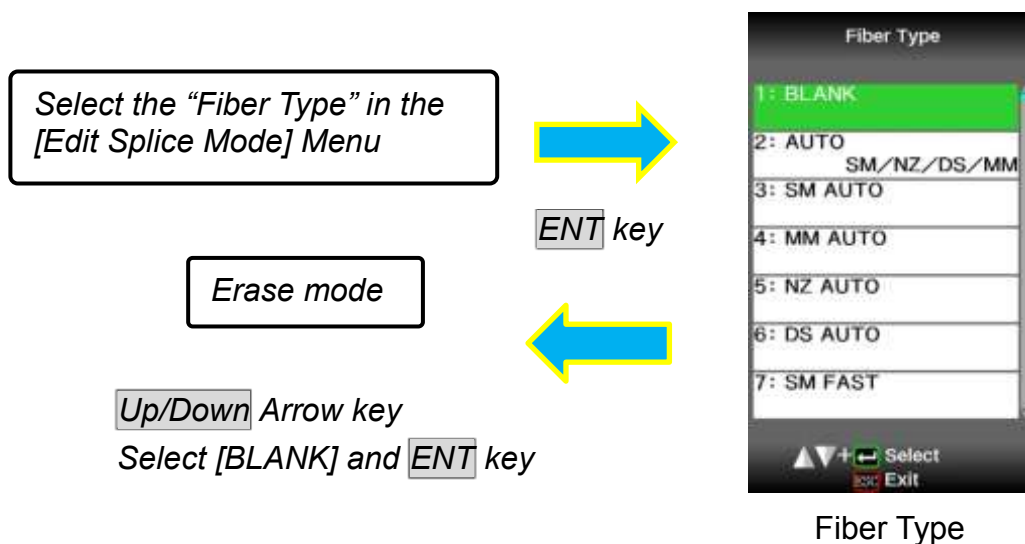

AUTO mode: [SM AUTO]], [MM AUTO]], [NZ AUTO]], [DS AUTO]

Below is a list of Splicing parameters for AUTO modes

Only a limited number of parameters listed below are displayed for AUTO modes to simplify the operation. Additional hidden parameters are all fixed values set at the factory.

Parameter	Description
Fundamental Settings	
Fiber Type	List of splice modes stored in database is displayed. A selected splice mode stored in the database area is copied to a selected splice mode in the user-programmable area.
Mode Title1	Title for a splice mode expressed in up to 11 characters.
Mode Title2	Detail explanation for a splice mode expressed in up to 15 characters. Title2 is displayed at the [Splice Mode Select] menu.
Rearc Time	Splice loss may be improved by an additional "rear" discharge in some cases. The duration of this additional arc can be changed by this parameter.
Arc	
Cleaning Arc	A cleaning arc burns out micro dust on the surface of the fiber with an arc discharge for a short period of time. The duration of the cleaning arc can be changed by this parameter.
Arc Power	The Arc Power is fixed at STANDARD for AUTO modes. The Arc Power is changed automatically.
Arc Time	Arc Time is fixed at 6000ms. This is automatically set depending on the cladding illumination during Arc Discharge.
Error Limit	
Cleave Angle Limit	An error message is displayed if the cleave angle of either the left or right fiber ends exceeds the selected threshold (cleave limit).
Cleave Shape Error	Error message is displayed if the cleaved end face of either left or right fiber exceeds the selected threshold (cleave shape).
Fiber Angle Limit	An error message is displayed if the fiber offset exceeds the selected threshold (Fiber Angle).
Loss Limit	An error message is displayed if the estimated splice loss exceeds selected threshold (loss limit).



➤ Menus change when [Select Splice Mode] is set to [SM], [NZ], [DS] and [MM] mode.

Standard mode: [SM], [NZ], [DS], [MM]

Splicing parameters: standard modes

In other splice modes in the user-selectable database, the user can select from a series of factory-set splicing modes for various splicing combinations. Below are the descriptions of the various parameters used in these modes.

Parameter	Description
Fundamental Settings	
Fiber Type	A list of splice modes stored in the splicer database is displayed. Upon inputting the appropriate mode, the selected splice mode stored in database area is copied to a selected splice mode in user-programmable area.
Mode Title1	Title for a splice mode expressed in up to 11 characters.
Mode Title2	Detail explanation for a splice mode expressed in up to 15 characters. Title2 is displayed at the [Splice Mode Select] menu.
Rearc Time	Splice loss may be improved by an additional "rearc" discharge in some cases. The duration of this additional arc can be changed by this parameter.
Gap Setting	
Cleaning Arc	A cleaning arc burns out micro dust on the surface of the fiber with an arc discharge for a short period of time. The duration of the cleaning arc can be changed by this parameter.
Gap	Sets the end-face gap between the left and right fibers at the time of aligning and pre-fusion discharge.
Gapset Position	Sets the relative position of the splicing location to the center of electrodes. Splice loss may be improved in the case of dissimilar fiber splicing by shifting [Gapset Pos] towards a fiber whose MFD is bigger than the other fiber MFD.
XY Alignment	
Focus-L/R	Sets the focal point for fiber observation. The focal point moves closer to the core when [Focus] value is increased. "Auto" focus is strongly recommended, as [Focus] optimization is very difficult. Left and right fibers are focused independently even if they are a different fiber type (dissimilar fiber splicing). If the fiber core cannot be observed (e.g. MM fiber), use the "Edge" parameter. [Align] and [Est. Mode] are automatically fixed to the "Clad" setting. [ECF] and [Auto Power] are automatically fixed to the "OFF" setting.
Align	Sets the aligning method for the fibers. "Core" : Aligns fibers by core position. "Clad" : Aligns fibers by center position of the cladding of the fiber. "Manual" : Aligns fibers manually.
ECF	Sets the axial offset ratio for ECF. See [ECF Splice] for detail. For a splice mode in which arc time is 5 sec. or longer, setting [ECF] "OFF" is recommended. If [Align] is set to "Edge", "Clad" or "Manual", [ECF] is automatically fixed to "OFF". If [ECF] is set "OFF", [Auto Power] is automatically fixed to "OFF".
Auto Power	Optimizes Arc power according to core concentricity-error. This function is used in combination with ECF. If [ECF] is set to "OFF", [Auto Power] is automatically fixed to "OFF"

A continuation of edit parameter list

Parameter	Description
Prefuse And Stuff	
Prefuse Power	Sets the power of the prefuse arc, which is an arc discharge occurring from the beginning until the fibers begin stuffing. If [Prefuse Power] is set too low, axial offset may occur if cleaved angles are relatively poor. If [Prefuse Power] is set too high, fiber end faces are fused excessively and splice loss gets worse.
Prefuse Time	Sets the duration of the prefuse arc, which is arc discharge occurring from the beginning until the fibers begin stuffing. Longer [Prefuse Time] is synonymous with higher [Prefuse Power].
Overlap	Sets the overlap amount of fibers at the fiber stuffing stage. Relatively small [Overlap] is recommended if the [Prefuse Power] is low, while relatively large [Overlap] is recommended if the [Prefuse Power] is high.
Arc	
Arc1 Power	Arc discharge can be separated into two stages. Arc1 Power is the first stage. This sets Arc1 Power.
Arc1 Time	Sets Arc1 time. Caution If Arc1Time is set 1 sec. or less and Arc2 Power is set to "OFF", the splice may break during proof-test stage.
Arc2 Power	Arc2 is the second arc discharge stage. This sets Arc2 Power.
Arc2 Time	Sets the total Arc2 time. Usually set this value to "OFF". It is possible to set a very long arc time. However, when the total of the Arc 1 time and Arc2 time exceeds 30 seconds, always adjust the function [Arc2 ON Time] and [Arc2 OFF Time] to weaken the arc power. A continuous arc over 30 seconds, without weakening the arc power, may damage the arc discharge unit.
Arc2 On-Time	During Arc2 discharge, arc power can be pulsed by turning the arc on and off. This sets the amount of time that Arc2 is ON.
Arc2 Off-Time	Sets Arc2 OFF Time during Arc2. When the Arc2 discharge is intermittent, re-arc discharge is also intermittent. When continuous re-arc discharge is necessary, set this parameter to "OFF".
Tapering	
Taper Splice	Splice loss is sometimes improved when the fiber is tapered (pulled) during arc discharge to make the splice thinner. This sets taper function "ON". The following three parameters determine the taper shape.
Taper Wait	Sets the taper wait time from the end of fiber stuffing until the start of pulling fiber.
Taper Speed	Sets the fiber pulling speed.
Taper Length	Sets the fiber pulling length.

A continuation of edit parameter list

Parameter	Description
Estimation	
Estimating Mode	Selects splice loss estimation to "OFF" "Clad" "Core" "Core-Fine"
MFD-Left	Sets MFD of the fibers. This MFD value is taken into account for estimating splice loss.
MFD-Right	
Minimum Loss	This amount is added to the estimated splice loss originally calculated. When splicing specialty or dissimilar fibers, a high actual splice loss may occur even with optimized arc conditions. To make the actual splice loss concur with the estimated splice loss, set the minimum value of estimate to the minimum optimized actual splice loss.
Wave Length	Set up is wave length.
Core Bending Coef.	The influence which it has on an estimation loss value is set up. Adjust a value, when you unite an estimated loss.
MFD Mismatch Coef.	Determines how Core step, Core curve and MFD mismatch influences splice loss estimate. If Est. Mode is set "OFF" or "CLAD", these Core step, Core curve and MFD mismatch are automatically set "OFF". If the estimated splice on certain fiber combinations needs adjustment, Core step, Core curve and MFD mismatch are used. These are advanced splicer functions and should be discussed with you authorized distributor before changing.
Error Limit	
Cleave Angle Limit	An error message is displayed if the cleave angle of either the left or right fiber ends exceeds the selected threshold (cleave limit). "OFF": Does not make judgment on cleave angle.
Cleave Shape Error	Error message is displayed if the cleaved end face of either left or right fiber exceeds the selected threshold (cleave shape). "OFF": Does not make judgment on cleave shape.
Fiber Angle Limit	An error message is displayed if the bend angle of the two fibers spliced exceeds the selected threshold (Fiber Angle Limit). "OFF": Does not make judgment on fiber angle.
Loss Limit	An error message is displayed if the estimated splice loss exceeds selected threshold (loss limit).



- Menus change when [Select Splice Mode] is set to [SM AUTO], [NZ AUTO], [DS AUTO] and [MM AUTO] mode.

Manual Splice Mode

This mode is to manually align and splice fibers. The following procedure is required, and is different from standard automatic splicing.

1. Select a splice mode that allows the splice parameter [Align] in page two of splice mode edit menu to be changed to "manual" (i.e. SM-SM mode).



2. Press **SET** key to drive the fibers forward. The fibers stop moving forward at the Gapset position.
3. Select a motor to be manually moved by pressing **MENU** key. The name of the motor to be moved is displayed in the monitor. Motor speed can be selected "fast" or "slow" by pressing **SET** key.
4. Press **Up/Down** Arrow key to move the selected motor and drive the fibers forward or backward.
5. After manual alignment is completed, press **ARC** key to arc and splice the fibers.



- The splicer beeps if motor reaches its limit and stops. Press the opposite arrow key to move the motor again.
- Display messages can be erased by pressing **ENT** key. The message can be displayed by pressing **ENT** key again.

Motor	Up Arrow key	Down Arrow key
ZL/ZR	Forward	Backward
X/Y	Upward	Downward
Focus X Focus Y	Lens moves nearer fiber.	Lens moves away from fiber.

ECF Splice

When fibers having some core concentricity-error are aligned using the core-to-core method, their outer claddings are not aligned in line with each other as shown below. However, surface tension created during arc discharge aligns the fibers cladding-to-cladding due to the viscous self-centering effect. This results in a high splice loss due to the fact that the cores of the fibers are offset during the process.

The ECF (Eccentricity Correct Function) function in the splicer prevents this from happening. The amount of offset expected due to this surface tension phenomenon is calculated in advance, and this is taken into account to determine an intentional core axis offset amount that is added after the fiber cores are aligned. With this function, the fibers are core-to-core spliced even with the effect mentioned above. Some "Core step" may remain at splice point but this gives much lower splice loss than core axial offset. A long arc discharge counteracts ECF, because surface tension eventually aligns and splices fibers cladding-to-cladding. Canceling [ECF] by setting this "OFF" reduces core step amount and increases core axial offset.

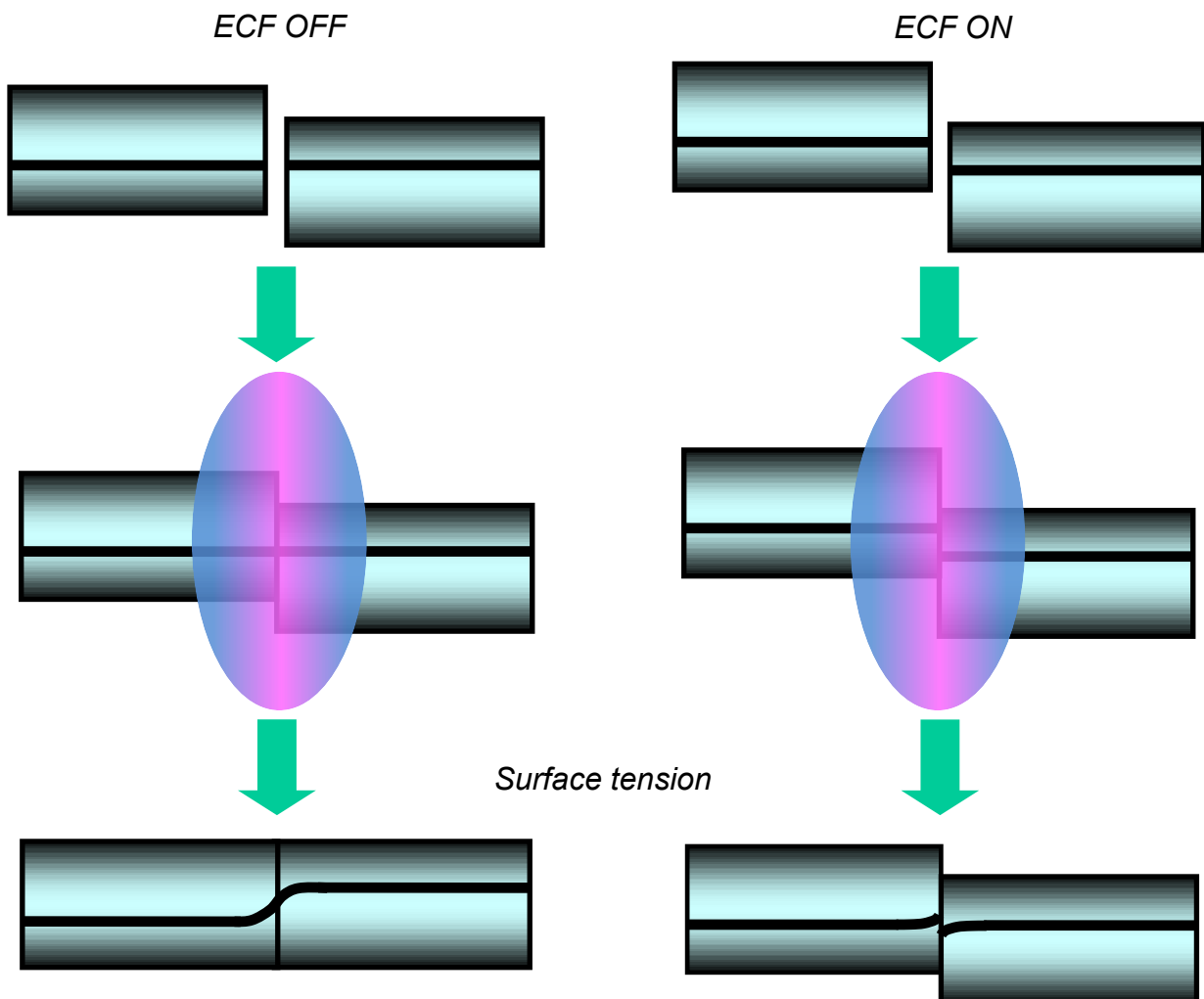

Attenuation splice mode

Attenuation splice mode makes an intentional core axial offset to create attenuation at the splice point. Two types of attenuation splice modes are included in the splicer as stated below. Select either "AT1(SM)", "AT1 (DS)", "AT2(SM)", "AT2 (DS) or AT2 (MM) in data base area at [Fiber Type].

[AT1] mode

[AT1] creates an intentional core axial offset and splices fibers. [AT1] mode provides an estimated splice loss, but this should be regarded as a reference as the estimated splice loss may not be correct in some cases, depending on fiber properties. A power meter is recommended for correct splice loss measurements.

Splicing parameters

Parameter	Description
Target Loss	Sets target splice loss.
Coefficient	If actual splice loss measured does not match [Target Loss], the "coefficient" can be used to adjust this. This is often more practical than "Target loss" or "MFD" in terms of accuracy.
MFD-Left MFD-Right	Sets MFD of fibers to be spliced.
Other Parameters	Refer to other splice modes for complete description.

[AT2] mode

This mode allows the users to set a starting core offset value and a finishing core offset value. Set [Start Offset] manually and then splicing starts. Re-arc is performed continuously / automatically until the axial offset reaches [Stop Offset] value. A splice loss estimate is not performed.

Splicing parameters

Parameter	Description
Start Offset	Sets axial offset amount before splicing.
Stop Offset	Re-arc is continuously performed until axial offset reaches specific offset amount [Stop Offset]. Axial offset amount decreases as splicing occurs, so [Stop Offset] must always be smaller than [Start Offset]. The maximum amount of [Stop Offset] is 80% of [Start Offset].
Other Parameters	Refer to other splice modes for complete description.



- [AT2] mode provides more stable performance than [AT1] mode, but some variation may inevitably occur. To decrease variation, set the [Cleave Limit] as low as possible.
- Attenuation splices made with [AT1] / [AT2] modes are not as accurate as power meter attenuation feedback splicing.
- [AT2 (MM)] mode is for attenuation splicing with MM fiber. Cladding alignment is performed with [AT2 (MM)] mode.

Splice Settings

Common parameters for all the modes for splicing can be set.

1. Press **MENU** key in [READY], [PAUSE], and [FINISH] state to display [Splice Menu].
2. Select [Splice Settings] in [Splice Menu] to display [Splice Settings] menu.
3. Select a parameter to be changed. Press **ENT** key to change values.
4. Change value by pressing **Up/Down** key, then press **ENT** key to enter.

Splicing Settings parameters

Parameter	Description
Splice Operation	
Operation Mode	Automated wind-protector has several operation modes. Operation procedure after splicing can be selected.
Pause1	If "Pause 1" is set to "ON", splicing operation pauses when fibers are forwarded to gap-set position. Cleave angles are displayed during the pause.
Pause2	If "Pause 2" is set to "ON", splicing operation pauses after fiber alignment is completed. With ECF "ON", core-to-core alignment is made after this pause.
Auto Cover Open	Automatically wind-protector opens.
Fiber Image on screen	
Gapset	Sets the method of displaying the fiber image on the screen during Splicing operation.
Align	
Arc	
Estimate	
Estimate	
Pause1	Sets the method of displaying the fiber image on the screen during Splicing operation.
Pause2	
Finish	
Finish	
Ignore Splicing Error	
Loss	Setting to "Disable" prevents the splicer from finishing its operation. Splice loss estimation is not displayed; operator must press reset to continue.
Bubble	
Fat	
Thin	
Dust Burned	
Cleave Angle	Setting to "Disable" prevents the splicer from continuing splice sequence, requires operator to re-prep fibers.
Cleave Shape	
Fiber Angle	
Others	
Max Num. of Rearcs	The re-arc process sometimes improves the splice loss, but sometimes worsens it. Re-arc decreases the splice strength. With this function, it is possible to limit the number of re-arcs or to disable re-arc discharge.

Memory

This splicer stores up to 2,000 splicing results. Contents of data stored are different depending on splicing mode.

Splice Results Reference or Elimination

Splicing results stored in the memory can be displayed. Comments can be added or edited.



- Memory Data can be downloaded by USB. Refer to instruction manual of "Data Connection".

How to display the splice Result data

1. Select [Memory] in [Splice Menu] and select [Splice Results] and press **ENT** key to display [Splice Results] Menu.

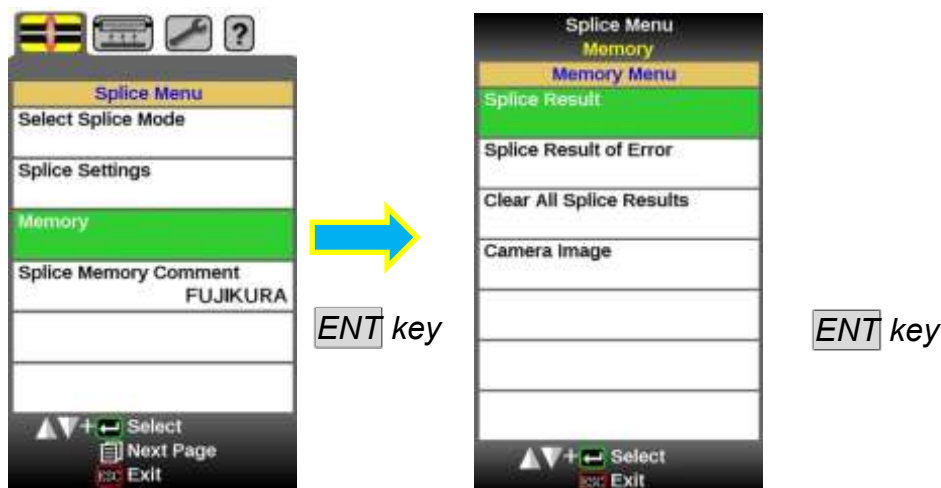

2. Splice memory is displayed.
3. Select memory number by moving cursor to a specific memory number and press **ENT** key. The selected splicing result is displayed. Press **MENU** key to select a [Jump /Remove] option. Select the oldest data or Latest data by pressing **Up/Down** Arrow key. This can be removed by pressing **ENT**.
4. The selected splicing result is displayed. For adding or editing comments, press **ENT** key to display [Input Comment] screen.

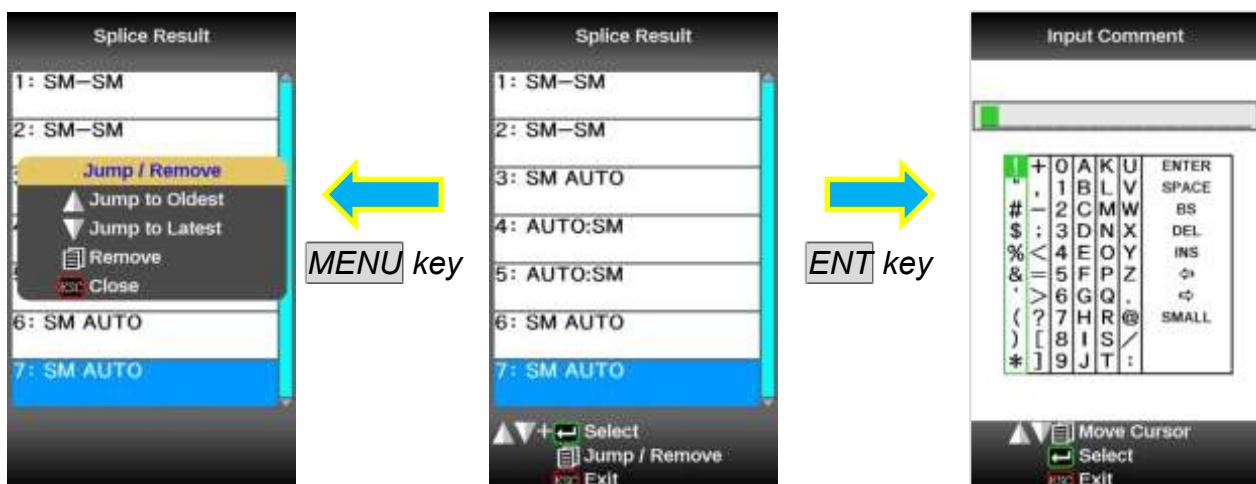

How to Clear the Splice Results data

1. Press **MENU** key in [Splice Result] Menu.
2. Press **MENU** key in [Jump / Remove] Menu.
3. Select the first data in the range to be deleted by **ENT** key.
4. Select the last data in the range to be deleted by **Up/Down** arrow key.
5. Press **ENT** key to select the highlighted range. Press **ENT** key to delete the memory.



How to display the splice Result of error

Only the memory which the error generated like the splice result memory display method can be displayed.

1. Select the splice result of error by pressing **ENT** key.
2. Only a memory with an error is displayed.

Clear All Splice Results

All splicing results can be cleared at once.

1. Move cursor to [Clear All Splice Result] in Memory Menu. And Press the **ENT** Key.
2. Press **ENT** key to display [Clear All Splice Result].

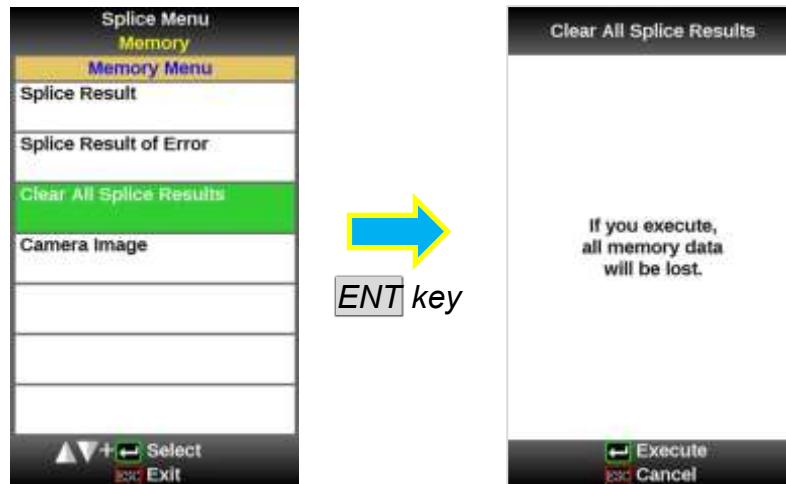

Clear All Splice Results

Camera Image

This function is used to store the fiber image after splice or error occurred. A total of 100 images can be stored.

1. Select [Memory] in [Splice Menu].
2. Select [Camera Image] and press **ENT** key to display [Camera Image] Menu.

How to store the Camera Image Data

Select [No Image] by moving cursor to a specific memory number and press **ENT** key. The fiber image data is stored.



- Max number of image storage is 100, and the image cannot be over-written, so delete some images to store new images.

How to display Camera Image Data

Select memory number by moving cursor to a specific memory number and press **ENT** key. The fiber image data is displayed.

How to delete Camera Image Data

Select the number in [Camera Image] and press the **MENU** key. The confirmation screens are displayed, and then press **ENT** key.

Splice Memory Comment

The splicing result is automatically stored in memory when **SET** or **RESET** is pressed upon completion of the splice at the [Finish] screen, or when the wind-protector is opened upon completion of the splice at the [Finish] screen. Once a comment is entered, the same comment is used for subsequent splice results.

At the time of shipment from factory, there is no comment inputted.

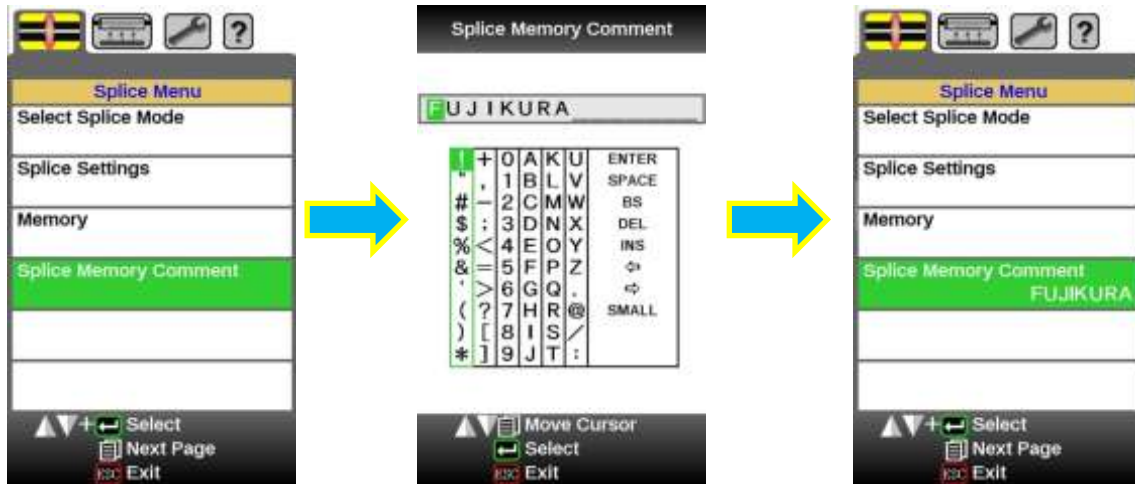

Select Heater Mode

Each tube-heating mode is optimized for a type of Fujikura protection sleeve. These modes can be found in database area for reference. Copy the appropriate one and paste it to the user-programmable area. The operator can edit the user-programmable modes.

Data Base

Parameter	Description
60mmS FP-03	For standard 60mm protection sleeve, Such as Fujikura FP-03 or FP-03M protection sleeves.
40mmS FP-03(L=40)	For standard 60mm protection sleeve, Such as Fujikura FP-03(40mm) or FP-03M protection sleeves. Note : Cleave length 8mm.
40mmR FP-04T	For standard 40mm protection sleeves, Such as Fujikura FP-03 (L=40).
15mmS FPS01-400-15	For 400 or less um of diameters of coating and splice of the interference length of 5 mm or less
20mmS FPS01-900-20	For 900 or less um of diameters of coating and splice of the interference length of 6 mm or less
60mmS FPS01-DC-60	For Splice of a drops cable.
28mmS FC-SC-**-30/20	For Fuse connect splice.
45mmS FC-SC-**-09	

The dimensions of the Protection Sleeve after shrink

Form	Tension member	Sleeve length	Prepare fiber length	Diameter of an adaptation optical fiber	Diameter of a result
FP-03	SUS	60mm	16mm or less	250~900um	3.1mm
FP-03(40mm)	SUS	40mm	10mm or less	250~900um	3.1mm
FP-04T	Glass Ceramic	40mm	10mm or less	250~900um	4.0mm
FPS01-400-15	SUS	15mm	5mm or less	~400um	1.5mm
FPS01-900-20	SUS	20mm	6mm or less	~900um	2.3mm

* The dimensions of the protection sleeve after shrink vary depending on the diameter of the fiber.

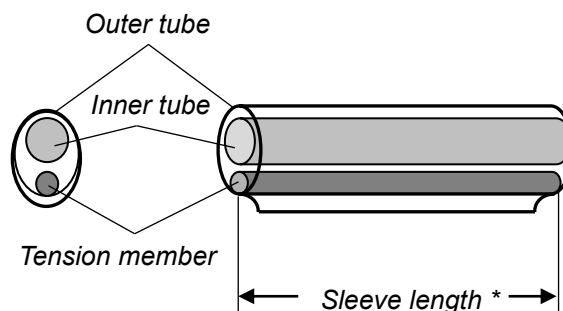

Selecting Heater mode

Select the heater mode most suitable for the protection sleeve to be used.

1. Press **MENU** key in [READY], [PAUSE], [FINISH] state and press **MENU** key to display [Heater Menu].
2. Select [Select Heater Mode] in [Heater Menu]. [Select Heater Mode] menu is displayed.
3. Move cursor by pressing **Up/Down** Arrow key and press **ENT** key to select a heater mode.

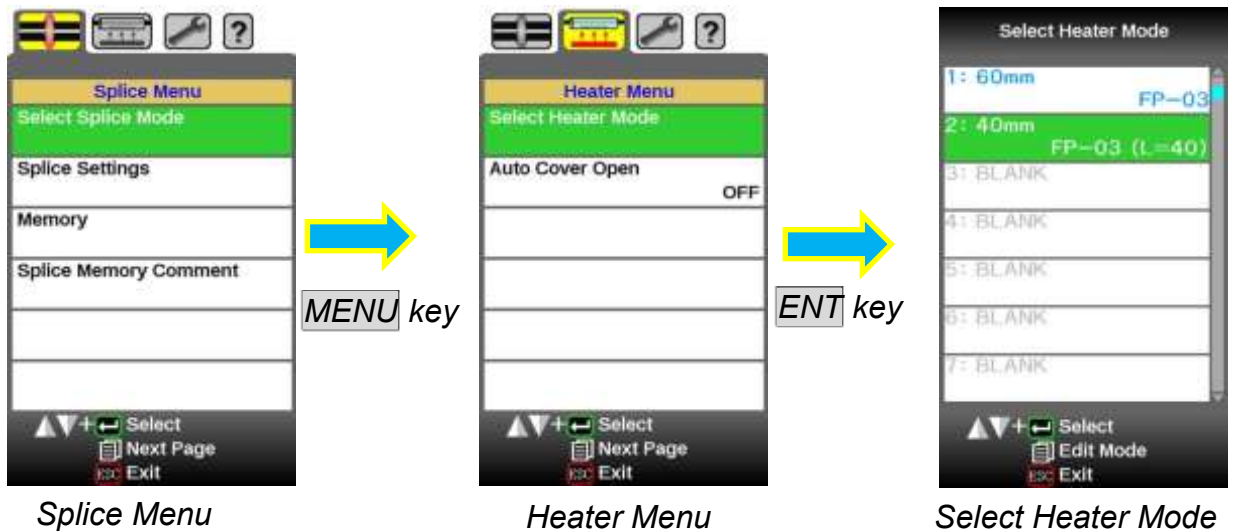

4. The check in the heater mode selected on the OK screen can be performed.



- When using a protection sleeve which is not made by Fujikura, please set parameters based on the specific sleeve.
- When the sleeve of another company is used, the durability of a protection point cannot be warranted.

Referring to or Editing Heater Mode

Tube-heating conditions stored in heater mode can be edited or changed.

1. Move cursor and select a mode to be edited in [Select Heater Mode] menu. Press **MENU** key to display [Edit Heater Mode] menu.
2. Press **Up/Down** Arrow keys to move cursor to a parameter to be changed then press **ENT** key to enter.
3. Change value by pressing **Up/Down** key, then press **ENT** key to enter.

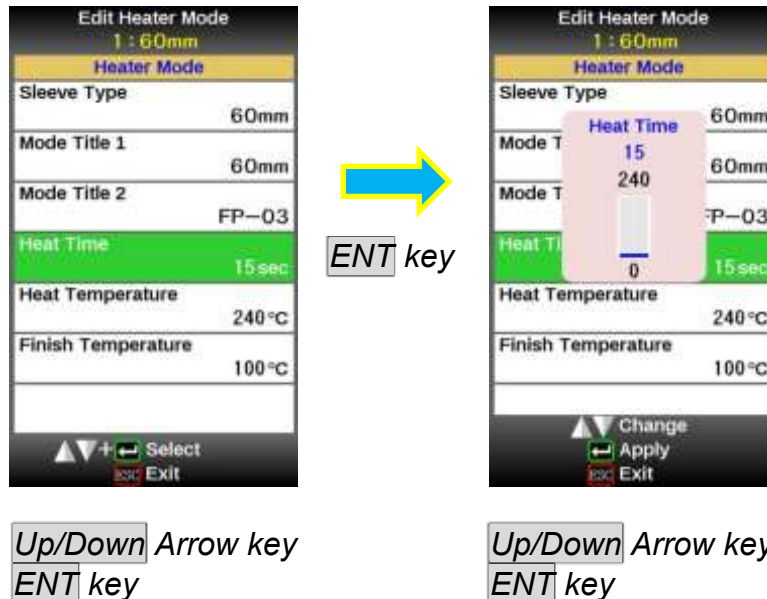

Heater mode parameters

Parameter	Description
Sleeve type	Sets sleeve type. List of all heating modes are displayed. Select a mode in the list and this is copied to a user-programmable mode.
Mode Title1	Title of a heater mode that is displayed in the lower right part of the monitor during the splicing/heating process. Max number of characters used is 7.
Mode Title2	Description of a heater mode in the [Sleeve Type] screen. Max number of characters used is 15.
Heat Time	Sets heating time from the beginning to the end (cool-down completion). Heating time is automatically adjusted with atmospheric conditions, such as ambient temperature. Heating time may be longer or shorter than [Heat time] set.
Heat Temperature	Sets heating temperature.
Finish Temperature	Sets the finish temperature. The buzzer beeps after completion of the heating. Caution Do not touch the shrunken sleeve after removing the fiber from the tube heater. It may be hot. Hot sleeves easily deform and can cause some residual stress at the splice point. Use J-plate to cool down the sleeve.

About heating of a connector splice part

The heater of this splicer corresponds to connector.

It can be used for connectors from other companies by changing the sheath clamp portion, and the heating operation can be performed easily.

Exchange of a heater clamp

1. Remove the rear screw of the heater.



2. Clamp unit is made to slide and exchanged for other size.



When using Fujikura Fuse Connect, removing the clamp is unnecessary. Heating contraction work can be done in the usual state.

*The sleeve position may need to be shifted prior to heating.

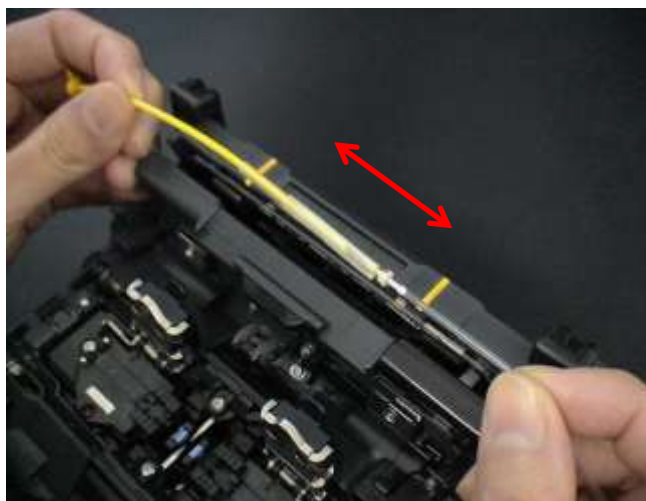

Maintenance Menu information

The splicer has the ability to perform routine maintenance. This section describes how to use the maintenance menu.

1. Press **MENU** key in [READY], [PAUSE] or [FINISH] state. Press **MENU** key to display [Maintenance]. Select the [Maintenance Menu] press **ENT** key.
2. Select a function to perform.



Replace Electrodes

When the number of arc discharges reaches a count of setting value a message prompting to replace the electrodes is displayed immediately after turning on the power. Using the worn electrodes will result in greater splice loss and reduced splice strength.

Replacement Procedure

1. Execute [Replace Electrodes] in [Maintenance Menu].
2. Instruction messages will appear on the screen to turn off the power. Press and hold **ENT** key till the LED color changes from green to red.
3. Remove the old electrodes.



To remove and replace the electrodes:

- i. Remove the electrode cover and loosen screw located on electrode holder.
- ii. Take electrode out of electrode holder. (Electrode is fit in electrode holder)

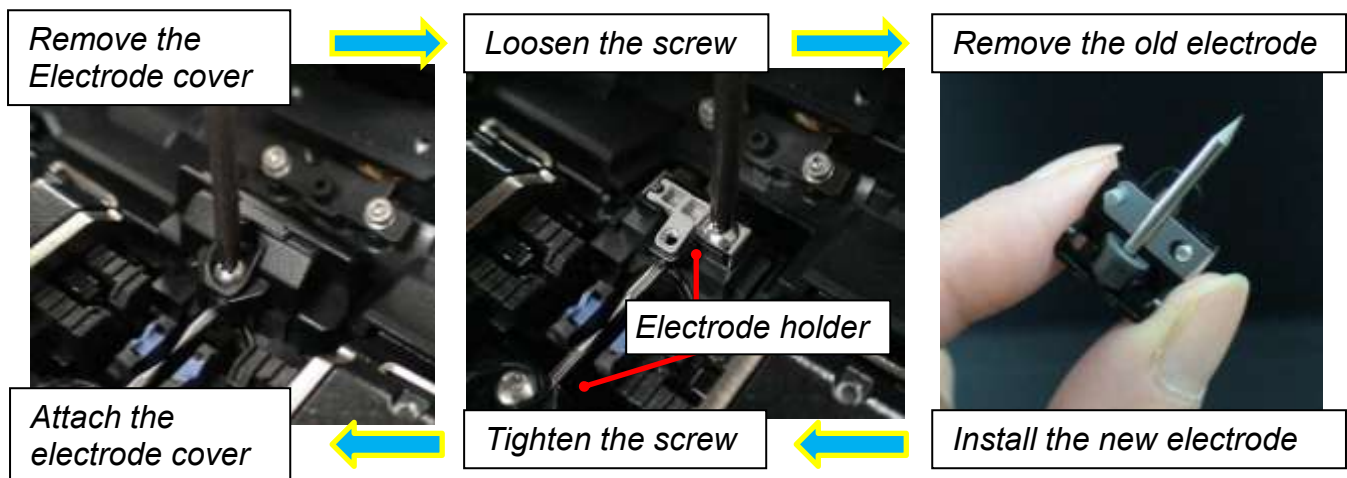

4. Install the new electrodes with care; do not hit the electrode tips.
 - i. Fit the electrode in the electrode holder.
 - ii. Place the electrode holder on the splicer and tighten screw.



- Apply tightening torque of 200CNm when tightening screw to fix electrode.
- Make sure the electrodes are attached firmly after tightening screws.

5. Turn on the power, prepare fibers into the splicer and press **ENT** key. After executing the arc calibration, the splicer will repeat arc discharge to stabilize the electrodes.
6. Upon completion of repeated arc discharge, the splicer executes an arc calibration again. The operator should repeat arc calibration until the “Test Finish” message appears. For details of the arc calibration process, see section [Arc Calibration].

Stabilize Electrodes

In the event of sudden change in environmental conditions, etc., the arc power sometimes becomes unstable, resulting in higher splice loss. Especially when the splicer is moved from lower altitudes to higher altitudes, it takes time for the arc power to stabilize. In this case, stabilizing electrodes will expedite the process of making the arc power stable. If many tests are needed until the “Test OK” message appears in [Arc Calibration], use this function as well.

Operation Procedure

1. Select the [Stabilize Electrodes].



2. Set the prepared fibers in the splicer.
3. Press **ENT** key and the splicer begins to stabilize the electrodes in the following ways:
4. After completing stabilization, always perform an additional [Arc Calibration].

Clear Arc Count

This function enables the stored number of arc discharges to be reset.

1. Select the [Clear Arc Count].
2. As the confirmation screen “Is it OK to clear?” appears, press **ENT** key to clear.



- This function is included in the [Replace Electrodes] function.
- The number of arc discharges in the “Total Arc Count” field displayed on the [Maintenance Info.] screen cannot be reset.

Clear Cleaver Counter

This function was the stored number of [Cleaver Counter] to be reset.

1. Select the [Clear Cleaver Counter].
2. As the confirmation screen “Is it OK to clear?” appears, press **ENT** key to clear.

Parameter	Descriptions
Cleave Count	The number of times of cleave is displayed.
Blade Position	The position of a blade is displayed.
Blade Height	The height of a blade is displayed.

It performs, after adjusting Cleaver who is using it.

Motor Drive

The two motors incorporated in the splicer can be manually operated individually. In the course of splicing, the motors can also be operated by calling this menu in the [PAUSE], or [FINISH] state.

1. Select the [Motor Drive].
2. Pressing **MENU** key changes motor selection. The name of the selected motor is displayed in the upper section of the screen.
3. Press **Up/Down** Arrow key to drive the motor in the desired direction.

Motor	Up Arrow key	Down Arrow key
ZL/ZR	Forward	Backward
X/Y	Upward.	Downward.
Focus X/Y	Lens moves nearer fiber.	Lens moves away from fiber.



- When the motor reaches the limit of the operating range, the buzzer sounds and the motor stops. Press the opposite arrow key to reverse and move the motor again.
- Display messages can be erased by pressing **ENT** key. The message can be displayed by pressing **ENT** key again.
- If the motor is moved too much with respect to the spliced fiber, the fiber may break.

Diagnostic Test

The 70S has a built in diagnostic test feature that allows the operator to perform a simple one step evaluation of splicer performance covering several different critical variables. Perform this function in the event of splicer operation trouble.

Operation Procedure

Check Item	Description
LED Check	Measures and adjusts the brightness of the illumination LED.
Dust Check	Checks the optical path for dust or dirt and judges whether they disturb fiber observation. If contamination exists, this function indicates the location.
Motor Check	Check the Motor Limit Sensor.
Motor Calibration	Check the Motor Calibration.
Arc Calibration	Automatically calibrates the arc power factor and fiber splicing position.
I/O Port Check	Checks for normal operation of the input and output terminals of the internal circuit.
Memory Check	Checks the memory of the internal circuit.

1. Select the [Diagnostic Test] in the [Maintenance Menu] and execute [Diagnostic Test]. The following checks will be made.



- Before the start of the test, remove the fibers from the splicer.
- When the Motor check is completed, prepare and load the fibers into the splicer and press **ENT** key.

2. Upon completion of all checks and adjustments, a list of results is displayed. If the dust check result is not good, clean the objective lenses. In the case that cleaning cannot eliminate contamination, there is a possibility that the contamination may have entered the inside of the optical path. Please contact the authorized distributor for additional instructions.

The dust check and Motor Calibration functions exist as independent instructions in [Maintenance Menu]. It is possible to execute them independently.

Dust Check

The splicer observes fibers through image processing. Dust or contaminants on the cameras and lenses cover disturb normal observation of fibers and may result in improper splicing. This function checks the optical path for the presence or absence of contaminants and judges whether they cause trouble for fiber splicing.

Operation Procedure

1. Select the [Dust Check] in the [Maintenance Menu].
2. If fibers are set in the splicer, remove them and press **ENT** key again. The splicer begins the dust check.
3. After observation, the location of contamination judged as a potential problem blinks. If contamination is discovered, clean the objective lenses cover and redo [Dust Check] for cleaning instructions.
4. Press to finish dust check.

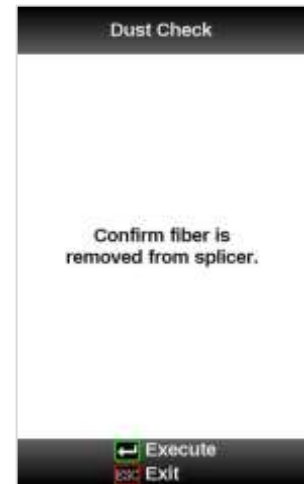

- In case you have cleaned the objective lenses cover, and dirt or dust still remain, contact the authorized distributor.

Arc Calibration

Atmospheric conditions such as temperature, humidity, and pressure are constantly changing, which creates variability in the arc temperature. This splicer is equipped with temperature sensor that is used in a constant feedback monitoring control system to regulate the arc power at a constant level. Changes in arc power due to electrode wear and glass adhesion cannot be corrected automatically. Also, the center position of arc discharge sometimes shifts to the left or right. In this case, the fiber splicing position has to be shifted in relation to the arc discharge center. It is necessary to perform an arc power calibration to eliminate both of these issues.



- Arc calibration is performed automatically using [AUTO] mode only. So arc calibration does not have to be performed when splicing in this mode.
- Execute [Arc calibration] before using non-auto mode.
- When Performing the [Arc Calibration] function change the arc power "factor" value. The factor value is used in the algorithm program for all splicing. The arc power value will not change in the splice modes.

Operation procedure

1. Select [Arc Calibration] in [Maintenance Menu] to display Arc Calibration screen.
2. Set prepared fibers onto the splicer.

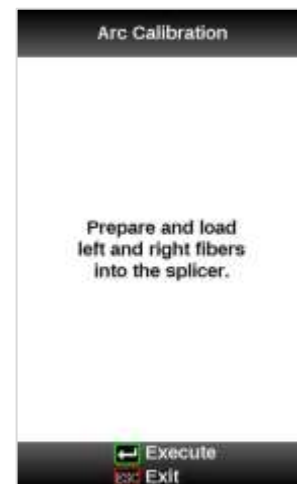

- Use standard SMF ITU-T G652 fiber for Arc Calibration.
- Use well prepared fibers for arc calibration. Dust on the fiber surface affects arc calibration.
- Cleave angle threshold does not link to the parameter "Cleave Limit" in splicing modes. Cleave angle threshold is independently set for arc calibration. See section [Machine Settings] to change cleave angle threshold.

3. The ARC Calibration after pressing **ENT** key.

“Good” message

Arc power and splicing position calibration are successfully completed. Press **ESC** key to exit.

Result: Good

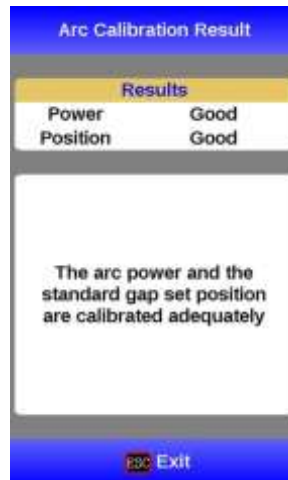

“Not Adequate” message

Arc power and splicing position calibration are completed but further calibration is strongly recommended, as the change from the previous arc calibration is too large. Press **ENT** key to perform arc calibration, or **ESC** key to exit even though arc calibration is not completed.

Result: Not Adequate

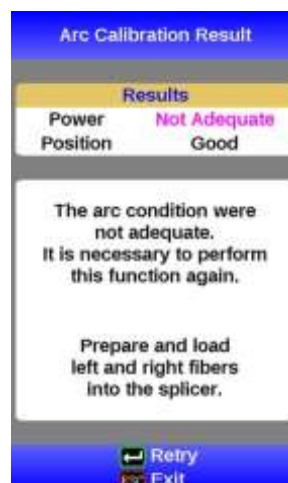

- In some cases, multiple iterations of arc calibration are needed until the calibration process is successfully completed and the "Test Finish" message is displayed. Arc calibration can be considered almost completed if multiple iterations are completed without receiving the message.
- Number threshold can be set so that "Test Finish" message is displayed after specific number of arc calibrations is performed. See section [Machine Settings] for detail.

Motor Calibration

Motors were adjusted at the factory before shipping. However, settings could change due to various reasons. This function automatically calibrates the speed of all motors.

Operation Procedure

1. Select the [Motor Calibration] in the [Maintenance Menu].
2. Load prepared fibers in the splicer and press **[ENT]** key.
3. Speeds for all motors are automatically calibrated. Upon completion, [Maintenance Menu] is displayed.



➤ Perform this function when "Fat" or "Thin" error has occurred.

Maintenance Info

The maintenance information on this equipment can be checked.

Maintenance Info.	
Serial Num.	*****
Version	**.*
Arc Count	65
Total Count	179
Last Authorized Service	2008.01.01
Next Authorized Service	2009.01.01

Maintenance Info.	
Cleave Count	0
Blade Position	0
Blade Height	Low
Power Source Type	Battery Pack

Select the [Maintenance Info]. The following information is displayed.

Parameter	Description
Serial Num.	Displays the serial number of the splicer.
Version	Displays the version number of the software.
Arc Count	Displays the number of arc discharges after electrode replacement. Performing the function [Replacements Electrode] or [Clear Arc Count] resets this parameter to zero.
Total Count	Displays the total number of arc discharges.
Last Authorized Service	Displays the date of last authorized service.
Next Authorized Service	Displays the scheduled date of next authorized service.
Cleave Count	Displays the total number of Cleave Count.
Blade Position	Displays the current Blade Position.
Blade Height	Displays the current Blade Height.

Machine Settings

The parameter about warning and a maintenance item can be changed.

1. Select [Machine Settings] in [Maintenance Menu] to display [Machine Settings] menu.
2. Select a parameter to be changed. Press **ENT** key to change values.
3. Change value by pressing **Up/Down** key, then press **ENT** key to enter.

Available to set the parameters about warning and maintenance item.

Parameter	Description
Basic Settings	
Language	Sets a language to be displayed on the screen. Select a language to be displayed. The language that can be displayed changes by a software version and region code.
Buzzer Volume	Sets the sound volume of the buzzer.
Monitor Position	Sets the operational direction of splicer. [Front] is for front monitor operation. [Rear] is for rear monitor operation. [Auto] is switched to front monitor operation or rear monitor operation automatically. Refer to next page for detail.
Power Saving Timer	
Sleep(Battery)	Setting Sleep function turns off the power supply to the LCD Monitor if the splicer performs no operation after a certain period of time. Automatically turns off the power supply to the splicer if it performs no operation for a certain period of time. The function serves to prevent the battery capacity from running low if the splicer is left on for an extended period of time.
Shut Down(Battery)	
Sleep(AC)	
Shut Down(AC)	
Power On Option	
Opening Title 1	Sets the message to be displayed when the splicer power is turned on. Max number of characters: 15
Opening Title 2	
Electrode	
Electrode Caution	When the number of splices exceeds the selected [Electrode Caution] value, the caution message prompting the operator to replace the electrodes is displayed when the splicer power is turned on.
Electrode Warning	
Cleave Blade Arm	
Blade Position Change	ON/OFF setup of the warning of the Cleaver counter can be performed. In OFF, warning is not indicated on a screen.
Blade Height Change	
Blade Replacement	
Arc Calibration	
Cleave Limit	Sets the threshold of cleave angle error for the [Arc Calibration].
Max Number of Tests	Sets the number which ends an inspection compulsorily for the [Arc Calibration].

Supervisor Menu

Supervisor Settings: Used for Administrator to limit operator from selecting or changing certain functions.

Parameter	Description
Supervisor Settings	
Calendar	This function sets the date and time in the calendar
Supervisor Password	Password setup of Enter Supervisor password.
Boot Password	Password setup of Enter Boot password.
Enter Boot Password	Setting to Enter Boot Password ON/OFF.

Menu Lock Settings	
Parameter	Descriptions
Splice Mode	
Select Splice Mode	Setting to "Disable" prevents unauthorized editing and selecting of splice modes.
Edit Splice Mode	
Heater Mode	
Select Heater Mode	Setting to "Disable" prevents unauthorized editing and selecting of heater modes.
Edit Heater Mode	
Memory	
Clear All Splice Results	Setting to "Disable" prevents unauthorized erasing of splice result data on the memory.
Splice Settings	
Splice Operation	[Splice Settings] Menu cannot be edited if this is set to "Disable".
Ignore Splicing Error	
Fiber Image on Screen	
Others	
Machine Settings	
Basic Settings	Setting to "Disable" prevents unauthorized editing of the [Machine Settings] menu.
Power Saving Timer	
Power On Option	
Electrode	
Clear Cleaver Counter	
Arc Calibration	
Maintenance Menu	
Replace Electrodes	Setting to "Disable" prevents operation of various functions related to the [Maintenance Menu].
Stabilize Electrodes	
Clear Arc Count	
Clear Cleaver Counter	
Motor Drive	
Diagnostic Test	
Dust Check	
Arc Calibration	
Motor Calibration	

Error Message List

Press **ENT** when an error is shown on the monitor. The **[HELP]** screen displays the following:

- If error does not have an error code, such as “Cleave Shape NG”, the keystrokes are displayed with information explaining what each keystroke does if pressed.
- If error has an error code, additional information according to the Error Code and Message is displayed.

Follow the solution precisely as shown in the list below. If it is not possible to eliminate the problem, the splicer may require service by a qualified service center. Consult the authorized distributor with the following information:

- Model name of the splicer
- Serial number of the splicer
- Error message
- Error code (if shown)
- Situation when the error occurs

Error Message	Reason	Solution
L-Too Long Fiber	<ul style="list-style-type: none"> ·The cleave length (bare fiber part) is too long. ·Dust or dirt is on the objective lens or the wind-protector mirror. 	<ul style="list-style-type: none"> ·Confirm the setting position of the stripped fiber end on the fiber cleaver. Check the cleave length. ·Execute the [Dust Check]. Clean the lens or the mirror when dust or dirt exists.
R-Too Long Fiber		
LR-Too Long Fiber		
X-Dark Back Ground	<ul style="list-style-type: none"> ·Dust or dirt is on the objective lens or the wind-protector mirror. 	<ul style="list-style-type: none"> ·Execute the [Dust Check]. Clean the lens or the mirror if dust or dirt exists.
Y-Dark Back Ground		
X-Dark Back Ground	<ul style="list-style-type: none"> ·The LED or Camera might be damaged. 	<ul style="list-style-type: none"> ·Consult the authorized distributor.
Y-Dark Back Ground		
L-Too Dusty Fiber	<ul style="list-style-type: none"> ·Dust or dirt is on the fiber surface. ·Dust or dirt is on the objective lens. 	<ul style="list-style-type: none"> ·Completely prepare the fiber again (strip, clean and cleave). ·Execute the [Dust Check]. Clean the lens if dust or dirt exists.
R-Too Dusty Fiber		

Error Message List

Error Message	Reason	Solution
ZL Motor Overrun (Forward)	<ul style="list-style-type: none"> •The fiber is not set correctly at the bottom of the V-groove. The fiber is not located in the Camera's field of view. •The cleave length (bare fiber part) is too short. 	<ul style="list-style-type: none"> •Press RESET key, and set the fiber again to seat it correctly at the bottom of the V-groove. •Confirm the setting position of the stripped fiber end on the fiber cleaver. Check the cleave length.
ZR Motor Overrun (Forward)		
ZL Motor Overrun (Backward)	<ul style="list-style-type: none"> •The taper speed or taper time is set too high. 	<ul style="list-style-type: none"> •Adjust the taper parameters in the splice mode.
ZR Motor Overrun (Backward)	<ul style="list-style-type: none"> •Only occurs in manual motor operation. 	
X motor Overrun	<ul style="list-style-type: none"> •The fiber is not set correctly at the bottom of the V-groove. The fiber is offset too far and it exceeds the X or Y motor range. 	<ul style="list-style-type: none"> •Press RESET key and re-position the fiber again to seat it correctly at the bottom of the V-groove.
Y Motor Overrun		
Focus X Motor Overrun	<ul style="list-style-type: none"> •The fiber is not set correctly at the bottom of the V-groove. The fiber position is out of focus range. 	<ul style="list-style-type: none"> •Press RESET key, and re-position the fiber again to seat it correctly at the bottom of the V-groove
Focus Y Motor Overrun	<ul style="list-style-type: none"> •Dust or dirt is on the fiber surface resulting in focus failure. •Dust or dirt is on the objective lens. 	<ul style="list-style-type: none"> •Completely prepare the fiber again (strip, clean and cleave). •Execute the [Dust Check]. Clean the lens.
Close Cover	<ul style="list-style-type: none"> •Unable to start splicing when the wind-protector opens. 	<ul style="list-style-type: none"> •The splicer automatically starts splicing after closing the wind-protector.
Cover Open	<ul style="list-style-type: none"> •The wind-protector is opened during splicing operation. 	<ul style="list-style-type: none"> •Press RESET key after closing the wind-protector.
ZL/R X/Y Focus X/Y Cover F/R Heater Motor trouble	<ul style="list-style-type: none"> •Motor might be damaged. 	<ul style="list-style-type: none"> •Consult the authorized distributor.

Cannot detect fiber in AUTO mode	·Dust or dirt is on the fiber surface.	·Completely prepare the fiber again (strip, clean and cleave). Select the suitable splice mode.
	·The left and right fiber types are different.	
	·Splicing non-standard fibers.	
Strong Arc Power	·Unable to calibrate due to strong arc.	·Replace the electrodes by using the [Replace Electrodes] function in. If this does not eliminate the problem, consult the authorized distributor.
Weak Arc Power	·Unable to calibrate due to weak arc.	
Too Left /Right Arc	·Unable to calibrate due to poor arc field position (too far left or Right).	
Fiber Separation	·The fiber stuff amount is insufficient.	·Execute the [Motor Calibration] function. If using other splice modes, check the [Overlap] setting in the splice mode.
	·The pre-fuse power or pre-fuse time is set too high.	·Check the [Prefuse Power] and [Prefuse Time] settings in the splice mode.
L/R-Bad Fiber Position	·The fiber is not set correctly at the bottom of the V-groove.	·Press RESET key, and re-position the fiber again to seat it correctly at the bottom of the V-groove.
No Arc Discharge	·Arc Discharge did not occur.	·Assure the electrodes are in proper position. ·Replace the electrodes. ·Consult the authorized distributor.

Error Message List

<i>Error Message</i>	<i>Reason</i>	<i>Solution</i>
<i>Large Cleave Angle</i>	<i>·Bad fiber end-face.</i>	<i>·Check the condition of the fiber cleaver. If the blade is worn, rotate the blade to a new position.</i>
	<i>·[Cleave Limit] is set too low.</i>	<i>·Increase the [Cleave Limit] to an adequate limit.</i>
<i>Large Fiber Angle</i>	<i>·Dust or dirt is on the V-groove or the clamp chip.</i>	<i>·Clean the V-groove and clamp chip, and set the fibers again. If the error occurs again, strip, clean and cleave the fibers.</i>
	<i>·Bad fiber end-face.</i>	<i>·Check the condition of fiber cleaver. If the blade is worn, rotate the blade to a new position.</i>
<i>Cleave Shape NG</i>	<i>·Bad fiber end-face.</i>	<i>·Check the condition of fiber cleaver. If the blade is worn, rotate the blade to a new position.</i>
<i>Arc Discharge Delayed</i>	<i>·Arc Discharge is delayed</i>	<i>·Assure the electrodes are in proper position. ·Execute the [Stabilize Electrode] function. ·Replace the electrodes.</i>
<i>Thin Fiber</i>	<i>·Inadequate arc power</i>	<i>·Calibrate the arc power with the [Arc Calibration] function.</i>
	<i>·Prefuse power or time is set too high</i>	<i>·If using the Other mode, adjust or initialize [Prefuse Power] or [Prefuse Time] settings. For normal splice mode, the prefuse is fixed and cannot be adjusted.</i>
	<i>·Insufficient [Overlap] setting</i>	<i>·If using the Other mode, adjust or initialize [Overlap] setting. For normal splice mode, the overlap is fixed and cannot be adjusted.</i>
<i>Fat Fiber</i>	<i>·Too much [Overlap] setting</i>	<i>·Execute [Motor Calibration] function in the maintenance menu to calibrate the stuff amount.</i>
<i>Too Tapering Fiber</i>	<i>·Too much fiber taper.</i>	<i>·If using the taper splice function, the error message may appear meaning the fiber is tapered too much.</i>
<i>Bubble</i>	<i>·Bad fiber end-face.</i>	<i>·Check the condition of fiber cleaver. When the blade is worn, rotate the blade.</i>
	<i>·Prefuse power or time is set too low</i>	<i>·If using the Other mode, adjust or initialize [Prefuse Power] or [Prefuse Time] settings. For normal splice mode, the prefuse is fixed and cannot be adjusted.</i>
<i>Large Dust Burn</i>	<i>·Bad fiber end-face.</i>	<i>·Check the condition of the fiber cleaver. If the blade is worn, rotate the blade to a new position.</i>
	<i>·[Cleaning Arc] time is too short or "OFF."</i>	<i>·Dust still present after cleaning fiber or cleaning arc. Clean fiber thoroughly or Increase [Cleaning Arc Time]</i>

Error Message List

Error Message	Reason	Solution
High Estimated Loss	·Insufficient fiber cleaning.	<ul style="list-style-type: none"> ·Dust or dirt on the fiber surface results in bad splice loss and low tensile strength. ·Clean the fiber surface sufficiently. ·Do not clean the fiber after cleaving to prevent dust on the fiber end-face. ·Avoid any contact with the fiber end-face.
	·Bad fiber end-face.	<ul style="list-style-type: none"> ·Check the condition of fiber cleaver. If the blade is worn, rotate the blade to a new position. ·Confirm the [Cleave Limit] setting. 2.0° or less is recommended.
	·Dust or dirt is on the V-groove or the clamp chip.	·Dust or dirt on the V-groove or clamp chip causes poor fiber movement during fiber stuffing. Clean them periodically.
	·Dust or dirt is on the lens	·Execute the [Dust Check]. If dust or dirt exists, clean the lenses.
	·Bad electrode condition.	·Replace the electrodes if they appear worn (rounded tip shape), dirty or bent.
	·Inadequate arc power.	·Calibrate the arc power with the [Arc Calibration] function.
	·Using unsuitable splice mode	·Select a suitable splice mode for the fibers to be spliced.
	·[Loss Limit] is set too low.	·Increase [Loss Limit] to an adequate limit.
	·Inadequate arc parameters in other splice modes	·Confirm the arc parameters are adequate to splice the fibers.
·Inadequate estimating parameters in Other mode	·Confirm the estimating parameters are adequate to estimate the loss. The MFD mismatch function does not work for certain types of specialty fibers. In these cases, set the [MFD Mismatch] to "OFF".	

Error Message List

<i>Error Message</i>	<i>Reason</i>	<i>Solution</i>
<i>There is dust after executing Dust Check function</i>	<i>·Dirt or dust exists in optical path.</i>	<i>·Clean the objective lenses by referring see section [Cleaning of Objective Lens]. ·When the above processes cannot remove the dirt or dust, consult the authorized distributor.</i>
<i>X Camera Y Camera Trouble</i>	<i>·The Camera may be damaged.</i>	<i>·Consult the authorized distributor.</i>
<i>Heater Oven Trouble</i>	<i>·Heater does not heat.</i>	<i>·Consult the authorized distributor.</i>
<i>Communication error</i>	<i>·Broken the internal device</i>	<i>·Consult the authorized distributor.</i>
<i>Temperature Sensor NG</i>	<i>·Temperature Sensor may be damaged.</i>	<i>·Consult the authorized distributor.</i>

Power Supply

- (1) Power does not turn on when pressing **ON/OFF** key
 - The battery may not be charged. Charge is performed.
- (2) Power does not turn off when pressing **ON/OFF** key
 - Press and hold the key until the LED color changes from green to red.
- (3) Few splices can be made with a fully charged battery pack
 - If the power saving function is not enabled, battery power degrades quicker. Always enable it to conserve power usage.
 - The battery pack has reached the end of its service life. Install a new battery pack.
 - The battery pack uses chemical reaction. The capacity decreases at low temperature, especially at lower than 0 degree C.
 - At high altitude, the arc discharge current is increased. In this condition, battery power degrades quicker due to large power consumption.
- (4) “CHARGE” LED on blinks during battery recharge
 - The battery pack has a fault or has reached the end of its service life. Install a new battery pack. If the LED blinks again after install, contact the authorized distributor.
 - The battery pack has been used under the environment (especially 40 degrees C or more) where temperature is high, or direct rays.
- (5) Method to change the power saving function settings
 - Refer to [Machine Settings] function.
- (6) Battery indicator is not displayed.
 - At the time of AC adaptor use, a battery indicator is not displayed on a screen.

Splicing Operation

- (1) Error message appears on monitor
 - Refer to [Error Message List] function.
- (2) Inconsistent splice loss / High splice loss
 - Clean the V-grooves, fiber clamps, wind-protector mirrors, and objective lenses.
 - Replace the electrodes.
 - “High Estimated Loss” error message section in the [Error Message List].
 - If the fiber has curl or bend memory, position the fiber so the crown (curve) of the memory is turned downward.
 - The splice loss varies according to the cleave angle, arc conditions and fiber cleanliness.
 - If the splice loss is still too high or inconsistent after performing the above-mentioned remedies, contact the authorized distributor. Regular service (at least once a year) is recommended to maintain high splicing quality.
- (3) Confirmation of splicing procedures
 - Refer to [Basic Operation] function.
- (4) Monitor suddenly turned off
 - The power saving function is automatically enabled when using a battery pack. The splicer switches to the power saving state after an extended period of splicer inactivity. Press any key to return to the normal state. To change the length of time before the splicer switches to the power saving state, Refer to [Machine Settings] function.
- (5) Splicer power suddenly turned off without “Low Battery” message
 - The power saving function is automatically enabled when using a battery pack. The splicer turns the splicer power off after an extended period of splicer inactivity. Press **ON/OFF** key to turn on the splicer again. To change the length of time before the splicer turns the splicer power off, section [Machine Settings] function.
- (6) Method to initialize arc condition of Splice mode
 - Refer to [Initialization in the edited parameter] in [Splice Menu].

- (7) Error message can be over-ridden
 - See Section [Splice Settings] to not allow error message override.
- (8) Unable to change Arc Power and Arc Time
 - The settings cannot be changed in AUTO modes.
 - If using the “Other Mode”, the Arc Power and Arc Time may be locked by administrator, preventing them from being changed.
- (9) Method to set Pause
 - See Section [Splice Menu] in [Splice Mode].
- (10) Method to display Cleave Angle, Fiber Angle / Offsets
 - See Section [Splice Menu]. The fiber angle is not displayable in the SM, DS, MM or AUTO mode.
- (11) Incorrect splice mode selected and used in AUTO mode
 - The AUTO mode can detect only standard SM, DS, MM and NZDS fibers. When splicing specialty fibers, the AUTO mode may identify them incorrectly.

Tube-heating Operation

- (1) Fiber protection sleeve does not shrink completely
 - Extend the heating time. Refer to [Heater Mode].
- (2) Heater LED on panel keyboard blinks
 - Pressing the **HEAT** key during heating causes the LED to blink. The tube heater is turned off if the **HEAT** key is pressed again. If, after 2 seconds have gone by without pressing the **HEAT** key again, the LED stays on continuously and the heater returns to its normal state. The LED will turn off when the heat cycle is completed.
 - If the heating temperature does not reach its inputted setting, the LED blinks and the alarm sounds. If this happens, contact the authorized distributor.
- (3) Fiber protection sleeve adhered to heating plate after shrink
 - Use a cotton swab or a similar soft tip object to push and remove the sleeve. If the black coating is removed, contact your authorized distributor.
- (4) Method to initialize heating condition of Heater mode
 - See Section [Referring to or editing Heater Mode].
- (5) Method to cancel heating process
 - RESET** key does not cancel the heater. Press **HEAT** key twice to cancel the heating process.

Supervising

- (1) What functions can be disabled
 - See Section [Menu Lock Settings].
- (2) Method to lock “selection” or “editing” of Splice or Heater mode
 - See Section [Menu Lock Settings].
- (3) Method to set parameters of Splice or Heater mode from a PC
 - Refer to the communication software “Data Connection” included in CD-ROM.
- (4) Forgot password
 - Contact the authorized distributor.

Other Functions

- (1) Method to hide messages on [READY] screen
 - Change the fiber image from X/Y view to X magnified view or Y magnified view by pressing  key.
- (2) Too many repetitions until “Test Finish” indicated in [Arc Calibration]
 - The splicer needs to repeat the arc calibration after replacing the electrodes or when the environmental conditions change drastically. The number of arc calibrations can be set to a specific amount. When the splicer completes the set amount of calibrations, it indicates “Test Finish”. However, this does not mean it is completely calibrated.
- (3) “Test Finish” is never indicated after many repetitions in [Arc Calibration]
 - Execute [Stabilize Electrodes] function in [Maintenance Menu]. If the splicer still does not indicate “Test Finish”, replace the electrodes. See section [Replace Electrodes] function.
- (4) No arc power change after [Arc Calibration]
 - An internal factor is calibrated and adjusted for the specific arc power selected. The displayed arc power in each splice mode does not change.
 - The calibration results affect all splice modes.
- (5) Method to input different comments after each splice in splice results data
 - See section [Splice Memory Comment].

Guarantee

1. Guarantee period and limits

If the splicer becomes out of order within one year from the date of delivery, we will repair it free of charge. However, note that repairs will be charged for the following cases regardless of the guarantee period:

- (1) *Trouble or damage due to natural disaster.*
- (2) *Trouble or damage due to mishandling.*
- (3) *Trouble or damage due to handling in disregard of the operating procedures or instructions described in the instruction manual.*
- (4) *Consumable items (discharge electrodes etc.)*
Please note that the memory of the splice results, parameters, etc. may be deleted during the repair.
- (5) *Trouble or damage due to abnormal voltage supply.*
Most cases of damage to the AC adapter from an abnormal power supply occur within the warranty period. The specification of AC input voltage is up to AC240V (340V-peak). For this reason, Fujikura Ltd. will provide a warranty replacement of the AC adapter only one time. In a second AC adapter is damaged during the warranty period, Fujikura Ltd. will not replace it free of charge.

2. Before shipping the splicer

Please consult the authorized distributor first.

3. Necessary information needed for repair

Include documentation with the splicer informing us of the details listed below.

- (1) *Your full name, section, division, company, address, phone number, fax number and e-mail address.*
- (2) *Model name and serial number of the splicer.*
- (3) *Problems encountered*
 - *What problems did your splicer get into and when?*
 - *What is its present operational state?*
 - *The state of the monitor and the contents of the relevant error message.**Etc.*

4. Transporting the splicer

Since the splicer is a high-precision machine, always use the original carrying case for transportation and storage in order to protect it against humidity, vibration and shock. When requesting splicer repair, please send it, along with its accessories, in its original carrying case.

5. Note for Repair

Please note the memory contents, such as splicing results, splice mode, etc., may be lost depending on the kind of repair.

Contact Address

Inquiries concerning products should be made to the authorized distributor or one of the following:

Fujikura Europe Ltd.

C51 Barwell Business Park
Leatherhead Road, Chessington, Surrey KT9 2NY
England
Tel. +44-20-8240-2000 (Service: +44-20-8240-2020)
Fax. +44-20-8240-2010 (Service: +44-20-8240-2029)
URL <http://www.fujikura.co.uk>

AFL Telecommunications

260 Parkway East
Duncan, SOUTH CAROLINA 29334
U.S.A.
Tel. +1-800-235-3423 (Service: +1-800-866-3602)
Fax. +1-864-433-5560 (Service: +1-800-433-5452)
P.O.Box 3127 Spartanburg, SC 29304-3127
URL <http://www.AFLglobal.com>

Fujikura Asia Ltd.

438A Alexandra Road, #08-03 Blk A Alexandra Techno Park,
SINGAPORE, 119967
Tel. +65-6-2711312 Fax. +65-6-2780965
URL <http://www.fujikura.com.sg>

Fujikura Ltd.

Optical Fiber & Equipment Department
International Sales & Marketing
1-5-1 Kiba, Koto-ku, Tokyo 135-8512
Japan
Tel. +81-3-5606-1164 Fax. +81-3-5606-1534
URL <http://www.fujikura.co.jp>

----- End of Document -----