



Vectron Systems

Leading in POS Technology

POS Vario

POS ColorTouch 64 Bit

POS Mini 64 Bit

User manual



Your Vectron dealer

Stamp

Date: 25.03.2011

© 2005 - 2011 by Vectron Systems AG

Subject to error and modification

Manufacturer

Vectron Systems AG

Willy-Brandt-Weg 41

48155 Muenster / Germany

www.vectron.de

Vectron
Leading in POS Technology

VECTRON POS HARDWARE

Contents

1. Introduction.....	9
2. Target group for this manual	10
3. Electromagnetic compatibility.....	11
4. Notes on safety.....	12
5. Instructions for use	13
6. Disposal	14
7. Vectron POS Vario	19
7.1. Shipment	19
7.2. The cash register and its components	20
7.3. Swiveling color display	21
7.4. Inserting the keyboard template.....	22
7.5. Using the touch screen.....	22
7.6. Accessories	23
7.6.1. Internal customer display	23
7.6.2. Stainless steel stand.....	24
7.7. Additional information	25
7.8. Technical data of Vectron POS Vario	25
8. Vectron POS ColorTouch	31
8.1. Shipment	31
8.2. The cash register and its components	32
8.3. Using the touch screen.....	34
8.4. Accessories	34
8.4.1. Internal customer display	35
8.4.2. Protective foil for the TFT touch display	36
8.4.3. Stainless steel stand.....	37
8.5. Additional information	38
8.6. Technical data Vectron POS ColorTouch.....	38

VECTRON POS HARDWARE

9. Vectron POS Mini	45
9.1. Shipment	45
9.2. The cash register and its components	46
9.3. Swiveling color display	47
9.4. Inserting the keyboard template.....	48
9.5. Using the touch screen.....	48
9.6. Accessories	49
9.6.1. Internal customer display	49
9.6.2. High-quality stainless steel stand.....	50
9.7. Additional information	51
9.8. Technical data of Vectron POS Mini.....	51
10. General hardware features	55
10.1. Ports	55
10.2. Lock systems	60
10.3. RAM extensions	61
10.4. Peripherals.....	61
11. Getting started	62
12. Operation	63
12.1. Sign in and out at the POS system.....	63
12.1.1. Sign in with key.....	64
12.1.2. Sign in without key.....	64
12.1.3. Sign out	64
12.2. Guest checks and hold buffers	64
12.2.1. Starting a new GC.....	65
12.2.2. Close and re-open a GC.....	65
12.2.3. Paying a guest check.....	65
12.2.4. Guest check split.....	66
12.2.5. Guest check move	66
12.2.6. Shift change.....	67
12.2.7. Hold buffers	67
12.3. Reports.....	67
12.4. Input and output.....	70
12.4.1. Input of amounts	70
12.4.2. Screen windows.....	70

12.5.	Making a sale	71
12.5.1.	Input of PLUs	71
12.5.2.	Free price input	71
12.5.3.	Payment	72
12.6.	Void and merchandise return	72
12.6.1.	Void LE.....	72
12.6.2.	Void.....	73
12.6.3.	Merchandise return	73
12.7.	Change invoice format.....	73
12.8.	Access rights.....	73
12.9.	Final remark.....	74
13.	Service and maintenance	75
13.1.	Cleaning the cabinet.....	75
13.2.	Cleaning the display.....	75
13.3.	Screen saver	76
14.	Additional Vectron products.....	77
14.1.	Vectron POS Modular	77
14.2.	Vectron POS MobilePro	77
14.3.	Vectron POS PC.....	79
14.4.	Vectron Commander	79
15.	EU declaration of conformity.....	80
Supplement	81
	Important notes for the connection of scales	81
	Piktographs	82
	Glossary	85
	Document revision.....	87

1. Introduction

We very much appreciate your purchase of a Vectron POS system. You have decided in favor of a high quality product that will support you in your daily work.

This manual contains information on the following stationary Vectron POS systems with 64 Bit hardware:

- Vectron POS Vario (see chapter 7)
- Vectron POS ColorTouch (see chapter 8)
- Vectron POS Mini (see chapter 9)

In these chapters the Vectron POS systems are described individually.

In chapter 10 you then get an overview on hardware features and equipment options that all systems have in common.

For information on how to start and to operate the Vectron POS System see chapters 11 & 12.

Please see the supplement for the notes on connection of scales.

Finally, we draw up a glossary.

Please follow the instructions for use and notes on safety on the following pages.

Vectron Systems AG

2. Target group for this manual

This manual is meant for all users of the Vectron POS systems POS Vario, Vectron POS ColorTouch and Vectron POS Mini and describes all basic procedures for operating these systems.



Note

This manual does not contain information concerning the extensive programming of the Vectron POS system. This requires detailed specialist knowledge and therefore lies in the responsibility of your trained Vectron dealer. Please address all further questions to your Vectron dealer. He will be glad to assist you.

3. Electromagnetic compatibility

- These are Class A products. In a domestic environment these products may cause radio interference in which case the user may be required to take adequate measures.
- The electromagnetic emissions of the devices are below the standardized limit values for interferences. However we cannot guarantee a complete protection against disturbance of radio and TV reception, if the devices are applied in business- and living areas in a distance of less than 33 ft from the receiving aerial.
- Installation and maintenance should be carried out by EMC-skilled personnel.
- Special hints concerning the cabling
 - USB-, PS/2-, parallel and drawer cables may not exceed 10 ft. This restriction does not apply to RS232- and network cables.
 - You should always use shielded cables. Unshielded cables must have a ferrite core mounted as close to the Vectron POS unit as possible.

4. Notes on safety

When operating your Vectron POS system please follow these instructions:

- Only by means of proper positioning and maintenance, as well as proprietary operation according to the reference instructions, the safety and health of individuals and of animals and property, will not be endangered.
- Improper installation, maintenance, or operation may result in injury to the user and damage to the devices.
- Maintenance and repair of the Vectron POS system is to be carried out only by trained personnel, certified by the manufacturer.
- The Vectron POS system has been manufactured to the highest possible standards. However, we cannot guarantee that the delivered components, their constituent parts and the documentation are, and will remain, free of faults.
- The manufacturer does not accept liability in case of improper installation and maintenance and improper operation of the Vectron POS system.

5. Instructions for use

Please follow these instructions:

- Only operate the POS system with the dealer installed peripherals.
- Do not insert any foreign objects into any openings on the devices.
- The power supply Vectron PS10 must be plugged into a properly grounded outlet.
- The POS system may not be exposed to direct sunlight. Ensure there is sufficient airflow around the device to allow for adequate cooling.
- Protect the POS system from dust and humidity.
- Protect the POS system from improper voltages.
- Clean only with a damp cloth using a mild cleanser.
- Before opening the housing of the Vectron POS system, unplug it from the outlet.
- In case of service please contact your Vectron dealer. When sending the device for repair always use the original packing. For damages due to improper packing the manufacturer does not accept liability.

6. Disposal

The manufacturer assumes a unilateral obligation to take back waste electric and electronic equipment that has been used for commercial purposes, consistent with Art. 9 of European Union Directive 2002/96/EC, last changed by European Union Directive 2003/108/EC. It applies:

- The manufacturer takes back waste electric and electronic equipment that was produced by or on behalf of the company and guarantees a proper recycling of this equipment.
- The legal obligation applies for devices, that will be put on the market after August 13, 2005. In addition, the manufacturer extends this obligation to all devices that have been put on the market as of January 1, 2004.
- Please hand over any waste electric or electronic equipment and any accessories or peripherals that you do not require or that cannot be used anymore to your Vectron dealer. Or send it back to the manufacturer directly, prepaid and marked „Waste electric and electronic equipment“.



WEEE-Reg.-No. DE 91733199

VECTRON POS VARIO

Contents

7. Vectron POS Vario	19
7.1. Shipment	19
7.2. The cash register and its components	20
7.3. Swiveling color display	21
7.4. Inserting the keyboard template.....	22
7.5. Using the touch screen.....	22
7.6. Accessories	23
7.6.1. Internal customer display	23
7.6.2. Stainless steel stand.....	24
7.7. Additional information	25
7.8. Technical data of Vectron POS Vario	25

VECTRON POS VARIO

7. Vectron POS Vario

In this chapter you get numerous technical information on the Vectron POS Vario. You are also informed on accessories available for this POS system. For additional hardware features and equipment options please see chapter 10.

The Vectron POS Vario distinguishes itself by a number of technical features and functions. The 64-bit-technology and the battery buffered RAM accelerate data access, guarantee fast processing and avoid data loss in case of a power failure. In addition, the Vectron POS Vario has a small, compact housing, which only requires a small footprint.

7.1. Shipment

Standard delivery of the Vectron POS Vario comprises:

- One Vectron POS Vario, equipment according to order
- External power supply Vectron PS10
- National mains plug
- Four rubber feet
- Operator lock according to order
- User manual
- Dispatch box
- Software license according to order

Note:

The Vectron POS Vario is available with different equipment. Please check the correct delivery on receipt. In case of incorrect delivery please contact your Vectron dealer.

Your dealer will supply the system and install it. You may then start working immediately.

7.2. The cash register and its components

The Vectron POS Vario is available in different designs. They all have in common:

- Anthracite plastic housing, splash-proof
- Manually and steplessly adjustable TFT color display with a resolution of 640 x 480 pixels, 10.4 inch screen diagonal and a maximum of 256 colors
- Numerous ports at the bottom (see chapter 10.1)

Optionally available is the following equipment:

- Touch screen
- Integrated customer display, for the display of two lines, each with 20 alphanumeric characters

Finally, the Vectron POS Vario is alternatively available with flat keyboard (easy to label) or with raised keyboard.



Fig. 1: Vectron POS Vario with raised keyboard



Fig. 2: Vectron POS Vario with flat keyboard

7.3. Swiveling color display

The swiveling color display of the Vectron POS Vario allows an easy reading of the information. Being steplessly adjustable, the display's viewing angle can easily be adapted to the individual requirements of every user.

At the display's joint you can adjust individually the power you need to swivel the display. Please contact your Vectron dealer.

7.4. Inserting the keyboard template

The Vectron POS Vario without touch screen is exclusively operated via the keyboard. The individual keyboard elements can be assigned individual functions. This facilitates data input since you can book a PLU by simply pressing a button. For a better overview on the assigned functions, you can use a keyboard template.

For models with a flat keyboard, lift the cover foil at the front of the POS system and put the template under the foil.

For models with a raised keyboard, the function tags for each key have to be cut out. Put the function tag onto the key, then put on the plastic cover. Make sure that the cover is correctly adjusted. The tapered edge points at the operator.

7.5. Using the touch screen

If your POS system is equipped with a so-called touch screen you can operate the touch-sensitive display by using your finger. The monitor layout can be designed according to your demands. For the respective functions, elements can be created in this layout that considerably ease the input of data, as it sometimes suffices to actuate a touch button, e.g. to book to a PLU.



Attention!

The touch screen may only be touched with fingers.

The use of pens, pencils or other sharp objects may damage the device.

No liability is accepted for such damages!

7.6. Accessories

The Vectron POS Vario can be varied manifold. Thus, numerous accessories are available for this POS system:

- Internal customer display
- Stainless steel stand
- Lock systems (see chapter 10.2)
- SRAM extensions (see chapter 10.3)

7.6.1. Internal customer display

The Vectron POS Vario can be equipped or retrofitted with a customer display, which is integrated in the housing.



Fig. 3: Integrated customer display for Vectron POS Vario

7.6.2. Stainless steel stand

The high-quality stand made of stainless steel is ergonomically designed and very stable. Being steplessly adjustable, the viewing angle can be adapted individually to every user of the POS system.



Fig. 4: Table version of the stainless steel stand for Vectron POS Vario

7.7. Additional information

In chapter 10 you find additional information concerning hardware features and equipment options for the Vectron POS Vario.

In chapters 11 & 12 you are informed on how to start and to operate the Vectron POS Vario.

7.8. Technical data of Vectron POS Vario

Software

- 100,000 PLUS*
- 65,535 departments*
- 1,000 operators*
- 65,535 guest checks or customers*
- 200 cash registers per network*
- 100 printers per network*

*) The indicated values are maximum values, which can only be reached with special programming and optimum hardware equipment. Please contact your Vectron dealer to assist you with your special requirements.

Hardware

- 10,4" TFT Colordisplay with 640 x 480 pixels, max. 256 colors
- optional touch screen
- optional customer display
- flat or raised keyboard with 108 configurable keys

VECTRON POS VARIO

- 2 MB RAM (battery-buffered), upgrade to 4, 6 or 10 MB available
- 8 MB Flash memory for system software
- 10/100BaseT Ethernet connection for network operation
- six serial ports for printer, scanner, EFT Terminal, beverage control system, etc.
- parallel port
- two USB ports (Host & Function)
- two ports for up to four cash drawers (per adapter) with „Open Sensor“
- one PS/2 port for PC-keyboard and PC-mouse
- standard lock 'Dallas iButton', available in magnetic design, optional with lock systems 'EasyReader' or 'Adimat'
- 0 ... 40°C operation temperature
- -10 ... +50°C storage temperature
- Certificates: CE, UL listed

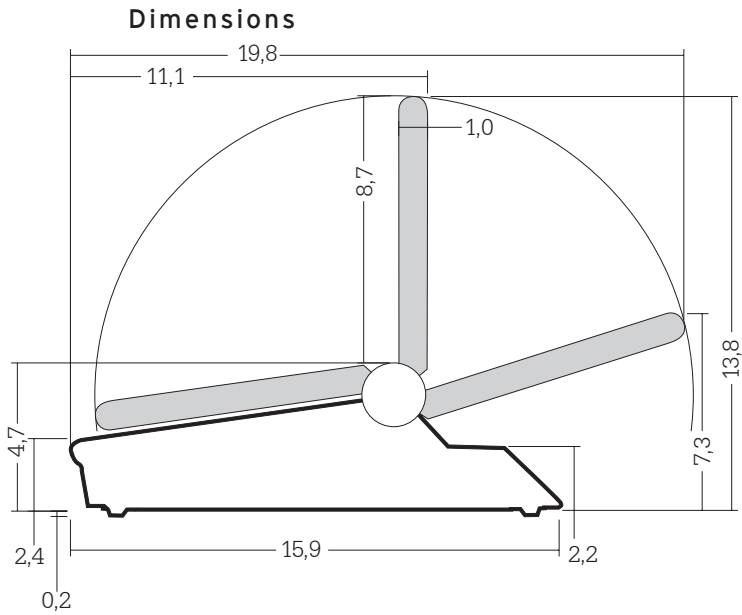

Dimensions above without rubber feet

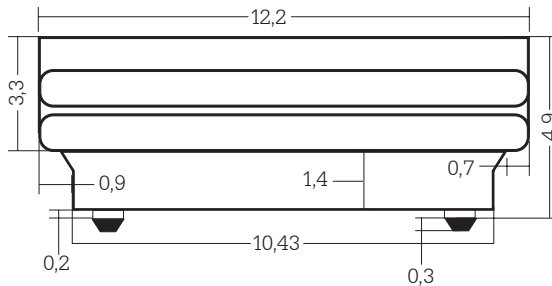

Dimensions above are indicated in inch. Metric dimensions are to be found in the respective German chapter.

Weight

approx. 4.200 g resp. 9.26 lb (incl. customer display)

Contents

8. Vectron POS ColorTouch	31
8.1. Shipment	31
8.2. The cash register and its components	32
8.3. Using the touch screen	34
8.4. Accessories	34
8.4.1. Internal customer display	35
8.4.2. Protective foil for the TFT touch display	36
8.4.3. Stainless steel stand.....	37
8.5. Additional information	38
8.6. Technical data Vectron POS ColorTouch.....	38

8. Vectron POS ColorTouch

In this chapter you get numerous technical information on the Vectron POS ColorTouch. You are also informed on accessories available for this POS system. For additional hardware features and equipment options please see chapter 10.

The Vectron POS ColorTouch distinguishes itself by a number of technical features and functions. The 64-bit-technology and the battery buffered RAM accelerate data access, guarantee fast processing, and avoid data loss in case of a power failure. In addition, the Vectron POS ColorTouch has a small, compact housing, which only requires a small footprint.

8.1. Shipment

Standard delivery of the Vectron POS ColorTouch comprises:

- One Vectron POS ColorTouch, equipment according to order
- External power supply Vectron PS10
- National mains plug
- Operator lock according to order
- Three supports in different sizes
- User manual
- Dispatch box
- Software license according to order

Note:

The Vectron POS ColorTouch is available with different equipment. Please check the correct delivery on receipt. In case of incorrect delivery please contact your Vectron dealer.

Your dealer will supply the system and install it. You may then start working immediately.

8.2. The cash register and its components

The Vectron POS ColorTouch is available in different designs. They all have in common:

- High-quality design with covering caps and type label made of stainless steel
Please note: When applying the „EasyReader3“ lock system (see chapter 10.2) one black plastic cap is used for technical reasons
- Splash-proof housing
- TFT color display with a resolution of 800 x 600 pixels, 12.1 inch screen diagonal and 256 colors
- Touch screen
- Numerous ports at the bottom (see chapter 10.1)

Optionally available is the following equipment:

- Alternative housing colors, anthracite or light gray
- Integrated customer display, for the display of two lines, each with 20 alphanumeric characters



Fig. 5: Vectron POS ColorTouch in anthracite design



Fig. 6: Vectron POS ColorTouch in light gray design

8.3. Using the touch screen

Your POS system is equipped with a so-called touch screen so you can operate the touch-sensitive display by using your finger. The monitor layout can be designed according to your demands. For the respective functions, elements can be created in this layout that considerably ease the input of data, as it sometimes suffices to actuate a touch button, e.g. in order to book a PLU.



Attention!

The touch screen may only be touched with fingers.

The use of pens, pencils or other sharp objects may damage the device.

No liability is accepted for such damages!

8.4. Accessories

The Vectron POS ColorTouch can be varied manifold. Thus, numerous accessories are available for this cash register system:

- Integrated customer display
- Protective foil for the TFT touch display
- High quality stainless steel stand
- Lock systems (see chapter 10.2)
- SRAM extensions (see chapter 10.3)

8.4.1. Internal customer display

The Vectron POS ColorTouch can be equipped or retro-fitted with a customer display, which is integrated in the housing.



ColorTouch
US

Fig. 7: Vectron POS ColorTouch with integrated customer display

8.4.2. Protective foil for the TFT touch display

A protective foil is available for the Vectron POS Color-Touch, that protects the screen from general contamination and moisture. Furthermore, this foil allows the user to operate the ECR under moist (e.g. bar) or partially impure (e.g. bakery) conditions.



Fig. 8: Vectron POS ColorTouch with protective foil

8.4.3. Stainless steel stand

The high-quality stand made of stainless steel is ergonomically designed and very stable. Being steplessly adjustable, the viewing angle can be adapted individually to every user of the POS system.



ColorTouch
US

Fig. 9: Vectron POS ColorTouch with stainless steel stand

8.5. Additional information

In chapter 10 you find additional information concerning hardware features and equipment options for the Vectron POS ColorTouch.

In chapters 11 & 12 you are informed on how to start and to operate the Vectron POS ColorTouch.

8.6. Technical data Vectron POS ColorTouch

Software

- 100,000 PLUs*
- 65,535 departments*
- 1,000 operators*
- 65,535 guest checks or customers*
- 200 cash registers per network*
- 100 printers per network*

*) The indicated values are maximum values, which can only be reached with special programming and optimum hardware equipment. Please contact your Vectron dealer to assist you with your special requirements.

Hardware

- 12.1" color TFT display with 800 x 600 pixels, 256 colors
- integrated customer display optional, connection for external customer display
- touch screen technology

- housing in light or dark available
- 2 MB RAM (battery-buffered), upgrade to 4, 6 or 10 MB available
- 8 MB Flash memory for system software
- 10/100BaseT Ethernet connection for network operation
- six serial ports for printer, scanner, EFT Terminal, beverage control system, etc.
- parallel port
- two USB ports (Host & Function)
- two ports for up to four cash drawers (per adapter) with „Open Sensor“
- one PS/2 port for PC-keyboard and PC-mouse
- standard lock 'Dallas iButton', available in magnetic design, optional with lock systems 'EasyReader' or 'Ad-dimat'
- 0 ... 40°C operation temperature
- -10 ... +50°C storage temperature
- Certificates: CE, UL listed

VECTRON POS COLORTOUCH

Dimensions

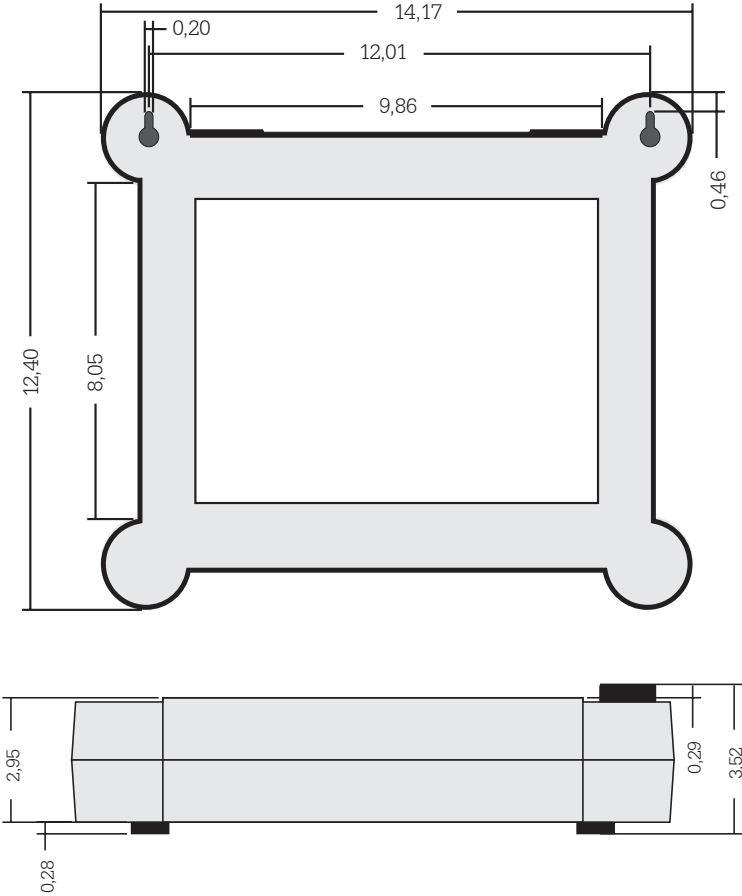

Dimensions above are indicated in inch. Metric dimensions are to be found in the respective German chapter.

Weight

approx. 4.000 g resp. 8.82 lb (incl. customer display)



VECTRON POS MINI

Contents

9. Vectron POS Mini	45
9.1. Shipment	45
9.2. The cash register and its components	46
9.3. Swiveling color display	47
9.4. Inserting the keyboard template.....	48
9.5. Using the touch screen.....	48
9.6. Accessories	49
9.6.1. Internal customer display	49
9.6.2. High-quality stainless steel stand.....	50
9.7. Additional information	51
9.8. Technical data of Vectron POS Mini.....	51

9. Vectron POS Mini

In this chapter you get numerous technical information on the Vectron POS Mini. You are also informed on accessories available for this POS system. For additional hardware features and equipment options please see chapter 10.

The Vectron POS Mini distinguishes itself by a number of technical features and functions. The 64-bit-technology and the battery buffered RAM accelerate data access, guarantee fast processing, and avoid data loss in case of a power failure. In addition, the Vectron POS Mini has a small, compact housing, which only requires a small footprint.

9.1. Shipment

Standard delivery of the Vectron POS Mini comprises:

- One Vectron POS Mini, equipment according to order
- External power supply Vectron PS10
- National mains plug
- Operator lock according to order
- User manual
- Dispatch box
- Software license according to order

Note:

The Vectron POS Mini is available with different equipment. Please check the correct delivery on receipt. In case of incorrect delivery please contact your Vectron dealer.

Your Vectron dealer will supply the systems and install it. You may then start working immediately.

9.2. The cash register and its components

The Vectron POS Mini is available in different designs. They all have in common:

- High-quality design with covering caps and type label made of stainless steel
- Manually and steplessly adjustable color display (CSTN) with a resolution of 320 x 240 pixels ($\frac{1}{4}$ VGA), 5.7 inch screen diagonal and 16 colors
- Flat keyboard, easy to label
- Numerous ports at the bottom (see chapter 10.1)

Optionally available is the following equipment:

- Alternative housing colors, anthracite or light gray
- Touch screen
- Integrated customer display, for the display of two lines, each with 20 alphanumeric characters



Fig. 10: Vectron POS Mini in anthracite design



Fig. 11: Vectron POS Mini in light gray design

9.3. Swiveling color display

The swiveling color display of the Vectron POS Mini allows an easy reading of the information. Being steplessly adjustable, the display's viewing angle can easily be adapted to the individual requirements of every user.

9.4. Inserting the keyboard template

The Vectron POS Mini without touch screen is exclusively operated via the keyboard. The individual keyboard elements can be assigned individual functions. This facilitates data input since you can book a PLU by simply pressing a button.

For a better overview on the assigned functions, you can use a keyboard template. For placing the template below the foil, lift the plastic cover foil at the front of the cash register and put the template under the foil.

9.5. Using the touch screen

If your POS system is equipped with a so-called touch screen you can operate the touch-sensitive display by using your finger. The monitor layout can be designed according to your demands. For the respective functions, elements can be created in this layout that considerably ease the input of data, as it sometimes suffices to actuate a touch button, e.g. to book to a PLU.



Attention!

The touch screen may only be touched with fingers.

The use of pens, pencils or other sharp objects may damage the device.

9.6. Accessories

The Vectron POS Mini can be varied manifold. Thus, numerous accessories are available for this cash register system:

- Integrated customer display
- Stainless steel stand
- Lock systems (see chapter 10.2)
- SRAM extensions (see chapter 10.3)

9.6.1. Internal customer display

The Vectron POS ColorTouch can be equipped or retro-fitted with a customer display, which is integrated in the housing.



Fig. 12: Vectron POS Mini with integrated customer display

9.6.2. High-quality stainless steel stand

The high-quality stand made of stainless steel is ergonomically designed and very stable. Being steplessly adjustable, the viewing angle can be adapted individually to every user of the POS system.



Fig. 13: Vectron POS Mini with stainless steel stand

9.7. Additional information

In chapter 10 you find additional information concerning hardware features and equipment options for the Vectron POS Mini.

In chapters 11 & 12 you are informed on how to start and to operate the Vectron POS Mini.

9.8. Technical data of Vectron POS Mini

Software

- 100,000 PLUS*
- 65,535 departments*
- 1,000 operators*
- 65,535 guest checks or customers*
- 200 cash registers per network*
- 100 printers per network*

*) The indicated values are maximum values, which can only be reached with special programming and optimum hardware equipment. Please contact your Vectron dealer to assist you with your special requirements.

Hardware

- 5,7" color display (CSTN), 320 x 240 pixels ($\frac{1}{4}$ VGA), 16 colors
- optional touch screen
- optional customer display
- flat keyboard with 108 configurable keys

VECTRON POS MINI

- Housing in light and dark available
- 2 MB RAM (battery-buffered), upgrade to 4, 6 or 10 MB available
- 8 MB Flash memory for system software
- 10/100BaseT Ethernet connection for network operation
- standard is one serial port for printer, scanner, chipcard terminal, beverage control systems etc.
extension to six ports per software release
- optional parallel printer port (software release)
- two USB ports (Host & Function)
- two ports for up to four cash drawers (per adapter) with „Open Sensor“
- one PS/2 port for PC-keyboard and PC-mouse
- standard lock 'Dallas iButton', available in magnetic design, optional with lock systems 'EasyReader' or 'Ad-dimat'
- 0 ... 40°C operation temperature
- -10 ... +50°C storage temperature
- Certificates: CE, UL listed

Dimensions

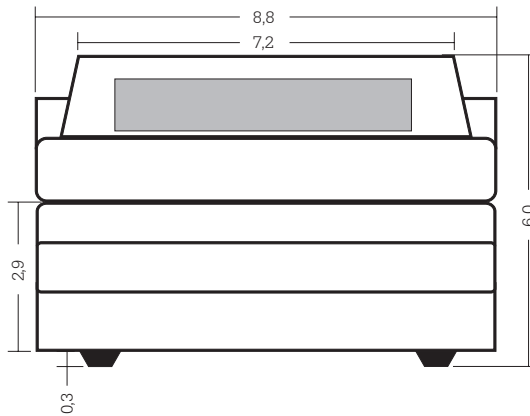
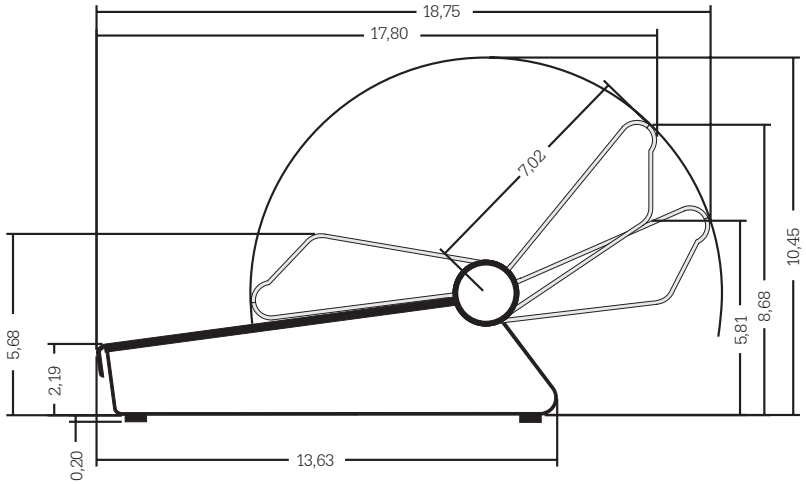

Dimensions above are indicated in inch. Metric dimensions are to be found in the respective German chapter.

Weight

approx. 3.120 g resp. 6.88 lb (incl. customer display)

10. General hardware features

In this chapter you get additional technical information that applies for all stationary Vectron POS systems with 64 Bit technology.

10.1. Ports

At the bottom of the Vectron POS system there are numerous ports via which external devices can be connected to the POS system (see fig. 14).

- Six serial ports (RS232) for the connection of e.g. customer displays, scanners, magnetic card readers, printers, operator locks, modems etc.
One of these ports allows to connect the Vectron POS System to a PC. With this connection for instance a software-update of the POS system can be made. Entries can be read out and processed.
- Two USB ports for updates and backup on USB sticks
- One PS/2 port for the connection of PC-keyboard and mouse (single or parallel per adapter).
- One network port (10/100 MBit) to establish an extensive network with up to 200 Vectron POS systems.
- Two ports for cash drawers. Per adapter a whole of four cash drawers (two per port) can be connected and addressed.
- One parallel port (Centronics) for the connection of e.g. one A4-paper printer.
- One power supply for the Vectron POS system via external power pack Vectron PS10.

All ports are mounted on-board of the Vectron POS system.

VECTRON POS HARDWARE

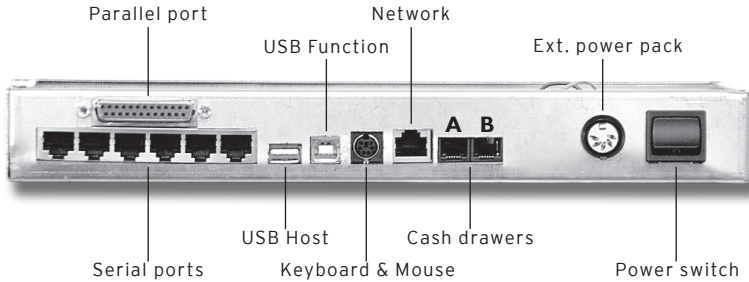

Fig. 14: Ports of the Vectron POS system

Note for Vectron POS Vario and Vectron POS Color-Touch:

The basic license releases all ports.

Note for Vectron POS Mini:

The basic license of the Vectron POS Mini clears one of the six serial ports. In order to use additional serial and parallel ports, release via an additional license is required.

Serial ports

	PIN	Assignment
	1	DSR (in)
	2	RxD (in)
	3	+ 5 V (max. 500 mA)
	4	TxD (out)
	5	n/c
	6	DTR (out)
	7	+ 24 V (max. 100 mA)*
	8	GND

*) This voltage must be activated manually. Please contact your Vectron dealer.

Parallel port

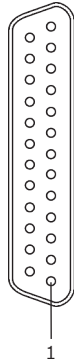

PIN	Assignment	PIN	Assignment
1	/Strobe	14	Auto Feed
2	Data0	15	Error
3	Data1	16	/ Init
4	Data2	17	Select In
5	Data3	18	GND
6	Data4	19	GND
7	Data5	20	GND
8	Data6	21	GND
9	Data7	22	GND
10	/Acknlg	23	GND
11	/Busy	24	GND
12	PE	25	GND
13	Select		

USB ports

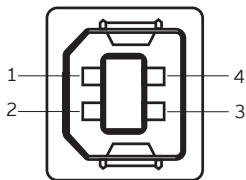

USB Function

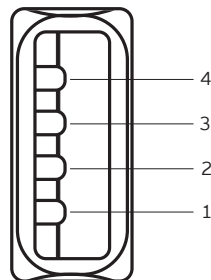

USB Host

PIN	Assignment
1	VBUS
2	D-
3	D+
4	GND

VECTRON POS HARDWARE

PS/2 ports (PC keyboard and mouse)

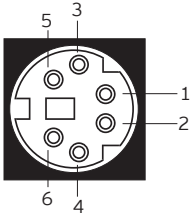

PIN	Assignment
1	KeyData
2	MouseData
3	GND
4	5V
5	KeyClock
6	MouseClock

10/100BaseT network port

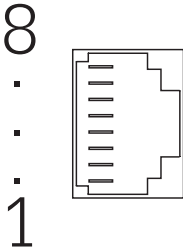

PIN	Assignment
1	TD+
2	TD-
3	RD+
4	n/c
5	n/c
6	RD-
7	n/c
8	n/c

Ports for cash drawer



PIN	Assignment A	Assignment B
1	GND	GND
2	Drawer 1	Drawer 2
3	Open Sensor	Open Sensor
4	+ 24 V	+ 24 V
5	Drawer 3	Drawer 4
6	+ 24 V	+ 24 V

External power pack

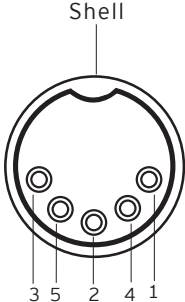
	PIN	Vectron POS Vario	Vectron POS ColorTouch	Vectron POS Mini
	1	GND		
	2	GND		
	3	5V / 4A	5V / 3A	5V / 3A
	4	GND		
	5	24V / 0.6A	24V / 1A	24V / 0.6A
	Shell	Frame GND		



Attention!

Please note:

Please use exclusively the supplied power supply Vectron PS10 for the power supply of your Vectron POS system.

Other power supplies may damage or destroy the POS system.

No liability is accepted for such damages!

VECTRON POS HARDWARE

10.2. Lock systems

Your Vectron POS system can be combined with various lock systems. Overview:

Lock	Figure	Key	Features
Dallas iButton Standard		 52 x 20 x 8 mm, 5 g	<ul style="list-style-type: none"> • easy handling • key available with memory • available in different colors
Dallas iButton Magnet		 54 x 21 x 8 mm, 9 g	<ul style="list-style-type: none"> • easy handling • magnetic • key available with memory • operator sign-out by key removal • available in different colors
Addimat		 56 x 10 mm, 6 g	<ul style="list-style-type: none"> • robust and long-lived • magnetic • operator sign-out by key removal
Easy Reader		 78 x 20 mm, 17 g	<ul style="list-style-type: none"> • transponder technology allows contact-less functioning • extremely robust • magnetic • particularly suitable for numerous customer contacts with frequent operator sign in and sign out • available in different colors • also available as Easy-Watch and EasyRing

For additional information on these lock systems and their application please contact your Vectron dealer.

10.3. RAM extensions

Standard RAM equipment of the Vectron POS system is two megabyte of main memory. In order to upgrade the data memory, three memory extensions are available: 2MB, 4MB and 8MB.

The data memory stores all customer-specific data. With a memory extension, a considerable higher number of bookings can be processed.

Please ask your Vectron dealer whether a memory extension will be useful for you.

10.4. Peripherals

The numerous ports of the Vectron POS systems have already been described (see chapter 10.1). They allow the connection of numerous peripherals. These are external customer displays, printers, magnetic card readers, scanners, operator locks, modems etc.

Please contact your Vectron dealer if you want to connect peripherals to your Vectron POS system. He will provide you with detailed information on peripherals and will assist you with installation and configuration.

11. Getting started

Place the cash register on a stable and even surface. The set-up area must guarantee that the cash register is protected from bad influences such as high or low temperatures, high air humidity or splash. Please refer to the technical data for all relevant data concerning the set-up area.

The power connection of the Vectron POS system is at the bottom. First connect the external power pack Vectron PS10. Then connect the external power pack with the power supply network.



Attention!

Please note:

Please use exclusively the delivered Vectron PS10 for the power supply of your Vectron POS system.

Other power supplies may damage or destroy the POS system.

No liability is accepted for such damages!

The mains switch of the Vectron POS system is also at the bottom. Use the switch to start the POS system.

The display is now illuminated and the POS system carries out a self test where various values are indicated, e.g. hardware version, software version, series number and available memory.

12. Operation

This chapter gives an overview on the functions of your Vectron POS system and an introduction into the basic operating procedures. Your Vectron dealer has programmed your POS system to meet your operating requirements. Some of your operating procedures may therefore differ from those described in this manual. Your Vectron dealer will fully explain the functions installed for you.



Notes

- The following operating instructions of the POS system use the term „key“. The Vectron POS ColorTouch, POS Vario and POS Mini with touch screen allow the application of the touch screen. „Key“ therefore refers to the corresponding buttons of the touch screen
- As of version 4.0 of the Vectron POS software the buttons on the touch screen display their functions mainly by small pictographs, so-called icons. The icons contained in the Vectron POS software and their meaning are explained in the supplement.

12.1. Sign in and out at the POS system

The operator must sign in to the Vectron POS system in order to enter PLUs or hold-buffers. Thus you can verify at any time which operator has made which entries. Different users can be vested with different authorizations, e.g. void.

There are various possibilities to sign in or out at the Vectron POS system.

12.1.1. Sign in with key

You sign in to the Vectron POS system by holding the key to the lock. If an additional secret number has been programmed, enter this number and confirm with <Enter>.

12.1.2. Sign in without key

Sign in without key is possible in case you have been assigned a operator number and the sign in by key is not compulsory. Enter this operator number and press the <Operator> key or . If required, enter your secret number and confirm with <Enter>.

12.1.3. Sign out

For sign out there are also various possibilities:

- by removal of the key
- by holding the key to the lock again
- by closing the receipt
- by pressing the <Operator> key or 

12.2. Guest checks and hold buffers

Guest checks and hold buffers serve to store several invoices simultaneously. This function is often required in restaurants, to store the goods consumed for each guest check.

In retail, it can also be useful to store several invoices simultaneously, if for instance in a bakery there is only one cash register for several operators. In a supermarket, if a customer forgot his wallet in his car, the entire sale can be stored temporarily in a “hold-buffer” so that other custo-

mers can be serviced until the customer returns with his wallet.

12.2.1. Starting a new GC



To open a new guest check, enter the number and depress the <GC> key or .

12.2.2. Close and re-open a GC

By pressing the <GC> key or , the guest check is closed. Depending on the programming, the order is now printed on different printers, e.g. at the counter or in the kitchen. The POS system is now open for other orders.

If you want to re-open a GC to make further entries, repeat the steps (see above).



12.2.3. Paying a guest check

To finalize a GC, open it again (see above). The balance is displayed. If you now press <Cash> or  or any other media key, the invoice is printed and all PLUs are deleted from the GC. Before pressing the <Cash> key or  you can enter the amount you got from the customer and the change is displayed.



Depending on the programming of your POS system, there are several other possibilities. For instance you can first print a subtotal invoice and then print the total invoice after the guest decided on the mode of payment.

12.2.4. Guest check split

It may often be necessary to split the guest check, if for instance one guest wants to leave earlier than the others. For these cases you have the function "G.C. Split". This function is only available for operators who have been vested with the according authorization.



To split a G.C., it must be opened again. If necessary close the GC and open it again. Press the <GC split> key or . Select the PLUs to be split via the direct PLU keys or via PLU numbers. Having selected all PLUs close with <Cash> or  or another media key. The invoice is printed.

It may also happen that a guest changes the table. You can then split PLUs from one GC to another.

Proceed as described above but before pressing the key <GC split> or  enter the number of the GC to which the PLUs are to be transferred. Close with <GC> key or .

12.2.5. Guest check move

Rather than splitting single PLUs from one check to another, "Check Move" allows the entire check to be moved to another guest check. The operators must be vested with the according authorization.

- Open the G.C. to be moved. If the G.C. has already been opened, close it with <G.C.> or  and open it again via GC no. and <GC> key or . G.C. moves can only be carried out if the G.C. is opened anew.
- Enter the target guest check number and close with <GC move> key or . The guest check that has been moved is automatically closed.

12.2.6. Shift change

Shift change means that a guest check is transferred to another operator (e.g. change of shift). Open the guest check that is to be transferred. Enter the number of the operator to whom the guest check is to be transferred and press <Shift change> or .

12.2.7. Hold buffers

To open a hold buffer press the respective key. By means of the hold buffer keys you can switch between the individual hold buffers. To close a hold buffer press a media key.

Depending on the programming of the POS system a hold buffer is automatically assigned to a certain operator. In this case the hold buffer change is automatically carried out if a new operator signs in.

12.3. Reports

The Vectron POS System offers numerous possibilities to combine the bookings of a certain period or clerk in a report. You can select all reports via the <Mode> key or <M> or via special keys and print them afterwards.

It is also possible to read reports by means of the PC program Vectron Commander and to process them on the computer.



Note

It depends on the programming and on the operators' authorization which reports can be called. Please contact your Vectron dealer.

VECTRON POS HARDWARE

When pressing the <Mode> or <M> key you can select between „X-reports“ and „Z-reports“.

“X-reports” are interim reports, the memory is not deleted. All data is kept for further reading and processing.

“Z-reports” are final reports, the memory is reset to zero and the report cannot be restored!

After choosing either an X-report or a Z-report, you may decide which report is to be printed. The following are short descriptions of some of the most common reports.

Cashiers

An overview of the financial data for each operator.

Cashier (single)

An overview of the financial data for only one operator.

Cashier invoices

Shows the invoices that were created by each operator in the reporting period.

- An **X-report** creates a subtotal invoice with the guest check still open for service
- A **Z-report** creates a final invoice and closes the guest check

Open GCs

Lists all guest checks that have not yet been paid.

Invoices

Shows all invoices that were created in the reporting period.

- An **X-report** creates a subtotal invoice with the guest check still open for service
- A **Z-report** creates a final invoice and closes the guest check

Hourly report

Indicates the turnover per hour.

Transactions

Gives an overview of the financial data, including turnover, taxes and cash in drawer totals.

PLUs, Departments, Main groups

Classifies the financial data according to departments, PLUs or main groups.

Journal

Records all actions carried out on the POS system (programming and financial data) since the last Z-report.

In case of transactions, operators, operators (single), departments, PLUs, main groups and hourly report you can choose between different report levels. For instance there may be a level for daily reports and another level for weekly reports. At the end of a day you can print Z-reports of level 1, at the end of a week you can print those of level 2. For some reports you may also select an evaluation range and print the report only for selected PLUs.

Due to the amount of data, the printing of invoices, clerk reports and journals may take quite some time.

12.4. Input and output

12.4.1. Input of amounts

Amounts are generally entered into the POS system with two decimals. The dot can also be omitted. For ten Dollars enter "1000" or "10.00", for 3.95 Dollars "395" or "3.95".

12.4.2. Screen windows

Depending on the programming different windows are available on the screen. The most important will be explained here. By means of the key <go to window> you can switch between the individual windows or select new ones.

Overview on open GCs / open hold buffers

Displays all those GCs and hold buffers which have been opened by the currently signed-in operator. It also shows the total sales for each GC or hold buffer.

Receipt window

Displays the current receipt or invoice.

Info window

Displays the last entry or information on current actions such as "Void" or "GC split".

Input window

Here you enter amounts or PLU numbers.

GC window

Displays all PLUs of the currently opened GC that have not yet been paid.

12.5. Making a sale

The usual procedure is as follows:

- PLUs or prices are entered
- The sale is invoiced and passed to the customer
- The customer pays

The details of each of these steps are explained in the following. A operator must be signed-in (see above).

12.5.1. Input of PLUs

There are different ways to enter PLUs:

- Enter the PLU number, followed by the <PLU> key or ^{PLU}
- Press the direct PLU-key (e.g. <Small Coke>)
- Scan the bar code of the PLU



12.5.2. Free price input

When you enter a PLU (see above), it will sell for its preset price. You may also enter a different price, e.g. for goods with small faults that you want to sell cheaper.

Free price input can be locked at your POS system or only be possible for selected operators.

To carry out free price input, enter a price and select the corresponding PLU or department. Before selecting PLU or department you may have to press the <Price> button.

12.5.3. Payment

The GC is closed after all PLUs have been entered and the customer wants to pay. The signed-in operator can press the <Subtotal> key or  to see the subtotal. The sum is displayed and can be told to the customer. Enter the amount you get from the customer and press <Cash> or . The change is displayed and the receipt is printed. If the customer pays the exact amount you can directly depress <Cash> or  without entering an amount.

If the customer does not pay cash, press the respective media key, e.g. <EC> or <Visa> instead of <Cash> or .

12.6. Void and merchandise return

Void and merchandise return are similar functions.

Void serves to cancel entries.

Merchandise return is a negative account where goods are taken back and money is paid out or deducted from the open balance.





Note

Void or merchandise return is only possible if the operator has been vested with the required authorization. The authorization for every operator has to be elaborated and configured together with your Vectron dealer (see chapter 12.8).

12.6.1. Void LE

Pressing the <Void LE> key or  deletes the last entered PLU.

12.6.2. Void

If you want to delete another PLU, press the <Void> key or  and select the PLU to be deleted via direct PLU key or PLU number (see above). If you want to delete additional PLUs, press the <Void> key or  again.

12.6.3. Merchandise return

When working in a guest check, it is only possible to return those PLUs that have previously been sold on this guest check. When working in a cash sale, you may return any PLUs.

To carry out a merchandise return press the <Merchandise Return> key. The further procedure is identical with "Void".

12.7. Change invoice format

Your dealer has adapted the invoice format according to your requests. It may sometimes be necessary to change the format, e.g. to print a receipt for entertainment expenses. In this case press the <Change invoice format> key before closing the invoice.

12.8. Access rights

In order to avoid improper changes in the programming of the POS system you can assign different access rights to the various functions and program sections. Protection can be effected by key, by password and by unambiguous access restriction and can be assigned individually for each operator.

VECTRON POS HARDWARE

Unauthorized access can have e.g. the following effects during operation:

- manipulations with financial damage for the owner
- undesired behaviour in programming mode
- data loss
- illegal behaviour of the POS system

Please contact your Vectron dealer who will inform you about the useful and required security measures for your POS system. He will configure the POS system accordingly to protect the programming from unauthorized access.



Attention!

Please note:

In this context we explicitly point out that every taxpayer himself is responsible for a correct accounting. For more information please contact the local fiscal authorities or a tax adviser. Vectron Systems AG as producer and the sales partners dealing with our products are not entitled to act as someone's adviser.

12.9. Final remark

We hope that we were able to give you some helpful information about your Vectron POS system. Due to the numerous programming possibilities, the description had to be quite general and the information restricted to the main functions. Your Vectron dealer will gladly answer any of your questions.

Please visit our Internet site (www.vectron.de). Here you get additional information and you can send us your questions by e-mail if necessary.

13. Service and maintenance

The POS system does not contain any parts that can be serviced by the user. Please leave all maintenance and service to the retailer.



Attention!

Do not carry out any maintenance or service on your own. Only authorized service staff may open the cabinet.

Unauthorized manipulations at the power supply Vectron PS10 may be extremely dangerous and lead to a loss of guarantee and liability claims.

13.1. Cleaning the cabinet

To clean your Vectron POS system please use a dry, fluff-free cloth. In case of strong contamination you can wipe the cabinet carefully with a damp cloth that is soaked with a mild cleaner.

13.2. Cleaning the display

To clean the display of your Vectron POS system please use a clean, soft cloth, soaked with isopropyl alcohol if necessary.



Attention!

- Disconnect the POS system from the power supply before cleaning.
- In no case you should use a scouring agent or agents containing solvents or acids!

13.3. Screen saver

The Vectron POS systems POS Vario, POS ColorTouch and POS Mini have high-quality LCD screens with background lighting. The tubes of the background lighting have a service life of 45,000 to 50,000 hours.

This service life is considerably reduced by a frequent switch on and off. An activated screen saver starts the switch on and off, therefore the interval for the activation of the screen saver should not be too short.

Yet, if the interval is very long, the displayed elements could burn in the LCD screen. This means that you can hardly recognize the elements and operate them in case of touch screens.

To avoid these problems we recommend to activate the screen saver after approximately 30 minutes.

Please ask your Vectron dealer to check the interval of the screen saver and adjust it to 30 minutes if necessary.

14. Additional Vectron products

Here we would like to inform you on additional Vectron products, which perfectly complete the stationary Vectron POS 64-Bit hardware.

14.1. Vectron POS Modular

Vectron POS Modular offers manifold applications. It is not only suitable as single station system but is also recommended as central server in ECR networks. Thanks to numerous peripherals it can be adjusted to any surroundings and remains state of the art. POS Modular and stationary 64-Bit POS systems are based on the same hard- and software. The two stationary product lines complete each other perfectly when installing a local Client/Server system.

14.2. Vectron POS MobilePro

The Vectron POS MobilePro is the mobile model of Vectron POS systems. It is also based on 64-Bit hardware and also uses the proven Vectron POS software. This makes stationary and mobile Vectron POS systems completely compatible.

VECTRON POS HARDWARE

The chart below shows the most important features of stationary, modular and mobile systems.

	Vectron POS System				
	Modular	Color-Touch	Mini	Vario	Mobile-Pro
Colour display	●	●	●	●	●
Touch screen	●	●	●	●	●
Int. customer displ.	○	●	●	●	○
64-Bit Processor	●	●	●	●	●
SRAM, extendable	2 MB, ●	2 MB, ●	2 MB, ●	2 MB, ●	4 MB, ●
DRAM	64 MB	64 MB	64 MB	64 MB	64 MB
FlashROM	8 MB	8 MB	8 MB	8 MB	8 MB
Network	Ethernet LAN	Ethernet LAN	Ethernet LAN	Ethernet LAN	WLAN
Ports					
• serial	6	6	6 ●	6	○
• parallel	1	1	1 ●	1	○
• USB	2	2	2	2	○
• Cash drawers	2	2	2	2	○
• PS/2	1	1	1	1	○
• Bluetooth	○	○	○	○	●
Transponder	○	○	○	○	●
Int. card reader	○	○	○	○	●
Powermanagement	○	○	○	○	●
Operator lock	●	●	●	●	● ¹⁾

● = standard equipment, ● = optional, ○ = not available

¹⁾ To be realized per Transponder reader

For further information on Vectron POS systems please refer to the Internet under www.vectron.de.

14.3. Vectron POS PC

Vectron POS PC runs the Vectron POS software on your PC. Prerequisite is a PC with Microsoft® Windows® operating system. The advantage of Vectron POS PC is that you can use the Vectron POS software simultaneously with E-Mail-, office- and stock control applications. This allows data exchange within seconds.

For further information on Vectron POS PC please refer to the Internet under www.vectron.de.

14.4. Vectron Commander

The Vectron Commander is a communication- and evaluation software for PCs with Microsoft® Windows® operating system. A connection to the Vectron POS system enables the Vectron Commander to poll and evaluate the cash register data. You are informed on sales-, order- or working time data etc.

For further information on the Vectron Commander please refer to the Internet under www.vectron.de.

15. EU declaration of conformity

Manufacturer	Vectron Systems AG Willy-Brandt-Weg 41 48155 Muenster / Germany
Device type	Electronic cash registers
Type designation	Vectron POS Vario Vectron POS ColorTouch Vectron POS Mini

The manufacturer declares that the above designated products comply with the fundamental standards of guideline 2004/108/EC (EMC directive) and 2006/95/EC (Low-voltage directive) when used as directed.

Applied standards:

- EN 55022:2006 + A1:2007
- EN 55024:1998 + A1:2001 + A2:2003
- EN 61000-3-2:2006
- EN 61000-3-3:2008
- EN 60950-1:2006

Muenster, March 25th, 2011

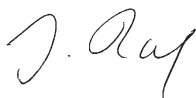

Jens Reckendorf
Member of the Board



Thomas Stümmler
Member of the Board

Supplement

Important notes for the connection of scales

- When connecting scales you have to heed the respective national regulations. Within the EU it applies: You require a test certificate for the respective combination of Vectron POS System, software and scales. The conditions mentioned therein must be fulfilled.

- **Check of certified software**

Proceed as follows to check that the Vectron POS system runs the correct software:

- Switch off the POS system.
- Touch the screen and keep it touched.
- Switch on the POS system.
- Touch the screen until „Starting drivers ...“ and then „Calibration is cleared in n seconds“ is displayed.
- Touch the „Module inform.“ button.

„Scale generic protocol 02/04 Version 1.01a“ must be displayed (see below).

Modul informationen		✓
Modul	Version	
Scale generic protocol 02/04	1.01a	▲
Scale TOWA protocol, Cmd Mode	1.00a	▼
		⌵

Navigation icons: ⏪ ⏩ (bottom left and right)

VECTRON POS HARDWARE

Piktographs

The Vectron POS software as of version 4 has installed a set of icons, which can be used in registration mode. The chart below lists the available icons.

Icons and their meaning

Icon	Meaning	Icon	Meaning
	Clear		Seat number
	Escape		PLU
	Take away		Invoice
	Cancel receipt		Load invoice
	Receipt copy		Recall invoice
	Guest count		Invoice copy
	Inhouse		Seat split
	No invoice		Void
	Operator		Void last entry
	Manager function only		GC

Icon	Meaning	Icon	Meaning
	Open GC/Operator		GC 0
	GC split		Side dishes
	Shift change		Beer
	GC move		Icecream
	Table map		Fish
	Enter GC text		Meat
	X-report		Drinks
	Z-report		Main courses
	Temp. invoice		Dessert
	Subtotal		Pizza
	Cash		Spirits
	Cold drinks		Starters
	Hot drinks		Wine

VECTRON POS HARDWARE

The vectron POS software can also use self-created or edited icons of a second icon set. You can either display these icons on buttons or link them to a PLU.

These icons must be edited and brought to a defined format. Please ask your local dealer if you want to create and use your own icons.

Glossary

Term	Defintion
Barcode	Code on a merchandise that consists of vertical bars.
Cash drawer	Drawer in which cash is kept, connectable to a cash register system.
CE	Duty for marking all devices, manufactured in or imported into the EU, verifying conformity with EU standards and regulations.
CSTN	C olor S uper- T wist N ematic. LCD technique, where pixels are addressed by transistors, which can address a whole line or column.
Ethernet	A standardized network protocol, used for interconnecting computers and networks.
Flash-ROM	In contrast to ROM, Flash-ROM is a recordable memory type. Here, the ECR software of Vectron POS systems is stored.
Hardware	Physical components of a computer and its peripherals.
Identification lock	For sign in and out of the operators.
Internet	Worldwide computer network, consisting of various interconnected networks.
LCD	L iquid C rystal D isplay; a layer of liquid chrystals is given in between two foils. When a voltage passes through these chrystals, they change the angle of optical refraction.
Network	Group of computers that are connected via different lines and share common resources like data and peripherals.
Network port	Port via which several computers or ECRs can be connected.
Operator key	For sign in and out of the operators.
Parallel port	Port that allows simultaneous data transmission on eight lines.

VECTRON POS HARDWARE

Term	Defintion
Pixel	Smallest element of a digital image with defined coordinates, regarding location and color.
Port	Connection between computers or computers and peripherals.
POS	P oint O f S ale.
PS/2	PC-System developed by IBM with independent ports, which are also used on other platforms.
RAM	R andom A ccess M emory, every storage cell of which can be accessed at will. RAM modules are volatile memory modules. They loose their contents, if no voltage is applied. see also SRAM.
S creen saver	Serves for protection of screens. After an adjustable period of system inactivity, the display either permanently changes or the screen is switched off. The screen saver is stopped as soon you touch an input device (keyboard, touch screen).
Serial port	Port, which transfers data bit by bit.
Software	Heading for every type of computer programs.
SRAM	Static RAM. A permanent quiescent current preserves the stored information. In switch off mode, this quiescent current is maintained by an internal battery.
TFT	T hin F ilm T ransistor. Display technique, which offers a higher contrast and a better image than customary flat screens.
Touch screen	Touch-sensitive screen with input function.
U ppdate	Loading the most current software into the respective hardware.

Document revision

Date	Alteration
Sept. 15th, 2003	First creation and publication
March 15th, 2004	Second edition
Sept. 15th, 2004	Third edition
Dec. 15th, 2004	Additions regarding to Vectron POS Mini with TouchScreen, particularly chapter 8.4
Jan. 24th, 2005	Fourth edition Chapter 9.5 added
March 4th, 2005	Chapter 12.3 added
June 24th, 2005	Fifth edition
July 13th, 2005	Minor changes
Dec. 6th, 2005	Sixth edition
April 25th, 2006	Seventh edition • Chapter 9.5 removed • Chapter 13 revised • Minor editorial changes
May 31st, 2006	• Piktographs added (see chapter 11 and supplement) • Chapter „Important notes for the connection of scales“ added (see supplement)
October 10th, 2006	Eighth edition
Jan. 22nd, 2007	Ninth edition
May 8th, 2007	Tenth edition
Sept. 7th, 2007	Eleventh edition
Jan. 28th, 2008	Twelfth edition
May 16th, 2008	Thirteenth edition • Minor editorial changes
Sept. 29th, 2008	Fourteenth edition
April 20th, 2009	Fifteenth edition • Chapter 2 added • Minor editorial changes
March 25th, 2011	Sixteenth edition Chapter 15 revised

