

DYNACODE

Interface Description



Copyright by Carl Valentin GmbH / 7957015.0815

Information on the scope of delivery, appearance, performance, dimensions and weight reflect our knowledge at the time of printing.

We reserve the rights to make modifications.

All rights, including those regarding the translation, are reserved.

No part of this document may be reproduced in any form (print, photocopy or any other method) or edited, copied or distributed electronically without written permission from Carl Valentin GmbH.

Due to the constant further development of our devices discrepancies between manual and device can occur.

Please check www.carl-valentin.de for the latest update.

Trademarks

All named brands or trademarks are registered brands or registered trademarks of their respective owners and may not be separately labelled. It must not be concluded from the missing labelling that it is not a registered brand or a registered trademark.

Carl Valentin direct print modules comply with the following safety guidelines:

- CE** EG Machinery Directive (98/37/EC)
- EG Low-Voltage Directive (2006/95/EC)
- EG Electromagnetic Compatibility Directive (89/336/EEC)



Carl Valentin GmbH

Postfach 3744

78026 Villingen-Schwenningen

Neckarstraße 78 – 86 u. 94

78056 Villingen-Schwenningen

Phone +49 (0)7720 9712-0

Fax +49 (0)7720 9712-9901

E-Mail info@carl-valentin.de

Internet www.carl-valentin.de

SERIAL DATA TRANSMISSION.....	1
XON / XOFF - Protocol.....	1
Connector assignment (9-pin DSUB socket).....	1
Connecion RS 232.....	2
Connector assignment RS485 and RS422.....	3
PARALLEL DATA TRANSMISSION	4
Connection	5
ROTATION OF TEXT, CODE AND GRAPHIC	6
DATUMPOINT.....	6
DATA FORMAT.....	7
Explanations.....	8
Definition of field attributes/field properties (optional).....	9
Field names.....	10
Field selection by free definable field number.....	11
Foreground and background	12
MASK SET	13
Text	13
Standard code	15
2D bar codes	17
Rectangle	25
Line.....	25
Internal graphic.....	26
TEXT SET	27
GRAPHIC	29
General graphic format.....	29
Graphic in PCX format.....	30
VARIABLES	32
Set structure	32
Link field	32
Counter.....	33
Extended counter	34
Date / Time	35
Currency variable	39
Shift variable.....	40
User guiding	41
User guiding with mask	42
Memory card data.....	43
GS1-128 Parser.....	43
EPC calculation (Electronic Product Code)	44

Check digit.....	45
Substring	46
PARAMETER SETS.....	47
Layout parameters.....	47
Device parameters	51
Interface	55
Network	57
Sensors	60
Service functions	61
Date & Time.....	64
Password.....	67
Compact Flash Card.....	68
Printing	70
Remote console.....	73
Emulation	73
PARAMETER SETS FOR CONTINUOUS MODE	74
Machine parameters.....	74
Ribbon save.....	76
I/O parameters.....	78
PARAMETER SETS FOR INTERMITTENT MODE	80
Machine parameters.....	80
I/O parameters.....	81
AUTOSTATUS	85
CHARACTER SETS.....	87
International ANSI character font.....	89
Codepage 437	90
Codepage 850.....	91
Codepage 852.....	92
Codepage 857.....	93
GEM German	94
GEM English.....	95
GEM French	96
GEM Swedish.....	97
GEM Danish	98
FONT EXAMPLES	99
Bitmap fonts (not proportional)	99
Bitmap fonts (proportional)	99
Vector fonts	99
INDEX	99

SERIAL DATA TRANSMISSION

XON / XOFF - Protocol

The XON / XOFF protocol is used in "memory"-mode. The XON-code (HEX 11) indicates that the print module is ready to receive data. When XOFF-code (HEX 13) is shown the transmission of data has to be interrupted. To avoid possible data loss some information will be stored into the data-memory. When receiving, that the memory is empty the XON-code (HEX 11) will be shown again.

Connector assignment (9-pin DSUB socket)

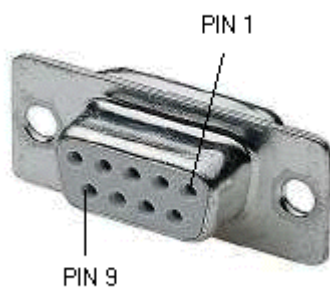

Pin	Signal	Beschreibung
2	R x D	Receiving data line
3	T x D	Transmitting data line
4	DTR	HW Handshake
5	GND	GND Signal

Conecion RS 232

Terminal assignment (cable)

XON / XOFF - report: e.g. connection to an IBM-compatible computer

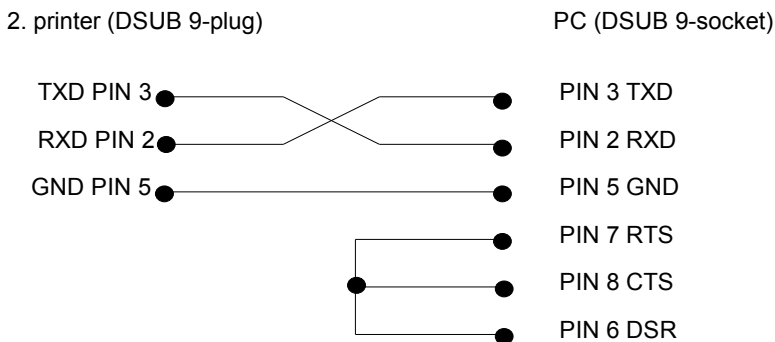
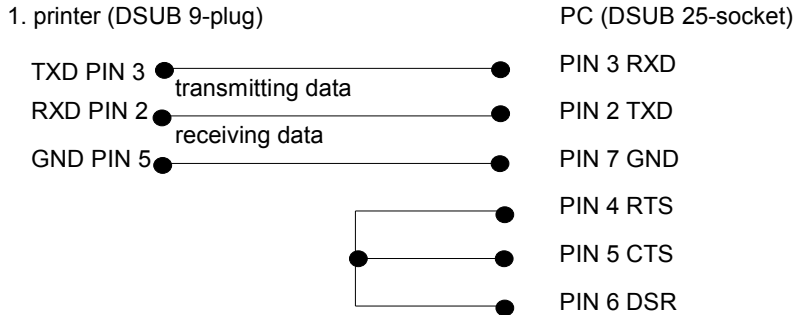

Hardware handshake:

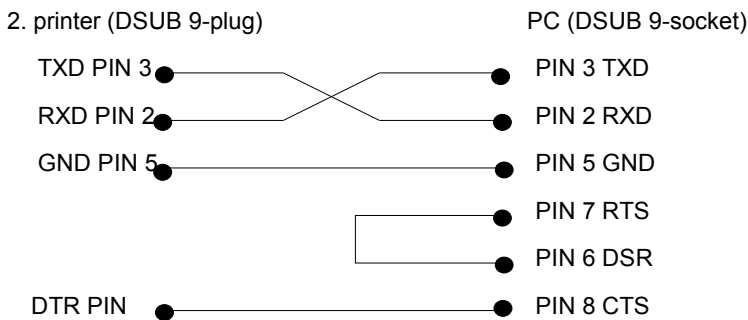
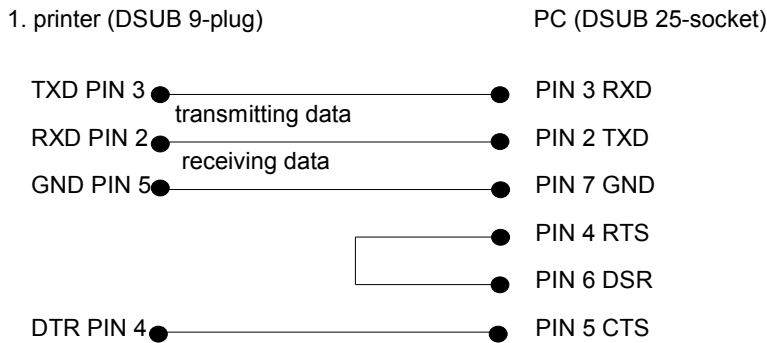

Connector assignment RS485 and RS422

9-pin DSUB socket)

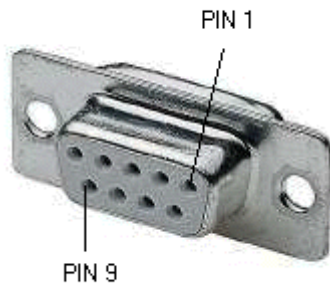

PIN at DSUB socket	Function RS422 (full duplex)	Function RS485 (semi duplex)
1	GND	GND
2	n/c	n/c
3	n/c	n/c
4	RxD-	n/c
5	RxD+	n/c
6	n/c	TxD (RxD)-
7	n/c	TxD (RxD)+
8	TxD-	n/c
9	TxD+	n/c

PARALLEL DATA TRANSMISSION

Interface:	parallel Interface
	synchronising with STROBE - signal
	handshake with BUSY - signal
	all signals are TTL - compatible
Connection:	AMPHENOL - plug 57-30360
PIN 1	In regular condition, this signal is in "HIGH" position. With decreasing amplitude the data acceptance is completed from DATA 1 DATA 8.
PIN 2 . . . 9	DATA 1 DATA 8 parallel data information
PIN 10	<u>ACKNLG</u>
PIN 11	In regular condition this signal is "LOW". With decreasing amplitude of STROBE- signals, BUSY will change onto "HIGH" - level. This level will stay as long as the print module is busy with the already received data byte.

Connection

AMP 36 (Centronic's socket)

Signal Pin-No.	Signal name	Direction	Function
1	$\overline{\text{STROBE}}$	(input)	The $\overline{\text{STROBE}}$ signal indicates that data can be received. The impulse width to the receiving line has to be 0,5 μs at least.
2	DATA 0	(input)	The signals are data bits sent to the print module. A HIGH level corresponds to logical 1 and a LOW level to logical 0.
3	DATA 1	(input)	
4	DATA 2	(input)	
5	DATA 3	(input)	
6	DATA 4	(input)	
7	DATA 5	(input)	
8	DATA 6	(input)	
9	DATA 7	(input)	
10	$\overline{\text{ACKNLG}}$	(output)	An impulse of approx. 12 μs confirms data input for a LOW level and signals the further listening watch of the print module.
11	BUSY	(output)	A HIGH level indicates that the print module cannot receive any data. On the following conditions the signal HIGH is possible: <ol style="list-style-type: none"> 1) for data input (impulse for each sign) 2) during a printing process 3) in Offline status 4) for print module failures
12	PE	(output)	A HIGH level indicates that paper is used up.
13	SELECT	(output)	High Online
14	AUTOFEED		
15	GND		
16	GND		Signal ground.
17	CHASSISGND		Mass, not connected with signal ground.
18	+ 5V		Approx. 4,8 V (max. 100mA)
19-30	GND		Return conductor for twisted pair conductors.
31	not used		-
32	$\overline{\text{FAULT}}$	(output)	Signal goes to LOW, in case <ol style="list-style-type: none"> 1) the paper is used up 2) the print module is Offline or <ol style="list-style-type: none"> 3) an error occurs.
33	not used		
34	not used		
35	not used		
36	not used		

ROTATION OF TEXT, CODE AND GRAPHIC

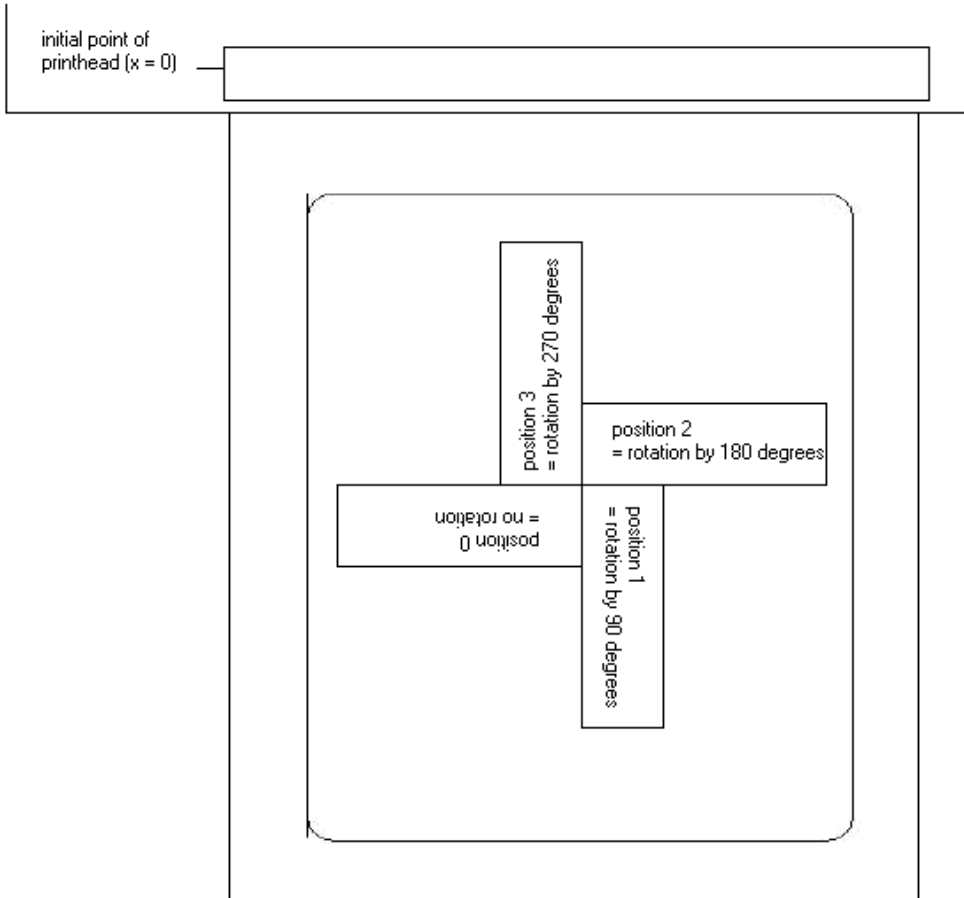

DATUMPOINT

The so-called datum point is the relation point for indication of position. In the meantime the datum point is also the point at which the selected object is rotated.

To determine the datum point in the mask sets, the possible datum points are numbered from left top (1) to right bottom (9). The default datum point is left bottom (7). This datum point is also used even if no indication is found in the mask set.

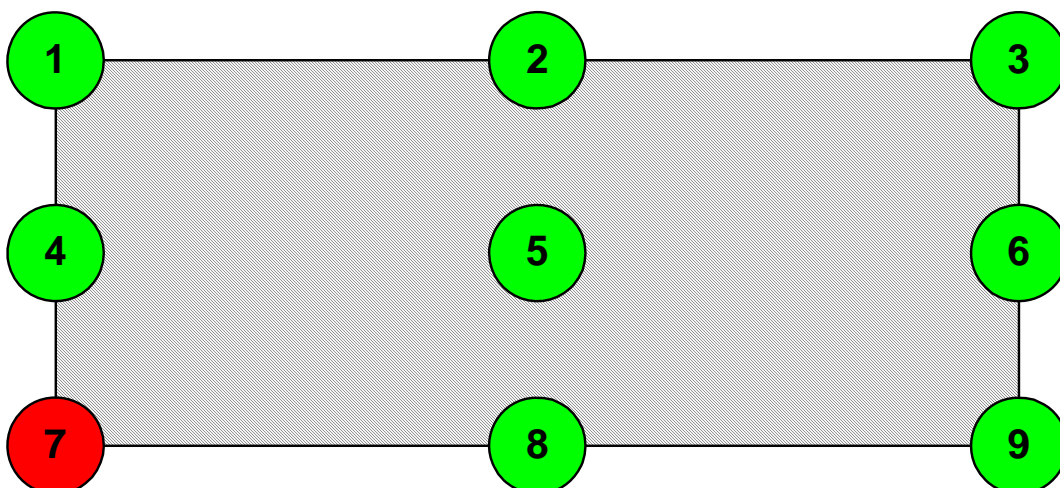

DATA FORMAT

The format of data consists of 4 parts, the mask part, the text, the code (if necessary) and the command part.

For a n-line layout the following has to be transmitted:

n	mask sets
n	text sets
n	graphic sets (if necessary)
1	command set

The command set always has to be transmitted at the end!

To each text on a layout belongs one MASK SET and one TEXT SET with the same field number.

To each code on a layout belongs one MASK SET, one TEXT SET and one CODE SET with the same field number.

To each box or line on a layout belongs only one MASK SET.

To each graphic on a layout belong several GRAPHIC SETS according to its size res. height, e.g. a graphic with a height of 10 mm needs 80 graphic sets.

Examples:

layout with 3 lines text:	3 mask sets 3 text sets 1 command set
layout with 3 lines text and 1 code:	4 mask sets 4 text sets 1 code set 1 command set
layout with 2 lines text, 1 box and 3 lines:	6 mask sets 2 text sets 1 command set

For all data sets the following is valid:

Each set starts with: **SOH = start of header** → HEX format 01

and ends with: **ETB = end of data transmission block** → HEX format 17

Alternatively it is possible to set SOH to 5E_{Hex} and ETB to 5F_{Hex}. This is necessary if the connected system (e.g. UNIX) cannot transfer control signs.

All other data sets → ASCII format, but they will be transmitted as hexadecimal characters.

Example: A = identification of mask set - transmission: 41_{HEX}
n = field number '01' - transmission: 30_{HEX}, 31_{HEX}

Explanations

- x coordinate: distance from right layout rim in mm
is measured from the right layout rim up to the lower left point of the corresponding line
- y coordinate: distance from upper layout rim in mm
is measured from the beginning of the layout down to the lower left point of the corresponding line
- Bitmap fonts not proportional: bitmap fonts - not proportional (Matrix – mm)
- | | | |
|--------------|--------------------------|------------------|
| 01 = FONT 01 | 0,8 x 1,1 mm | - 127 characters |
| 02 = FONT 02 | 1,2 x 1,7 mm | - 255 characters |
| 03 = FONT 03 | 1,8 x 2,6 mm | - 255 characters |
| 04 = FONT 04 | 4,0 x 5,6 mm | - 127 characters |
| 05 = FONT 05 | 1,8 x 3,2 mm - descender | - 255 characters |
| 06 = FONT 06 | 1,5 x 2,9 mm | - 127 characters |
| 07 = FONT 07 | 1,2 x 2,2 mm - descender | - 255 characters |
- Bitmap fonts proportional: bitmap fonts – proportional
- | | | |
|--------------|-------------------|------------------|
| 21 = FONT 21 | 1,0; 9 (1,0; 13) | - 255 characters |
| 22 = FONT 22 | 1,8; 14 (1,8; 21) | - 255 characters |
| 23 = FONT 23 | 2,6; 21 (2,6; 31) | - 255 characters |
| 24 = FONT 24 | 5,6; 45 (5,6; 67) | - 255 characters |
| 28 = FONT 28 | 4,0; 32 (4,0; 48) | - 255 characters |
| 29 = FONT 29 | 0,8; 6 (0,8; 9) | - 255 characters |
- To reach best print results it is recommended always to chose the biggest possible font.
- Vector fonts proportional text: When in mode "proportional text", the height and width of text have to be entered in mm.
These values refer to the capital "M", i.e. the values of other characters are changing in proportion.
- Vector fonts autoscale: When in autoscale mode, height and width of text has to be entered in mm.
The height of the text refers to all capital letters. When using small characters and descenders the height is changing in proportion. When entering the width, the complete file has to be considered. The text will be adjusted automatically, which means that the width of the characters is changing.

Definition of field attributes/field properties (optional)

Explanation: Additionally to mask set 'AM[] ...' the possibility was created to define further field properties. In order to achieve a high flexibility, the field properties received own names/identifications. Therefore the sequence as well as the number of field properties are free. If necessary, the mask set 'AC[]' is transferred additionally to mask set 'AM[]' to the printer.

Structure mask set: (SOH)AC[]at1=*value*;at2= *value*;...(ETB)

Attribute (at):	Description
BT BW QZ	ITF 14 (see chapter 'Mask set ITF code') Bearer bar type Bearer bar width Quiet zone in 1/100 mm
NAME	Field name (see page 10) Definition of field name
FN	Field number (see page 11) Free definable field number
BGND FGND	Foreground and background (see page 12) Background of field Foreground of field

This table is constantly extended. The current version is available on demand.

Field names

Application (customized)

1. The label is created with Labelstar Office/Labelstar PLUS.
2. Label data are saved on memory card of printer.
3. An external control (SPS, balance, ERP system, etc.) modifies variable fields of the label (e.g. weight, article no., batch no., etc.) and starts the print of label.

Explanation (Labelstar PLUS only)

So far the fields were designated by numbers (1, 2, 3, ...) which were determined by the order of creation in Labelstar PLUS. By later modifications of label, these field numbers were possibly changed whereby the access to a certain field was no longer possible. By the field names this dependence is annulled.

Procedure - Labelstar PLUS

- a) - Entry of 'Field identifier'.

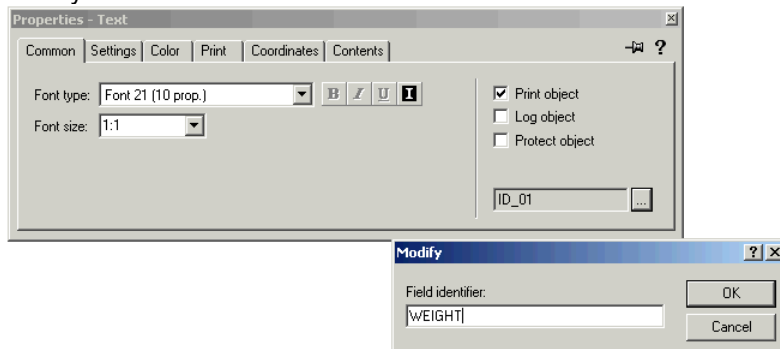

- Selection of option 'Transmit field identifier'.

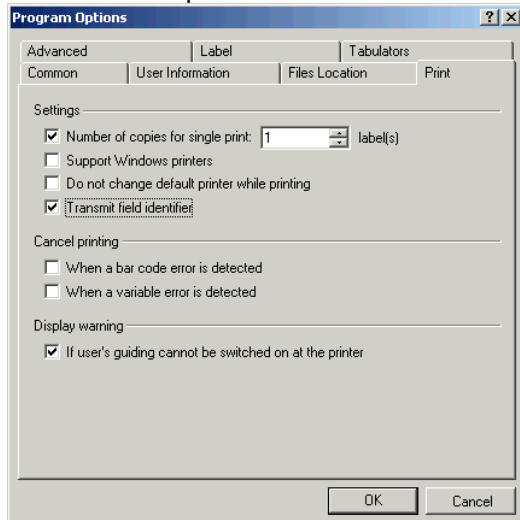

- b) Save label on memory card of printer.
- c) The external control loads first the saved label from memory card of printer with **(SOH)FMB---rF(ETB)**
See chapter 'Memory card'.
- d) With text set **(SOH)BV[NAME]...(ETB)** the contents of field is determined.
- e) With parameter set **(SOH)FBC---rS------(ETB)** the print is started.
See chapter 'printing'.

Procedure - Labelstar Office

- a) The names of field identifiers are assigned and transferred automatically from Labelstar Office to the printer.
- b) Save label on memory card of printer.
- c) The external control loads first the saved label from memory card of printer with **(SOH)FMB---rF(ETB)**
See chapter 'Memory card'.
- d) With text set **(SOH)BV[NAME]...(ETB)** the contents of field is determined.
- e) With parameter set **(SOH)FBC---rS------(ETB)** the print is started.
See chapter 'printing'.

Field selection by free definable field number

With the following described attribute it is possible to assign a free definable field number to a field. This field number does not have to be clear, i.e. several fields can have the same field number. In this way the same field contents can be assigned to different fields.

The following attribute identification is defined:

Attribute	Description
FN	free definable field number

After the field number was assigned with AC mask statement,

(SOH)AC[n]FN=nr(ETB)

n = field index

nr = free definable field number

it is possible to access to the field and/or the fields with the new BF text statement:

(SOH)BF[nr]text(ETB)

nr = field number

text = field contents

Example

```
// Assignment of field number for field 1 and field 2
(SOH)AM[1]1000;2500;0;4;2;7;400;400;0(ETB)
(SOH)AC[1]FN=100(ETB)
(SOH)AM[2]2000;2500;0;30;2;4000;9;3;0;1(ETB)
(SOH)AC[2]FN=100(ETB)

// Access to field 1 and field 2 by field number
(SOH)BF[100]1234567890(ETB)
```

Foreground and background

For following objects/fields the foreground and background can be specified explicitly:

- Bitmap text (only foreground)
- TrueDoc text (only foreground)
- Graphic from memory card (only foreground)
- Line (only foreground)
- Rectangle (only foreground)
- QR Code (only foreground)
- GS1 DataBar (RSS) (only foreground)
- CODABLOCK (only foreground)
- DataMatrix (only foreground)
- PDF417 (only foreground)
- CODABAR (only foreground)
- Code 128 (only foreground)
- Code 2/5 interleaved (only foreground)
- Post Leitcode (only foreground)
- Post Identcode (only foreground)
- ITF 14 (only foreground)
- Code 39 (only foreground)
- Code 39 extended (only foreground)
- Code 93 (only foreground)
- EAN ADD ON (only foreground)
- EAN 13 (only foreground)
- EAN 8 (only foreground)
- GS1-128 (only foreground)
- Pharmacode (only foreground)
- PZN Code (only foreground)
- UPC A (only foreground)
- UPC E (only foreground)

The following attribute identification is defined:

BGND	Background of field
FGND	Foreground of field

The following values can be assigned to the attributes:

0	black
1	white
2	inverted
3	transparent
4	standard

- black: The field contents is generated in black onto the label (previous standard).
white: The field contents is generated in white onto the label.
inverted: The field contents is generated inverted to the background onto the label.
transparent: The field contents is generated transparent onto the label – no change of contents that is generated till then.

If the attribute for the background is set, this effects on all fields within this range, generated so far. With the selection of white or black the fields beneath are covered. If inverted is selected then they change their color.

The attribute value for the foreground always refers to the current background. If no attribute is explicitly set, all generated fields so far in this sector are regarded as background.

At the generation, alwayst the first attribute for the background (if set) and then the attribute for the foreground (if set) is processed.

Example:

```
// Creation of field for bitmap text
(SOH)AM[1]2000;5000;0;1;0;21;2;2;50;7(ETB)

// Text field contents
(SOH)BM[2]Inverted text(ETB)

// Invert text field
(SOH)AC[2]BGND=3;FGND=2(ETB)
```

MASK SET

Text

AM[n]y;x;p;a;d;z;dy;dx;lp;dp	
A	identification for mask set
M	identification for protocol version
n	field number
y	Y coordinate in 1/100 mm
x	X coordinate in 1/100 mm
p	identification for phantom field 0 = print 1 = no print
a	identification for field type 1 = Bitmap Font 2 = Bitmap Font inverse 3 = Vector Font proportional 4 = Vector Font Autoscale 5 = Vector Font proportional inverse 6 = Vector Font Autoscale inverse
d	rotation 0 = 0° 1 = 90° 2 = 180° 3 = 270°
z	character font for not proportional Bitmap fonts (1+2) 01 = FONT 01 0,8 x 1,1 mm 127 characters 02 = FONT 02 1,2 x 1,7 mm 255 characters 03 = FONT 03 1,8 x 2,6 mm 255 characters 04 = FONT 04 4,0 x 5,6 mm 127 characters 05 = FONT 05 1,8 x 3,2 mm - descender 255 characters 06 = FONT 06 1,5 x 2,9 mm 127 characters 07 = FONT 07 1,2 x 2,2 mm - descender 255 characters
	character font for proportional Bitmap fonts (1+2) 21 = FONT 21 (1,0; 13) 255 characters 22 = FONT 22 (1,8; 21) 255 characters 23 = FONT 23 (2,6; 31) 255 characters 24 = FONT 24 (5,6; 67) 255 characters 28 = FONT 28 (4,0; 48) 255 characters 29 = FONT 29 (0,8; 9) 255 characters
	character font for vector fonts (4-7) 01 = Helvetica Bold 02 = Helvetica Bold italics 03 = Helvetica Roman 04 = Helvetica Roman italics 05 = Swiss Light 06 = Swiss Light italics 07 = Baskerville 08 = Baskerville italics 09 = Brush Script 10 = Brush Script italics 11 = Monospace 12 = Monospace italics 17 = OCR-A 18 = OCR-A italics 19 = OCR-B 20 = OCR-B italics

dy	extension in direction Y Bitmap fonts factor 0...9 Vecor fonts character size in 1/100 mm Vector fonts Autoscale field height
dx	extension in direction X Bitmap fonts factor 0-9 Vector fonts character sign in 1/100 mm Vector fonts Autoscale field width
lp	distance between single characters in 1/100 mm
dp	datumpoint 1 = left top 2 = centre top 3 = right top 4 = left centre 5 = centre centre 6 = right centre 7 = left bottom (default) 8 = centre bottom 9 = right bottom

Standard code

AM[n]y;x;p;a;d;h;v1;v2;pz;z;dp	
A	identification for mask set
M	identification for protocol version
n	field number
y	Y position in 1/100 mm
x	X position in 1/100 mm
p	identification for phantom field 0 = print 1 = no print
a	identification for field type 30 = Code 39 31 = Code 2/5 interleaved 32 = EAN 8 33 = EAN 13 34 = UPC A 35 = UPC E 36 = CODABAR 37 = Code 128 38 = EAN ADD ON 39 = GS1-128 40 = Code 93 41 = PZN 7 42 = 2/5 Industrie 43 = Leitcode 44 = Identcode 46 = Code 39 extended 47 = Code 128 A 48 = Code 128 B 49 = Pharmacode 60 = PZN 8
d	rotation 0 = 0° 1 = 90° 2 = 180° 3 = 270°
h	height of symbol in 1/100 mm
v1	relation 1; module width 'THICK'
v2	relation 2; module width 'THIN' res. SC factor
pz	check digit calculation 0 = no check digit calculation 1 = check digit calculation 4 = inverse - no check digit calculation 5 = inverse - check digit calculation
z	human readable line 0 = no human readable line 1 = with human readable line
dp	datapoint 1 = left top 2 = centre top 3 = right top 4 = left centre 5 = centre centre 6 = right centre 7 = left bottom (default) 8 = centre bottom 9 = right bottom

ITF Code

AM[n]y;x;p;a;d;h;v1;v2;pz;z;dp	
A	identification for mask set
M	identification for protocol version
n	field number
y	Y position in 1/100 mm
x	X position in 1/100 mm
p	identification for phantom field 0 = print - 1 = no print
a	identification for field type 56 = ITF 14
d	rotation 0 = 0° 1 = 90° 2 = 180° 3 = 270°
h	height of symbol in 1/100 mm
v1	relation 1; module width 'THICK'
v2	relation 2; module width 'THIN' res. SC factor
pz	check digit calculation 0 = no check digit calculation 1 = check digit calculation 4 = inverse - no check digit calculation 5 = inverse - check digit calculation
z	human readable line 0 = no human readable line 1 = with human readable line
dp	datapoint 1 = left top 2 = centre top 3 = right top 4 = left centre 5 = centre centre 6 = right centre 7 = left bottom (default) 8 = centre bottom 9 = right bottom

In order to print the bearer bars of an ITF 14 barcode, the following additional properties for Code 2/5 interleaved must be set:

For this the following field properties are determined:

Property identifier	Description
BT	bearer bar type 0 = no bars 1 = above/below 2 = rectangle
BW	bearer bar width in 1/100 mm
QZ	quiet zone in 1/100 mm

Example

```
// BARCODE (1/100 mm)
(SOH)AM[1]4498;7076;0;31;2;3000;12;4;0;1;3(ETB)
(SOH)AC[1]BT=2;BW=150;QZ=600(ETB)
(SOH)BM[1]1234567890123(ETB)
```



2D bar codes

PDF417

AM[n;y;x;p;a;d;s;rw;rh;ec;z;dp;c;r	
A	identification for mask set
M	identification for protocol version
n	field number
y	Y position in 1/100 mm
x	X position in 1/100 mm
p	identification for phantom field 0 = print 1 = no print
a	identification for field type 50 = PDF417
d	rotation 0 = 0° 1 = 90° 2 = 180° 3 = 270°
s	symbol size
rw	relation width
rh	relation height
ec	error correction level 0 - ECC Level = 0 1 - ECC Level = 2 2 - ECC Level = 6 3 - ECC Level = 14 4 - ECC Level = 30 5 - ECC Level = 62 6 - ECC Level = 126 7 - ECC Level = 254 8 - ECC Level = 510
z	style 0 = Standard 1 = Truncated 2 = Naked 3 = Bare
dp	datapoint 1 = left top 2 = centre top 3 = right top 4 = left centre 5 = centre centre 6 = right centre 7 = left bottom (default) 8 = centre bottom 9 = right bottom
c	number of columns 0 = automatic, 1-30
r	number of rows 0 = automatic, 3-90

MAXICODE

AM[n]y;x;p;a;d;0;sn;ns;m;0;dp	
A	identification for mask set
M	identification for protocol version
n	field number
y	Y position in 1/100 mm
x	X position in 1/100 mm
p	identification for phantom field 0 = print 1 = no print
a	identification for field type 51 = MAXICODE
d	rotation 0 = 0° 1 = 90° 2 = 180° 3 = 270°
0	dummy
sn	symbol number
ns	quantity of symbols
m	mode 2 = Structured Message (US Carrier) 3 = Structured Message (International Carrier) 4 = Default message
0	dummy
dp	datumpoint 1 = left top 2 = centre top 3 = right top 4 = left centre 5 = centre centre 6 = right centre 7 = left bottom (default) 8 = centre bottom 9 = right bottom

DataMatrix

AM[n;y;x;p;a;d;s;aw;ah;ec;f;dp																															
A	identification for mask set																														
M	identification for phantom field																														
n	field number																														
y	Y position in 1/100 mm																														
x	X position in 1/100 mm																														
p	identification for phantom field 0 = print; 1 = no print																														
a	identification for field type 52 = DataMatrix																														
d	rotation 0 = 0° 1 = 90° 2 = 180° 3 = 270°																														
s	symbol size in 1/100 mm																														
aw	relation width																														
ah	relation height																														
ec	error correction <table border="0"> <tr> <td>0 - ECC Type = 0</td> <td>ECC Level = 0</td> <td>Overhead = 0 %</td> </tr> <tr> <td>1 - ECC Type = 2*</td> <td>ECC Level = 40</td> <td>Overhead = 33 %</td> </tr> <tr> <td>2 - ECC Type = 3</td> <td>ECC Level = 50</td> <td>Overhead = 25 %</td> </tr> <tr> <td>3 - ECC Type = 6</td> <td>ECC Level = 80</td> <td>Overhead = 33 %</td> </tr> <tr> <td>4 - ECC Type = 8</td> <td>ECC Level = 100</td> <td>Overhead = 50 %</td> </tr> <tr> <td>5 - ECC Type = 9*</td> <td>ECC Level = 110</td> <td>Overhead = 75 %</td> </tr> <tr> <td>6 - ECC Type = 10*</td> <td>ECC Level = 120</td> <td>Overhead = 50 %</td> </tr> <tr> <td>7 - ECC Type = 11*</td> <td>ECC Level = 130</td> <td>Overhead = 67 %</td> </tr> <tr> <td>8 - ECC Type = 12</td> <td>ECC Level = 140</td> <td>Overhead = 75 %</td> </tr> <tr> <td>9 - ECC Type = 26</td> <td>ECC Level = 200</td> <td>Overhead = 0 %</td> </tr> </table>	0 - ECC Type = 0	ECC Level = 0	Overhead = 0 %	1 - ECC Type = 2*	ECC Level = 40	Overhead = 33 %	2 - ECC Type = 3	ECC Level = 50	Overhead = 25 %	3 - ECC Type = 6	ECC Level = 80	Overhead = 33 %	4 - ECC Type = 8	ECC Level = 100	Overhead = 50 %	5 - ECC Type = 9*	ECC Level = 110	Overhead = 75 %	6 - ECC Type = 10*	ECC Level = 120	Overhead = 50 %	7 - ECC Type = 11*	ECC Level = 130	Overhead = 67 %	8 - ECC Type = 12	ECC Level = 140	Overhead = 75 %	9 - ECC Type = 26	ECC Level = 200	Overhead = 0 %
0 - ECC Type = 0	ECC Level = 0	Overhead = 0 %																													
1 - ECC Type = 2*	ECC Level = 40	Overhead = 33 %																													
2 - ECC Type = 3	ECC Level = 50	Overhead = 25 %																													
3 - ECC Type = 6	ECC Level = 80	Overhead = 33 %																													
4 - ECC Type = 8	ECC Level = 100	Overhead = 50 %																													
5 - ECC Type = 9*	ECC Level = 110	Overhead = 75 %																													
6 - ECC Type = 10*	ECC Level = 120	Overhead = 50 %																													
7 - ECC Type = 11*	ECC Level = 130	Overhead = 67 %																													
8 - ECC Type = 12	ECC Level = 140	Overhead = 75 %																													
9 - ECC Type = 26	ECC Level = 200	Overhead = 0 %																													
f	format ID 0 - Format ID = 11 (numeric, 2000 characters)* 1 - Format ID = 1 (numeric, 500 characters) 2 - Format ID = 2 (alphabetical, 500 characters) 3 - Format ID = 3 (alphabetical + pointers, 500 characters) 4 - Format ID = 4 (alphanumeric, 500 characters) 5 - Format ID = 5 (7 Bit, 500 characters) 6 - Format ID = 6 (8 Bit, 500 characters) 7 - Format ID = 7 (pre-programmed, 500 characters)* 8 - Format ID = 12 (alphabetical, 2000 characters) 9 - Format ID = 14 (alphanumeric, 2000 characters)																														
dp	datumpoint 1 = left top 2 = centre top 3 = right top 4 = left centre 5 = centre centre 6 = right centre 7 = left bottom (default) 8 = centre bottom 9 = right bottom																														

* not supported from printer

GS1 DataMatrix

AM[n]y;x;p;a;d;s;aw;ah;ec;f;dp																															
A	identification for mask set																														
M	identification for phantom field																														
n	field number																														
y	Y position in 1/100 mm																														
x	X position in 1/100 mm																														
p	identification for phantom field 0 = print; 1 = no print																														
a	identification for field type 59 = GS1 DataMatrix																														
d	rotation 0 = 0° 1 = 90° 2 = 180° 3 = 270°																														
s	symbol size in 1/100 mm																														
aw	relation width																														
ah	relation height																														
ec	error correction <table border="0"> <tr> <td>0 - ECC Type = 0</td> <td>ECC Level = 0</td> <td>Overhead = 0 %</td> </tr> <tr> <td>1 - ECC Type = 2*</td> <td>ECC Level = 40</td> <td>Overhead = 33 %</td> </tr> <tr> <td>2 - ECC Type = 3</td> <td>ECC Level = 50</td> <td>Overhead = 25 %</td> </tr> <tr> <td>3 - ECC Type = 6</td> <td>ECC Level = 80</td> <td>Overhead = 33 %</td> </tr> <tr> <td>4 - ECC Type = 8</td> <td>ECC Level = 100</td> <td>Overhead = 50 %</td> </tr> <tr> <td>5 - ECC Type = 9*</td> <td>ECC Level = 110</td> <td>Overhead = 75 %</td> </tr> <tr> <td>6 - ECC Type = 10*</td> <td>ECC Level = 120</td> <td>Overhead = 50 %</td> </tr> <tr> <td>7 - ECC Type = 11*</td> <td>ECC Level = 130</td> <td>Overhead = 67 %</td> </tr> <tr> <td>8 - ECC Type = 12</td> <td>ECC Level = 140</td> <td>Overhead = 75 %</td> </tr> <tr> <td>9 - ECC Type = 26</td> <td>ECC Level = 200</td> <td>Overhead = 0 %</td> </tr> </table>	0 - ECC Type = 0	ECC Level = 0	Overhead = 0 %	1 - ECC Type = 2*	ECC Level = 40	Overhead = 33 %	2 - ECC Type = 3	ECC Level = 50	Overhead = 25 %	3 - ECC Type = 6	ECC Level = 80	Overhead = 33 %	4 - ECC Type = 8	ECC Level = 100	Overhead = 50 %	5 - ECC Type = 9*	ECC Level = 110	Overhead = 75 %	6 - ECC Type = 10*	ECC Level = 120	Overhead = 50 %	7 - ECC Type = 11*	ECC Level = 130	Overhead = 67 %	8 - ECC Type = 12	ECC Level = 140	Overhead = 75 %	9 - ECC Type = 26	ECC Level = 200	Overhead = 0 %
0 - ECC Type = 0	ECC Level = 0	Overhead = 0 %																													
1 - ECC Type = 2*	ECC Level = 40	Overhead = 33 %																													
2 - ECC Type = 3	ECC Level = 50	Overhead = 25 %																													
3 - ECC Type = 6	ECC Level = 80	Overhead = 33 %																													
4 - ECC Type = 8	ECC Level = 100	Overhead = 50 %																													
5 - ECC Type = 9*	ECC Level = 110	Overhead = 75 %																													
6 - ECC Type = 10*	ECC Level = 120	Overhead = 50 %																													
7 - ECC Type = 11*	ECC Level = 130	Overhead = 67 %																													
8 - ECC Type = 12	ECC Level = 140	Overhead = 75 %																													
9 - ECC Type = 26	ECC Level = 200	Overhead = 0 %																													
f	format ID 0 - Format ID = 11 (numeric, 2000 characters)* 1 - Format ID = 1 (numeric, 500 characters) 2 - Format ID = 2 (alphabetical, 500 characters) 3 - Format ID = 3 (alphabetical + pointers, 500 characters) 4 - Format ID = 4 (alphanumeric, 500 characters) 5 - Format ID = 5 (7 Bit, 500 characters) 6 - Format ID = 6 (8 Bit, 500 characters) 7 - Format ID = 7 (pre-programmed, 500 characters)* 8 - Format ID = 12 (alphabetical, 2000 characters) 9 - Format ID = 14 (alphanumeric, 2000 characters)																														
dp	datumpoint 1 = left top 2 = centre top 3 = right top 4 = left centre 5 = centre centre 6 = right centre 7 = left bottom (default) 8 = centre bottom 9 = right bottom																														

* not supported from printer

CODABLOCK F

AM[n]y;x;p;a;d;h;nc;nl;m;s;dp	
A	identification for mask set
M	identification for protocol version
n	field number
y	Y position in 1/100 mm
x	X position in 1/100 mm
p	identification for phantom field 0 = print 1 = no print
a	identification for field type 53 = CODABLOCK F
d	rotation 0 = 0° 1 = 90° 2 = 180° 3 = 270°
h	height of line in symbole
nc	quantity of characters/line
nl	quantity of lines
m	mode
s	module size
dp	datapoint 1 = left top 2 = centre top 3 = right top 4 = left centre 5 = centre centre 6 = right centre 7 = left bottom (default) 8 = centre bottom 9 = right bottom

GS1 DataBar (RSS)

AM[n]y;x;p;a;d;s;m;k;t;0;dp	
A	identification for mask set
M	identification for protocol version
n	field number
y	Y position in 1/100 mm
x	X position in 1/100 mm
p	identification for phantom field 0 = print 1 = no print
a	identification for field type 54 = GS1 DataBar (RSS)
d	rotation 0 = 0° 1 = 90° 2 = 180° 3 = 270°
s	number of segments per line [2...22]
m	module width [1 ... 12]
k	spacing correction [0,1,2]
t	symbol type 1 = GS1 DataBar Omnidirectional (RSS-14) 2 = GS1 DataBar Truncated (RSS-14 Truncated) 3 = GS1 DataBar Stacked (RSS-14 Stacked) 4 = GS1 DataBar Stacked Omnidirectional (RSS-14 Stacked Omnidirectional) 5 = GS1 DataBar Limited (RSS Limited) 6 = GS1 DataBar Expanded (RSS Expanded)
z	not in use
dp	datapoint 1 = left top 2 = centre top 3 = right top 4 = left centre 5 = centre centre 6 = right centre 7 = left bottom (default) 8 = centre bottom 9 = right bottom

QR Code

AM[n];y;x;p;a;d;mo;cs;ms;cw;ec;dp	
A	identification for mask set
M	identification for protocol version
n	field number
y	Y position in 1/100 mm
x	X position in 1/100 mm
p	identification for phantom field 0 = print 1 = no print
a	identification for field type 57 = QR Code
d	rotation 0 = 0° 1 = 90° 2 = 180° 3 = 270°
mo	code model 1 = code model 1 2 = code model 2
cs	character set N = numeric A = alphanumeric B = 8-bit Byte K = Kanji
ms	masking -1 = auto 0-7 = mask x 8 = no masking
cw	line width in 1/100 mm per module possible values: 0-800
ec	error correction (restoring capacity) L = 7% M = 15% Q = 25% H = 30%
dp	datapoint 1 = left top 2 = centre top 3 = right top 4 = left centre 5 = centre centre 6 = right centre 7 = left bottom (default) 8 = centre bottom 9 = right bottom

Aztec Code

AM[n]y;x;p;a;d;mo;cs;ms;cw;ec;dp	
A	identification for mask set
M	identification for protocol version
n	field number
y	Y position in 1/100 mm
x	X position in 1/100 mm
p	identification for phantom field 0 = print 1 = no print
a	identification for field type 61 = Aztec Code
d	rotation 0 = 0° 1 = 90° 2 = 180° 3 = 270°
h	symbol size in 1/100 mm (max 1 cm)
f	format 0 = Auto 1 = C15xC15 Compact 2 = C19xC19 Compact 3 = C23xC23 Compact 4 = C27xC27 Compact 5 = C19xC19 6 = C23xC23 7 = C27xC27 8 = C31xC31 9 = C37xC37 10 = C41xC41 11 = C45xC45 12 = C49xC49 13 = C53xC53 14 = C57xC57 15 = C61xC61 16 = C67xC67 17 = C71xC71 18 = C75xC75 19 = C79xC79 20 = C83xC83 21 = C87xC87 22 = C91xC91 23 = C95xC95 24 = C101xC101 25 = C105xC105 26 = C109xC109 27 = C113xC113 28 = C117xC117 29 = C121xC121 30 = C125xC125 31 = C131xC131 32 = C135xC135 33 = C139xC139 34 = C143xC143 35 = C147xC147 36 = C151xC151
ec	error correction (only if format = 0) 1 = 10% 2 = 23% 3 = 36% 4 = 50%
m	mode 0 = data 1 = runes (figures 0-255) 2 = Unicode (8 Bit ASCII) 3 = GS1 (not yet available)
0	dummy
dp	datum point 1 = left top 2 = centre top 3 = right top 4 = left centre 5 = centre centre 6 = right centre 7 = left bottom (default) 8 = centre bottom 9 = right bottom

Rectangle

AM[n]y;x;p;a;h;b;s;m;dp	
A	identification for mask set
M	identification for protocol number
n	field number
y	Y position in 1/100 mm
x	X position in 1/100 mm
p	identification for phantom field 0 = print 1 = no print
a	identification for field type 10 = rectangle
h	height of rectangle in 1/100 mm
b	width of rectangle in 1/100 mm
s	line width in 1/100 mm
m	line style; 1 digit
dp	Datumpoint 1 = left top 2 = centre top 3 = right top 4 = left centre 5 = centre centre 6 = right centre 7 = left bottom (default) 8 = centre bottom 9 = right bottom

Line

AM[n]y;x;p;a;d;l;s;m;dp	
A	identification for mask set
M	identification for protocol version
n	field number
y	Y position in 1/100 mm
x	X position in 1/100 mm
p	identification for phantom field 0 = print 1 = no print
a	identification for field type 11 = line
d	rotation 0 = horizontal 1 = vertical
l	length in 1/100 mm
s	line width in 1/100 mm
m	line style, 1 digit
dp	datumpoint 1 = left top 2 = centre top 3 = right top 4 = left centre 5 = centre centre 6 = right centre 7 = left bottom (default) 8 = centre bottom 9 = right bottom

Internal graphic

AM[n]y;x;p;a;d;dy;dx;dp	
A	identification for mask set
M	identification for protocol version
n	field number
y	Y position in 1/100 mm
x	X position in 1/100 mm
p	identification for phantom field 0 = print 1 = no print
a	identification for field type 3 = internal graphic
d	rotation 0 = 0° 1 = 90° 2 = 180° 3 = 270°
dy	extension in direction Y
dx	extension in direction X
dp	datumpoint 1 = left top 2 = centre top 3 = right top 4 = left centre 5 = centre centre 6 = right centre 7 = left bottom (default) 8 = centre bottom 9 = right bottom

TEXT SET

BM[n]text	
B	identification for text set
M	identification for extended protocol
n	field number
text	data contents, text

BV[n]text	
B	identification for text set
V	identification for selection by field name
n	field name
text	data contents, text

BF[n]text	
B	identification for text set
F	identification for selection by free definable field number
n	field number
text	data contents, text

Examples

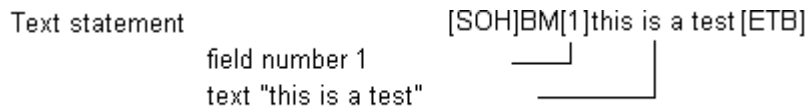
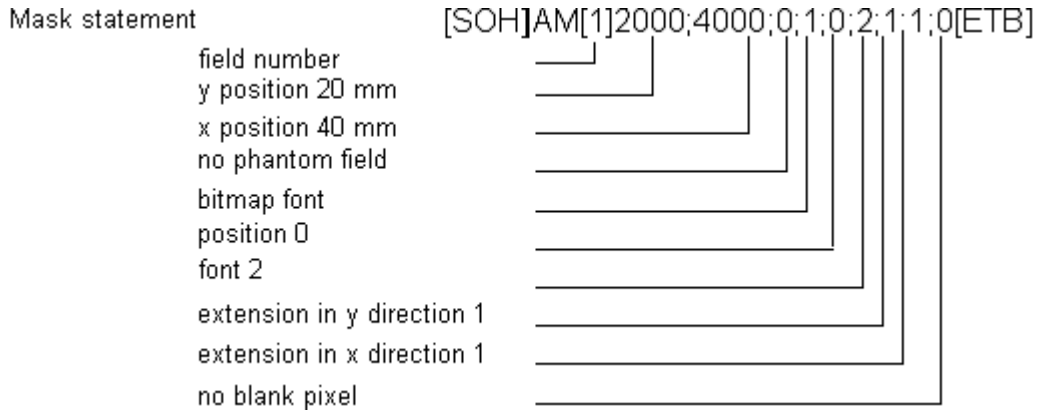

text set with variable definition: [SOH]BM[125]=CN(0,0,3,1,1)000[ETB]

Example layout

ASCII data	Identification
⊗AM[1]3600;4600;0;33;0;1500;0;4;1;1⊕ ^C _R ^L _F	mask set for bar code
⊗BM[1]444444444444⊕ ^C _R ^L _F	appropriate text set
⊗AM[2]600;4700;0;4;0;1;300;200;24⊕ ^C _R ^L _F	five mask sets vector font / proportional font
⊗AM[3]600;3100;0;4;0;1;400;300;24⊕ ^C _R ^L _F	
⊗AM[4]1100;4700;0;4;0;1;400;300;24⊕ ^C _R ^L _F	
⊗AM[5]1800;4700;0;4;0;1;300;200;24⊕ ^C _R ^L _F	
⊗AM[6]1900;3700;0;4;0;1;600;400;24⊕ ^C _R ^L _F	
⊗BM[2]Art.Nr. ⊕ ^C _R ^L _F	five appropriate text sets
⊗BM[3]44444⊕ ^C _R ^L _F	
⊗BM[4]Artikelbezeichnung⊕ ^C _R ^L _F	
⊗BM[5]DM⊕ ^C _R ^L _F	
⊗BM[6]99,-- ⊕ ^C _R ^L _F	
⊗FBA000r06000000⊕	number of lines
⊗FBBA00r00001000⊕	number of items
⊗FBC000r00000000⊕	start

- # : graphic data in PCX format
 ⊗: SOH (1_{hex} bzw 5E_{hex})
 ⊕: ETB (17_{hex} bzw. 5F_{hex})
^C: CarriageReturn (0D_{hex})
^L_F: LineFeed (0A_{hex})

GRAPHIC

General graphic format

This format is supported by all our print modules but note that a 8 bit transmission is absolute necessary.

SOH	D	p	p	p	p	lb	lb	lb	b	b	b	gb.....	ETB
-----	---	---	---	---	---	----	----	----	---	---	---	------------------	-----

			min.	max.
D	=	identification for graphic set		
p	=	pixel line from above	'0000'	'1900'
lb	=	1. byte from left	'000'	'100'
b	=	quantity of bytes	'1'	'100'
gb	=	graphic bytes		

Graphic byte:



1 graphic bit = 0,083 x 0,083 mm

Graphic in PCX format

It is possible to transfer graphic data as a PCX-file (e.g. PaintBrush) to the print module. With this type of data transfer the PCX-file is transferred in a compressed form. Hereby the RLE-procedure is used and therefore the graphic data were reduced by approx. 30 %. This means that the effective transferring time for 300 dpi print modules is cut in halves.

To set the print module ready for receiving PCX-data the protocol has to be switched over and hereby the following command set will be defined:

SOH	A	X	n	n	n	y	y	y	y	y	x	x	x	x	x	x	m	dp	ETB
-----	---	---	---	---	---	---	---	---	---	---	---	---	---	---	---	---	---	----	-----

n	Index of transferred graphic to print module internal maintenance at present not processed (000)		
y	Y coordinate of graphic in 1/100 mm		
x	X coordinate of graphic in 1/100 mm		
m	Mode 0 = standard	-	background is overwritten
	Mode 1 = transparency	-	background is maintained
	Mode 2 = inverse	-	background is overwritten
	Mode 3 = inverse transparency	-	background is maintained
dp	Datumpoint		
	1 = left top	2 = centre top	3 = right top
	4 = left centre	5 = centre centre	6 = right centre
	7 = left bottom (default)	8 = centre bottom	9 = right bottom

- It is recommended to observe that directly after the final sign (ETB) no separator res. fill character such as $C_R^L F$ is indicated.
- The print module supports the following PCX versions: 5, 3, 2 and 0.
- It is necessary that the corresponding PCX-file is available as monochrome (black/white).
- The graphic has to be available in the original size as the print module is not able to change the size by itself.

Before print start, indicated by parameter set 'FBC', the definition of field number, lines and pieces has to be effected via the parameter sets (FBA res. FBB).

Example of PCX file

-*** PCX_GRAPHIC-INFO ***-	
⊗AX0010015300100941⊕#####	
⊗AM[1]3600;4600;0;33;0;1500;0;4;1;1⊕ ^C _R ^L _F	mask set for bar code
⊗BM[1]444444444444⊕ ^C _R ^L _F	appropriate text set
⊗AM[2]600;4700;0;4;0;1;300;200;24⊕ ^C _R ^L _F ⊗AM[3]600;3100;0;4;0;1;400;300;24⊕ ^C _R ^L _F ⊗AM[4]1100;4700;0;4;0;1;400;300;24⊕ ^C _R ^L _F ⊗AM[5]1800;4700;0;4;0;1;300;200;24⊕ ^C _R ^L _F ⊗AM[6]1900;3700;0;4;0;1;600;400;24⊕ ^C _R ^L _F	five mask set vector font / proportional font
⊗BM[2]Art.Nr. ⊕ ^C _R ^L _F ⊗BM[3]44444⊕ ^C _R ^L _F ⊗BM[4]Artikelbezeichnung⊕ ^C _R ^L _F ⊗BM[5]DM⊕ ^C _R ^L _F ⊗BM[6]99,-- ⊕ ^C _R ^L _F	Five appropriate text sets
⊗FBA00r06000000⊕	set number of lines (FBA...)
⊗FBBA00r00001000⊕	set quantity (FBBA...)
⊗FBC000r00000000⊕	start print order (FBC...)

: graphic data in PCX format

⊗: SOH (1_{hex} bzw 5E_{hex})

⊕: ETB (17_{hex} bzw. 5F_{hex})

^C_R: CarriageReturn (0D_{hex})

^L_F: LineFeed (0A_{hex})

VARIABLES

Set structure

SOH	BM	[n]	=	v	v	(p1	p2	p	pn)	t1	t2	t	t70	ETB
-----	----	-----	---	---	---	---	----	----	---	----	---	----	----	---	-----	-----

The grey marked part corresponds to the variable definition. The text entered from t1 to t70 is added to the function result of variable.

= start of function

vv variable type
 SC link field
 CN counter
 CC extended counter
 CL date/time
 CU currency variable
 SH shift variable
 UG user guiding
 MD memory card data

(start of variable parameter block

p1...pn variable parameter

) end of variable parameter block

Note: In case you want to print a text which corresponds exactly to the variable definition then you have to place '!' before.

SOH	BM	[n]	!	=	v	v	(p1	p2	p	pn)	t1	t2	t	t70	ETB
-----	----	-----	---	---	---	---	---	----	----	---	----	---	----	----	---	-----	-----

Link field

SOH	BM	[n]	=	S	C	(p1	;	p2	;	p	;	pn)	t1	t2	t	t70	ETB
-----	----	-----	---	---	---	---	----	---	----	---	---	---	----	---	----	----	---	-----	-----

= SC identification of link field

p1...pn identification of link elements (field number or constant text)
 field number is entered without leading '0'
 constant text is included in " but these marks are not printed

Note: Reference fields can be constant text or variables but no link fields.

Example: = SC (1; 2; 3) print: field1field2field3
 = SC (1;"constant"; 2) print: field1constantfield2

Counter

SOH	BM	[n]	=	C	N	(t	;	m	;	c	;	+/-	s	;	i	;	h	;	r)	t1	t2	t	t70	ETB
																							...			

= CN identification counter

t type of counter
 0 numerical
 1 letters only
 2...36 radix, base of the counter

m function mode of counter
 0 standard
 1 return to start value
 2 enter the start value at the beginning of printing
 (default = existing start value)
 3 enter the start value at the beginning of printing
 (default = last final number)
 4 reset start value at cycle end
 (only for DPM IIIi)
 5 reset start value by I/O signal
 6 time-controlled resetting
 7 time-controlled resetting with input of initial value
 (default = last final value)

c digit where the numbering starts counting

+/- direction
 + adding
 - subtracting

s step width

i update interval
 (number of labels with identical number)

h time by which the counter is reset (function mode 6 and 7) in format 'HH:MM'
 e.g. 00:00 = reset counter at 0:00
 (optional, only for function mode 6 and 7)

r reset value
 (optional, only for function mode 6 and 7; default = text and/or initial value)

Limitation:

The time-controlled resetting of counter variable is only effected in case of an active print order. If a print order is cancelled before the specified time and afterwards again restarted then no resetting of counter value is effected.

t1, t2, ... text res. start value of counter

Example:

Entry: = CN (10;7;4;+1;1;06:00;0001)1234

The enquiry for the initial value is effected at print start and at 6:00 the counter variable is reset to value 0001.

Extended counter

SOH	BM	[n]	=	C	C	(+/-	s	;	i	;	m	;	z	;	n	;	x)	t	ETB
-----	----	-----	---	---	---	---	-----	---	---	---	---	---	---	---	---	---	---	---	---	---	-----

= CC	identification of numeric counter
+/-	direction
+	counter adding
-	counter subtracting
s	step width
i	update interval (number of labels with identical number)
m	function mode of counter
0	standard
1	return to start value
2	enter the start value at the beginning of printing (default = existing start value)
3	enter the start value at the beginning of printing (default = last final number)
4	reset start value at cycle end (only for DPM IIIi)
5	set min. / max. value
6	set start value
7	print end
z	leading zeros
0	no leading zeros
1	printout with leading zeros
n	minimum value (max. -999999999)
x	maximum value (max. 999999999)
t	start value (the number of digits determines the format for the printout with leading zeros (max. 999999999))

Example:

Entry: = CC (+1;2;5;0;1,999)0050

Print: 50, 51,...999, 1, 2, ...

Date / Time

SOH	BM	[n]	=	C	L	(m	;	d	;	i	;	n	;	c	;	mo	;	pd	;	pm	;	md	;	mm	;	rw	;	ws)	t1	t...	t70	ETB
-----	----	-----	---	---	---	---	---	---	---	---	---	---	---	---	---	---	----	---	----	---	----	---	----	---	----	---	----	---	----	---	----	------	-----	-----

= CL identification date/time
 m month offset to the actual date
 d day offset to the actual date
 i update interval (0 = at the beginning of a print order, 1 = each label)

Optional parameters

n minute offset to the actual time
 (negative entry/value possible)
 c correction month overflow (0 = change to the next month, 1 = remain in current month)

Optional parameters for BBE date

mo entry mode 0: standard; display current date of real time clock
 1: display calculated date, modification possible
 2: display calculated date, no modification possible
 pd max. positive correction days
 pm max. positive correction months
 md max. negative correction days
 mm max. negative correction months

Optional parameters for rounded date

rw rounded weekday: 1 = Sunday ... 7 = Saturday; 0 = no rounding
 ws start of week, format: "D-HH:MM", e.g. 1-00:00 = Sunday, 0:00 Uhr

Examples:

Actual date as per Real Time Clock: 25.02.08

Entry:	= CL (0;0;0)<DD.MO.YY>	Print:	25.02.08
Entry:	= CL (1;1;0)<DD.MO.YY>	Print:	26.03.08

Example for BBE date

Entry: =CL (0;0;0;0;0;1;3;2;3;2)<DD.MO.YY> At print start the calculated date is displayed at the printer and can be modified (+/- 3 days and +/- 2 months):

Display:

ID_01	DD:MO:YY
	25:02:08

Example for rounded date

The beginning of the week is on Sunday at 00:00. The date of Monday should be printed the whole week.

Entry: =CL (0;0;0;0;0;0;0;0;0;2;1-00:00)<DD.MO.YY>

Current date	Rounded date
23.02.2008 23:59:59	18.02.2008
24.02.2008 00:00:00	25.02.2008
25.02.2008	25.02.2008
01.03.2008 23:59:59	25.02.2008
02.03.2008 00:00:00	03.03.2008

Format identifier

Standard format	
HH	Hours 2-digit (24 hours)
HE	Hours 2-digit (12 hours)
MI	Minutes 2-digit
SS	Seconds 2-digit
AM	AM/PM output
DD	Day 2-digit
MO	Month 2-digit
YYYY	Year 4-digit
YY	Year 2-digit
Y	Year 1-digit
WW	Calendar week
DW	Day of week (Sunday = 0)
DW1	Day of week (Sunday = 1)
DwX	Day of week For x it is possible to enter any ASCII character from which is counted continuously
DOWxxxxxx	Day of week - variable For x it is possible to enter any ASCII character The first ,x' denominates Sunday, the next denominates Monday and so on until Saturday For each weekday a character must be created
DOY	Day of year 3-digit (First January = 1)
DY	Day of year 3-digit (First January = 0)
Examples	
DD.MO.YY	10.09.06
MO/DD/YYYY	09/10/2006
YY-MO-DD	06-09-10
YYMODD	060910

The format identifier 'HE' and 'AM'/'am'/'Am' are supplemented. Therefore the output of hours in 12-hours mode is possible. By the additional output of format identifier 'AM' the output of time in american/english format is possible.

Examples:

```
=CL(0;0;0;0)<HH:MI:SS>          ->    15:30:00
=CL(0;0;0;0)<HE:MI:SS>          ->    03:30:00
=CL(0;0;0;0)<HE:MI:SS AM>       ->    03:30:00 PM
=CL(0;0;0;0)<HE:MI:SS am>       ->    03:30:00 pm
=CL(0;0;0;0)<HE:MI:SS Am>       ->    03:30:00 p.m.
```

By separating the output of time and AM/PM output in 2 text fields, also the following output format is possible:

```
03:30:00 pm
```

Extended format	
XMO	Name of month short
XSO	Name of month long
XSD	Weekday short
XLD	Weekday long
For X you can enter the country identification of desired language	
C = Canadian D = Danish E = English F = French G = German I = Italian N = Dutch O = Norwegian S = Spanish U = Finnish W = Swedish	
Examples:	
DD.EMO.YY	10.SEP.06
DD.ESO YYYY	10. September 2006
ELD,DD.GMO.YY	Sunday, 10. SEP.06
ESD,DD.MO.YY	DO, 10.09.06

Extended format - XMO

C	JA	FE	MR	AL	MA	JN	JL	AU	SE	OC	NO	DE
D	JAN	FEB	MAR	APR	MAJ	JUN	JUL	AUG	SEP	OKT	NOV	DEC
E	JAN	FEB	MAR	APR	MAY	JUN	JUL	AUG	SEP	OCT	NOV	DEC
F	JAN	FEV	MAR	AVR	MAI	JUIN	JUIL	AOU	SEP	OCT	NOV	DEC
G	JAN	FEB	MRZ	APR	MAI	JUN	JUL	AUG	SEP	OKT	NOV	DEZ
I	GEN	FEB	MAR	APR	MAG	GIU	LUG	AGO	SET	OTT	NOV	DIC
N	JAN	FEB	MRT	APR	MEI	JUN	JUL	AUG	SEP	OKT	NOV	DEC
O	JAN	FEB	MAR	APR	MAI	JUN	JUL	AUG	SEP	OKT	NOV	DES
S	ENE	FEB	MAR	ABR	MAY	JUN	JUL	AGO	SEP	OCT	NOV	DIC
U	TAM	HEL	MAA	HUH	TOU	KES	HEI	ELO	SYU	LOK	MAR	JOU
W	JAN	FEB	MAR	APR	MAJ	JUN	JUL	AUG	SEP	OKT	NOV	DEC

Extended format - XSO

C	January	February	March	April	May	June
D	Januar	Februar	Marts	April	Maj	Juni
E	January	February	March	April	May	June
F	Janvier	Février	Mars	Avril	Mai	Juin
G	Januar	Februar	Maerz	April	Mai	Juni
I	Gennaio	Febbraio	Marzo	Aprile	Maggio	Giugno
N	Januari	Februari	Maart	April	Mei	Juni
O	Januar	Februar	Mars	April	Mai	Juni
S	Enero	Febrero	Marzo	Abril	Mayo	Junio
U	Tammikuu	Helmikuu	Maaliskuu	Huhtikuu	Toukokuu	Kesaekuu
W	Januari	Februari	Mars	April	Maj	Juni

C	July	August	September	October	November	December
D	Juli	August	September	Oktober	November	December
E	July	August	September	October	November	December
F	Juillet	Août	Septembre	Octobre	Novembre	Décembre
G	Juli	August	September	Oktober	November	Dezember
I	Luglio	Agosto	Settembre	Ottobre	Novembre	Dicembre
N	Juli	Augustus	September	Oktober	November	December
O	Juli	August	September	Oktober	November	Desember
S	Julio	Agosto	Septiembre	Octubre	Noviembre	Diciembre
U	Heinaekuu	Elokuu	Syyskuu	Lokakuu	Marraksuu	Joulukuu
W	Juli	Augusti	September	Oktober	November	December

Extended format - XSD

C	SUN	MON	TUE	WED	THU	FRI	SAT
D	SO	MA	TI	ON	TO	FR	LO
E	SUN	MON	TUE	WED	THU	FRI	SAT
F	DIM	LUN	MAR	MER	JEU	VEN	SAM
G	SO	MO	DI	MI	DO	FR	SA
I	DOM	LUN	MAR	MER	GIO	VEN	SAB
N	ZO	MA	DI	WO	DO	VR	ZA
O	SO	MA	TI	ON	TO	FR	LO
S	DOM	LUN	MAR	MIE	JUE	VIE	SAB
U	SU	MA	TI	KE	TO	PE	LA
W	SO	LA	TI	ON	TO	FR	LO

Extended format - XLD

C	Sunday	Monday	Tuesday	Wednesday	Thursday	Friday	Saturday
D	Søndag	Mandag	Tirsdag	Onsdag	Torsdag	Fredag	Lørdag
E	Sunday	Monday	Tuesday	Wednesday	Thursday	Friday	Saturday
F	Dimanche	Lundi	Mardi	Mercredi	Jeudi	Vendredi	Samedi
G	Sonntag	Montag	Dienstag	Mittwoch	Donnerstag	Freitag	Samstag
I	Domenica	Lunedì	Martedì	Mercoledì	Giovedì	Venerdì	Sabato
N	Zondag	Maandag	Dinsdag	Woensdag	Donderdag	Vrijdag	Zaterdag
O	Søndag	Mandag	Tirsdag	Onsdag	Torsdag	Fredag	Lørdag
S	Domingo	Lunes	Martes	Miércoles	Jueves	Viernes	Sábado
U	Sunnuntai	Maanantai	Tiistai	Keski-viikko	Torstai	Perjantai	Lauantai
W	Søndag	Måndag	Tisdag	Onsdag	Torsdag	Fredag	Lördag

Currency variable

SOH	B	n	n	=	C	U	(a	;	b	;	c	;	d	;	e	;	f	;	g)	t1	t2	t	t70	ETB
																							...			

- = CU Signification of variable Euro
- a ANSI-Code of thousand separator as decimal figure
- b ANSI-Code of comma separator as decimal figure
- c Quantity of numbers after the comma as decimal figure
- d Operand A Before the processing the variable Euro calculates the term
- e Operand B $\frac{A \times B}{C}$
- f Operand C
- g Rounding format
- t1, t2, ... Format string, is indicated by "< >"

Example:

In case the contents of field 20 has to be converted from USD into EUR the definition of variable for the user defined format is as follows:

B01 "=CU(46;44;2;20;"1,0";"0,68861";"0,01")Result: <>Euro"

B20 1.250,44 USD

Printout: 1.250,44 USD

 Result: 1.815,89 Euro *

* 1 USD = 0,68861 Euro (11.01.2010)

User guiding

SOH	BM	[n]	=	U	G	(c	;	t	;	m	;	ap	;	ae	;	sp)	t1	t2	t	t70	ETB
-----	----	-----	---	---	---	---	---	---	---	---	---	---	----	---	----	---	----	---	----	----	---	-----	-----

= UG identification user guiding

c start position for the entry

t type of entry
 0 numerical
 1 alphanumerical

m mode of entry
 0 do not jump over special characters
 1 jump over special characters

ap alignment print
 0 aligned to the right side

ae alignment entry
 0 aligned to the right

sp prompt text for the variable, max. 24 characters
 The entry has to be included in ".

Example:

Entry: = UG (1;0;0;0;0;"Enter article no")<000000>

Display:

```
Enter article no
000000
```

User guiding with mask

SOH	BM	[n]	=	U	M	(c	;	t	;	m	;	ap	;	ae	;	sp	;	d	;	ma)	t1	t2	t...	t70	ETB
-----	----	-----	---	---	---	---	---	---	---	---	---	---	----	---	----	---	----	---	---	---	----	---	----	----	------	-----	-----

= UM	identification user guiding with mask
c	start position for the entry
t	type of entry
0	numerical
1	alphanumeric
m	mode of entry
0	do not jump over special characters
1	jump over special characters
ap	alignment print
0	aligned to the right side
ae	alignment entry
0	aligned to the right
sp	prompt text for the variable, max. 24 characters The entry has to be included in ".
d	deleting setpoint value
0	setpoint value remains at key entry
1	with first key press the setpoint value disappears
ma	definition of mask
	possible mask characters are
9	numbers only
#	only numbers and leading signs
?	letters only
a	alphanumeric characters (letters and numbers)
C	any characters

Example:

Entry: = UM (1;0;0;0;0;"Enter article no." ;0;"999-aa")<123-xx>

Display:

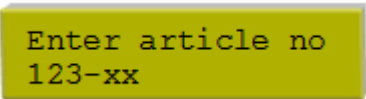

```
Enter article no
123-xx
```

Memory card data

SOH	BM	[n]	=	M	D	(FN="filename"	;	SE='x'	;	CH=x	;	SC="x"	;	SF="x"	;	RC="x")	ETB
-----	----	-----	---	---	---	---	---------------	---	--------	---	------	---	--------	---	--------	---	--------	---	-----

= MD identification of memory card data

FN file name of table onto memory card with CSV data

SE Separator sign (default = ';')

CH column name in the first line (0 = no, 1 = yes)

SC name and/or number of column that should be referenced

SF field name and/or field index of field onto the label, which contains the searched data

RC name and/or number of column, which contains the data to be printed

Remark: If in parameter SF a field name is indicated, this must have been defined for the appropriate field by an AC attribute statement!

Example:

AC[1]NAME="FCODE"

BM[2]=MD(FN="a:\daten.csv";SE=";";CH=1;SC="Farbcode";SF="FCODE";RC="IC-Nummer")

Field 1 Printout field Feld 2

00001 121478242

23252 784587448

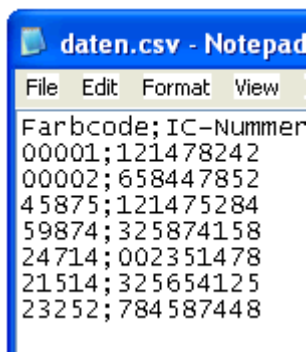

GS1-128 Parser

Note: By means of this variable type, the content of an application identifier in a GS1-128 bar code can be determined.

SOH	BM	[n]	=	A	I	(p	;	Ai)	ETB
-----	----	-----	---	---	---	---	---	---	----	---	-----

= AI identification of GS1-128 parser

p identification of the link element (field number)

Ai application identifier

Example: Field 1 ="00123456789012345675" GS1-128 with AI00

= AI (1;"00")

Printout: 123456789012345675

EPC calculation (Electronic Product Code)*

SOH BM [n] = E P C (M ; L ; F ; P ; N1 ; {N2}) ETB

= EPC identification of EPC calculation/Kennung EPC Berechnung

M coding method
 L length of manufacturer number (company prefix)
 F filter value
 P verification of check digit
 N1 identification of link element (field number)
 N2 identification of link element (field number) - optional

Note: For more information, visit the following web sites: www.epcglobalinc.org or www.gs1.org

Parameter	Value range		
M	0 = Coding method SSCC96		3 = Coding method GRAI96
	1 = Coding method SGTIN96		4 = Coding method GIAI96
	2 = Coding method SGLN96		
L	6...12		
F	Coding	Filter value	Binary value
	SSCC96	All Others	000
		Undefined	001
		Logistical / Shipping Unit	010
	SGTIN96	All Others	000
		Retail Consumer Trade Item	001
		Standard Trade Item Grouping	010
		Single Shipping / Consumer Trade Item	011
	SGLN	All Others	000
		Physical Location	001
	GRAI	All Others	000
	GIAI	All Others	000
P	0 = no verification; 1 = verification of check digit		
N1	any		
N2	any		

Example 1: Field 1 = "00123456789012345675" GS1-128 with AI00
 Field 2 = AI (1;"00") Printout: 123456789012345675
 Field 3 = EPC(0;12;0;1;2) Printout: 3100DA7557D32C38E7000000

The EPC is calculated with the content of Field 2. The coding method SSCC96 is used. In Field 2 a valid NVE must be represented (18-digit, correct check digit).

Example 2: Field 1 = "4141234567890128254123" GS1-128 with AI00, AI254
 Field 2 = AI (1;"414") Printout: 1234567890128
 Field 3 = AI (1;"254") Printout: 123
 Field 4 = EPC(2;10;0;0;2;3) Printout: 3208499602D218000000007B

The EPC is calculated with the content of Field 2 and Field 3. The coding method SGLN96 is used. In Field 2 a valid ILN must be represented (13-digit). In the example, Field 3 contains an optional serial number. No verification of check digit of ILN (8) is effected.

* only when using option RFID

Check digit

SOH	BM	[n]	=	C	D	(d	;	s	;	l	;	t	;	w	;	m	;	r	;	o)	t1	t...	t70	ETB
-----	----	-----	---	---	---	---	---	---	---	---	---	---	---	---	---	---	---	---	---	---	---	---	----	------	-----	-----

- = CD Identification of check digit
- d Data for check digit calculation (field number of constant text)
Constant text is enclosed in "".
- s Start position within data
1 ...n Start calculation at digit x
- l Check digit type
- | | |
|---|--------------------------|
| 0 | Modulo 10 (weighting 3) |
| 1 | Modulo 11 |
| 2 | Modulo 43 |
| 3 | Modulo 47 (weighting 15) |
| 4 | Modulo 47 (weighting 20) |
| 5 | Modulo 103 |
| 6 | Benutzerdefiniert |

Optional parameters for customized check digit

- w Weighting.
Constant text enclosed in "" - contains the individual weighting values or an interval.
Individual values: "x₁,x₂"
Interval: "x₁...x₂"
- m Modulo
- r Add result to
- o Print only one digit
- | | |
|---|-----|
| 0 | No |
| 1 | Yes |

Example: Entry: =CD("123456789012";0;0;0)
Printout: 8

Entry: =CD("1234567890";0;0;6;"1,3";10;10;1)
Printout: 5

Substring

SOH	BM	[n]	=	S	S	(d	;	s	;	l)	ETB
-----	----	-----	---	---	---	---	---	---	---	---	---	---	-----

- = SS Identification of substring
- d Data used for substring extraction (field number or field name or constant text.
Constant text is enclosed in "".
- s Start position within data. If this parameter is omitted, the substring extraction starts with the 1st character of the data string.
1 n Start at digit x
- l Number of digits. If this parameter is omitted, all characters from the start position to the end of the data string are returned.
1 ...n At the start position x digits

Example:

Entry:	=SS("1234567890";4;3)
Printout:	456
	Field "ARTIKELNR" has the contents "370012330295"
Entry:	=SS(ARTIKELNR;1;4)
Printout:	3700

PARAMETER SETS

Layout parameters

Set layout length in 1/100 mm

SOH	F	C	C	L	-	-	r	N	N	N	N	N	N	N	-	ETB
-----	---	---	---	---	---	---	---	---	---	---	---	---	---	---	---	-----

N: value of layout length in 1/100 mm, 7 digit ASCII number

Enquire layout length in 1/100 mm

SOH	F	C	C	L	-	-	w	N	N	N	N	N	N	N	-	ETB
-----	---	---	---	---	---	---	---	---	---	---	---	---	---	---	---	-----

Answer

SOH	A	N	N	N	N	N	N	N	-	p	p	p	p	p	p	p	ETB
-----	---	---	---	---	---	---	---	---	---	---	---	---	---	---	---	---	-----

Set layout width in 1/100 mm

SOH	F	C	C	O	-	-	r	N	N	N	N	N	N	N	ETB
-----	---	---	---	---	---	---	---	---	---	---	---	---	---	---	-----

N: indication of layout width in 1/100 mm, 7 digit ASCII number

Enquire layout width in 1/100 mm

SOH	F	C	C	O	-	-	w	P	P	P	P	P	P	P	P	ETB
-----	---	---	---	---	---	---	---	---	---	---	---	---	---	---	---	-----

Answer

SOH	A	N	N	N	N	N	N	N	-	p	p	p	p	p	p	p	ETB
-----	---	---	---	---	---	---	---	---	---	---	---	---	---	---	---	---	-----

Set displacement in direction X (Offset 3)

SOH	F	C	C	E	-	-	r	V	N	N	N	-	-	-	-	ETB
-----	---	---	---	---	---	---	---	---	---	---	---	---	---	---	---	-----

V: pre-sign of offset (+ or -)

NNN: offset value, 3 digit ASCII number in 1/10 mm

Enquire displacement in direction X (Offset 3)

SOH	F	C	C	E	-	-	w	p	p	p	p	p	p	p	p	ETB
-----	---	---	---	---	---	---	---	---	---	---	---	---	---	---	---	-----

Answer

SOH	A	V	N	N	N	-	-	-	-	p	p	p	p	p	p	p	ETB
-----	---	---	---	---	---	---	---	---	---	---	---	---	---	---	---	---	-----

Set layouts per cycle

SOH	F	C	A	D	I	-	r	N	N	-	-	-	-	-	-	ETB
-----	---	---	---	---	---	---	---	---	---	---	---	---	---	---	---	-----

NN: number of layouts per cycle (01...25)

Enquire layouts per cycle

SOH	F	C	A	D	I	-	w	p	p	p	p	p	p	p	p	ETB
-----	---	---	---	---	---	---	---	---	---	---	---	---	---	---	---	-----

Answer

SOH	A	N	N	-	-	-	-	-	-	p	p	p	p	p	p	p	ETB
-----	---	---	---	---	---	---	---	---	---	---	---	---	---	---	---	---	-----

NN: current layouts per cycle

Set layout alignment

SOH	F	C	C	J	-	-	r	N	-	-	-	-	-	-	-	-	ETB
-----	---	---	---	---	---	---	---	---	---	---	---	---	---	---	---	---	-----

N = 0: left

N = 1: centre

N = 2: right

Enquire layout alignment

SOH	F	C	C	J	-	-	w	p	p	p	p	p	p	p	p	p	ETB
-----	---	---	---	---	---	---	---	---	---	---	---	---	---	---	---	---	-----

Answer

SOH	A	N	-	-	-	-	-	-	-	p	p	p	p	p	p	p	ETB
-----	---	---	---	---	---	---	---	---	---	---	---	---	---	---	---	---	-----

Set contrast

SOH	F	C	A	B	-	-	r	N	N	N	-	-	-	-	-	ETB
-----	---	---	---	---	---	---	---	---	---	---	---	---	---	---	---	-----

NNN: Indication of contrast in % (010...200)

It is necessary to transmit a 3 digit ASCII number

Enquire contrast

SOH	F	C	A	B	-	-	w	p	p	p	p	p	p	p	p	ETB
-----	---	---	---	---	---	---	---	---	---	---	---	---	---	---	---	-----

Answer

SOH	A	N	N	N	-	-	-	-	-	p	p	p	p	p	p	p	ETB
-----	---	---	---	---	---	---	---	---	---	---	---	---	---	---	---	---	-----

Set material

SOH	F	C	D	N	C	-	r	N	N	N	N	-	-	-	-	ETB
-----	---	---	---	---	---	---	---	---	---	---	---	---	---	---	---	-----

NNNN: indication of material

Type 1: paper

Type 2: foil

Enquire material

SOH	F	C	D	N	C	-	w	p	p	p	p	p	p	p	p	ETB
-----	---	---	---	---	---	---	---	---	---	---	---	---	---	---	---	-----

Answer

SOH	A	N	N	N	N	-	-	-	-	p	p	p	p	p	p	p	ETB
-----	---	---	---	---	---	---	---	---	---	---	---	---	---	---	---	---	-----

Set number of columns

SOH	F	C	C	H	A	-	r	N	-	-	-	-	-	-	-	ETB
-----	---	---	---	---	---	---	---	---	---	---	---	---	---	---	---	-----

N = number of columns (1...9)

Enquire number of columns

SOH	F	C	C	H	A	-	w	p	p	p	p	p	p	p	p	ETB
-----	---	---	---	---	---	---	---	---	---	---	---	---	---	---	---	-----

Answer

SOH	A	N	-	-	-	-	-	-	-	p	p	p	p	p	p	p	ETB
-----	---	---	---	---	---	---	---	---	---	---	---	---	---	---	---	---	-----

Set column width

SOH	F	C	C	H	B	-	r	N	N	N	-	-	-	-	-	ETB
-----	---	---	---	---	---	---	---	---	---	---	---	---	---	---	---	-----

NNN: indication of column width in 1/10 mm (0...999)

Enquire column width

SOH	F	C	C	H	B	-	w	p	p	p	p	p	p	p	p	ETB
-----	---	---	---	---	---	---	---	---	---	---	---	---	---	---	---	-----

Answer

SOH	A	N	N	N	-	-	-	-	-	p	p	p	p	p	p	p	ETB
-----	---	---	---	---	---	---	---	---	---	---	---	---	---	---	---	---	-----

Set line number of layout (n digits)

SOH	F	B	A	A	-	-	r	N	ETB
-----	---	---	---	---	---	---	---	---	-----

N: Indication of line number in ASCII (1, 10, 100, ...)

Enquire line number of layout

SOH	F	B	A	A	-	-	w	p	p	p	p	p	p	p	p	ETB
-----	---	---	---	---	---	---	---	---	---	---	---	---	---	---	---	-----

Answer

SOH	A	N	-	-	-	-	-	-	-	p	p	p	p	p	p	p	ETB
-----	---	---	---	---	---	---	---	---	---	---	---	---	---	---	---	---	-----

Set flip layout

SOH	F	C	D	O	-	-	r	N	-	-	-	-	-	-	-	ETB
-----	---	---	---	---	---	---	---	---	---	---	---	---	---	---	---	-----

N = 0 – flip layout Off

N = 1 – flip layout On

Enquire flip layout

SOH	F	C	D	O	-	-	w	p	p	p	p	p	p	p	p	ETB
-----	---	---	---	---	---	---	---	---	---	---	---	---	---	---	---	-----

Answer

SOH	A	N	-	-	-	-	-	-	-	p	p	p	p	p	p	p	ETB
-----	---	---	---	---	---	---	---	---	---	---	---	---	---	---	---	---	-----

Set layout rotation

SOH	F	C	D	N	-	-	r	X	-	-	-	-	-	-	-	ETB
-----	---	---	---	---	---	---	---	---	---	---	---	---	---	---	---	-----

X = 0 – rotate layout Off

X = 1 – rotate layout On

Enquire layout rotation

SOH	F	C	D	N	-	-	w	p	p	p	p	p	p	p	p	ETB
-----	---	---	---	---	---	---	---	---	---	---	---	---	---	---	---	-----

Answer

SOH	A	X	-	-	-	-	-	-	-	p	p	p	p	p	p	p	ETB
-----	---	---	---	---	---	---	---	---	---	---	---	---	---	---	---	---	-----

Set operating mode flip/rotate label

SOH	F	C	D	S	-	-	r	N	-	-	-	-	-	-	-	-	ETB
-----	---	---	---	---	---	---	---	---	---	---	---	---	---	---	---	---	-----

N = 0 – flip/rotate label at the centre point of label
 N = 1 – flip/rotate label at the centre point of printhead

Enquire operating mode flip/rotate label

SOH	F	C	D	S	-	-	w	p	p	p	p	p	p	p	p	p	ETB
-----	---	---	---	---	---	---	---	---	---	---	---	---	---	---	---	---	-----

Answer

SOH	A	N	-	-	-	-	-	-	-	p	p	p	p	p	p	p	p	ETB
-----	---	---	---	---	---	---	---	---	---	---	---	---	---	---	---	---	---	-----

Device parameters

Set print position

SOH	F	C	A	D	K	-	r	N	N	N	N	N	N	-	-	ETB
-----	---	---	---	---	---	---	---	---	---	---	---	---	---	---	---	-----

NNNNN: print position in 1/10 mm (0120...0900)

Enquire print position

SOH	F	C	A	D	K	-	w	p	p	p	p	p	p	p	p	ETB
-----	---	---	---	---	---	---	---	---	---	---	---	---	---	---	---	-----

Answer

SOH	A	N	N	N	N	N	N	-	-	p	p	p	p	p	p	p	ETB
-----	---	---	---	---	---	---	---	---	---	---	---	---	---	---	---	---	-----

NNNNN: print position in 1/10 mm

Set operating mode

SOH	F	C	A	D	O	-	r	N	-	-	-	-	-	-	-	ETB
-----	---	---	---	---	---	---	---	---	---	---	---	---	---	---	---	-----

N = 0 - intermittent mode

N = 1 - continuous mode

After changing the operating mode, the module is re-started automatically.

Enquire operating mode

SOH	F	C	A	D	O	-	w	p	p	p	p	p	p	p	p	ETB
-----	---	---	---	---	---	---	---	---	---	---	---	---	---	---	---	-----

Answer

SOH	A	N	-	-	-	-	-	-	-	p	p	p	p	p	p	p	ETB
-----	---	---	---	---	---	---	---	---	---	---	---	---	---	---	---	---	-----

Set transfer ribbon control On/Off

SOH	F	C	D	B	-	-	r	N	M	-	-	-	-	-	-	ETB
-----	---	---	---	---	---	---	---	---	---	---	---	---	---	---	---	-----

N = 1 – transfer ribbon control Off

N = 0 – transfer ribbon control On

Enquire transfer ribbon control On/Off

SOH	F	C	D	B	-	-	w	p	p	p	p	p	p	p	p	ETB
-----	---	---	---	---	---	---	---	---	---	---	---	---	---	---	---	-----

Answer

SOH	A	N	M	-	-	-	-	-	-	p	p	p	p	p	p	p	ETB
-----	---	---	---	---	---	---	---	---	---	---	---	---	---	---	---	---	-----

Set field handling

SOH	F	C	D	K	-	-	r	N	-	-	-	-	-	-	-	ETB
-----	---	---	---	---	---	---	---	---	---	---	---	---	---	---	---	-----

N = 0 – field handling Off

N = 1 – graphic received

N = 2 – delete graphic

Enquire field handling

SOH	F	C	D	K	-	-	w	p	p	p	p	p	p	p	p	ETB
-----	---	---	---	---	---	---	---	---	---	---	---	---	---	---	---	-----

Answer

SOH	A	N	-	-	-	-	-	-	-	p	p	p	p	p	p	p	ETB
-----	---	---	---	---	---	---	---	---	---	---	---	---	---	---	---	---	-----

Set print module language

SOH	F	C	D	I	-	-	r	N	-	-	-	-	-	-	-	-	ETB
-----	---	---	---	---	---	---	---	---	---	---	---	---	---	---	---	---	-----

N = 0 – German
 N = 1 – English
 N = 2 – French
 N = 3 – Spanish
 N = 4 – Finnish
 N = 5 – Czech
 N = 6 – Portuguese
 N = 7 – Netherlands
 N = 8 – Italian
 N = 9 – Danish
 N = 10 – Polish

Enquire print module language

SOH	F	C	D	I	-	-	w	p	p	p	p	p	p	p	p	p	ETB
-----	---	---	---	---	---	---	---	---	---	---	---	---	---	---	---	---	-----

Answer

SOH	A	N	-	-	-	-	-	-	-	p	p	p	p	p	p	p	ETB
-----	---	---	---	---	---	---	---	---	---	---	---	---	---	---	---	---	-----

Set external print module parameter

SOH	F	C	C	P	-	-	r	N	-	-	-	-	-	-	-	-	ETB
-----	---	---	---	---	---	---	---	---	---	---	---	---	---	---	---	---	-----

N: 0 = only parameter settings by interface for label length, gap length and label width are taken into consideration.
 1 = parameter settings by interface are processed
 2 = parameter settings by interface are not taken into consideration

Enquire external print module parameter

SOH	F	C	C	P	-	-	w	p	p	p	p	p	p	p	p	p	ETB
-----	---	---	---	---	---	---	---	---	---	---	---	---	---	---	---	---	-----

Answer

SOH	A	N	-	-	-	-	-	-	-	p	p	p	p	p	p	p	ETB
-----	---	---	---	---	---	---	---	---	---	---	---	---	---	---	---	---	-----

Set Codepage

SOH	F	C	C	N	-	-	r	N	-	-	-	-	-	-	-	-	ETB
-----	---	---	---	---	---	---	---	---	---	---	---	---	---	---	---	---	-----

N = 0 - ANSI
 N = 1 - Codepage 437 (english)
 N = 2 - Codepage 850
 N = 3 - GEM German
 N = 4 - GEM English
 N = 5 - GEM French
 N = 6 - GEM Swedish
 N = 7 - GEM Danish
 N = 8 - Codepage 437 (Greek)
 N = 9 - Codepage 852 (Eastern European)
 N = 10 - Codepage 857 (Turkish)

Enquire Codepage

SOH	F	C	C	N	-	-	w	p	p	p	p	p	p	p	p	p	ETB
-----	---	---	---	---	---	---	---	---	---	---	---	---	---	---	---	---	-----

Answer

SOH	A	N	-	-	-	-	-	-	-	p	p	p	p	p	p	p	ETB
-----	---	---	---	---	---	---	---	---	---	---	---	---	---	---	---	---	-----

Set user guiding

SOH	F	C	D	U	-	-	r	N	-	-	-	-	-	-	-	-	ETB
-----	---	---	---	---	---	---	---	---	---	---	---	---	---	---	---	---	-----

N = 0 - Off, no entries are possible but pre-set values are printed

N = 1 - On, the user has to enter a value for each variable or to confirm the pre-set values by pressing the enter key. This default value is set each time the print module is switched on

N = 2 - Auto, the entries for a layout are repeated after each print and the last entered values are the new pre-set values

Enquire user guiding

SOH	F	C	D	U	-	-	w	p	p	p	p	p	p	p	p	p	ETB
-----	---	---	---	---	---	---	---	---	---	---	---	---	---	---	---	---	-----

Answer

SOH	A	N	-	-	-	-	-	-	-	p	p	p	p	p	p	p	ETB
-----	---	---	---	---	---	---	---	---	---	---	---	---	---	---	---	---	-----

Set keyboard layout

SOH	F	C	C	K	-	-	R	N	-	-	-	-	-	-	-	ETB
-----	---	---	---	---	---	---	---	---	---	---	---	---	---	---	---	-----

N = 0 – German keyboard

N = 1 – English keyboard

N = 2 – French keyboard

N = 3 – Greek keyboard

N = 4 – Spanish keyboard

N = 5 – Swedish keyboard

N = 6 – Czech keyboard

Enquire keyboard layout

SOH	F	C	C	K	-	-	w	p	p	p	p	p	p	p	p	p	ETB
-----	---	---	---	---	---	---	---	---	---	---	---	---	---	---	---	---	-----

Answer

SOH	A	N	-	-	-	-	-	-	-	p	p	p	p	p	p	p	ETB
-----	---	---	---	---	---	---	---	---	---	---	---	---	---	---	---	---	-----

Set sound level of key click (buzzer)

SOH	F	C	C	B	-	-	r	N	-	-	-	-	-	-	-	ETB
-----	---	---	---	---	---	---	---	---	---	---	---	---	---	---	---	-----

N = '0' – Buzzer Off

N = '1-7' – Sound level of key click

Enquire sound level of key click (buzzer)

SOH	F	C	C	B	-	-	w	p	p	p	p	p	p	p	p	ETB
-----	---	---	---	---	---	---	---	---	---	---	---	---	---	---	---	-----

Answer

SOH	A	N	-	-	-	-	-	-	-	p	p	p	p	p	p	p	ETB
-----	---	---	---	---	---	---	---	---	---	---	---	---	---	---	---	---	-----

Set hotstart On/Off

SOH	F	C	D	W	-	-	r	N	-	-	-	-	-	-	-	ETB
-----	---	---	---	---	---	---	---	---	---	---	---	---	---	---	---	-----

N = '0' – hotstart Off

N = '1' – hotstart On

Enquire hotstart On/Off

SOH	F	C	D	W	-	-	w	p	p	p	p	p	p	p	p	ETB
-----	---	---	---	---	---	---	---	---	---	---	---	---	---	---	---	-----

Answer

SOH	A	N	-	-	-	-	-	-	-	p	p	p	p	p	p	p	ETB
-----	---	---	---	---	---	---	---	---	---	---	---	---	---	---	---	---	-----

Set default layout On/Off

SOH	F	C	M	K	E	-	r	N	-	-	-	-	-	-	-	ETB
-----	---	---	---	---	---	---	---	---	---	---	---	---	---	---	---	-----

N = '0' – Off: Print start without layout definition signals error.

N = '1' – On: Default layout is printed without layout definition.

Default: Off

Enquire default layout On/Off

SOH	F	C	M	K	E	-	w	p	p	p	p	p	p	p	p	ETB
-----	---	---	---	---	---	---	---	---	---	---	---	---	---	---	---	-----

Answer

SOH	A	N	-	-	-	-	-	-	-	p	p	p	p	p	p	p	ETB
-----	---	---	---	---	---	---	---	---	---	---	---	---	---	---	---	---	-----

Set layout change confirmation

SOH	F	C	S	D	F	C	r	N	-	-	-	-	-	-	-	ETB
-----	---	---	---	---	---	---	---	---	---	---	---	---	---	---	---	-----

N = '0' – Confirmation Off

N = '1' – Confirmation On

Enquire layout change confirmation

SOH	F	C	S	D	F	C	w	p	p	p	p	p	p	p	p	ETB
-----	---	---	---	---	---	---	---	---	---	---	---	---	---	---	---	-----

Answer

SOH	A	N	-	-	-	-	-	-	-	p	p	p	p	p	p	p	ETB
-----	---	---	---	---	---	---	---	---	---	---	---	---	---	---	---	---	-----

Set 'print after measuring'

SOH	F	C	S	D	F	D	r	N	-	-	-	-	-	-	-	ETB
-----	---	---	---	---	---	---	---	---	---	---	---	---	---	---	---	-----

N = '0' – Off

N = '1' – On

Enquire 'print after measuring'

SOH	F	C	S	D	F	D	w	p	p	p	p	p	p	p	p	ETB
-----	---	---	---	---	---	---	---	---	---	---	---	---	---	---	---	-----

Answer

SOH	A	N	-	-	-	-	-	-	-	p	p	p	p	p	p	p	ETB
-----	---	---	---	---	---	---	---	---	---	---	---	---	---	---	---	---	-----

Interface

You can set the parameter of the serial interface by the following commands but you have to note that after sending one of the commands also the host computer changes the corresponding parameter of its interface to allow further communications Host computer – print module.

For all interface commands the interface is fixed with x. Allowed are the following values:

x = 1 ⇒ COM 1

x = 2 ⇒ COM 2

In all other cases automatically the first serial interface is addressed.

In the answers the addressed interface is also returned.

Set all interface parameter

SOH	F	C	F	F	x	-	r	m	;	b	;	p	;	d	;	s	ETB
-----	---	---	---	---	---	---	---	---	---	---	---	---	---	---	---	---	-----

m = mode (0 = Off, 1 = On, 2 = On, without error message)

b = Baudrate (2400, 4800, 9600, 19200, 38400, 57600, 115200)

p = parity (n = no parity, e = even parity, o = odd parity)

d = number of data bits (7, 8)

s = number of stop bits (1, 2)

Enquire all interface parameter

SOH	F	C	F	F	x	-	w	p	p	p	p	p	p	p	p	p	ETB
-----	---	---	---	---	---	---	---	---	---	---	---	---	---	---	---	---	-----

Answer

SOH	A	x	;	m	;	b	;	p	;	d	;	s	;	p	p	p	p	p	p	p	p	p	p	ETB
-----	---	---	---	---	---	---	---	---	---	---	---	---	---	---	---	---	---	---	---	---	---	---	---	-----

Example: activate interface COM1 and set 9600 Baud, no parity, 8 data bits, 2 stop bits
[SOH]FCFF1-r1;9600;n;8;2[ETB]

Interface protocol

There are two different interface protocols available. Usually SOH = 01_{Hex} and ETB = 17_{Hex}. However there are host computers (e.g. AS/400), which can not work with these characters. Therefore you can switch SOH = 5E_{Hex} and ETB = 5F_{Hex}. The host computer has to change the corresponding parameter as well.

Set SOH and ETB

SOH	F	C	G	C	-	-	r	N	-	-	-	-	-	-	-	-	ETB
-----	---	---	---	---	---	---	---	---	---	---	---	---	---	---	---	---	-----

N = 0 - SOH = 01_{Hex}, ETB = 17_{Hex}

N = 1 - SOH = 5E_{Hex}, ETB = 5F_{Hex}

Enquire SOH and ETB

SOH	F	C	G	C	-	-	w	p	p	p	p	p	p	p	p	p	ETB
-----	---	---	---	---	---	---	---	---	---	---	---	---	---	---	---	---	-----

Answer

SOH	A	N	-	-	-	-	-	-	-	p	p	p	p	p	p	p	p	ETB
-----	---	---	---	---	---	---	---	---	---	---	---	---	---	---	---	---	---	-----

Data memory

Set data memory

SOH	F	C	G	D	-	-	r	M	-	-	-	-	-	-	-	-	ETB
-----	---	---	---	---	---	---	---	---	---	---	---	---	---	---	---	---	-----

M = 0 Off, after receiving FBCA0r or FBDA0r the interface is locked until the end of the print order, i.e. you cannot write more data in the receiving buffer.

M = 1 Standard, after starting a print order no data of the receiving buffer are processed but it is possible to write more data in the receiving buffer until it is full.

M = 2 Extended, after starting a print order it is possible to write more data in the receiving buffer. These data is processed during the print and the next layout is prepared.

Enquire data memory

SOH	F	C	G	D	-	-	w	p	p	p	p	p	p	p	p	p	ETB
-----	---	---	---	---	---	---	---	---	---	---	---	---	---	---	---	---	-----

Answer

SOH	A	M	-	-	-	-	-	-	-	p	p	p	p	p	p	p	ETB
-----	---	---	---	---	---	---	---	---	---	---	---	---	---	---	---	---	-----

Set reaction to unknown interrogative set

SOH	F	C	G	E	A	-	r	N	-	-	-	-	-	-	-	ETB
-----	---	---	---	---	---	---	---	---	---	---	---	---	---	---	---	-----

N – Indication of value between 0 and 3

Enquire reaction to unknown interrogative set

SOH	F	C	G	E	A	-	w	p	p	p	p	p	p	p	p	p	ETB
-----	---	---	---	---	---	---	---	---	---	---	---	---	---	---	---	---	-----

Answer

SOH	A	N	-	-	-	-	-	-	-	p	p	p	p	p	p	p	ETB
-----	---	---	---	---	---	---	---	---	---	---	---	---	---	---	---	---	-----

Set port transmission

SOH	F	C	G	F	-	-	r	S	T	-	-	-	-	-	-	ETB
-----	---	---	---	---	---	---	---	---	---	---	---	---	---	---	---	-----

S - Source (indication of source port)

T - Target (indication of target source)

Port numbers: 1 - 6

Port number:

- 1 = COM1
- 2 = COM2 (depending on printer)
- 3 = LPT
- 4 = USB
- 5 = TCP (option)
- 6 = UDP (option)

Enquire port transmission

SOH	F	C	G	F	-	-	w	p	p	p	p	p	p	p	p	ETB
-----	---	---	---	---	---	---	---	---	---	---	---	---	---	---	---	-----

Answer

SOH	A	"	S1-T1	;	S2-T2	;	...	ID	:	p	p	p	p	p	p	p	"	ETB
-----	---	---	-------	---	-------	---	-----	----	---	---	---	---	---	---	---	---	---	-----

Network

General

SOH	F	C	L	A	-	-	r	C	0	A	8	0	0	1	5	ETB
-----	---	---	---	---	---	---	---	---	---	---	---	---	---	---	---	-----

All network parameter sets start in the third column with a 'L'. Column 4 shows the identification for the corresponding network parameter. Column 5 can show another sub-identification.

Because of the fact that the argument size is limited to 8 characters, the IP addresses (IP address, network mask, gateway address) which consist of 32 bit are transmitted in HEX presentation. For all data which is transmitted in HEX presentation (also the MAC address) it is allowed to use capital as well as small letters.

In contrary to the parameter settings of the other interfaces, the settings of the following sets were saved immediately onto Flash, i.e. it is not necessary to save the currently set configuration before switching off the printer so the modifications are still available after switching on.

So that the made modifications become active, also without printer Reset it is necessary to transmit a corresponding Z set which effects a Reset of the network devices.

Set IP address (e.g. 192.168.0.21)

SOH	F	C	L	A	-	-	r	C	0	A	8	0	0	1	5	ETB
-----	---	---	---	---	---	---	---	---	---	---	---	---	---	---	---	-----

Enquire IP address

SOH	F	C	L	A	-	-	w	C	0	A	8	0	0	1	5	ETB
-----	---	---	---	---	---	---	---	---	---	---	---	---	---	---	---	-----

Answer

SOH	A	C	0	A	8	0	0	1	5	p	p	p	p	p	p	p	ETB
-----	---	---	---	---	---	---	---	---	---	---	---	---	---	---	---	---	-----

Set netmask (e.g. 255.255.255.0)

SOH	F	C	L	B	-	-	r	F	F	F	F	F	F	0	0	ETB
-----	---	---	---	---	---	---	---	---	---	---	---	---	---	---	---	-----

Enquire netmask

SOH	F	C	L	B	-	-	w	F	F	F	F	F	F	0	0	ETB
-----	---	---	---	---	---	---	---	---	---	---	---	---	---	---	---	-----

Answer

SOH	A	F	F	F	F	F	F	0	0	p	p	p	p	p	p	p	ETB
-----	---	---	---	---	---	---	---	---	---	---	---	---	---	---	---	---	-----

Set Gateway address (e.g. 192.168.0.1)

SOH	F	C	L	C	-	-	r	C	0	A	8	0	0	0	1	ETB
-----	---	---	---	---	---	---	---	---	---	---	---	---	---	---	---	-----

Enquire Gateway address

SOH	F	C	L	C	-	-	w	C	0	A	8	0	0	0	1	ETB
-----	---	---	---	---	---	---	---	---	---	---	---	---	---	---	---	-----

Answer

SOH	A	C	0	A	8	0	0	0	1	p	p	p	p	p	p	p	ETB
-----	---	---	---	---	---	---	---	---	---	---	---	---	---	---	---	---	-----

Set transmission mode (e.g. auto recognition)

SOH	F	C	L	D	-	-	r	0	-	-	-	-	-	-	-	-	ETB
-----	---	---	---	---	---	---	---	---	---	---	---	---	---	---	---	---	-----

0 = auto recognition

3 = 100 MBit/s half duplex

1 = 10 MBit/s half duplex

4 = 100 MBit/s full duplex

2 = 10 MBit/s full duplex

Enquire transmission mode

SOH	F	C	L	D	-	-	w	0	-	-	-	-	-	-	-	-	ETB
-----	---	---	---	---	---	---	---	---	---	---	---	---	---	---	---	---	-----

Answer

SOH	A	0	-	-	-	-	-	-	-	p	p	p	p	p	p	p	p	ETB
-----	---	---	---	---	---	---	---	---	---	---	---	---	---	---	---	---	---	-----

Set support DHCP

SOH	F	C	L	E	-	-	r	N	ETB
-----	---	---	---	---	---	---	---	---	-----

N: 0 = Off

1 = On

Enquire support DHCP

SOH	F	C	L	E	-	-	w	p	p	p	p	p	p	p	p	p	p	ETB
-----	---	---	---	---	---	---	---	---	---	---	---	---	---	---	---	---	---	-----

Answer

SOH	A	N	-	-	-	-	-	-	-	p	p	p	p	p	p	p	p	ETB
-----	---	---	---	---	---	---	---	---	---	---	---	---	---	---	---	---	---	-----

Assign printer name

SOH	F	C	L	F	-	-	r	N	N	N	N	N	N	N	N	N	N	N	ETB
-----	---	---	---	---	---	---	---	---	---	---	---	---	---	---	---	---	---	---	-----

N: printer name is allowed to exist of max. 11 characters (A...Z, a...z, 0...9, -,)

Enquire printer name

SOH	F	C	L	F	-	-	w	p	p	p	p	p	p	p	p	p	p	ETB
-----	---	---	---	---	---	---	---	---	---	---	---	---	---	---	---	---	---	-----

Answer

SOH	A	N	N	N	N	N	N	N	N	;	p	p	p	p	p	p	p	ETB
-----	---	---	---	---	---	---	---	---	---	---	---	---	---	---	---	---	---	-----

Set MAC address (e.g. 00-07-4A-43-19-08)

SOH	F	C	L	M	B	-	r	0	0	0	7	4	A	-	-	ETB
-----	---	---	---	---	---	---	---	---	---	---	---	---	---	---	---	-----

SOH	F	C	L	M	A	-	r	4	3	1	9	0	8	-	-	ETB
-----	---	---	---	---	---	---	---	---	---	---	---	---	---	---	---	-----

A MAC address has a width of 48 bit and is normally indicated in hexadecimals.

With a B record it is possible to modify our identification of the MAC address. All our machines start with 00-07-4A as default. This corresponds to the Memory-Pool which the MAC address committee assigned to us to guarantee that the MAC address is world-wide manufacturer-spreading unique.

With the A record it is possible to set any address in our pool.

Enquire MAC address

SOH	F	C	L	M	B	-	w	0	0	0	7	4	A	-	-	ETB
-----	---	---	---	---	---	---	---	---	---	---	---	---	---	---	---	-----

SOH	F	C	L	M	A	-	w	4	3	1	9	0	8	-	-	ETB
-----	---	---	---	---	---	---	---	---	---	---	---	---	---	---	---	-----

Answer

SOH	A	0	0	0	7	4	A	-	-	p	p	p	p	p	p	p	p	ETB
-----	---	---	---	---	---	---	---	---	---	---	---	---	---	---	---	---	---	-----

SOH	A	4	3	1	9	0	8	-	-	p	p	p	p	p	p	p	p	ETB
-----	---	---	---	---	---	---	---	---	---	---	---	---	---	---	---	---	---	-----

NTP Server

NTP (Network Time Protocol) is a standardised Internet protocol permitting the synchronisation of real-time clocks of network participants. The printer connects itself with a time server and align every 60 minutes its internal real-time clock with that of the time server in order to correct possible differences.

The address of server (IP address) can be freely configured in the printer. The communication is effected by UDP and the fixed set port 123. The service in the printer is deactivated by transmitting the server address 0.0.0.0.

The time servers work together with the coordinated world time (UTC) and therefore an additional time shift is needed compared to the reference time. For Germany it is e.g. +1 hour.

The current state of the connexion can be queried with a status set.

Set NTP Server IP

SOH	F	C	L	N	I	-	r	N	ETB
-----	---	---	---	---	---	---	---	---	-----

N = X.X.X.X (X = 0...255)

Enquire NTP Server IP

SOH	F	C	L	N	I	-	w	pppppppp	ETB
-----	---	---	---	---	---	---	---	----------	-----

Answer

SOH	A	N	N	N	N	N	N	N	N	p	p	p	p	p	p	p	p	ETB
-----	---	---	---	---	---	---	---	---	---	---	---	---	---	---	---	---	---	-----

0.0.0.0 deactivates the NTP service

Readout NTP status

SOH	F	C	L	N	S	-	w	pppppppp	ETB
-----	---	---	---	---	---	---	---	----------	-----

Answer

SOH	A	N	-	-	-	-	-	-	p	p	p	p	p	p	p	p	ETB
-----	---	---	---	---	---	---	---	---	---	---	---	---	---	---	---	---	-----

N: OK / ERROR / OFF

Set time zone (hour offset)

SOH	F	C	L	N	Z	-	r	N	ETB
-----	---	---	---	---	---	---	---	---	-----

N: -12, 12

Enquire time zone (hour offset)

SOH	F	C	L	N	Z	-	w	pppppppp	ETB
-----	---	---	---	---	---	---	---	----------	-----

Answer

SOH	A	N	N	N	N	N	N	N	N	p	p	p	p	p	p	p	ETB
-----	---	---	---	---	---	---	---	---	---	---	---	---	---	---	---	---	-----

Reset network device

SOH	F	C	L	Z	-	-	r	-----	ETB
-----	---	---	---	---	---	---	---	-------	-----

For this set is no enquiry possible. This set causes that modifications made by the transfer of the previous sets become effective.

Sensors

Enquire condition of compressed air

SOH	F	C	M	B	H	-	w	p	p	p	p	p	p	p	p	p	ETB
-----	---	---	---	---	---	---	---	---	---	---	---	---	---	---	---	---	-----

Answer

SOH	A	N	-	-	-	-	-	-	-	p	p	p	p	p	p	p	p	ETB
-----	---	---	---	---	---	---	---	---	---	---	---	---	---	---	---	---	---	-----

N = 0 – no or not enough compressed air

N = 1 – compressed air OK

Enquire condition of cover*

SOH	F	C	M	B	I	-	w	p	p	p	p	p	p	p	p	p	ETB
-----	---	---	---	---	---	---	---	---	---	---	---	---	---	---	---	---	-----

Answer

SOH	A	N	-	-	-	-	-	-	-	p	p	p	p	p	p	p	p	ETB
-----	---	---	---	---	---	---	---	---	---	---	---	---	---	---	---	---	---	-----

N = 0 – cover is open

N = 1 – cover is closed

Service functions

Set Online / Offline

SOH	F	C	M	K	C	-	r	M	-	-	-	-	-	-	-	-	-	ETB
-----	---	---	---	---	---	---	---	---	---	---	---	---	---	---	---	---	---	-----

M = 0 – Online/Offline Off

M = 1 – Online/Offline On

Enquire Online/Offline

SOH	F	C	M	K	C	-	w	p	p	p	p	p	p	p	p	p	p	ETB
-----	---	---	---	---	---	---	---	---	---	---	---	---	---	---	---	---	---	-----

Answer

SOH	A	M	-	-	-	-	-	-	-	p	p	p	p	p	p	p	p	ETB
-----	---	---	---	---	---	---	---	---	---	---	---	---	---	---	---	---	---	-----

After changing by interface the display is automatically new initialised (by activated online/offline changing to online indication).

Set reprint action

SOH	F	C	M	K	D	-	r	N	-	-	-	-	-	-	-	-	-	ETB
-----	---	---	---	---	---	---	---	---	---	---	---	---	---	---	---	---	---	-----

Enquire reprint action

SOH	F	C	M	K	D	-	w	p	p	p	p	p	p	p	p	p	p	ETB
-----	---	---	---	---	---	---	---	---	---	---	---	---	---	---	---	---	---	-----

N = 0: Reprint complete

N = 1: Reprint is blank

Answer

SOH	A	N	-	-	-	-	-	-	-	p	p	p	p	p	p	p	p	ETB
-----	---	---	---	---	---	---	---	---	---	---	---	---	---	---	---	---	---	-----

Close printhead

SOH	F	C	M	B	C	-	r	N	-	-	-	-	-	-	-	-	-	ETB
-----	---	---	---	---	---	---	---	---	---	---	---	---	---	---	---	---	---	-----

N = 1 – printhead down (closed)

Enquire condition of printhead photocell

SOH	F	C	M	B	C	-	w	p	p	p	p	p	p	p	p	p	p	ETB
-----	---	---	---	---	---	---	---	---	---	---	---	---	---	---	---	---	---	-----

Answer

SOH	A	N	-	-	-	-	-	-	-	p	p	p	p	p	p	p	p	ETB
-----	---	---	---	---	---	---	---	---	---	---	---	---	---	---	---	---	---	-----

N = 0: printhead is open

N = 1: printhead is closed

Open printhead

SOH	F	C	M	B	D	-	r	N	-	-	-	-	-	-	-	-	-	ETB
-----	---	---	---	---	---	---	---	---	---	---	---	---	---	---	---	---	---	-----

N = 1 – printhead up (open)

Enquire condition of printhead

SOH	F	C	M	B	C	-	w	p	p	p	p	p	p	p	p	p	p	ETB
-----	---	---	---	---	---	---	---	---	---	---	---	---	---	---	---	---	---	-----

Answer

SOH	A	N	-	-	-	-	-	-	-	p	p	p	p	p	p	p	p	ETB
-----	---	---	---	---	---	---	---	---	---	---	---	---	---	---	---	---	---	-----

N = 0: printhead is open

N = 1: printhead is down

Enquire printhead temperature

SOH	F	C	M	C	-	-	w	p	p	p	p	p	p	p	p	ETB
-----	---	---	---	---	---	---	---	---	---	---	---	---	---	---	---	-----

Answer

SOH	A	N	-	-	-	-	-	-	p	p	p	p	p	p	p	p	ETB
-----	---	---	---	---	---	---	---	---	---	---	---	---	---	---	---	---	-----

NNN: value of printhead temperature, 3 digit ASCII number in 1/100 degree

Set transfer ribbon length

SOH	F	C	D	Q	A	-	r	N	N	N	N	-	-	-	-	ETB
-----	---	---	---	---	---	---	---	---	---	---	---	---	---	---	---	-----

NNNN: value of transfer ribbon length in m
Possible entries: 300, 450, 600, 900 or 1000

Enquire transfer ribbon length

SOH	F	C	D	Q	A	-	w	p	p	p	p	p	p	p	p	p	ETB
-----	---	---	---	---	---	---	---	---	---	---	---	---	---	---	---	---	-----

Answer

SOH	A	N	-	-	-	-	-	-	p	p	p	p	p	p	p	p	ETB
-----	---	---	---	---	---	---	---	---	---	---	---	---	---	---	---	---	-----

Set transfer ribbon prior warning

SOH	F	C	M	L	A	-	r	N	-	-	-	-	-	-	-	ETB
-----	---	---	---	---	---	---	---	---	---	---	---	---	---	---	---	-----

N = 0: Off

N = 1: On

Enquire transfer ribbon prior warning

SOH	F	C	M	L	A	-	w	p	p	p	p	p	p	p	p	p	ETB
-----	---	---	---	---	---	---	---	---	---	---	---	---	---	---	---	---	-----

Answer

SOH	A	N	-	-	-	-	-	-	p	p	p	p	p	p	p	p	ETB
-----	---	---	---	---	---	---	---	---	---	---	---	---	---	---	---	---	-----

Set diameter for transfer ribbon prior warning

SOH	F	C	M	L	B	-	r	N	N	N	-	-	-	-	-	ETB
-----	---	---	---	---	---	---	---	---	---	---	---	---	---	---	---	-----

NNN = 030 ... 090 diameter in mm

Enquire diameter for transfer ribbon prior warning

SOH	F	C	M	L	B	-	w	p	p	p	p	p	p	p	p	p	ETB
-----	---	---	---	---	---	---	---	---	---	---	---	---	---	---	---	---	-----

Answer

SOH	A	N	-	-	-	-	-	-	p	p	p	p	p	p	p	p	ETB
-----	---	---	---	---	---	---	---	---	---	---	---	---	---	---	---	---	-----

Set printhead resistance

SOH	F	C	M	G	-	-	r	N	N	N	N	N	-	-	-	ETB
-----	---	---	---	---	---	---	---	---	---	---	---	---	---	---	---	-----

NNNNN = Indication of resistance value in Ohm.

Enquire printhead resistance

SOH	F	C	M	G	-	-	w	p	p	p	p	p	p	p	p	p	ETB
-----	---	---	---	---	---	---	---	---	---	---	---	---	---	---	---	---	-----

Answer

SOH	A	N	N	N	N	N	-	-	-	p	p	p	p	p	p	p	ETB
-----	---	---	---	---	---	---	---	---	---	---	---	---	---	---	---	---	-----

Mileage (kilometre) counter

It is only possible to enquire the kilometre values of print module and printhead by interface and not to set them to 0.

Enquire print module's mileage

SOH	F	C	H	A	-	-	w	p	p	p	p	p	p	p	p	p	ETB
-----	---	---	---	---	---	---	---	---	---	---	---	---	---	---	---	---	-----

Answer

SOH	A	N	N	N	N	N	N	N	N	N	p	p	p	p	p	p	p	ETB
-----	---	---	---	---	---	---	---	---	---	---	---	---	---	---	---	---	---	-----

Enquire printhead's mileage

SOH	F	C	H	B	-	-	w	p	p	p	p	p	p	p	p	p	ETB
-----	---	---	---	---	---	---	---	---	---	---	---	---	---	---	---	---	-----

Answer

SOH	A	N	N	N	N	N	N	N	N	N	p	p	p	p	p	p	p	ETB
-----	---	---	---	---	---	---	---	---	---	---	---	---	---	---	---	---	---	-----

NNNNNNNN = Indication of mileage of print module res. printhead in meters
(e.g. '00000123' = 123 m)

Date & Time

Set date

SOH	F	C	I	A	-	-	r	D	D	M	O	Y	Y	D	W	ETB
-----	---	---	---	---	---	---	---	---	---	---	---	---	---	---	---	-----

DD = day of month

MO = month

YY = year

DW = day of week ('00' = Sunday)

Enquire date

SOH	F	C	I	A	-	-	w	p	p	p	p	p	p	p	p	ETB
-----	---	---	---	---	---	---	---	---	---	---	---	---	---	---	---	-----

Answer

SOH	A	D	D	M	O	Y	Y	D	W	p	p	p	p	p	p	p	ETB
-----	---	---	---	---	---	---	---	---	---	---	---	---	---	---	---	---	-----

Set time

SOH	F	C	I	B	-	-	r	H	H	M	I	S	S	A	M	ETB
-----	---	---	---	---	---	---	---	---	---	---	---	---	---	---	---	-----

HH = hours

MI = minutes

SS = seconds

AM = mode ('am' = 12 hours mode AM, 'pm' = 12 hours mode PM, '—' = 24 hours mode)

Enquire time

SOH	F	C	I	B	-	-	w	p	p	p	p	p	p	p	p	ETB
-----	---	---	---	---	---	---	---	---	---	---	---	---	---	---	---	-----

Answer

SOH	A	H	H	M	I	S	S	A	M	p	p	p	p	p	p	p	ETB
-----	---	---	---	---	---	---	---	---	---	---	---	---	---	---	---	---	-----

Automatically adjust clock for daylight saving changes

Because of the fact that there is no world-wide regulation if and when a changing of time between summer and wintertime (normal time) in the individual countries takes place, we distinguish between the following four formats for the definition for beginning and end of summertime.

F 0:	european format start of summertime = last Sunday in March end of summertime = last Sunday in October W: week (1 = first, ..., 5 = last) WD: day of week (0 = Sunday, ..., 6 = Saturday) MM: month (01 = January, ..., 12 = December)
F 1:	fix date with indication of year DD: day MM: month (01 = January, ..., 12 = December) YY: year
F 2:	fix date without indication of year DD: day MM: month (01 = January, ..., 12 = December)
F 3:	week day after day in month WD: day of week (0 = Sunday, ..., 6 = Saturday) DD: after day (only the first day is taken into consideration) MM: month (01 = January, ..., 12 = December)

Set automatically adjust clock for daylight saving changes

SOH	F	C	I	G	-	-	r	N	-	-	-	-	-	-	-	-	ETB
-----	---	---	---	---	---	---	---	---	---	---	---	---	---	---	---	---	-----

Enquire automatically adjust clock for daylight saving changes

SOH	F	C	I	G	-	-	w	p	p	p	p	p	p	p	p	p	ETB
-----	---	---	---	---	---	---	---	---	---	---	---	---	---	---	---	---	-----

Answer

SOH	A	N	-	-	-	-	-	-	-	p	p	p	p	p	p	p	ETB
-----	---	---	---	---	---	---	---	---	---	---	---	---	---	---	---	---	-----

N = 0 – Automatically adjust clock for daylight saving changes Off

N = 1 – Automatically adjust clock for daylight saving changes On

Set beginning of summertime

F 0: SOH F C I H - - r F W ; WD ; M M ; H H ; M M ETB

F 1: SOH F C I H - - r F D D ; M M ; Y Y ; H H ; M M ETB

F 2: SOH F C I H - - r F D D ; M M ; H H ; M M ETB

F 3: SOH F C I H - - r F WD ; D D ; M M ; H H ; M M ETB

Enquire beginning of summertime

SOH F C I H - - w p p p p p p p p ETB

Answer

SOH A F W W D M M p p p p p p p p ETB

The answer depends on each set format.

Set end of summertime

F 0: SOH F C I I - - r F W ; WD ; M M ; H H ; M M ETB

F 1: SOH F C I I - - r F D D ; M M ; Y Y ; H H ; M M ETB

F 2: SOH F C I I - - r F D D ; M M ; H H ; M M ETB

F 3: SOH F C I I - - r F WD ; D D ; M M ; H H ; M M ETB

Enquire end of summertime

SOH F C I I - - w p p p p p p p p ETB

Answer

SOH A F W W D M M p p p p p p p p ETB

The answer depends on each set format.

Set time shifting

SOH F C I J - - r N N N - - - - - ETB

NNN = minutes

Enquire time shifting

SOH F C I J - - w p p p p p p p p ETB

Answer

SOH A N N N p p p p p p p p ETB

Password

Set password

SOH	F	C	K	A	-	-	r	N	N	N	N	-	-	-	-	ETB
-----	---	---	---	---	---	---	---	---	---	---	---	---	---	---	---	-----

NNN: Indication of password, 4 digit ASCII number in mm (0000 ... 9999)

Enquire password

SOH	F	C	K	A	-	-	w	p	p	p	p	p	p	p	p	ETB
-----	---	---	---	---	---	---	---	---	---	---	---	---	---	---	---	-----

Answer

SOH	A	N	N	N	N	-	-	-	-	p	p	p	p	p	p	p	ETB
-----	---	---	---	---	---	---	---	---	---	---	---	---	---	---	---	---	-----

Set function group

SOH	F	C	K	B	-	-	r	A	B	C	D	-	-	-	-	ETB
-----	---	---	---	---	---	---	---	---	---	---	---	---	---	---	---	-----

A - Function menu

0 = free

1 = blocked

B - Compact Flash card

0 = free

1 = only reading access

2 = access blocked

C - Entry

0 = free

1 = only masks blocked

2 = no entry possible

D - Print module guiding

0 = free

1 = entry of number of pieces possible

2 = no manual print release

Enquire function group

SOH	F	C	K	B	-	-	w	p	p	p	p	p	p	p	p	ETB
-----	---	---	---	---	---	---	---	---	---	---	---	---	---	---	---	-----

Answer

SOH	A	a	b	c	d	-	-	-	-	p	p	p	p	p	p	p	ETB
-----	---	---	---	---	---	---	---	---	---	---	---	---	---	---	---	---	-----

Set password active

SOH	F	C	K	C	-	-	r	N	-	-	-	-	-	-	-	ETB
-----	---	---	---	---	---	---	---	---	---	---	---	---	---	---	---	-----

N = 0 – inactive (N in display)

N = 1 – active (J in display)

Enquire password active

SOH	F	C	K	C	-	-	w	p	p	p	p	p	p	p	p	ETB
-----	---	---	---	---	---	---	---	---	---	---	---	---	---	---	---	-----

Answer

SOH	A	N	-	-	-	-	-	-	-	p	p	p	p	p	p	p	ETB
-----	---	---	---	---	---	---	---	---	---	---	---	---	---	---	---	---	-----

Compact Flash Card

Save a label onto Compact Flash Card

SOH	F	M	A	O	-	-	r	F	ETB
-----	---	---	---	---	---	---	---	---	-----

O - In case a label with the entered name exists already then the label is overwritten without an enquiry.

If you enter another value as 0, an enquiry appears demanding if you want to overwrite.

F - File name of the label which is to save. Drive and path name are optional, i.e. the file name is allowed to have more than 8 characters but is limited to 79.

Load a file from Compact Flash Card

SOH	F	M	B	-	-	-	r	F	ETB
-----	---	---	---	---	---	---	---	---	-----

F - File name of file which is to load. Drive and path name are optional, i.e. the file name is allowed to have more than 8 characters but is limited to 79.

Delete a label from Compact Flash Card

SOH	F	M	C	-	-	-	r	F	ETB
-----	---	---	---	---	---	---	---	---	-----

F - File name of label which is to delete. Drive and path name are optional, i.e. the file name is allowed to have more than 8 characters but is limited to 79.

Format Compact Flash Card

SOH	F	M	D	-	-	-	r	D	ETB
-----	---	---	---	---	---	---	---	---	-----

D - Optional drive identification with colon (e.g. A:).

In case no drive is indicated, then the currently selected is formatted.

Readout free memory space

SOH	F	M	H	-	-	-	w	X	p	p	p	p	p	p	p	p	p	ETB
-----	---	---	---	---	---	---	---	---	---	---	---	---	---	---	---	---	---	-----

X = Drive [A,B] (optional)

Answer:

SOH	A	X	n	n	n	n	-	-	-	p	p	p	p	p	p	p	p	ETB
-----	---	---	---	---	---	---	---	---	---	---	---	---	---	---	---	---	---	-----

X = Drive [A,B]

n = Memory space in KB

Create directory

SOH	F	M	I	-	-	-	r	P	ETB
-----	---	---	---	---	---	---	---	---	-----

P = Drive and directory identification

Create directory

(create directory without warning in case the directory is already existing)

SOH	F	M	I	O	-	-	r	P	ETB
-----	---	---	---	---	---	---	---	---	-----

O - In case a directory with the entered name already exists, then it is overwritten without an enquiry.

If you enter another value as O, an enquiry appears demanding if you want to overwrite.

P - Drive and directory identification

Delete directory

SOH	F	M	J	-	-	-	r	P	ETB
-----	---	---	---	---	---	---	---	---	-----

P = Drive and directory identification

Note that it is impossible to delete the current directory!

Change standard directory

SOH	F	M	K	-	-	-	r	P	ETB
-----	---	---	---	---	---	---	---	---	-----

P = Drive and directory identification

Readout standard directory

SOH	F	M	K	-	-	-	w	ETB
-----	---	---	---	---	---	---	---	-----

P = Drive and directory identification

Answer

SOH	A	P	ETB
-----	---	---	-----

P = Current directory

Set standard directory for file selection via I/O

SOH	F	M	K	B	-	-	r	N	ETB
-----	---	---	---	---	---	---	---	---	-----

N = directory path

Enquire standard directory for file selection via I/O

SOH	F	M	K	B	-	-	w	p	p	p	p	p	p	p	p	ETB
-----	---	---	---	---	---	---	---	---	---	---	---	---	---	---	---	-----

Answer

SOH	A	N	-	-	-	-	-	-	p	p	p	p	p	p	p	p	ETB
-----	---	---	---	---	---	---	---	---	---	---	---	---	---	---	---	---	-----

Transfer file from printer

SOH	F	M	L	-	-	-	w	F	ETB
-----	---	---	---	---	---	---	---	---	-----

F - File name of file which is to transfer. Drive and path name are optional, i.e. the file name is allowed to have more than 8 characters but is limited to 79.

Answer:

SOH	A	F	*	S	ETB	<i>Data</i>
-----	---	---	---	---	-----	-------------

F = File name

S = File size in in Byte

Data = Binary data

Printing**Start /Stop command**

Additionally to the start / stop command it is possible to interrupt a print order via parameter / remote set.

SOH	F	D	-	-	-	-	r	N	-	-	-	-	-	-	-	ETB
-----	---	---	---	---	---	---	---	---	---	---	---	---	---	---	---	-----

N = '0' – interrupt printing

N = '1' – continue printing

N = '2' – cancel print order, when it is already stopped

Reset error**Reset error**

SOH	F	C	M	H	-	-	r	N	N	N	N	-	-	-	-	ETB
-----	---	---	---	---	---	---	---	---	---	---	---	---	---	---	---	-----

NNNN = Indication of current error ID or '9999"

Enquire error

SOH	F	C	M	H	-	-	w	p	p	p	p	p	p	p	p	p	ETB
-----	---	---	---	---	---	---	---	---	---	---	---	---	---	---	---	---	-----

Answer

SOH	A	N	N	N	N	0	0	0	0	p	p	p	p	p	p	p	p	ETB
-----	---	---	---	---	---	---	---	---	---	---	---	---	---	---	---	---	---	-----

Readout error ID and error text

SOH	F	C	M	H	A	-	w	p	p	p	p	p	p	p	p	p	ETB
-----	---	---	---	---	---	---	---	---	---	---	---	---	---	---	---	---	-----

Answer

SOH	A	N	N	N	N	;	error text	;	p	p	p	p	p	p	p	p	p	ETB
-----	---	---	---	---	---	---	------------	---	---	---	---	---	---	---	---	---	---	-----

Item number of print order

By means of this command the Host computer can enquire following item numbers:

Complete number of current print order

SOH	F	B	B	A	-	-	w	p	p	p	p	p	p	p	p	p	ETB
-----	---	---	---	---	---	---	---	---	---	---	---	---	---	---	---	---	-----

Number of layouts which are still to print

SOH	F	B	B	B	-	-	w	p	p	p	p	p	p	p	p	p	ETB
-----	---	---	---	---	---	---	---	---	---	---	---	---	---	---	---	---	-----

Number of layouts which are already printed

SOH	F	B	B	C	-	-	w	p	p	p	p	p	p	p	p	p	ETB
-----	---	---	---	---	---	---	---	---	---	---	---	---	---	---	---	---	-----

At the end of one of these commands the print module returns the corresponding number as ASCII value

(4 res. 5 digits) in the answer set.

Answer

SOH	A	N	N	N	N	-	-	-	-	p	p	p	p	p	p	p	ETB
-----	---	---	---	---	---	---	---	---	---	---	---	---	---	---	---	---	-----

With this set it is also possible to transmit the item number of print order and the interval (in cutter mode) to the print module.

Item number of print order

SOH	F	B	B	A	-	-	r	N	N	N	N	N	-	-	-	ETB
-----	---	---	---	---	---	---	---	---	---	---	---	---	---	---	---	-----

NNNNN: 5 digits item number of order

Start printing

SOH	F	B	C	-	-	-	r	-	-	-	-	-	-	-	-	-	ETB
-----	---	---	---	---	---	---	---	---	---	---	---	---	---	---	---	---	-----

This command starts the print order which is actually set in the print module. The current parameter such as print mode, speed, initialisation etc. are used. Therefore it is possible to print e.g. item numbers with 5 digits. However, before you have to transmit the corresponding item number with set 'FBBA'.

SOH	F	B	E	-	-	-	r	n	n	n	n	n	n	n	n	n	ETB
-----	---	---	---	---	---	---	---	---	---	---	---	---	---	---	---	---	-----

With this command the printjob identifier which appears in "printing" res. "stopped" window is assigned to a print order. In case only blanks are transmitted, then the printjob identifier is deleted and the display shows "noname".

Initialisation of page handling

SOH	F	B	F	-	-	-	r	ETB
-----	---	---	---	---	---	---	---	-----

Selection of current page

SOH	F	B	G	-	-	-	r	N	ETB
-----	---	---	---	---	---	---	---	---	-----

N: current page number (1...10)

Select order of pages which are to print

SOH	F	B	H	-	-	-	r	P ₁	P ₂	P ₃	ETB
-----	---	---	---	---	---	---	---	----------------	----------------	----------------	-----

P₁; P₂;...= pages which are to print

Generation of page without print start

SOH	F	B	I	-	-	-	r	S	ETB
-----	---	---	---	---	---	---	---	---	-----

With this command the corresponding page is only generated, i.e. no print start signal is sent.

S = 1: sorted (printed are e.g. pages 1-5, then again 1-5 etc.)

S = x: unsorted (printed are x times page 1, then x times page 2, etc.)

Feed**Release a layout feed**

SOH	F	E	-	-	-	-	r	-	-	-	-	-	-	-	-	ETB
-----	---	---	---	---	---	---	---	---	---	---	---	---	---	---	---	-----

Test print**Release a test print**

SOH	F	F	-	-	-	-	r	-	-	-	-	-	-	-	-	ETB
-----	---	---	---	---	---	---	---	---	---	---	---	---	---	---	---	-----

Status print**Parameter set in order to print status report**

SOH	F	C	M	Q	-	-	r	N	-	-	-	-	-	-	-	ETB
-----	---	---	---	---	---	---	---	---	---	---	---	---	---	---	---	-----

N = 0: Print module settings

N = 1: Bar codes

N = 2: Fonts

Cancel print orders**Cancel all active print orders**

SOH	F	G	A	-	-	-	r	N	-	-	-	-	-	-	-	ETB
-----	---	---	---	---	---	---	---	---	---	---	---	---	---	---	---	-----

N = -: Cancel active print orders and delete all label data

N = 1: Cancel active print orders and receive label data

With the execution of this command:

- possible upcoming errors are confirmed
- possible upcoming customised entries are cancelled

Remote console

Set port

SOH	F	C	R	A	-	-	r	N	-	-	-	-	-	-	-	-	ETB
-----	---	---	---	---	---	---	---	---	---	---	---	---	---	---	---	---	-----

N = 0 – Off

N = 1 – COM1

N = 2 – Ethernet

Enquire port

SOH	F	C	R	A	-	-	w	p	p	p	p	p	p	p	p	p	ETB
-----	---	---	---	---	---	---	---	---	---	---	---	---	---	---	---	---	-----

Answer

SOH	A	N	-	-	-	-	-	-	p	p	p	p	p	p	p	p	ETB
-----	---	---	---	---	---	---	---	---	---	---	---	---	---	---	---	---	-----

Set mode

SOH	F	C	R	B	A	-	r	N	N	N	N	-	-	-	-	ETB
-----	---	---	---	---	---	---	---	---	---	---	---	---	---	---	---	-----

N = 0 – on demand

N = 1 – at each changing of display contents

N = 2 – interval

Enquire mode

SOH	F	C	R	B	A	-	w	p	p	p	p	p	p	p	p	p	ETB
-----	---	---	---	---	---	---	---	---	---	---	---	---	---	---	---	---	-----

Answer

SOH	A	N	N	N	N	-	-	-	p	p	p	p	p	p	p	p	ETB
-----	---	---	---	---	---	---	---	---	---	---	---	---	---	---	---	---	-----

Set sending interval of display contents

SOH	F	C	R	B	B	-	r	N	N	N	N	-	-	-	-	ETB
-----	---	---	---	---	---	---	---	---	---	---	---	---	---	---	---	-----

N = 500...5000 – sending interval in ms

Enquire interval of display contents

SOH	F	C	R	B	B	-	w	p	p	p	p	p	p	p	p	p	ETB
-----	---	---	---	---	---	---	---	---	---	---	---	---	---	---	---	---	-----

Answer

SOH	A	N	N	N	N	-	-	-	p	p	p	p	p	p	p	p	ETB
-----	---	---	---	---	---	---	---	---	---	---	---	---	---	---	---	---	-----

Emulation

Set emulation

SOH	F	Z	-	-	-	-	r	N	-	-	-	-	-	-	-	-	ETB
-----	---	---	---	---	---	---	---	---	---	---	---	---	---	---	---	---	-----

N = 0 – CVPL (Carl Valentin Programming Language)

N = 1 – ZPL II[®] (Zebra Programming Language)

Enquire emulation

SOH	F	Z	-	-	-	-	w	p	p	p	p	p	p	p	p	p	ETB
-----	---	---	---	---	---	---	---	---	---	---	---	---	---	---	---	---	-----

Answer

SOH	A	N	-	-	-	-	-	-	p	p	p	p	p	p	p	p	ETB
-----	---	---	---	---	---	---	---	---	---	---	---	---	---	---	---	---	-----

PARAMETER SETS FOR CONTINUOUS MODE

Machine parameters

Set operating mode

SOH	F	C	D	C	-	-	r	N	-	-	-	-	-	-	-	-	ETB
-----	---	---	---	---	---	---	---	---	---	---	---	---	---	---	---	---	-----

N = 1: external I/O static

N = 3: external I/O static continuous

N = 5: external I/O dynamic

N = 6: external I/O dynamic continuous

Enquire operating mode

SOH	F	C	D	C	-	-	w	p	p	p	p	p	p	p	p	p	ETB
-----	---	---	---	---	---	---	---	---	---	---	---	---	---	---	---	---	-----

Answer

SOH	A	N	-	-	-	-	-	-	-	p	p	p	p	p	p	p	p	ETB
-----	---	---	---	---	---	---	---	---	---	---	---	---	---	---	---	---	---	-----

Set print offset

SOH	F	C	A	D	L	A	r	N	N	N	N	N	-	-	M	ETB
-----	---	---	---	---	---	---	---	---	---	---	---	---	---	---	---	-----

NNNN: print offset value

M: unit: 0 = print offset in 1/10 mm (00000...09999)

1 = print offset in 1/10 ms (00000...99999)

Enquire print offset

SOH	F	C	A	D	L	A	w	P	P	p	p	p	p	p	p	p	ETB
-----	---	---	---	---	---	---	---	---	---	---	---	---	---	---	---	---	-----

Answer

SOH	A	N	N	N	N	N	-	-	M	p	p	p	p	p	p	p	p	ETB
-----	---	---	---	---	---	---	---	---	---	---	---	---	---	---	---	---	---	-----

NNNN: print offset value

M: unit: 0 = print offset in 1/10 mm

1 = print offset in 1/10 ms

Set material speed at print start signal

SOH	F	C	A	D	U	D	r	N	-	-	-	-	-	-	-	-	ETB
-----	---	---	---	---	---	---	---	---	---	---	---	---	---	---	---	---	-----

N: 0: Off; 1: On

Enquire material speed at print start signal

SOH	F	C	A	D	U	D	w	p	p	p	p	p	p	p	p	p	ETB
-----	---	---	---	---	---	---	---	---	---	---	---	---	---	---	---	---	-----

Answer

SOH	A	N	-	-	-	-	-	-	-	p	p	p	p	p	p	p	p	ETB
-----	---	---	---	---	---	---	---	---	---	---	---	---	---	---	---	---	---	-----

N: 0: Off; 1: On

Set encoder resolution

SOH	F	C	A	D	U	A	r	N	N	N	N	-	-	-	-	ETB
-----	---	---	---	---	---	---	---	---	---	---	---	---	---	---	---	-----

N: value of encoder resolution (0100...9999)

Enquire encoder resolution

SOH	F	C	A	D	U	A	w	p	p	p	p	p	p	p	p	ETB
-----	---	---	---	---	---	---	---	---	---	---	---	---	---	---	---	-----

Answer

SOH	A	N	N	N	N	-	-	-	-	p	p	p	p	p	p	p	ETB
-----	---	---	---	---	---	---	---	---	---	---	---	---	---	---	---	---	-----

Set material feed per encoder turn

SOH	F	C	A	D	U	B	r	N	N	N	N	-	-	-	-	ETB
-----	---	---	---	---	---	---	---	---	---	---	---	---	---	---	---	-----

N: value of material feed in mm (0010...9999)

Enquire material feed per encoder turn

SOH	F	C	A	D	U	B	w	p	p	p	p	p	p	p	p	ETB
-----	---	---	---	---	---	---	---	---	---	---	---	---	---	---	---	-----

Answer

SOH	A	N	N	N	N	-	-	-	-	p	p	p	p	p	p	p	ETB
-----	---	---	---	---	---	---	---	---	---	---	---	---	---	---	---	---	-----

Enquire material speed

SOH	F	C	A	D	U	C	w	p	p	p	p	p	p	p	ETB
-----	---	---	---	---	---	---	---	---	---	---	---	---	---	---	-----

By means of this command set it is possible to enquire material speed in mm/s. Please note that it is only possible to enquire the value and not to set.

Answer

SOH	A	N	N	N	N	-	-	-	-	p	p	p	p	p	p	p	ETB
-----	---	---	---	---	---	---	---	---	---	---	---	---	---	---	---	---	-----

Ribbon save

Set ribbon save mode

SOH	F	C	D	R	A	-	r	N	-	-	-	-	-	-	-	-	ETB
-----	---	---	---	---	---	---	---	---	---	---	---	---	---	---	---	---	-----

N = 0: Off

N = 1: standard

N = 2: stage 2

N = 3: manually

Enquire ribbon save mode

SOH	F	C	D	R	A	-	w	p	p	p	p	p	p	p	p	p	ETB
-----	---	---	---	---	---	---	---	---	---	---	---	---	---	---	---	---	-----

Answer

SOH	A	N	-	-	-	-	-	-	-	p	p	p	p	p	p	p	ETB
-----	---	---	---	---	---	---	---	---	---	---	---	---	---	---	---	---	-----

Set synchronisation of transfer ribbon and printhead

SOH	F	C	D	R	B	-	r	N	N	N	-	-	-	-	-	ETB
-----	---	---	---	---	---	---	---	---	---	---	---	---	---	---	---	-----

NNN: Value of synchronisation in % (000-100)

Enquire synchronisation of transfer ribbon and printhead

SOH	F	C	D	R	B	-	w	p	p	p	p	p	p	p	p	p	ETB
-----	---	---	---	---	---	---	---	---	---	---	---	---	---	---	---	---	-----

Answer

SOH	A	N	N	N	-	-	-	-	-	p	p	p	p	p	p	p	ETB
-----	---	---	---	---	---	---	---	---	---	---	---	---	---	---	---	---	-----

Set time for printhead move down

SOH	F	C	D	R	C	A	r	N	N	N	N	-	-	-	-	ETB
-----	---	---	---	---	---	---	---	---	---	---	---	---	---	---	---	-----

NNNN: value of time for printhead move down in ms (0000...9999)

Enquire time for printhead move down

SOH	F	C	D	R	C	A	w	p	p	p	p	p	p	p	p	p	ETB
-----	---	---	---	---	---	---	---	---	---	---	---	---	---	---	---	---	-----

Answer

SOH	A	N	N	N	N	-	-	-	-	p	p	p	p	p	p	p	ETB
-----	---	---	---	---	---	---	---	---	---	---	---	---	---	---	---	---	-----

Set feedback distance

SOH	F	C	D	R	F	A	r	N	N	N	N	-	-	-	-	ETB
-----	---	---	---	---	---	---	---	---	---	---	---	---	---	---	---	-----

NNNN: distance in mm

Enquire feedback distance

SOH	F	C	D	R	F	A	w	p	p	p	p	p	p	p	p	p	ETB
-----	---	---	---	---	---	---	---	---	---	---	---	---	---	---	---	---	-----

Answer

SOH	A	N	N	N	N	-	-	-	-	p	p	p	p	p	p	p	ETB
-----	---	---	---	---	---	---	---	---	---	---	---	---	---	---	---	---	-----

Set feedback speed

SOH	F	C	D	R	F	B	r	N	N	N	N	-	-	-	-	ETB
-----	---	---	---	---	---	---	---	---	---	---	---	---	---	---	---	-----

NNNN: feedback speed in mm/s

Enquire feedback speed

SOH	F	C	D	R	F	B	w	p	p	p	p	p	p	p	p	ETB
-----	---	---	---	---	---	---	---	---	---	---	---	---	---	---	---	-----

Answer

SOH	A	N	N	N	N	-	-	-	-	p	p	p	p	p	p	p	ETB
-----	---	---	---	---	---	---	---	---	---	---	---	---	---	---	---	---	-----

Set power of transfer ribbon motor

SOH	F	C	D	R	D	A	r	N	N	N	-	-	-	-	ETB
-----	---	---	---	---	---	---	---	---	---	---	---	---	---	---	-----

NNN: value of transfer ribbon motor power in % (010...200)

Enquire power of transfer ribbon motor

SOH	F	C	D	R	D	A	w	p	p	p	p	p	p	p	p	ETB
-----	---	---	---	---	---	---	---	---	---	---	---	---	---	---	---	-----

Answer

SOH	A	N	N	N	-	-	-	-	-	p	p	p	p	p	p	p	ETB
-----	---	---	---	---	---	---	---	---	---	---	---	---	---	---	---	---	-----

Set brake power for acceleration and braking

SOH	F	C	D	R	E	A	r	N	N	N	-	-	-	-	ETB
-----	---	---	---	---	---	---	---	---	---	---	---	---	---	---	-----

NNN: value of brake power for acceleration and braking in % (000...200)

Enquire brake power for acceleration and braking

SOH	F	C	D	R	E	A	w	p	p	p	p	p	p	p	p	ETB
-----	---	---	---	---	---	---	---	---	---	---	---	---	---	---	---	-----

Answer

SOH	A	N	N	N	-	-	-	-	-	p	p	p	p	p	p	p	ETB
-----	---	---	---	---	---	---	---	---	---	---	---	---	---	---	---	---	-----

Set brake power during printing

SOH	F	C	D	R	E	B	r	N	N	N	-	-	-	-	ETB
-----	---	---	---	---	---	---	---	---	---	---	---	---	---	---	-----

NNN: value of brake power during printing in % (000...200)

Enquire brake power during printing

SOH	F	C	D	R	E	B	w	p	p	p	p	p	p	p	p	ETB
-----	---	---	---	---	---	---	---	---	---	---	---	---	---	---	---	-----

Answer

SOH	A	N	N	N	-	-	-	-	-	p	p	p	p	p	p	p	ETB
-----	---	---	---	---	---	---	---	---	---	---	---	---	---	---	---	---	-----

I/O parameters

Set IN signal level

SOH	F	C	M	D	C	-	r	1	2	3	4	5	6	7	8	ETB
-----	---	---	---	---	---	---	---	---	---	---	---	---	---	---	---	-----

1-8 (inputs 1-8):

- 2 – increased and decreased
- 1 – increased
- 0 – decreased
- s – I/O signal by interface
- x – I/O signal blocked

Enquire signal level

SOH	F	C	M	D	C	-	w	p	p	p	p	p	p	p	p	ETB
-----	---	---	---	---	---	---	---	---	---	---	---	---	---	---	---	-----

Answer

SOH	A	0	1	2	3	4	5	6	7	p	p	p	p	p	p	p	ETB
-----	---	---	---	---	---	---	---	---	---	---	---	---	---	---	---	---	-----

Set OUT signal level

SOH	F	C	M	D	D	-	r	1	2	3	4	5	6	7	8	ETB
-----	---	---	---	---	---	---	---	---	---	---	---	---	---	---	---	-----

1-8 (outputs 1-8):

- 1 – signal level 1
- 0 – signal level 0
- s – I/O signal by interface
- x – I/O signal blocked

Enquire OUT signal level

SOH	F	C	M	D	D	-	w	p	p	p	p	p	p	p	p	ETB
-----	---	---	---	---	---	---	---	---	---	---	---	---	---	---	---	-----

Answer

SOH	A	0	1	2	3	4	5	6	7	p	p	p	p	p	p	p	ETB
-----	---	---	---	---	---	---	---	---	---	---	---	---	---	---	---	---	-----

Set software input

SOH	F	C	M	D	F	-	r	1	2	3	4	5	6	7	8	ETB
-----	---	---	---	---	---	---	---	---	---	---	---	---	---	---	---	-----

1-8 (inputs 1-8):

- 1 – set software input
- 0 – delete software input
- – not considering software input
- p – pulse, execute software input once

Example: Enter a start impulse = FCMDF-rP-----

Enquire current status of software inputs

SOH	F	C	M	D	F	-	w	p	p	p	p	p	p	p	p	ETB
-----	---	---	---	---	---	---	---	---	---	---	---	---	---	---	---	-----

Answer

SOH	A	0	1	2	3	4	5	6	7	p	p	p	p	p	p	p	ETB
-----	---	---	---	---	---	---	---	---	---	---	---	---	---	---	---	---	-----

PARAMETER SETS FOR INTERMITTENT MODE

Machine parameters

Set operating mode

SOH	F	C	A	D	H	-	r	N	-	-	-	-	-	-	-	-	ETB
-----	---	---	---	---	---	---	---	---	---	---	---	---	---	---	---	---	-----

N = 1 – process single items

N = 2 – continuous

Enquire operating mode

SOH	F	C	A	D	H	-	w	p	p	p	p	p	p	p	p	p	ETB
-----	---	---	---	---	---	---	---	---	---	---	---	---	---	---	---	---	-----

Answer

SOH	A	N	-	-	-	-	-	-	-	p	p	p	p	p	p	p	p	ETB
-----	---	---	---	---	---	---	---	---	---	---	---	---	---	---	---	---	---	-----

N: current operating mode

Set print speed

SOH	F	C	A	A	-	-	r	N	N	N	-	-	-	-	-	ETB
-----	---	---	---	---	---	---	---	---	---	---	---	---	---	---	---	-----

NNN: Indication of print speed in mm/s
It is necessary to transmit a 3 digit ASCII number

Enquire speed

SOH	F	C	A	A	-	-	w	p	p	p	p	p	p	p	p	p	ETB
-----	---	---	---	---	---	---	---	---	---	---	---	---	---	---	---	---	-----

Answer

SOH	A	N	N	N	-	-	-	-	-	p	p	p	p	p	p	p	p	ETB
-----	---	---	---	---	---	---	---	---	---	---	---	---	---	---	---	---	---	-----

Set back speed

SOH	F	C	A	D	G	-	r	N	N	N	-	-	-	-	-	ETB
-----	---	---	---	---	---	---	---	---	---	---	---	---	---	---	---	-----

NNN: indication of back speed in mm/s (050...400)

Enquire back speed

SOH	F	C	A	D	G	-	w	p	p	p	p	p	p	p	p	p	ETB
-----	---	---	---	---	---	---	---	---	---	---	---	---	---	---	---	---	-----

Answer

SOH	A	N	N	N	-	-	-	-	-	p	p	p	p	p	p	p	p	ETB
-----	---	---	---	---	---	---	---	---	---	---	---	---	---	---	---	---	---	-----

NNN: current back speed

Set print offset

SOH	F	C	A	D	L	A	r	N	N	N	N	N	-	-	M	ETB
-----	---	---	---	---	---	---	---	---	---	---	---	---	---	---	---	-----

NNNN: print offset in 1/10 mm (0000...9999)

Enquire print offset

SOH	F	C	A	D	L	A	w	P	P	p	p	p	p	p	p	ETB
-----	---	---	---	---	---	---	---	---	---	---	---	---	---	---	---	-----

Answer

SOH	A	N	N	N	N	N	-	-	M	p	p	p	p	p	p	p	ETB
-----	---	---	---	---	---	---	---	---	---	---	---	---	---	---	---	---	-----

NNNN: current print offset

Set ribbon save On/Off

SOH	F	C	D	J	-	-	r	N	-	-	-	-	-	-	-	ETB
-----	---	---	---	---	---	---	---	---	---	---	---	---	---	---	---	-----

N = 0 – Off

N = 1 – On

Enquire ribbon save On/Off

SOH	F	C	D	J	-	-	w	p	p	p	p	p	p	p	p	ETB
-----	---	---	---	---	---	---	---	---	---	---	---	---	---	---	---	-----

Answer

SOH	A	N	-	-	-	-	-	-	p	p	p	p	p	p	p	p	ETB
-----	---	---	---	---	---	---	---	---	---	---	---	---	---	---	---	---	-----

I/O parameters**Set IN signal level**

SOH	F	C	M	D	C	-	r	1	2	3	4	5	6	7	8	ETB
-----	---	---	---	---	---	---	---	---	---	---	---	---	---	---	---	-----

1-8 (inputs 1-8): 2 – increased and decreased
 1 – increased
 0 – decreased
 s – I/O signal by interface
 x – I/O signal blocked

Enquire signal level

SOH	F	C	M	D	C	-	w	p	p	p	p	p	p	p	p	ETB
-----	---	---	---	---	---	---	---	---	---	---	---	---	---	---	---	-----

Answer

SOH	A	0	1	2	3	4	5	6	7	p	p	p	p	p	p	p	ETB
-----	---	---	---	---	---	---	---	---	---	---	---	---	---	---	---	---	-----

Set OUT signal level

SOH	F	C	M	D	D	-	r	1	2	3	4	5	6	7	8	ETB
-----	---	---	---	---	---	---	---	---	---	---	---	---	---	---	---	-----

1-8 (outputs 1-8): 1 – signal level 1
 0 – signal level 0
 s – I/O signal by interface
 x – I/O signal blocked

Enquire OUT signal level

SOH	F	C	M	D	C	-	w	p	p	p	p	p	p	p	p	ETB
-----	---	---	---	---	---	---	---	---	---	---	---	---	---	---	---	-----

Answer

SOH	A	0	1	2	3	4	5	6	7	p	p	p	p	p	p	p	ETB
-----	---	---	---	---	---	---	---	---	---	---	---	---	---	---	---	---	-----

Set I/O protocol port

SOH	F	C	M	D	E	-	r	T	C	P	-	-	-	-	-	ETB
-----	---	---	---	---	---	---	---	---	---	---	---	---	---	---	---	-----

Port: Off
 COM1
 COM2
 TCP

Enquire I/O protocol port

SOH	F	C	M	D	E	-	w	p	p	p	p	p	p	p	p	ETB
-----	---	---	---	---	---	---	---	---	---	---	---	---	---	---	---	-----

Answer

SOH	A	0	1	2	3	-	-	-	-	p	p	p	p	p	p	p	ETB
-----	---	---	---	---	---	---	---	---	---	---	---	---	---	---	---	---	-----

Set software input

SOH	F	C	M	D	F	-	r	1	2	3	4	5	6	7	8	ETB
-----	---	---	---	---	---	---	---	---	---	---	---	---	---	---	---	-----

1-8 (inputs 1-8): 1 – set software input
 0 – delete software input
 - – not considering software input
 p – pulse, execute software input once

Example: Enter a start impulse = FCMDF-rP-----

Enquire current status of software inputs

SOH	F	C	M	D	F	-	w	p	p	p	p	p	p	p	p	ETB
-----	---	---	---	---	---	---	---	---	---	---	---	---	---	---	---	-----

Answer

SOH	A	0	1	2	3	4	5	6	7	p	p	p	p	p	p	p	ETB
-----	---	---	---	---	---	---	---	---	---	---	---	---	---	---	---	---	-----

Set software output

SOH	F	C	M	D	G	-	r	1	2	3	4	5	6	7	8	ETB
-----	---	---	---	---	---	---	---	---	---	---	---	---	---	---	---	-----

1-8 (outputs 1-8): 1 – set software output
 0 – delete software output

Set debounce start signal

SOH	F	C	S	D	C	-	r	N	N	N	-	-	-	-	-	ETB
-----	---	---	---	---	---	---	---	---	---	---	---	---	---	---	---	-----

NNN: debounce time start signal in ms (0...100)

Enquire debounce start signal

SOH	F	C	S	D	C	-	w	p	p	p	p	p	p	p	p	ETB
-----	---	---	---	---	---	---	---	---	---	---	---	---	---	---	---	-----

Answer

SOH	A	N	N	N	-	-	-	-	-	p	p	p	p	p	p	p	ETB
-----	---	---	---	---	---	---	---	---	---	---	---	---	---	---	---	---	-----

Set start signal delay

SOH	F	C	S	D	D	-	r	N	N	N	-	-	-	-	-	ETB
-----	---	---	---	---	---	---	---	---	---	---	---	---	---	---	---	-----

NNN: start signal delay in 1/100 s (0...999)

Enquire start signal delay

SOH	F	C	S	D	D	-	w	p	p	p	p	p	p	p	p	ETB
-----	---	---	---	---	---	---	---	---	---	---	---	---	---	---	---	-----

Answer

SOH	A	N	N	N	-	-	-	-	-	p	p	p	p	p	p	p	ETB
-----	---	---	---	---	---	---	---	---	---	---	---	---	---	---	---	---	-----

Set cancel continuous print (operating mode)

SOH	F	C	S	D	F	A	r	N	-	-	-	-	-	-	-	ETB
-----	---	---	---	---	---	---	---	---	---	---	---	---	---	---	---	-----

N: 0 = Off
1 = On

Enquire cancel continuous print (operating mode)

SOH	F	C	S	D	F	A	w	p	p	p	p	p	p	p	p	ETB
-----	---	---	---	---	---	---	---	---	---	---	---	---	---	---	---	-----

Answer

SOH	A	N	-	-	-	-	-	-	-	p	p	p	p	p	p	p	ETB
-----	---	---	---	---	---	---	---	---	---	---	---	---	---	---	---	---	-----

Set output signal 'print ready' active

SOH	F	C	S	D	J	-	r	N	-	-	-	-	-	-	-	ETB
-----	---	---	---	---	---	---	---	---	---	---	---	---	---	---	---	-----

N: 0 = Off; at print start the 'print ready' signal is inactive.
1 = On; at print start the 'print ready' signal remains active.

Enquire output signal 'print ready' active

SOH	F	C	S	D	J	-	w	p	p	p	p	p	p	p	p	ETB
-----	---	---	---	---	---	---	---	---	---	---	---	---	---	---	---	-----

Answer

SOH	A	N	-	-	-	-	-	-	-	p	p	p	p	p	p	P	ETB
-----	---	---	---	---	---	---	---	---	---	---	---	---	---	---	---	---	-----

N = current setting (see above)

Save configuration permanent

In case you want to save the described settings permanent into the printer, then you have to transmit the following command to the printer.

SOH	F	X	-	-	-	-	r	N	-	-	-	-	-	-	-	-	ETB
N: 0 = save current parameter																	
1 = set all parameters to default values																	

Readout configuration

SOH	F	X	-	-	-	-	w	-	-	-	-	-	-	-	-	-	ETB
-----	---	---	---	---	---	---	---	---	---	---	---	---	---	---	---	---	-----

The printer sends as answer all current settings as parameter sets.

Status enquiry

Host computer can receive information about the printer by the serial interface. The status enquiry has the following data format:

SOH	S	ETB	S = ASCIIs
-----	---	-----	------------

Status return information:

After receiving the status enquiry the printer sends the corresponding status return information.

Data format of status enquiry

SOH	1. Byte								2. Byte								5. - 1. digit	ETB
	8	7	6	5	4	3	2	1	8	7	6	5	4	3	2	1		

1. Byte	=	1. status byte
		8. Bit = free
		7. Bit = always set
		6. Bit = free
		5. Bit = 1 – active print order 0 – no. of pieces = 0 (no print order)
		4. Bit = 1 – stop key activated 0 – stop key not activated
		3. Bit = cutter error 0 – no error; 1 – error
		2. Bit = labels 0 – no error; 1 – error
		1. Bit transfer ribbon 0 – no error; 1 – error
2. Byte	=	2. status byte
		8. Bit = free
		7. Bit = free
		6. Bit = free
		5. Bit = free
		4. Bit = free
		3. Bit = memory card
		2. Bit = mask set
		1. Bit = printhead temperature
5.-1. position	=	number of pieces with 5 digits as ASCII characters min. '00000' / max. '65535'

AUTOSTATUS

The print modules are equipped with an auto status function, i.e. in certain operating modes the print module actively sends the corresponding status. This can be enquired by the serial interface.

To activate the auto status, the host computer has to send the following command to the print module:

SOH	G	1. Byte	2. Byte	ETB
-----	---	---------	---------	-----

Each of the below indicated message which is observed and send by the print module has to be transmitted with a set Bit (see table below 1. Byte and 2. Byte) to the print module via the auto state function. The print module sends after each performed condition the corresponding message (answer) to the host computer.

The following messages are provided:

- 1 Start of generation**
- 2 End of generation**
The print module sends this state in case data for a complete layout was generated. The test print was not taken into consideration.
For counters/date variables the print module sends for each layout a status cycle (start, end).
- 3 Start of printing**
- 4 End of printing**
The start of the print is send in case the generated data is send.
The end of the print is send in case the print of the layout is finished and the motor has stopped.
- 5 Start of cutting**
- 6 End of cutting**
This status describes the cutting. Here it is possible to check the end of the cutting at timeout
→ error.
- 7 Start of feeding**
- 8 End of feeding**
This status is send in case an additional feeding (dispenser, cutter, tear off) is released.
- 9 Start of a print order**
- 10 End of print order**
This status signalises the start and end of a complete print order (1...99999 layouts). This status is active in all operating modes.
- 11 Error**
This status message is send in case an error occurs.
- 12 Printing stopped**
This message is send if the printing is stopped.
- 13 Printing resumed**
This message is send if the printing is resumed.

The print module sends the auto status in the following format to the host computer:

SOH	G	1. Byte	2. Byte	ETB
-----	---	---------	---------	-----

1. Byte

8. Bit	7. Bit	6. Bit	5. Bit	4. Bit	3. Bit	2. Bit	1. Bit
start generating	end generating	start printing	end printing	start cutting	end cutting	start feeding	always 0

2. Byte

8. Bit	7. Bit	6. Bit	5. Bit	4. Bit	3. Bit	2. Bit	1. Bit
end feeding	start print order	end print order	error	free	printing stopped	printing resumed	always 0

Attention: Bit 1 has to be in 1. Byte and 2. Byte always 0, otherwise the print module possibly could recognise SOH or ETB.

At the status message of the print module to the host computer always at least 1 Bit is set. However, it could be occur that several Bits are set at the same time.

At the status demand of the host computer to the print module it is also possible that several Bits are set at the same time.

The auto status demand is saved in the print module, i.e. it is set to 0 after switching off/on. Therefore it is necessary to demand it anew after each time the print module is switched on.

Example:

The print module should observe the start of a print order. For this the host computer sends the following demand to the print module.

SOH	G	00000000	01000000	ETB
-----	---	----------	----------	-----

After the condition is fulfilled (= start of the print order) the print module sends the following message to the host computer:

SOH	G	00000000	01000000	ETB
-----	---	----------	----------	-----

With regard to the contents the answer corresponds always to the format set.

CHARACTER SETS

	Bitmap Fonts														Vector Fonts					
	ID	01	02	03	04	05	07	21	22	23	24	28	29	1/2	3/4	5/6	7/8	9/10	11/12	
		7x9 10x14	10x14 15x21	15x21 22x31	32x45 48x67	15x26 ¹⁾ 22x39 ¹⁾	10x18 ¹⁾ 15x27 ¹⁾	1,0; 13	1,8; 21	2,6; 31	5,6; 67	4,0; 48	0,8; 9	Helvetica Bold	Helvetica Roman	Swiss Light	Basker- ville	Brush Script	Mono- space	
GEM German		2)	2)	2)	2)	2)	2)	2)	2)	2)	2)	2)	2)	2)	2)	2)	2)	2)	2)	
GEM English		2)	2)	2)	2)	2)	2)	2)	2)	2)	2)	2)	2)	2)	2)	2)	2)	2)	2)	
GEM French		2)	2)	2)	2)	2)	2)	2)	2)	2)	2)	2)	2)	2)	2)	2)	2)	2)	2)	
GEM Swedish		2)	2)	2)	2)	2)	2)	2)	2)	2)	2)	2)	2)	2)	2)	2)	2)	2)	2)	
GEM Danish		2)	2)	2)	2)	2)	2)	2)	2)	2)	2)	2)	2)	2)	2)	2)	2)	2)	2)	
CP 437 (German)		2)	2)	2)	2)	2)	2)	2)	2)	2)	2)	2)	2)	2)	2)	2)	2)	2)	2)	
CP 850 (multilingual West European)		2)	2)	2)	2)	2)	2)	2)	2)	2)	2)	2)	2)	2)	2)	2)	2)	2)	2)	
CP 852 (multilingual East European)		5)	5)	5)	5)	5)	5)	5)	5)	5)	5)	5)	5)	6)	6)	6)	6)	6)	6)	
CP1250 (Latin 2; Central European)		3)	3)	3)	3)	3)	3)	3)	3)	3)	3)	3)	3)	2)	2)	6)	6)	6)	2)	
CP1251 (Cyrillic)		6)	6)	6)	6)	6)	6)	6)	6)	6)	6)	6)	6)	4)	4)	6)	6)	6)	4)	
CP1252 ANSI (Latin 1, West European)		2)	2)	2)	2)	2)	2)	2)	2)	2)	2)	2)	2)	2)	2)	2)	2)	2)	2)	
CP1253 (Greek)		6)	6)	6)	6)	6)	6)	6)	6)	6)	6)	6)	6)	4)	4)	6)	6)	6)	4)	
CP1254 (Latin 5, Turkish)		6)	6)	6)	6)	6)	6)	6)	6)	6)	6)	6)	6)	4)	4)	6)	6)	6)	4)	
CP 1257 (Baltic)		6)	6)	6)	6)	6)	6)	6)	6)	6)	6)	6)	6)	4)	4)	6)	6)	6)	4)	
		1) descenders 2) standard 3) at the moment not available, can be replaced by vector fonts (ID3; ID11) 4) on demand, beginning with version 1.41a 5) on demand, only 200 dpi print modules 6) not available																		

Beginning with version 1.41a different character sets were offered but as default the print modules are equipped with Latin 1.

Following languages are supported:

Afrikaans	English	Italian	Serbian
Albanian	Estonian	Latvian	Slovak
Basque	Faeroese	Lithuanian	Slovenian
Belarusian	Finnish	Macedonian (FYROM)	Spanish
Bulgarian	French	Norwegian (Bokmal)	Swahili
Catalan	German	Norwegian (Nynorsk)	Swedish
Croatian	Greek (modern, monotonic)	Polish	Turkish
Czech	Hungarian	Portuguese	Ukrainian
Danish	Icelandic	Romanian	
Dutch	Indonesian	Russian	

Outline of the most important character sets for Central and East European languages

Codepage	Supported languages
1251 (Cyrillic)	Russian, Bearusian, Serbian, Bulgarian, Ukrainian, Macedonian
1250 (Latin 2, Central European)	Romanian, Slovak, Hungarian, Slovenian, Croatian, Serbian, Polish, Czech
852 (multilingual, Eas European)	Polish, Czech, Romanian, Slovak, Hungarian, Slovenian, Croatian, Serbian
1257 (Baltic)	Estonian, Latvian, Lithuanian

International ANSI character font

ANSI	Dec.	HEX	ANSI	Dec.	HEX	ANSI	Dec.	HEX	ANSI	Dec.	HEX	ANSI	Dec.	HEX
SP	32	20	Q	81	51	,	130	82	³	179	B3	ä	228	E4
!	33	21	R	82	52	f	131	83	´	180	B4	å	229	E5
"	34	22	S	83	53	”	132	84	µ	181	B5	æ	230	E6
#	35	23	T	84	54	…	133	85	¶	182	B6	ç	231	E7
\$	36	24	U	85	55	†	134	86	·	183	B7	è	232	E8
%	37	25	V	86	56	‡	135	87	ˆ	184	B8	é	233	E9
&	38	26	W	87	57	‰	136	88	˘	185	B9	ê	234	EA
'	39	27	X	88	58	‰	137	89	°	186	BA	ë	235	EB
(40	28	Y	89	59	Š	138	8A	»	187	BB	ì	236	EC
)	41	29	Z	90	5A	‹	139	8B	¼	188	BC	í	237	ED
*	42	2A	[91	5B	Œ	140	8C	½	189	BD	î	238	EE
+	43	2B	\	92	5C	Ž	141	8D	¾	190	BE	ï	239	EF
,	44	2C]	93	5D	ž	142	8E	¿	191	BF	ð	240	F0
-	45	2D	^	94	5E	ˆ	143	8F	À	192	C0	ñ	241	F1
.	46	2E	_	95	5F	˘	144	90	Á	193	C1	ò	242	F2
/	47	2F	~	96	60	˘	145	91	Â	194	C2	ó	243	F3
0	48	30	a	97	61	’	146	92	Ã	195	C3	ô	244	F4
1	49	31	b	98	62	“	147	93	Ä	196	C4	õ	245	F5
2	50	32	c	99	63	”	148	94	Å	197	C5	ö	246	F6
3	51	33	d	100	64	•	149	95	Æ	198	C6	÷	247	F7
4	52	34	e	101	65	—	150	96	Ç	199	C7	ø	248	F8
5	53	35	f	102	66	—	151	97	È	200	C8	ù	249	F9
6	54	36	g	103	67	™	152	98	É	201	C9	ú	250	FA
7	55	37	h	104	68	š	153	99	Ê	202	CA	û	251	FB
8	56	38	i	105	69	›	154	9A	Ë	203	CB	ü	252	FC
9	57	39	j	106	6A	œ	155	9B	Ì	204	CC	ý	253	FD
:	58	3A	k	107	6B	œ	156	9C	Í	205	CD	ÿ	254	FE
;	59	3B	l	108	6C	ž	157	9D	Î	206	CE	ÿ	255	FF
<	60	3C	m	109	6D	Ž	158	9E	Ï	207	CF			
=	61	3D	n	110	6E	ÿ	159	9F	Ð	208	D0			
>	62	3E	o	111	6F	ı	160	A0	Ñ	209	D1			
?	63	3F	p	112	70	ı	161	A1	Ò	210	D2			
@	64	40	q	113	71	ı	162	A2	Ó	211	D3			
A	65	41	r	114	72	£	163	A3	Ô	212	D4			
B	66	42	s	115	73	¤	164	A4	Õ	213	D5			
C	67	43	t	116	74	¥	165	A5	Ö	214	D6			
D	68	44	u	117	75	¦	166	A6	×	215	D7			
E	69	45	v	118	76	§	167	A7	Ø	216	D8			
F	70	46	w	119	77	¨	168	A8	Ù	217	D9			
G	71	47	x	120	78	©	169	A9	Ú	218	DA			
H	72	48	y	121	79	ª	170	AA	Û	219	DB			
I	73	49	z	122	7A	«	171	AB	Ü	220	DC			
J	74	4A	{	123	7B	¬	172	AC	Ý	221	DD			
K	75	4B		124	7C	-	173	AD	Þ	222	DE			
L	76	4C	}	125	7D	®	174	AE	ß	223	DF			
M	77	4D	~	126	7E	™	175	AF	à	224	E0			
N	78	4E		127	7F	°	176	B0	á	225	E1			
O	79	4F	€	128	80	±	177	B1	â	226	E2			
P	80	50		129	81	²	178	B2	ã	227	E3			

Codepage 437

Dec.	Dec.	Dec.	Dec.	Dec.	
32		81 Q	130 é	179	228
33 !	82 R	131 â	179	229	
34 '	83 S	132 à	180	230 μ	
35 #	84 T	133 à	181	231	
36 \$	85 U	134 à	182	232	
37 %	86 V	135 ç	183	233	
38 &	87 W	136 ê	184	234	
39 '	88 X	137 ë	185	235	
40 (89 Y	138 è	186	236	
41)	90 Z	139 ï	187	237 Ø	
42 *	91 [140 î	188	238	
43 +	92 \	141 ì	189	239	
44 ,	93]	142 Ä	190	240	
45 -	94 ^	143 Å	191	241	
46 .	95 _	144 É	192	242	
47 /	96 `	145 æ	193	243	
48 0	97 a	146 Æ	194	244	
49 1	98 b	147 ô	195	245	
50 2	99 c	148 ö	196	246	
51 3	100 d	149 ò	197	247	
52 4	101 e	150 û	198	248 °	
53 5	102 f	151 ù	199	249	
54 6	103 g	152 ÿ	200	250	
55 7	104 h	153 Ö	201	251	
56 8	105 i	154 Ü	202	252	
57 9	106 j	155 ø	203	253	
58 :	107 k	156 £	204	254	
59 ;	108 l	157 ¥	205	255	
60 <	109 m	158	206		
61 =	110 n	159	207		
62 >	111 o	160 á	208		
63 ?	112 p	161 í	209		
64 @	113 q	162 ó	210		
65 A	114 r	163 ú	211		
66 B	115 s	164 ñ	212		
67 C	116 t	165 Ñ	213 €		
68 D	117 u	166	214		
69 E	118 v	167 °	215		
70 F	119 w	168	216		
71 G	120 x	169	217		
72 H	121 y	170	218		
73 I	122 z	171 ½	219		
74 J	123 {	172 ¼	220		
75 K	124 -	173	221		
76 L	125 }	174 «	222		
77 M	126 ~	175 »	223		
78 N	127	176	224		
79 O	128 Ç	177	225 ß		
80 P	129 ü	178	226		
			227		

Codepage 850

Dec.	Dec.	Dec.	Dec.	Dec.					
32		81	Q	130	é	179		228	ö
33	!	82	R	131	â	180	Á	229	Õ
34	'	83	S	132	à	181	Â	230	μ
35	#	84	T	133	à	182	À	231	
36	\$	85	U	134	å	183	©	232	
37	%	86	V	135	ç	184		233	Ú
38	&	87	W	136	ê	185		234	Û
39	'	88	X	137	ë	186		235	Ü
40	(89	Y	138	è	187		236	
41)	90	Z	139	ï	188	¢	237	
42	*	91	[140	î	189	¥	238	
43	+	92	\	141	ì	190		239	
44	,	93]	142	Ä	191		240	
45	-	94	^	143	Å	192		241	
46	.	95	¯	144	É	193		242	
47	/	96	˘	145	æ	194		243	¾
48	0	97	a	146	Æ	195		244	¶
49	1	98	b	147	ô	196		245	§
50	2	99	c	148	ö	197		246	
51	3	100	d	149	ò	198	ã	247	
52	4	101	e	150	û	199	Ä	248	°
53	5	102	f	151	ù	200		249	
54	6	103	g	152	ÿ	201		250	
55	7	104	h	153	Ö	202		251	
56	8	105	i	154	Ü	203		252	
57	9	106	j	155	ø	204		253	
58	:	107	k	156	£	205		254	
59	:	108	l	157	Ø	206		255	
60	<	109	m	158		207			
61	=	110	n	159		208			
62	>	111	o	160	á	209			
63	?	112	p	161	í	210	Ê		
64	@	113	q	162	ó	211	Ë		
65	A	114	r	163	ú	212	È		
66	B	115	s	164	ñ	213			
67	C	116	t	165	Ñ	214	Í		
68	D	117	u	166		215	Î		
69	E	118	v	167	°	216	Ï		
70	F	119	w	168		217			
71	G	120	x	169	®	218			
72	H	121	y	170		219			
73	I	122	z	171	½	220			
74	J	123	{	172	¼	221			
75	K	124		173		222	Ì		
76	L	125	}	174	«	223			
77	M	126	~	175	»	224	Ó		
78	N	127		176		225	ß		
79	O	128	Ç	177		226	Ò		
80	P	129	ü	178		227	Ö		

Codepage 852*

Dec.	Dec.	Dec.	Dec.	Dec.	
32		81 Q	130 é	179	228 ħ
33 !		82 R	131 â	180	229 ñ
34 '		83 S	132 ä	181 Á	230 Š
35 #		84 T	133 ù	182 Â	231 š
36 \$		85 U	134 ć	183 Ě	232 Ř
37 %		86 V	135 ç	184 Š	233 Ú
38 &		87 W	136 ł	185	234 ř
39 '		88 X	137 ë	186	235 Ů
40 (89 Y	138 Ö	187	236 ý
41)		90 Z	139 õ	188	237 Ÿ
42 *		91 [140 î	189 Ž	238 ŧ
43 +		92 \	141 ě	190 ž	239 '
44 ,		93]	142 Ā	191	240 -
45 -		94 ^	143 Ć	192	241 '
46 .		95 _	144 Ę	193	242
47 /		96 `	145 Ĺ	194	243 -
48 0		97 a	146 Í	195	244 -
49 1		98 b	147 ô	196	245 §
50 2		99 c	148 ö	197	246 ÷
51 3		100 d	149 Ł	198 Ą	247 ˚
52 4		101 e	150 ł	199 ą	248 ˚
53 5		102 f	151 Ś	200	249 ..
54 6		103 g	152 ś	201	250 .
55 7		104 h	153 Ő	202	251 ũ
56 8		105 i	154 Ű	203	252 Ŕ
57 9		106 j	155 Ť	204	253 ř
58 :		107 k	156 t	205	254
59 ;		108 l	157 Ł	206	255
60 <		109 m	158 x	207	
61 =		110 n	159 č	208 đ	
62 >		111 o	160 á	209 Đ	
63 ?		112 p	161 í	210 Ď	
64 @		113 q	162 ó	211 Ě	
65 A		114 r	163 ú	212 d	
66 B		115 s	164 ą	213 Ń	
67 C		116 t	165 Ź	214 í	
68 D		117 u	166 ž	215 î	
69 E		118 v	167 ě	216 ě	
70 F		119 w	168 Ę	217	
71 G		120 x	169 ę	218	
72 H		121 y	170	219	
73 I		122 z	171 ź	220	
74 J		123 {	172 Ć	221 T	
75 K		124 128	173 §	222 U	
76 L		125 129	174 «	223	
77 M		126 ~	175 »	224 Ó	
78 N		127 Δ	176	225 ß	
79 O		128 Ç	177	226 Ñ	
80 P		129 Ů	178	227 Ñ	

* option

Codepage 857*

Dec.	Dec.	Dec.	Dec.	Dec.					
32		81	Q	130	é	179		228	ø
33	!	82	R	131	â	180		229	Ö
34	'	83	S	132	ä	181	Á	230	μ
35	#	84	T	133	à	182	Ă	231	R
36	\$	85	U	134	â	183	À	232	μ
37	%	86	V	135	ç	184	©	233	Û
38	&	87	W	136	ê	185		234	Û
39	'	88	X	137	ë	186		235	Û
40	(89	Y	138	è	187		236	ì
41)	90	Z	139	ï	188		237	ÿ
42	*	91	[140	î	189	¢	238	
43	+	92	\	141	ı	190	¥	239	'
44	,	93]	142	Ä	191		240	-
45	-	94	^	143	Å	192		241	±
46	.	95	_	144	É	193		242	
47	/	96	`	145	æ	194		243	¼
48	0	97	a	146	Æ	195		244	¶
49	1	98	b	147	ô	196		245	§
50	2	99	c	148	ö	197		246	÷
51	3	100	d	149	ò	198	ã	247	˙
52	4	101	e	150	û	199	Ä	248	˚
53	5	102	f	151	ù	200		249	˚
54	6	103	g	152	Ï	201		250	˚
55	7	104	h	153	Ö	202		251	˚
56	8	105	i	154	Ü	203		252	˚
57	9	106	j	155	ø	204		253	˚
58	:	107	k	156	£	205		254	˚
59	;	108	l	157	Ø	206		255	˚
60	<	109	m	158	Ş	207			
61	=	110	n	159	ş	208	°		
62	>	111	o	160	á	209	a		
63	?	112	p	161	í	210	Ê		
64	@	113	q	162	ó	211	Ë		
65	A	114	r	163	ú	212	È		
66	B	115	s	164	ñ	213	Ë		
67	C	116	t	165	Ñ	214	İ		
68	D	117	u	166	Ğ	215	ı		
69	E	118	v	167	ğ	216	ï		
70	F	119	w	168	ı	217			
71	G	120	x	169	®	218			
72	H	121	y	170		219			
73	I	122	z	171	½	220			
74	J	123	{	172	¼	221			
75	K	124		173	ı	222			
76	L	125	}	174	«	223			
77	M	126	~	175	»	224	Ó		
78	N	127	△	176		225	ß		
79	O	128	Ç	177		226	Ò		
80	P	129	ü	178		227	Ö		

* option

GEM German

Dec.	Dec.	Dec.	Dec.	Dec.
32		81 Q	130 é	179 ¢
33 !		82 R	131 â	180 œ
34 '		83 S	132 ä	181 Œ
35 #		84 T	133 à	182 À
36 \$		85 U	134 â	183 Ã
37 %		86 V	135 ç	184 Ö
38 &		87 W	136 ê	185 §
39 '		88 X	137 ë	186 ?
40 (89 Y	138 è	187 †
41)		90 Z	139 ĩ	188 ¶
42 *		91 Ä	140 î	189 ©
43 +		92 Ö	141 ï	190 ®
44 ,		93 Ü	142 Ä	191 ™
45 -		94 \	143 Å	192
46 .		95 ¯	144 É	193 ...
47 /		96 ˇ	145 æ	194 ‰
48 0		97 a	146 Æ	195 •
49 1		98 b	147 ô	196 —
50 2		99 c	148 ö	197 –
51 3		100 d	149 ò	198 °
52 4		101 e	150 û	199 Á
53 5		102 f	151 ù	200 Â
54 6		103 g	152 ÿ	201 Ê
55 7		104 h	153 Ö	202 È
56 8		105 i	154 Ü	203 Ě
57 9		106 j	155 ø	204 ì
58 :		107 k	156 £	205 í
59 ;		108 l	157 Ø	206 î
60 <		109 m	158 ~	207 ï
61 =		110 n	159 –	208 Ò
62 >		111 o	160 á	209 Ó
63 ?		112 p	161 í	210 Ô
64 @		113 q	162 ó	211
65 A		114 r	163 ú	212
66 B		115 s	164 ñ	213 Ù
67 C		116 t	165 Ñ	214 Ú
68 D		117 u	166	215 Û
69 E		118 v	167	216 Ÿ
70 F		119 w	168	217
71 G		120 x	169 '	218
72 H		121 y	170 ”	219
73 I		122 z	171 ‹	220
74 J		123 ä	172 ›	221
75 K		124 ö	173	222
76 L		125 ü	174 «	223 μ
77 M		126 ß	175 »	224 \
78 N		127 °	176 ã	225 ß
79 O		128 Ç	177 õ	226
80 P		129 ù	178 ¥	227
				228 €
				229
				230 μ
				231
				232
				233
				234
				235
				236
				237 Ø
				238
				239
				240
				241
				242
				243
				244
				245
				246
				247
				248 °
				249
				250
				251 ¹
				252 º
				253 ¸
				254
				255

GEM English

Dec.	Dec.	Dec.	Dec.	Dec.
32		81 Q	130 é	179 ¢
33 !		82 R	131 â	180 œ
34 '		83 S	132 à	181 Œ
35 #		84 T	133 à	182 À
36 \$		85 U	134 â	183 Ã
37 %		86 V	135 ç	184 Ö
38 &		87 W	136 ê	185 §
39 '		88 X	137 ë	186 ?
40 (89 Y	138 è	187 †
41)		90 Z	139 ï	188 ¶
42 *		91 Ä	140 î	189 ©
43 +		92 -	141 ì	190 ®
44 ,		93 Ü	142 Ä	191 ™
45 -		94 ¼	143 Å	192 —
46 .		95 `	144 É	193 ...
47 /		96 `	145 æ	194 ‰
48 0		97 a	146 Æ	195 •
49 1		98 b	147 ô	196 —
50 2		99 c	148 ö	197 —
51 3		100 d	149 ò	198 °
52 4		101 e	150 û	199 Á
53 5		102 f	151 ù	200 Â
54 6		103 g	152 ÿ	201 Ê
55 7		104 h	153 Ö	202 È
56 8		105 i	154 Ü	203 È
57 9		106 j	155 ø	204 ì
58 :		107 k	156 £	205 í
59 ;		108 l	157 Ø	206 î
60 <		109 m	158 ~	207 ï
61 =		110 n	159 —	208 Ò
62 >		111 o	160 á	209 Ó
63 ?		112 p	161 í	210 Ô
64 £		113 q	162 ó	211
65 A		114 r	163 ú	212
66 B		115 s	164 ñ	213 Ù
67 C		116 t	165 Ñ	214 Ú
68 D		117 u	166 ¼	215 Û
69 E		118 v	167 ½	216 Ÿ
70 F		119 w	168 ¾	217
71 G		120 x	169 '	218
72 H		121 y	170 "	219
73 I		122 z	171 <	220
74 J		123 ä	172 >	221
75 K		124 ö	173	222
76 L		125 ü	174 «	223 μ
77 M		126 ¾	175 »	224 \
78 N		127 Ç	176 ã	225 ß
79 O		128 Ç	177 õ	226
80 P		129 ü	178 ¥	227
				228 €
				229
				230 μ
				231
				232
				233
				234
				235
				236
				237 Ø
				238
				239
				240
				241
				242
				243
				244
				245
				246
				247
				248 °
				249
				250
				251
				252
				253
				254
				255

GEM French

Dec.	Dec.	Dec.	Dec.	Dec.					
32		81	Q	130	é	179	¢	228	€
33	!	82	R	131	â	180	œ	229	
34	'	83	S	132	à	181	Œ	230	μ
35	#	84	T	133	à	182	À	231	
36	\$	85	U	134	â	183	Ã	232	
37	%	86	V	135	ç	184	Ö	233	
38	&	87	W	136	ê	185	§	234	
39	'	88	X	137	ë	186	?	235	
40	(89	Y	138	è	187	†	236	
41)	90	Z	139	ï	188	‡	237	∅
42	*	91	ô	140	î	189	©	238	
43	+	92	ç	141	ì	190	®	239	
44	,	93	Û	142	Ä	191	™	240	
45	-	94	¼	143	Å	192	—	241	
46	.	95	½	144	É	193	...	242	
47	/	96	¾	145	æ	194	‰	243	
48	0	97	a	146	Æ	195	•	244	
49	1	98	b	147	ô	196	—	245	
50	2	99	c	148	ö	197	—	246	
51	3	100	d	149	ò	198	°	247	
52	4	101	e	150	û	199	Á	248	°
53	5	102	f	151	ù	200	Â	249	
54	6	103	g	152	ÿ	201	È	250	
55	7	104	h	153	Ö	202	Ê	251	
56	8	105	i	154	Ü	203	Ë	252	
57	9	106	j	155	ø	204	Ì	253	
58	:	107	k	156	£	205	Í	254	
59	:	108	l	157	∅	206	Î	255	
60	<	109	m	158	~	207	Ï		
61	=	110	n	159	—	208	Ò		
62	>	111	o	160	á	209	Ó		
63	?	112	p	161	í	210	Ô		
64	à	113	q	162	ó	211			
65	A	114	r	163	ú	212			
66	B	115	s	164	ñ	213	Ù		
67	C	116	t	165	Ñ	214	Ú		
68	D	117	u	166	¼	215	Û		
69	E	118	v	167	½	216	Ü		
70	F	119	w	168	¾	217	Ÿ		
71	G	120	x	169	'	218			
72	H	121	y	170	"	219			
73	I	122	z	171	<	220			
74	J	123	é	172	>	221			
75	K	124	ñ	173		222			
76	L	125	è	174	«	223	μ		
77	M	126	ß	175	»	224	\		
78	N	127	°	176	ã	225	ß		
79	O	128	Ç	177	ö	226			
80	P	129	ü	178	¥	227			

GEM Swedish

Dec.	Dec.	Dec.	Dec.	Dec.					
32		81	Q	130	é	179	¢	228	€
33	!	82	R	131	â	180	œ	229	
34	'	83	S	132	à	181	Œ	230	μ
35	#	84	T	133	à	182	À	231	
36	\$	85	U	134	â	183	Ã	232	
37	%	86	V	135	ç	184	Ö	233	
38	&	87	W	136	ê	185	§	234	
39	'	88	X	137	ë	186	?	235	
40	(89	Y	138	è	187	†	236	
41)	90	Z	139	ï	188	‡	237	∅
42	*	91	Ä	140	î	189	©	238	
43	+	92	Ö	141	ì	190	®	239	
44	,	93	À	142	Ä	191	™	240	
45	-	94	Ü	143	Å	192	—	241	
46	.	95	_	144	É	193	...	242	
47	/	96	é	145	æ	194	‰	243	
48	0	97	a	146	Æ	195	•	244	
49	1	98	b	147	ô	196	—	245	
50	2	99	c	148	ö	197	—	246	
51	3	100	d	149	ò	198	°	247	
52	4	101	e	150	û	199	Á	248	°
53	5	102	f	151	ù	200	Â	249	
54	6	103	g	152	ÿ	201	È	250	
55	7	104	h	153	Ö	202	Ë	251	
56	8	105	i	154	Ü	203	Ë	252	
57	9	106	j	155	ø	204	Ì	253	
58	:	107	k	156	£	205	Í	254	
59	:	108	l	157	Ø	206	Î	255	
60	<	109	m	158	~	207	Ï		
61	=	110	n	159	—	208	Ò		
62	>	111	o	160	á	209	Ó		
63	?	112	p	161	í	210	Ô		
64	@	113	q	162	ó	211			
65	A	114	r	163	ú	212			
66	B	115	s	164	ñ	213	Ù		
67	C	116	t	165	Ñ	214	Ú		
68	D	117	u	166	¼	215	Û		
69	E	118	v	167	½	216	ÿ		
70	F	119	w	168	¾	217			
71	G	120	x	169	'	218			
72	H	121	y	170	"	219			
73	I	122	z	171	<	220			
74	J	123	ä	172	>	221			
75	K	124	ö	173		222			
76	L	125	å	174	«	223	μ		
77	M	126	ü	175	»	224	\		
78	N	127	°	176	ã	225	ß		
79	O	128	Ç	177	õ	226			
80	P	129	ü	178	¥	227			

GEM Danish

Dec.	Dec.	Dec.	Dec.	Dec.					
32		81	Q	130	é	179	¢	228	€
33	!	82	R	131	â	180	œ	229	
34	'	83	S	132	à	181	Œ	230	μ
35	#	84	T	133	à	182	À	231	
36	\$	85	U	134	â	183	Ã	232	
37	%	86	V	135	ç	184	Ö	233	
38	&	87	W	136	ê	185	§	234	
39	'	88	X	137	ë	186	?	235	
40	(89	Y	138	è	187	†	236	
41)	90	Z	139	ï	188	‡	237	∅
42	*	91	Æ	140	î	189	©	238	
43	*	92	Ø	141	ì	190	®	239	
44	,	93	Å	142	Ä	191	™	240	
45	—	94	Ö	143	Å	192	—	241	
46	.	95	—	144	É	193	...	242	
47	/	96	—	145	æ	194	‰	243	
48	0	97	a	146	Æ	195	•	244	
49	1	98	b	147	ô	196	—	245	
50	2	99	c	148	ö	197	—	246	
51	3	100	d	149	ò	198	°	247	
52	4	101	e	150	û	199	Á	248	°
53	5	102	f	151	ù	200	Â	249	
54	6	103	g	152	ÿ	201	È	250	
55	7	104	h	153	Ö	202	Ë	251	
56	8	105	i	154	Ü	203	Ë	252	
57	9	106	j	155	ø	204	Ì	253	
58	:	107	k	156	£	205	Í	254	
59	:	108	l	157	Ø	206	Î	255	
60	<	109	m	158	~	207	Ï		
61	=	110	n	159	—	208	Ò		
62	>	111	o	160	á	209	Ó		
63	?	112	p	161	í	210	Ô		
64	ä	113	q	162	ó	211			
65	A	114	r	163	ú	212			
66	B	115	s	164	ñ	213	Ù		
67	C	116	t	165	Ñ	214	Ú		
68	D	117	u	166	¼	215	Û		
69	E	118	v	167	½	216	ÿ		
70	F	119	w	168	¾	217			
71	G	120	x	169	'	218			
72	H	121	y	170	"	219			
73	I	122	z	171	<	220			
74	J	123	æ	172	>	221			
75	K	124	ø	173		222			
76	L	125	å	174	«	223	μ		
77	M	126	Û	175	»	224	\		
78	N	127	°	176	ã	225			
79	O	128	Ç	177	õ	226	ß		
80	P	129	ü	178	¥	227			

FONT EXAMPLES

Bitmap fonts (not proportional)

Font 01 (8 x 11) ratio 3:3
 Font 02 (12 x 17) ratio 3:3
 Font 03 (18 x 26) ratio 2:2
 Font 04 (40 x 56) ratio 1:1
 Font 05 (18 x 32 with descender) ratio 2:2
 Font 07 (12 x 22 with descender) ratio 2:2

Bitmap fonts (proportional)

Font 21 (10 proportional) ratio 3:3
 Font 22 (18 proportional) ratio 2:2
 Font 23 (26 proportional) ratio 2:2
 Font 24 (56 proportional) ratio 1:1
 Font 28 (40 proportional) ratio 1:1
 Font 29 (8 proportional) ratio 5:5

Vector fonts

Absender (Baskerville) Das ist ein Musteretikett
 für die Darstellung der
Gold, Petra (Swiss Light) Schriftarten (Monospace)
 Name, Vorname (Helvetica Bold)
Goldstraße 456 (Swiss Light)
 Straße, Hausnummer (Helvetica Bold)
23456 Golddorf (Swiss Light)
 PLZ, Ort (Helvetica Bold)

Musterlieferung
Bitte bestätigen Sie
den Empfang. (Brush Script)

Empfänger (Baskerville)
Mustermann, Max (Helvetica Roman)
 Name, Vorname (Helvetica Bold)
Musterstraße 123 (Helvetica Roman)
 Straße, Hausnummer (Helvetica Bold)
45678 Musterstadt (Helvetica Roman)
 PLZ, Ort (Helvetica Bold)

INDEX

A

ANSI, character set	88
Auto status.....	84
Aztec Code, mask set.....	23

B

Back speed (intermittent mode), parameter set	79
Bar code	
Mask set.....	14
Rotation.....	6
Bitmap fonts, font examples	98
Brake power (continuous mode), parameter set	76
Buzzer, parameter set	52

C

Cancel continuous print (parameter set)	
Continuous mode.....	78
Intermittent mode.....	82
Character sets	
ANSI.....	88
Codepage 437	89
Codepage 850	90
Codepage 852	91
Codepage 857	92
GEM Danish.....	97
GEM English.....	94
GEM French.....	95
GEM German.....	93
GEM Swedish	96
General information	86
Check digit	
Variable definition	44
CODABLOCK F, mask set	20
Codepage 437, character set	89
Codepage 850, character set	90
Codepage 852, character set	91
Codepage 857, character set	92
Codepage, parameter set.....	51
Columns	
Number, parameter set.....	47
Width, parameter set.....	48
Compact Flash card	
Change directory.....	68
Create directory	68
Delete directory.....	68
Delete label	67
Format.....	67
Free memory space	67
Load label	67
Standard directory via I/O	68
Transfer file from printer.....	69
Compressed air (sensors), parameter set.....	59
Configuration	
Readout	83
Save permanent.....	83
Connector assignment RS485/RS422, serial data transmission	3

Continuous mode (parameter sets)	
Brake power	76
Cancel continuous print	78
Check material speed at print start	73
Encoder resolution	74
Feedback distance	75
Feedback speed	76
IN signal level	77
Material feed/encoder turn	74
Material speed	74
Operating mode	73
OUT signal level	77
Output signal 'print ready' active	78
Print offset	73
Printhead time	75
Ribbon save mode	75
Software input	77
Software output	78
Start signal delay	78
Synchronisation	75
Transfer ribbon motor power	76
Contrast, parameter set	47
Counter (extended), variables	33
Counter, variables	32
Cover condition (sensors), parameter set	59
Currency, variable	38
D	
Data format	
Explanation	8
General information	7
Data memory, parameter set	55
DataMatrix, mask set	18
Date/time	
Date	63
Summer/wintertime	64
Summertime begin	65
Summertime end	65
Time	63
time shifting	65
Variable	34
Datumpoint, setting	6
Debounce start signal (intermittent mode), parameter set	82
Default layout On/Off, parameter set	53
Device parameters	
Buzzer	52
Codepage	51
Default layout On/Off	53
External print parameters	51
Field handling	50
Hotstart	53
Keyboard layout	52
Label change confirmation	53
Operating mode	50
Print after measuring	53
Print module language	51
Print position	50
Transfer ribbon control	50
User guiding	52

DHCP support, parameter set	57
Directory (Compact Flash card)	
Change, parameter set	68
Create, parameter set	68
Delete, parameter set	68
E	
Emulation, parameter set	72
Encoder resolution (continuous mode), parameter set	74
EPC calculation	
Variable definition	43
Error (readout)	
ID, parameter set	69
Text, parameter set	69
Error (reset), parameter set	69
ETB, parameter set	54
Example	
Graphic, PCX format	30
Mask set	27
Text set	27
External print parameters, parameter set	51
F	
Feed, parameter set	71
Feedback	
Distance (continuous mode), parameter set	75
Speed (continuous mode), parameter set	76
Field attributes/properties, definition	9
Field handling, parameter set	50
Field names, definition	10
Flip layout, parameter set	48
Font examples	
Bitmap fonts (not proportional)	98
Bitmap fonts (proportional)	98
Vector fonts	98
Format (Compact Flash card), parameter set	67
Free memory space (Compact Flash card), parameter set	67
Function group (password), parameter set	66
G	
Gateway address (network), parameter set	56
GEM Danish, character set	97
GEM English, character set	94
GEM French, character set	95
GEM German, character set	93
GEM Swedish, character set	96
Graphic	
General format	28
Internal, mask set	25
PCX format, example	30
PCX format, general information	29
Rotation	6
GS1 DataBar (RSS), mask set	21
GS1 DataMatrix, mask set	19
GS1-128 Parser	
Variable definition	42
H	
Hotstart, parameter set	53

I

I/O parameters (continuous mode)	
Continuous print.....	78
IN signal level.....	77
OUT signal level.....	77
Software input.....	77
Software output.....	78
Start signal delay.....	78
I/O parameters (intermittent mode)	
Cancel continuous print.....	82
Debounce start signal.....	82
I/O protocol port.....	81
IN signal level.....	80
OUT signal level.....	81
Output signal 'print ready' active.....	78, 82
Software input.....	81
Software output.....	81
Start signal delay.....	82
I/O protocol port (intermittent mode), parameter set.....	81
IN signal level (parameter set)	
Continuous mode).....	77
Intermittent mode.....	80
Interface	
All interface parameters.....	54
Date memory.....	55
Interface protocol.....	54
Port transmission.....	55
SOH/ETB.....	54
Unknown interrogative set, reaction.....	55
Intermittent mode (parameter sets)	
Back speed.....	79
Cancel continuous print.....	82
Debounce start signal.....	82
I/O protocol port.....	81
IN signal level.....	80
Operating mode.....	79
OUT signal level.....	81
Output signal 'print ready' active.....	82
Print offset.....	80
Print speed.....	79
Ribbon save.....	80
Software impulse.....	81
Software output.....	81
Start signal delay.....	82
Interrogative sets (unknown), reaction.....	55
IP address (network), parameter set.....	56
ITF 14, mask set.....	15

K

Keyboard layout, parameter set.....	52
-------------------------------------	----

L

Label parameters	
Flip/rotate label.....	49
Labels	
Delete (Compact Flash card), parameter set.....	67
Load (Compact Flash card), parameter set.....	67
Layout change confirmation, parameter set.....	53

Layout parameters	
Column width	48
Contrast	47
Flip layout.....	48
Layout alignment.....	47
Layout length in 1/100 mm	46
Layout width in 1/100 mm.....	46
Layouts/cycle	46
Material selection	47
Number of columns.....	47
Printing lines	48
Rotate layout.....	48
Layouts	
Alignment, parameter set.....	47
Length in 1/100 mm, parameter set.....	46
Width in 1/100 mm, parameter set.....	46
Layouts/cycle, parameter set	46
Line, mask set	24
Lines (number), parameter set.....	48
Link field, variables	31
M	
MAC address (network), parameter set	57
Machine parameters (continuous mode)	
Encoder resolution	74
Material feed	74
Material speed	73, 74
Operating mode	73
Print offset.....	73
Machine parameters (intermittent mode)	
Back speed	79
Operating mode	79
Print offset.....	80
Print speed.....	79
Ribbon save	80
Mask set	
Aztec Code	23
Bar code.....	14
CODABLOCK F	20
DataMatrix.....	18
Example	27
Graphic internal.....	25
GS1 DataBar (RSS).....	21
GS1 DataMatrix	19
ITF 14.....	15
Line	24
MAXICODE	17
PDF417	16
QR Code	22
Rectangle	24
Text	13
Material	
Feed per encoder turn (continuous mode), parameter set.....	74
Selection, parameter set.....	47
Speed (continuous mode), parameter set	74
Speed at print start signal (continuous mode), parameter set.....	73
MAXICODE, mask set	17

Memory card data	
Variable definition	42
Mileage	
Print module, parameter set	62
Printhead, parameter set	62
Mode (remote console), parameter set	72
Mode selection, parameter set	50
N	
Netmask (network), parameter set	56
Network	
DHCP support	57
Gateway address	56
IP address	56
MAC address	57
Netmask	56
NTP Server IP	58
NTP status	58
Printer name	57
Reset network device	58
Time zone (hour offset)	58
Transmission mode	57
NTP Server IP (network), parameter set	58
NTP status (network), parameter set	58
O	
Offset X, parameter set	46
Online/offline, parameter set	60
Operating mode (parameter sets)	
Continuous mode	73
Intermittent mode	79
OUT signal level (parameter set)	
Continuous mode	77
Intermittent mode	81
Output signal 'print ready' active (parameter set)	
Continuous mode	78
Intermittent mode	82
P	
Parallel data transmission	
Connection	5
General information	4
Parameter set	
Date/time	63
Test print	71
Parameter sets	
Cancel print orders	71
Compact Flash card	67
Continuous mode	73
Device parameters	50
Emulation	72
Error ID, readout	69
Error text, readout	69
Feed	71
Interface	54
Layout parameters	46
Machine parameters (intermittent mode)	79
Network (option)	56
Password	66

Quantity (print order).....	70
Remote console.....	72
Reset error.....	69
Service functions.....	60
Start printing.....	71
Start/stop command.....	69
Status print.....	71
Password	
Function group.....	66
Password.....	66
PDF417, mask set.....	16
Port transmission, parameter set.....	55
Print after measuring, parameter set.....	53
Print module language, parameter set.....	51
Print offset (parameter set)	
Continuous mode.....	73
Intermittent mode.....	80
Print orders (cancel), parameter set.....	71
Print position, parameter set.....	50
Print speed (intermittent mode), parameter set.....	79
Print start, parameter set.....	71
Printer name (network), parameter set.....	57
Printhead	
Resistance, parameter set.....	61
Temperature, parameter set.....	61
Printhead time (continuous mode), parameter set.....	75
Q	
QR Code, mask set.....	22
Quantity (print order), parameter set.....	70
R	
Readout, configuration.....	83
Rectangle, mask set.....	24
Remote console	
Interface.....	72
Mode.....	72
Sending interval (display contents).....	72
Reprint action, parameter set.....	60
Reset network device (network), parameter set.....	58
Ribbon save (intermittent mode), parameter set.....	80
Ribbon save mode (continuous mode)	
Brake power.....	76
Feedback distance.....	75
Feedback speed.....	76
Printhead move down time.....	75
Ribbon save mode.....	75
Synchronisation.....	75
Transfer ribbon motor power.....	76
Rotate layout, parameter set.....	48
Rotation	
Bar code.....	6
Graphic.....	6
Text.....	6
RS232	
assignment, cable.....	2
hardware handshake.....	2

S

Save permanent, configuration	83
Sending interval (display contents), parameter set	72
Sensors	
Compressed air	59
Cover condition	59
Serial data transmission	
Connection RS232	2
Connector assignment RS485/RS422	3
Connector assignment, DSUB socket	1
Xon/Xoff protocol	1
Service functions	
Mileage, print module	62
Mileage, printhead	62
Online/offline	60
Printhead open/closed	60
Printhead open/closed, parameter set	60
Printhead resistance	61
Printhead temperature	61
Reprint action	60
Transfer ribbon length	61
Transfer ribbon prior warning	61
Shift variable, variables	39
Software (continuous mode)	
Software input	77
Software output	78
Software (intermittent mode)	
Software input	81
Software output	81
SOH, parameter set	54
Standard directory, set via I/O	68
Start signal delay (continuous mode), parameter set	78
Start signal delay (intermittent mode), parameter set	82
Start/stop command, parameter set	69
Status	
Enquiry, data format	83
Print, parameter set	71
Return information, data format	83
Substring	
Variable definition	45
Summer/wintertime (parameter sets)	
Automatical adjustment	64
Summertime begin	65
Summertime end	65
Time shifting	65
Synchronisation (continuous mode), parameter set	75

T

Test print, parameter set	71
Text	
Mask set	13
Rotation	6
Set, example	27
Set, general information	26
Time zone (Network), parameter set	58
Time, parameter set	63
Transfer file from printer (Compact Flash card), parameter set	69

Transfer ribbon (parameter sets)	
Control.....	50
Length.....	61
Motor power (continuous mode), parameter set.....	76
Prior warning.....	61
Prior warning diameter.....	61
Transmission mode (network), parameter set.....	57
U	
User guiding	
Parameter set.....	52
Variable definition.....	40
User guiding with mask	
Variable definition.....	41
V	
Variables	
Check digit.....	44
Counter.....	32
Currency variable.....	38
Date/Time.....	34
EPC calculation.....	43
Extended counter.....	33
GS1-128 Parser.....	42
Link field.....	31
Memory card data.....	42
Shift variable.....	39
Substring.....	45
Text structure.....	31
User guiding.....	40
User guiding with mask.....	41
Vector fonts, font examples.....	98
X	
X displacement (offset 3), parameter set.....	46



Carl Valentin GmbH
Neckarstraße 78 – 86 u. 94 . 78056 Villingen-Schwenningen
Phone +49 (0)7720 9712-0 . Fax +49 (0)7720 9712-9901
info@carl-valentin.de . www.carl-valentin.de