

DYNACODE

Quick Reference Guide
Central Europe





Carl Valentin GmbH

Postfach 3744
78026 Villingen-Schwenningen
Neckarstraße 78 – 86 u. 94
78056 Villingen-Schwenningen

Phone +49 (0)7720 9712-0
Fax +49 (0)7720 9712-9901

E-Mail info@carl-valentin.de
Internet www.carl-valentin.de

DE - DEUTSCH	5
ES - ESPAÑOL	33
FR - FRANÇAIS	61
GB - ENGLISH	89
IT - ITALIANO	117
PT - PORTUGUESE	145
TR - TÜRKÇE	173

Kurzanleitung und Hinweise zur
Produktsicherheit

Deutsch

Copyright by Carl Valentin GmbH.

Angaben zu Lieferumfang, Aussehen, Leistung, Maßen und Gewicht entsprechen unseren Kenntnissen zum Zeitpunkt der Drucklegung.

Änderungen sind vorbehalten.

Kein Teil des Werks darf in irgendeiner Form (Druck, Fotokopie oder einem anderen Verfahren) ohne schriftliche Genehmigung von Carl Valentin GmbH reproduziert oder unter Verwendung elektronischer Systeme verarbeitet, vervielfältigt oder verbreitet werden.

Durch die ständige Weiterentwicklung der Geräte können evtl. Abweichungen zwischen der Dokumentation und dem Gerät auftreten. Die aktuelle Version ist unter www.carl-valentin.de zu finden.

Warenzeichen

Alle genannten Marken oder Warenzeichen sind eingetragene Marken oder eingetragene Warenzeichen ihrer jeweiligen Eigentümer und ggf. nicht gesondert gekennzeichnet. Aus dem Fehlen der Kennzeichnung kann nicht geschlossen werden, dass es sich nicht um eine eingetragene Marke oder ein eingetragenes Warenzeichen handelt.

Direktdruckwerke der Carl Valentin GmbH erfüllen folgende Sicherheitsrichtlinien:

- CE** EG-Maschinenrichtlinie (98/37/EG)
- EG-Niederspannungsrichtlinie (2006/95/EG)
- EG-Richtlinie Elektromagnetische Verträglichkeit (89/336/EWG)



Carl Valentin GmbH

Postfach 3744
78026 Villingen-Schwenningen
Neckarstraße 78 – 86 u. 94
78056 Villingen-Schwenningen

Phone +49 (0)7720 9712-0
Fax +49 (0)7720 9712-9901

E-Mail info@carl-valentin.de
Internet www.carl-valentin.de

Inhalt

Bestimmungsgemäße Verwendung	8
Sicherheitshinweise	8
Umweltgerechte Entsorgung	9
Betriebsbedingungen	10
Auspacken des Direktdruckwerks	13
Lieferumfang	13
Anschließen des Direktdruckwerks	13
Vorbereitungen zur Inbetriebnahme	13
Druckansteuerung	13
Inbetriebnahme des Direktdruckwerks	13
Transferbandkassette einlegen	14
Print Settings (Druck Initialisierung)	15
Machine Parameters (Maschinen Parameter)	15
Layout Parameters (Layout)	16
Ribbon Save (Optimierung) für kontinuierlichen Modus	17
Ribbon Save (Optimierung) für intermittierenden Modus	19
Device Settings (Geräteparameter)	20
I/O Parameters (I/O Parameter)	21
Network (Netzwerk)	21
Remote Console (Remote Konsole)	21
Interface (Schnittstellen)	22
Emulation (Emulation)	22
Date & Time (Datum & Uhrzeit)	23
Service Functions (Service Funktionen)	24
Main Menu (Grundmenü)	26
Compact Flash Card	27
Technische Daten	29
Druckkopf reinigen	31
Druckkopf austauschen	31
Winkelleinstellung (intermittierender Modus)	32

Bestimmungsgemäße Verwendung

- Das Direktdruckwerk ist nach dem Stand der Technik und den anerkannten sicherheitstechnischen Regeln gebaut. Es kann dennoch bei der Verwendung Gefahr für Leib und Leben des Benutzers oder Dritter bzw. Beeinträchtigungen des Direktdruckwerks und anderer Sachwerte entstehen.
- Das Direktdruckwerk darf nur in technisch einwandfreiem Zustand sowie bestimmungsgemäß, sicherheits- und gefahrenbewusst unter Beachtung der Bedienungsanleitung benutzt werden. Insbesondere Störungen, die die Sicherheit beeinträchtigen, müssen umgehend beseitigt werden.
- Das Direktdruckwerk ist ausschließlich zum Bedrucken von geeigneten und vom Hersteller zugelassenen Materialien bestimmt. Eine andersartige oder darüber hinausgehende Benutzung ist nicht bestimmungsgemäß. Für aus missbräuchlicher Verwendung resultierende Schäden haftet der Hersteller nicht - das Risiko trägt alleine der Anwender.
- Zur bestimmungsgemäßen Verwendung gehört auch das Beachten der Betriebsanleitung, einschließlich der vom Hersteller gegebenen Wartungsempfehlungen/-vorschriften.

Sicherheitshinweise

- Das Direktdruckwerk ist für Stromnetze mit Wechselspannung von 110-230 V ausgelegt. Direktdruckwerk nur an Steckdosen mit Schutzleiterkontakt anschließen.



HINWEIS!

Bei Änderungen der Netzspannung ist der Sicherungswert entsprechend anzupassen (siehe 'Technische Daten').

- Das Direktdruckwerk ist nur mit Geräten zu verbinden, die Schutzkleinspannung führen.
- Vor dem Herstellen oder Lösen von Anschlüssen alle betroffenen Geräte (Computer, Drucker, Zubehör) ausschalten.
- Das Direktdruckwerk darf nur in einer trockenen Umgebung betrieben und keiner Nässe (Spritzwasser, Nebel, etc.) ausgesetzt werden.
- Das Direktdruckwerk nicht in explosionsgefährdeter Atmosphäre und nicht in Nähe von Hochspannungsleitungen betreiben.
- Das Gerät nur in Umgebungen einsetzen die vor Schleifstäuben, Metallspänen und ähnlichen Fremdkörpern geschützt sind.
- Bei Wartungs- und Instandhaltungsmaßnahmen bei geöffnetem Deckel, ist darauf zu achten, dass Kleidung, Haare, Schmuckstücke oder ähnliches von Personen nicht mit den offen liegenden, rotierenden Teilen in Berührung kommen.



HINWEIS!

Bei der offenen Druckeinheit sind baubedingt die Anforderungen der EN60950-1 hinsichtlich Brandschutzgehäuse nicht erfüllt. Diese müssen durch den Einbau in das Endgerät gewährleistet werden.

- Die Druckbaugruppe kann während des Drucks heiß werden. Während des Betriebs nicht berühren und vor Materialwechsel, Ausbauen oder Justieren abkühlen lassen.
- Nur die in der Bedienungsanleitung beschriebenen Handlungen dürfen ausgeführt werden. Arbeiten die darüber hinausgehen dürfen nur vom Hersteller oder in Abstimmung mit dem Hersteller durchgeführt werden.
- Unsachgemäße Eingriffe an elektronischen Baugruppen und deren Software können Störungen verursachen.
- Unsachgemäße Arbeiten oder andere Veränderungen am Gerät können die Betriebssicherheit gefährden.
- Servicearbeiten immer in einer qualifizierten Werkstatt durchführen lassen, die die notwendigen Fachkenntnisse und Werkzeug zur Durchführung der erforderlichen Arbeit besitzt.
- An den Geräten sind Warnhinweis-Etiketten angebracht. Keine Warnhinweis-Etiketten entfernen sonst können Gefahren nicht erkannt werden.
- Das Direktdruckwerk ist beim Einbau in die Gesamt-Maschine in den NOT-AUS-Kreis einzubinden.
- Vor Ingangsetzung der Maschine müssen alle trennenden Schutzeinrichtungen angebracht sein.



GEFAHR!

Lebensgefahr durch Netzspannung!

⇒ Gehäuse des Geräts nicht öffnen.

**HINWEIS!**

Für Norwegen und Schweden

Geräte, die über einen Netzanschluss mit einer Verbindung zur Schutzerdung an die Schutzerdung der elektrischen Anlage des Gebäudes und an ein Kabelverteilsystem mit Koaxialkabeln angeschlossen sind, können unter bestimmten Umständen Brandgefahren verursachen. Die Verbindung mit einem Kabelverteilsystem muss daher über eine Einrichtung erfolgen, die eine elektrische Isolierung unterhalb eines bestimmten Frequenzbereichs bereitstellt.

Umweltgerechte Entsorgung

Hersteller von B2B-Geräten sind ab dem 23.03.2006 verpflichtet Altgeräte, die nach dem 13.08.2005 hergestellt wurden, zurückzunehmen und zu verwerten. Diese Altgeräte dürfen grundsätzlich nicht an kommunalen Sammelstellen abgegeben werden. Sie dürfen nur vom Hersteller organisiert verwertet und entsorgt werden. Entsprechend gekennzeichnete Valentin Produkte können daher zukünftig an Carl Valentin GmbH zurückgegeben werden.

Die Altgeräte werden daraufhin fachgerecht entsorgt.

Die Carl Valentin GmbH nimmt dadurch alle Verpflichtungen im Rahmen der Altgeräteentsorgung rechtzeitig wahr und ermöglicht damit auch weiterhin den reibungslosen Vertrieb der Produkte. Wir können nur frachtfrei zugesandte Geräte zurücknehmen.

Weitere Informationen finden Sie in der WEEE Richtlinie oder auf unserer Internetseite www.carl-valentin.de.

Betriebsbedingungen

Die Betriebsbedingungen sind Voraussetzungen, die vor Inbetriebnahme und während des Betriebs unserer Geräte erfüllt sein müssen, um einen sicheren und störungsfreien Betrieb zu gewährleisten.

Bitte lesen Sie die Betriebsbedingungen aufmerksam durch.

Falls Sie Fragen, im Hinblick auf die praktischen Anwendungen der Betriebsbedingungen haben, setzen Sie sich mit uns oder Ihrer zuständigen Kundendienststelle in Verbindung.

Allgemeine Bedingungen

Die Geräte sind bis zur Aufstellung nur in der Originalverpackung zu transportieren und aufzubewahren.

Die Geräte dürfen nicht aufgestellt und nicht in Betrieb genommen werden, bevor die Betriebsbedingungen erfüllt sind.

Die Inbetriebnahme ist solange untersagt, bis festgestellt wurde, dass - soweit zutreffend - die Maschine, in die die unvollständige Maschine eingebaut werden soll, den Bestimmungen der Maschinenrichtlinie 2006/42/EG entspricht.

Inbetriebnahme, Programmierung, Bedienung, Reinigung und Pflege unserer Geräte dürfen nur nach gründlichem Lesen unserer Anleitungen durchgeführt werden.

Die Geräte dürfen nur von geschultem Personal bedient werden.



HINWEIS!

Wiederholt Schulungen durchführen.

Inhalt der Schulung sind die Kapitel 'Betriebsbedingungen', 'Material einlegen' und 'Wartung und Reinigung'.

Die Hinweise gelten ebenfalls für die von uns gelieferten Fremdgeräte.

Es dürfen nur Original Ersatz- und Austauschteile verwendet werden.

Bezüglich Ersatz-/Verschleißteilen bitte an den Hersteller wenden.

Hinweise zur Lithium Batterie

Für die Lithium Batterie (Typ CR 2032), die sich auf der CPU des Direktdruckwerks befindet, gilt die Batterieverordnung die vorsieht, dass entladene Batterien in Altbatteriesammelgefäße des Handels und der öffentlich-rechtlichen Entsorgungsträger zu geben sind. Falls Batterien nicht vollständig entladen sind, müssen Maßnahmen gegen Kurzschlüsse getroffen werden. Bei einer Außerbetriebsetzung des Direktdruckwerks muss die Batterie in jedem Fall getrennt vom Gerät entsorgt werden.



GEFAHR!

Lebensgefahr durch Explosion!

⇒ Nicht leitendes Werkzeug benutzen.

Bedingungen an den Aufstellungsort

Die Aufstellfläche sollte eben, erschütterungs-, schwingungs- und luftzugsfrei sein.

Die Geräte sind so anzuordnen, dass eine optimale Bedienung und eine gute Zugänglichkeit zur Wartung möglich sein.

Installation der bauseitigen Netzversorgung

Die Installation der Netzversorgung zum Anschluss unserer Geräte muss nach den internationalen Vorschriften und den daraus abgeleiteten Bestimmungen erfolgen. Hierzu gehören im Wesentlichen die Empfehlungen einer der drei folgenden Kommissionen:

- Internationale Elektronische Kommission (IEC)
- Europäisches Komitee für Elektronische Normung (CENELEC)
- Verband Deutscher Elektrotechniker (VDE)

Unsere Geräte sind nach VDE-Schutzklasse I gebaut und müssen an einen Schutzleiter angeschlossen werden. Die bauseitige Netzversorgung muss einen Schutzleiter haben, um geräteinterne Störspannungen abzuleiten.

Technische Daten der Netzversorgung

Netzspannung und Netzfrequenz:	Siehe Typenschild
Zulässige Toleranz der Netzspannung:	+6% bis -10% vom Nennwert
Zulässige Toleranz der Netzfrequenz:	+2% bis -2% vom Nennwert
Zulässiger Klirrfaktor der Netzspannung:	<=5%

Entstörmaßnahmen:

Bei stark verseuchtem Netz (z.B. bei Einsatz von thyristorgesteuerten Anlagen) müssen bauseits Entstörmaßnahmen getroffen werden. Sie haben zum Beispiel folgende Möglichkeiten:

- Separate Netzzuleitung zu unseren Geräten vorsehen.
- In Problemfällen kapazitiv entkoppelten Trenntransformator oder sonstiges Entstörgerät in die Netzzuleitung vor unseren Geräten einbauen.

Störstrahlung und Störfestigkeit

Störaussendung/Emission gemäß EN 61000-6-4: 08-2002

- Störspannung auf Leitungen gemäß EN 55022: 09-2003
- Störfeldstärke gemäß EN 55022: 09-2003
- Oberschwingungsströme (Netzurückwirkung) gemäß EN 61000-3-2: 09-2005
- Flicker gemäß EN 61000-3-3: 05-2002

Störfestigkeit/Immunity gemäß EN 61000-6-2: 03-2006

- Störfestigkeit gegen Entladung statischer Elektrizität gemäß EN 61000-4-2: 12-2001
- Elektromagnetischer Felder gemäß EN 61000-4-3: 11-2003
- Störfestigkeit gegen schnelle elektrische Transienten (Burst) gemäß EN 61000-4-4: 07-2005
- Störfestigkeit gegen Stoßspannungen (Surge) gemäß EN 61000-4-5: 12-2001
- Hochfrequente Spannungen gemäß EN 61000-4-6: 12-2001
- Spannungsunterbrechungen und Spannungsabsenkung gemäß EN 61000-4-11: 02-2005



HINWEIS!

Dies ist eine Einrichtung der Klasse A. Diese Einrichtung kann im Wohnbereich Funkstörungen verursachen; in diesem Fall kann vom Betreiber verlangt werden, angemessene Maßnahmen durchzuführen und dafür aufzukommen.

Sicherheit

- EN 415-2 - Sicherheit von Verpackungsmaschinen
- EN 60204-1:2006 - Sicherheit von Maschinen - Elektrische Ausrüstung von Maschinen - Teil 1

Verbindungsleitungen zu externen Geräten

Alle Verbindungen müssen in abgeschirmten Leitungen geführt werden. Das Schirmgeflecht muss auf beiden Seiten großflächig mit dem Steckergehäuse verbunden werden.

Es darf keine parallele Leitungsführung zu Stromleitungen erfolgen. Bei unvermeidlicher Parallelführung ist ein Mindestabstand von 0,5 m einzuhalten.

Temperaturbereich der Leitungen: -15 bis +80 °C.

Es dürfen nur Geräte mit Stromkreisen angeschlossen werden die die Anforderung 'Safety Extra Low Voltage' (SELV) erfüllen. Im Allgemeinen sind dies Geräte, die nach EN 60950 geprüft sind.

Installation Datenleitungen

Die Datenkabel müssen vollständig geschirmt und mit Metall- oder metallisierten Steckverbindergehäusen versehen sein. Geschirmte Kabel und Steckverbinder sind erforderlich, um Ausstrahlung und Empfang elektrischer Störung zu vermeiden.

Zulässige Leitungen

Abgeschirmte Leitung: 4 x 2 x 0,14 mm² (4 x 2 x AWG 26)
 6 x 2 x 0,14 mm² (6 x 2 x AWG 26)
 12 x 2 x 0,14 mm² (12 x 2 x AWG 26)

Sende- und Empfangsleitungen müssen jeweils paarig verdreht sein.

Maximale Leitungslängen: bei Schnittstelle V 24 (RS232C) - 15 m bei max. 19200 bds
 bei Centronics - 3 m
 bei USB - 3 m
 bei Ethernet - 100 m

Luftkonvektion

Um eine unzulässige Erwärmung zu vermeiden, muss sich um das Gerät eine freie Luftkonvektion bilden können.

Grenzwerte

Schutzart gemäß IP:	20
Umgebungstemperatur °C (Betrieb):	Min. +5 Max. +40
Umgebungstemperatur °C (Transport, Lagerung):	Min. -25 Max. +60
Relative Luftfeuchte % (Betrieb):	Max. 80
Relative Luftfeuchte % (Transport, Lagerung):	Max. 80 (Betaung der Geräte nicht zulässig)

Gewährleistung

Wir lehnen die Haftung für Schäden ab, die entstehen können durch:

- Nichtbeachtung unserer Betriebsbedingungen und Bedienungsanleitung.
- Fehlerhafte elektrische Installation der Umgebung.
- Bauliche Veränderungen an unseren Geräten.
- Fehlerhafte Programmierung und Bedienung.
- Nicht durchgeführte Datensicherung.
- Verwendung von nicht Original Ersatz- und Zubehörteilen.
- Natürlichem Verschleiß und Abnutzung.

Wenn Sie Geräte neu einstellen oder programmieren, kontrollieren Sie die Neueinstellung durch einen Probelauf und Probendruck. Sie vermeiden dadurch fehlerhafte Ergebnisse, Auszeichnungen und Auswertungen.

Die Geräte dürfen nur von geschulten Mitarbeitern bedient werden.

Kontrollieren Sie den sachgemäßen Umgang mit unseren Produkten und wiederholen Sie Schulungen.

Wir übernehmen keine Garantie dafür, dass alle in dieser Anleitung beschriebenen Eigenschaften bei allen Modellen vorhanden sind. Bedingt durch unser Streben nach ständiger Weiterentwicklung und Verbesserung besteht die Möglichkeit, dass sich technische Daten ändern, ohne dass eine Mitteilung darüber erfolgt.

Durch Weiterentwicklung oder länderspezifischen Vorschriften können Bilder und Beispiele in der Anleitungen von der gelieferten Ausführung abweichen.

Bitte beachten Sie die Informationen über zulässige Druckmedien und die Hinweise zur Gerätepflege, um Beschädigungen oder vorzeitigen Verschleiß zu vermeiden.

Wir haben uns bemüht, dieses Handbuch in verständlicher Form zu verfassen, und Ihnen möglichst viele Informationen zu geben. Falls sich Fragen ergeben oder wenn Sie Fehler entdecken, bitte teilen Sie uns dies mit, damit wir die Möglichkeit haben, unsere Handbücher zu verbessern.

Auspacken des Direktdruckwerks

- ⇒ Direktdruckwerk aus dem Karton heben.
- ⇒ Direktdruckwerk auf Transportschäden prüfen.
- ⇒ Lieferung auf Vollständigkeit prüfen.

Lieferumfang

- Druckmechanik.
- Ansteuerelektronik.
- Netzkabel.
- Verbindungskabel (Sensoren, Power).
- Miniregler.
- Manometer.
- Pneumatikschlauch.
- Steckverschraubung.
- I/O Zubehör (Gegenstecker für I/Os, I/O 24 Kabel).
- 1 Rolle Transferband.
- Pappkern (leer), auf Transferbandaufwicklung vormontiert.
- Reinigungsfolie für Druckkopf.
- Dokumentation.
- Druckertreiber CD.



HINWEIS!

Originalverpackung für eventuelle spätere Lieferungen aufbewahren.

Anschließen des Direktdruckwerks

Das Direktdruckwerk ist mit einem Weitbereichsnetzteil ausgerüstet. Der Betrieb mit einer Netzspannung von 110-230 V / 50-60 Hz ist ohne Eingriff am Gerät möglich.



VORSICHT!

Beschädigung des Gerätes durch undefinierte Einschaltströme.

- ⇒ Vor dem Netzanschluss den Netzschalter auf Stellung 'O' bringen.
- ⇒ Netzkabel in Netzanschlussbuchse stecken.
- ⇒ Stecker des Netzkabels in geerdete Steckdose stecken.



HINWEIS!

Durch unzureichende oder fehlende Erdung können Störungen im Betrieb auftreten.

Darauf achten, dass alle an das Direktdruckwerk angeschlossenen Computer sowie die Verbindungskabel geerdet sind.

- ⇒ Direktdruckwerk mit Computer oder Netzwerk mit einem geeigneten Kabel verbinden.

Vorbereitungen zur Inbetriebnahme

- ⇒ Druckmechanik montieren.
- ⇒ Verbindungskabel zwischen Druckmechanik und Ansteuerelektronik einstecken und gegen unabsichtliches Lösen sichern.
- ⇒ Druckluftleitung anschließen.
- ⇒ Verbindung zwischen Ansteuerelektronik und PC über Druckerschnittstellen herstellen.
- ⇒ Verbindung zwischen Ansteuerelektronik und Verpackungsmaschine über Steuereingänge und Steuerausgänge herstellen.
- ⇒ Netzkabel der Ansteuerelektronik anschließen.

Druckansteuerung

Da sich das Direktdruckwerk immer im Steuermodus befindet, können über die vorhandenen Schnittstellen (seriell, parallel, USB oder evtl. Ethernet) die Druckaufträge nur übertragen, jedoch nicht gestartet werden. Der Druck wird durch ein Startsignal auf den Druckstart-Steuereingang gestartet. Damit die Ansteuerelektronik erkennt, wann das Startsignal gesetzt werden kann, ist es möglich und größtenteils auch notwendig über die Steuerausgänge den Druckstatus zu verfolgen.

Inbetriebnahme des Direktdruckwerks

Wenn alle Anschlüsse hergestellt sind:

- ⇒ Ansteuerelektronik am Netzschalter einschalten. Nach Einschalten der Ansteuerelektronik erscheint das Grundmenü. Angezeigt werden der Gerätetyp, das aktuelle Datum und die Uhrzeit.
- ⇒ Transferbandkassette einlegen. Nach Einlegen der Transferbankassette wird eine Messung des Transferbandes ausgeführt und der Druckkopf in die Druckposition bewegt.

Transferband Kassette einlegen



HINWEIS!

Da durch elektrostatische Entladung die dünne Beschichtung des Thermodruckkopfes oder andere elektronische Teile beschädigt werden können, sollte das Transferband antistatisch sein.

Die Verwendung falscher Materialien kann zu Fehlfunktionen des Druckers führen und die Garantie erlöschen lassen.

Außengewickeltes Transferband



HINWEIS!

Bevor eine neue Transferbandrolle eingelegt wird, ist der Druckkopf mit Druckkopf- und Walzenreiniger (97.20.002) zu reinigen.

Die Handhabungsvorschriften zur Verwendung von Isopropanol (IPA) sind zu beachten. Bei Kontakt mit der Haut oder den Augen mit fließendem Wasser gründlich auswaschen. Bei anhaltender Reizung Arzt aufsuchen. Für gute Belüftung sorgen.

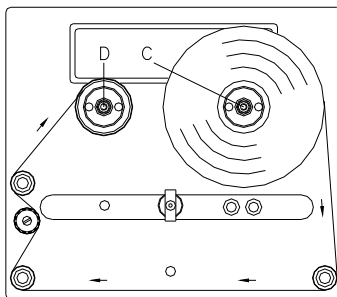
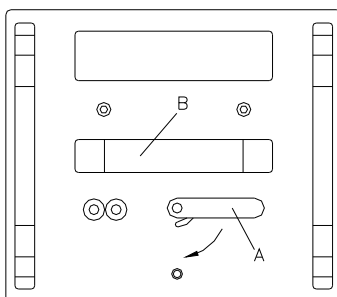

Die Abbildung zeigt ein linkes Drucksystem. Beim rechten Drucksystem ist die neue Rolle links und der Pappkern rechts aufzustecken.

- Hebel (A) um 90° im Uhrzeigersinn drehen.
- Transferband Kassette durch Ziehen am Griff (B) von der Druckmechanik abnehmen.
- Neue Transferbandrolle bis zum Anschlag auf die Abwickelvorrichtung (C) aufstecken.
- Leere Papphülse bis zum Anschlag auf die Aufwickelvorrichtung (D) aufstecken.
- Transferband gemäß der Abbildung einlegen.
- Transferband mit einem Klebestreifen an der Leerhülse festkleben und durch einige Umdrehungen der Hülse straffen.
- Transferband Kassette wieder auf die Druckmechanik schieben darauf achten, dass das Transferband dabei nicht einreißt.
- Hebel (A) um 90° gegen den Uhrzeigersinn drehen.

Innengewickeltes Transferband

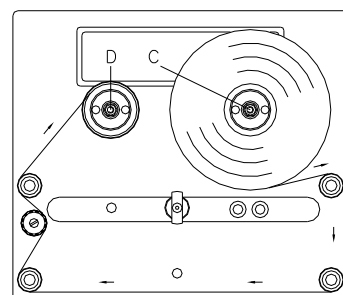
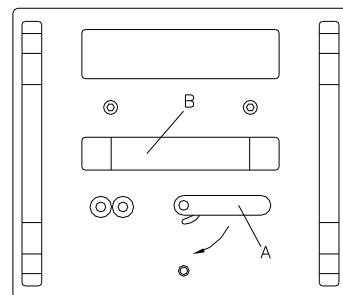

Die Abbildung zeigt ein linkes Drucksystem. Beim rechten Drucksystem ist die neue Rolle links und der Pappkern rechts aufzustecken.

- Hebel (A) um 90° im Uhrzeigersinn drehen.
- Transferband Kassette durch Ziehen am Griff (B) von der Druckmechanik abnehmen.
- Neue Transferbandrolle (A) bis zum Anschlag auf die Abwickelvorrichtung (C) aufstecken.
- Leere Papphülse bis zum Anschlag auf die Aufwickelvorrichtung (D) aufstecken.
- Transferband gemäß der Abbildung einlegen.
- Transferband mit einem Klebestreifen an der Leerhülse festkleben und durch einige Umdrehungen der Hülse straffen.
- Transferband Kassette wieder auf die Druckmechanik schieben darauf achten, dass das Transferband dabei nicht einreißt.
- Hebel (A) um 90° gegen den Uhrzeigersinn drehen.

Print Settings (Druck Initialisierung)

Tastenfolge: **F**

Funktionsmenü
Druck Init

Taste:

Kontinuierlicher Modus

Brennstärke
(in %): 100

Contrast (Brennstärke):
Wertebereich: 10% ... 200%.

Intermittierender Modus

Geschw: 100
Brennst: 100

Speed (Geschwindigkeit):
Wertebereich: 50 mm/s ... 200 mm/s.
Contrast (Brennstärke):
Wertebereich: 10% ... 200%.

Taste:

Prüfung TR-Band
EIN starke Empf

Transfer ribbon control (Transferbandüberwachung):
Off (Aus): Die Transferbandüberwachung ist deaktiviert.
On (Ein): Die Transferbandüberwachung ist aktiviert.
strong sensibility (starke Empfindlichkeit): Das Direktdruckwerk reagiert sofort auf das Ende des Transferbandes.
weak sensibility (schwache Empfindlichkeit): Das Direktdruckwerk reagiert um ca. 1/3 langsamer auf das Ende des Transferbandes.

Taste:

X-Verschiebung
Offs (mm): -1.5

X displacement (X-Verschiebung):
Angabe der Verschiebung in X-Richtung.
Wertebereich: -90.0 ... +90.0

Machine Parameters (Maschinen Parameter)

Kontinuierlicher Modus

Tastenfolge: **F**,

Funktionsmenü
Maschinen Para.

Taste:

Betriebsart
IO DY

Operating mode (Betriebsart):
Auswahl der Betriebsart.

Taste:

Druck-Offset
(mm) 10.0

Print offset (Druck-Offset):
Abstand Layouts zum Maschinennullpunkt.
Wertebereich: 1 ... 999 mm

Taste:

Druck Position
(mm) 20.0

Print position (Druck Position):
Startposition des Druckschlittens in mm.
Wertebereich: 12 ... 93 mm

Taste:

Layouts/Zyklus
1

Layouts/cycle (Layouts/Zyklus):
Angabe der Druckvorgänge pro Drucklänge.
Wertebereich: 1 ... 25 Layouts pro Zyklus.

Intermittierender Modus

Tastenfolge: **F**,

Funktionsmenü
Maschinen Para.

Taste:

Mode
2 Fortlaufend

Operating mode (Betriebsart):
Auswahl der Betriebsart.

Taste:

Back-Speed mm/s
400

Back speed (Rückfahr-Geschwindigkeit):
Angabe der Rückfahrgeschwindigkeit der Druckmechanik nach Druckende in mm/s.
Wertebereich: 50 ... 600 mm/s.

Taste:

Druck-Offset
(mm) 10.0

Print offset (Druck-Offset):
Abstand des Layouts zum Maschinennullpunkt.
Wertebereich: 1 ... 999 mm

Taste:

Druck Position
(mm) 20.0

Print position (Druck Position):
Startposition des Druckschlittens in mm.
Wertebereich: 12 ... 93 mm

Kontinuierlicher Modus

Taste: 

ChkSpeed On Strt
Off

Check speed on start (Materialgeschwindigkeit bei Druckstartsignal prüfen):
Überprüfung der Materialgeschwindigkeit bei Druckstartsignal.

Taste: 

Res. mm/360°
2000 166

Encoder resolution / material feed per encoder rotation (Encoderauflösung / Materialvorschub pro Drehgeberumgebung):

Zeigt die Auflösung des verwendeten Drehgebers und den Materialvorschub pro Drehgeberumdrehung in mm an.

Taste: 

Material Geschw:
200 mm/s

Material speed (Materialgeschwindigkeit):

Anzeige der eingestellten Geschwindigkeit des Materials.

Intermittierender Modus

Taste: 

Layouts/Zyklus
1

Layouts/cycle (Layouts/Zyklus):

Angabe der Druckvorgänge pro Drucklänge.
Wertebereich: 1 ... 25 Layouts pro Zyklus.

Layout Parameters (Layout)

Tastenfolge: **F**, , 

Funktionsmenü
Layout

Taste: 

Drucklänge (mm)
140.0

Print length (Drucklänge):

Angabe des Wegs den die Druckmechanik zurücklegen soll. Drucklänge. Die Drucklänge richtet sich nach der Länge der Druckmechanik.

Taste: 

Breite: 20.0
Anzahl Bahnen: 4

Column printing (Mehrbahniger Druck):

Angabe der Breite eines Layouts sowie die Angabe wie viele Layouts nebeneinander auf dem Trägermaterial sind.

Taste: 

Material
Typ 2

Material selection (Materialauswahl):

Auswahl des verwendeten Materials.

Taste: 

Layout spiegeln
Ein

Flip layout (Layout spiegeln):

Die Spiegelachse befindet sich auf der Mitte des Layouts. Wenn die Layoutbreite nicht an das Druckmodul übertragen wurde, wird die Default Layoutbreite, d.h. die Breite des Druckkopfs verwendet. Aus diesem Grund sollten Sie darauf achten, dass das Layout so breit wie der Druckkopf ist. Andernfalls könnte es zu Problemen bei der Positionierung führen.

Taste: 

Layout drehen
Aus

Rotate layout (Layout drehen):

Standardmäßig wird das Layout Kopf voraus mit 0° Drehung gedruckt. Wird die Funktion aktiviert, wird das Layout um 180° gedreht und in Leserichtung gedruckt.

Taste: 

Ausrichtung
Links

Alignment (Ausrichtung):

Die Ausrichtung des Layouts erfolgt erst nach dem Drehen/Spiegeln, d.h. die Ausrichtung ist unabhängig von Drehung und Spiegelung.

Left (Links): Das Layout wird am linken Rand des Druckkopfes ausgerichtet.

Centre (Mitte): Das Layout wird am Mittelpunkt des Druckkopfes (zentriert) ausgerichtet.

Right (Rechts): Das Layout wird am rechten Rand des Druckkopfes ausgerichtet.

Ribbon Save (Optimierung) - Kontinuierlicher Modus

Tastenfolge: **F**, , , 

Funktionsmenü
Optimierung

Taste: 

Mode Speed
Standard 600

Mode (Betriebsart): Auswahl der Optimierungsart.

Off (Aus): Optimierung aus.

Standard (Standard): Maximale Optimierungsleistung.

SaveStrt (Startsignal speichern): Keine Startsignalverluste.

Speed (Geschwindigkeit): Festlegen der max. Druckgeschwindigkeit.

Mode: Standard

R-Correction
-1 mm

Transfer ribbon correction (Transferband Korrektur):

0 mm = Es wird immer soweit zurückgezogen, dass eine optimale Optimierung erreicht wird (kein Transferbandverlust).

Defaultwert: -1 mm

-xx mm = Der Rückzug kann verkleinert werden.

+xx mm = Der Rückzug kann vergrößert werden.

Taste: 

sa/mm cmin so/mm
303 1000 10

Performance information (Leistungsinformation):

sa/mm: Der kleinst mögliche Abstand zweier Drucke bei voller Optimierung.

cmin: Max. Anzahl an Takten pro Minute.

so/mm: Angabe des Optimierungsverlusts.

Taste: 

ExpertParameters

ExpertParameters (Expert parameters):

Passwort eingeben, Taste  drücken und die nachfolgenden Parameter werden angezeigt.

Taste: 

PhDownT REStartT
30 ms 10 ms

PhDownT = Printhead down time (DK Abwärts) in ms:

Start der Druckkopf-Abwärtsbewegung wird errechnet.

REStartT = Ribbon motor early start time (TRB Motor Startzeit) in ms:

Wert wird hinzugezählt zur Zunahmezeit der Transferbandbewegung.

Taste: 

MinSpeed Calcoff
50 mm/s On

MinSpeed = Minimal print speed (Min. Druckgeschwindigkeit):

Wird die min. Druckgeschwindigkeit erhöht, erhöht sich auch die max. Anzahl der Zyklen.

Calcoff = Print offset border calculation (Druckoffset Berechnung):

Wird der Parameter auf Off gesetzt, kann ein kleinerer als der benötigte Druckoffset eingegeben werden.

Taste: 

PhUpT PhVReactT
20 ms 10 ms

PhUpT = Printhead up time (DK Aufwärts) in ms:

Berechnung ob eine Feldoptimierung durchgeführt werden kann oder nicht.

PhVReactT = Printhead valve reaction time (DK Aufwärt Start) in ms:

Berechnung des Starts der Druckkopf-Aufwärtsbewegung.

Taste: 

RibMotStpDlayT
2 ms

RibMotStpDlayT = Ribbon motor stop delay time (Verzögerungszeit):

Verzögerungszeit in ms die der Transferbandmotor vor dem Stoppen noch mit gleichbleibender Geschwindigkeit weiterbewegt wird.

Taste: 

FieldRS Rwind v
Normal 600mm/s

FieldRS = Field ribbon saving (Feldoptimierung):

Off (Aus): Feldoptimierung Aus

PHOnly (Nur DK): Nur der Druckkopf wird bewegt. Das Transferband wird nicht angehalten.

Normal (Normal): Feldoptimierung wird nur ausgeführt, wenn der Transferbandmotor komplett gestoppt wird.

Strong (stark): Feldoptimierung wird ausgeführt, selbst wenn der Transferbandmotor nicht gestoppt wird.

Rwind v = Rewind speed (Rückspulung) in mm/s:

Angabe der Rückspulung in mm/s.

Taste: 

Speed 1. Field
400 mm/s

Speed 1 field (Feld 1 Geschwindigkeit):

Wenn 0 (Defaultwert) eingestellt ist, hat der Parameter keinen Einfluss auf die Optimierung.

Taste: 

Tension
0 mm

Tension (Spannung):

Angabe der Länge, die nach dem Messen des Transferbandes nach vorne transportiert wird.

Mode: Shift

X-Shift Y-Shift
10 mm 13 mm

X-Shift / Y-Shift (X-Offset / Y-Offset):

X-Shift (X-Offset): Angabe der Verschiebung des Druckbilds in X-Richtung.

Y-Shift (Y-Offset): Angabe der Verschiebung in Druckrichtung.

Taste: 

Lanes R-Shift
3 -5 mm

Lanes / R-Shift (Bahnen / R-Offset):

Lanes (Bahnen): Angabe der Anzahl der nebeneinander gedruckten Zyklen.

R-Shift (R-Offset): Angabe des Abstands beim Wechsel auf einen neuen Zyklus.

Taste: 

ExpertParameters

Expert parameters (Experten Parameter):

Passwort eingeben und Taste  drücken, um die Parameter anzuzeigen.

Die Beschreibung ist unter Mode 'Standard' zu finden.

Mode: SaveStrt

ExpertParameters

Expert parameters (Experten Parameter):

Passwort eingeben und Taste  drücken, um die Parameter anzuzeigen.

Die Beschreibung ist unter Mode 'Standard' zu finden.

Ribbon Save (Optimierung) - Intermittierender Modus

Tastenfolge: **F**, , , 

Funktionsmenü
Optimierung

Taste: 

Mode
Standard

Mode (Betriebsart): Auswahl der Optimierungsart.
Off (Aus): Optimierung aus.
Standard (Standard): Maximale Optimierungsleistung.
Shift (Versatz): Maximale Ausnutzung des Transferbandes.

Mode: Standard

R-Correction
-1 mm

Transfer ribbon correction (Transferband Korrektur):
0 mm = Es wird immer soweit zurückgezogen, dass eine optimale Optimierung erreicht wird (kein Transferbandverlust).
 Defaultwert: -1 mm
-xx mm = Der Rückzug kann verkleinert werden.
+xx mm = Der Rückzug kann vergrößert werden.

Taste: 

ExpertParameters

Expert parameters (Experten Parameter):
 Passwort eingeben, Taste  drücken und die nachfolgenden Parameter werden angezeigt.

Taste: 

PhDownT PhUpT
35 ms 0 ms

PhDownT = Printhead down time (DK Abwärts) in ms:
 Start der Druckkopf-Abwärtsbewegung wird errechnet.
PhUpT = Printhead up time (DK Aufwärts) in ms:
 Berechnung ob eine Feldoptimierung durchgeführt werden kann oder nicht.

Taste: 

PhVReactT
10 ms

PhVReactT = Printhead valve reaction time (DK Aufwärt Start) in ms:
 Berechnung des Starts der Druckkopf-Aufwärtsbewegung.

Taste: 

Tension RM
0 mm 0

Tension / Ribbon Mode (Spannung / Rückzugs Mode):
Tension (Spannung): Angabe der Länge, die nach dem Messen des Transferbandes nach vorne transportiert wird.

Ribbon Mode (Rückzugs Mode):
0: Das Transferband wird nach jedem Druck über die gesamte Drucklänge zurückgezogen, d.h. es findet keine Optimierung zwischen den einzelnen Layouts statt.
1: Das Transferband wird nur über den bedruckten Bereich zurückgezogen, d.h. die Lücken zwischen den Layouts werden optimiert.
 Bei Wechsel des Layouts wird das Transferband automatisch positioniert.

Mode: Shift

X-Shift Y-Shift
10 mm 13 mm

X-Shift / Y-Shift (X-Offset / Y-Offset):
X-Shift (X-Offset): Angabe der Verschiebung des Druckbilds in X-Richtung.
Y-Shift (Y-Offset): Angabe der Verschiebung in Druckrichtung.

Taste: 

Lanes R-Shift
3 -5 mm

Lanes / R-Shift (Bahnen / R-Offset):
Lanes (Bahnen): Angabe der Anzahl der nebeneinander gedruckten Zyklen.
R-Shift (Rpckzugs Mode): Angabe des Abstands beim Wechsel auf einen neuen Zyklus.

Taste: 

ExpertParameters

Expert parameters (Experten Parameter):
 Passwort eingeben und Taste  drücken, um die Parameter anzuzeigen.
 Die Beschreibung ist unter Mode 'Standard' zu finden.

Device Settings (Geräteparameter)

Tastenfolge: **F**, , , , 

Funktionsmenü
Geräteparameter

Taste: 

Feldverwaltung
AUS

Field handling (Feldverwaltung):

Off (Aus): Der gesamte Druckspeicher wird gelöscht.

Keep graphic (Grafik erhalten): Eine Grafik bzw. ein TrueType Font wird ein Mal an das Direktdruckwerk übertragen und im druckerinternen Speicher abgelegt. Für den folgenden Druckauftrag werden jetzt nur noch die geänderten Daten an das Direktdruckwerk übertragen. Der Vorteil hierbei ist die Einsparung der Übertragungszeit der Grafikdaten.

Delete graphic (Grafik löschen): Die im druckerinternen Speicher abgelegten Grafiken bzw. TrueType Fonts werden gelöscht, die übrigen Felder jedoch erhalten.

Taste: 

Auswahl Codepage
GEM deutsch

Codepage (Codepage):

Auswahl des zu verwendeten Zeichensatzes. Folgende Möglichkeiten stehen zur Verfügung: ANSI-Zeichensatz / Codepage 437 / Codepage 850 / GEM deutsch / GEM englisch / GEM französisch / GEM schwedisch / GEM dänisch

Taste: 

ext. Parameter
EIN

External parameters (Externe Parameter):

Layout dimension only (Nur Layout-Abmessung): Die Parameter für Layoutlänge, Schlitzlänge und Layoutbreite können übertragen werden. Alle weiteren Parametereinstellungen müssen am direkt am Drucksystem vorgenommen werden.

On (Ein): Parameter wie Druckgeschwindigkeit und Brennstärke können über unsere Design Software an das Direktdruckwerk übertragen werden. Parameter die vorher direkt am Direktdruckwerk eingestellt wurden, werden nicht mehr berücksichtigt.

Off (Aus): Es werden nur Einstellungen die am Direktdruckwerk direkt gemacht werden berücksichtigt.

Taste: 

Buzzer
Ein

Buzzer (Summer):

On (Ein): Beim Drücken jeder Taste ist ein akustisches Signal hörbar. Wertebereich: 1 ... 7

Off (Aus): Es ist kein Signal hörbar.

Taste: 

Sprache
Deutsch

Language (Sprache):

Auswahl der Sprache, in der die Texte im Display angezeigt werden sollen. Folgende Möglichkeit stehen zur Verfügung: Deutsch, Englisch, Französisch, Spanisch, Portugiesisch, Niederländisch, Italienisch, Dänisch, Finnisch, Polnisch, Tschechisch und Russisch.

Taste: 

Bedienereingabe
Ein

Customized entry (Bedienereingabe):

On (Ein): Die Abfrage nach der bedienergeführten Variablen erscheint einmalig vor Druckstart im Display.

Auto: Die Abfrage nach der bedienergeführten Variablen erscheint nach jedem Layout.

Off (Aus): Im Display erscheint keine Abfrage der bedienergeführten Variable. In diesem Fall wird der hinterlegte Default-Wert gedruckt.

Taste: 

Warmstart
Aus

Hotstart (Warmstart):

On (Ein): Ein unterbrochener Druckauftrag kann nach erneutem Einschalten des Direktdruckwerks wieder fortgesetzt werden.

Off (Aus): Nach Abschalten des Direktdruckwerks gehen sämtliche Daten verloren.

Taste: 

Passwortschutz
Aktiv

Password (Passwortschutz):

Über ein Passwort können verschiedene Funktionen für die Bedienerperson gesperrt werden.

Taste: 

Layout Bestätig.
Ein

Layout confirmation (Layout Bestätigung):

On (Ein): Ein neuer Druckauftrag wird erst nach Bestätigung am Gerät gedruckt.

Ein bereits aktiver fortlaufender Druckauftrag wird weiter gedruckt, bis die Bestätigung am Gerät erfolgt.

Off (Aus): Es erscheint keine Abfrage am Display der Ansteuerung.

Taste: 

Standard-Layout
Aus

Standard layout (Standard Layout):

On (Ein): Wird ein Druckauftrag gestartet, ohne vorherige Definition eines Layouts, wird das Standard-Layout (Gerätetyp, Firmware Version, Build Version) gedruckt.

Off (Aus): Wird ein Druckauftrag gestartet, ohne vorherige Definition eines Layouts, erscheint eine Fehlermeldung im Display.

I/O Parameters (I/O Parameter)

Tastenfolge: **F**, , , , , 

Funktionsmenü
I/O Parameter

Taste: 

IN-Signalpegel
1s2x3+4x5x6x7x8x

IN signal level (IN-Signalpegel):

Angabe des Signals, bei dem ein Druckauftrag gestartet wird.

+ = aktiver Signalpegel ist 'high' (1)

- = aktiver Signalpegel ist 'low' (0)

x = nicht aktivierter Signalpegel

s = Zustand kann über Schnittstelle beeinflusst werden (in Verbindung mit Netstar PLUS)

Taste: 

OUT-Signalpegel
1+2+3+4+5+6+7+8+

OUT signal level (OUT-Signalpegel):

Angabe des Signalpegels für Ausgabesignal.

+ = aktiver Signalpegel ist 'high' (1)

- = aktiver Signalpegel ist 'low' (0)

s = Zustand kann über Schnittstelle beeinflusst werden (in Verbindung mit Netstar PLUS)

Taste: 

Entprellung (ms)
50

Debouncing (Entprellung):

Angabe der Entprellzeit des Spendeingangs.

Wertebereich: 0 ... 100 ms.

Taste: 

Start-Verzög. (s)
1.00

Start signal delay (Startsignal Verzögerung):

Angabe der Zeit in Sekunden um die der Druckstart verzögert wird.

Wertebereich: 0.00 ... 9.99.

Taste: 

ErrorIfNotReady
On

Not ready: Error (Nicht bereit: Fehler):

On: Falls ein Druckauftrag aktiv ist aber das Direktdruckwerk nicht bereit ist diesen zu verarbeiten (z.B. weil bereits im 'druckend' Mode), wird ein Fehler ausgelöst.

Off: Es wird keine Fehlermeldung ausgelöst.

Taste: 

Bereit währ Drk
Aus

Ready while printing (Bereit während Druck):

Einstellung, ob das Ausgangssignal 'Druck-Bereit' (Out 5, Output II) während des Druckens aktiv bleibt.

Aus: Beim Druckstart wird das 'Druck-Bereit' Signal inaktiv (Standardeinstellung).

Ein: Beim Druckstart bleibt das 'Druck-Bereit' Signal aktiv.

Network (Netzwerk)

Tastenfolge: **F**, , , , , , 

Funktionsmenü
Netzwerk

Weitere Informationen über diesen Menüpunkt entnehmen Sie bitte dem separaten Handbuch.

Remote Console (Remote Konsole)

Tastenfolge: **F**, , , , , , , 

Funktionsmenü
Remote Konsole

Für Informationen über diesen Menüpunkt, wenden Sie sich bitte an unseren Vertrieb.

Interface (Schnittstellen)

Tastenfolge: **F**, , , , , , , , , 

Funktionsmenü
Schnittstellen

Taste:

COM1	Baud	P	D	S
0	9600	N	8	2

M = Mode:

0 - serielle Schnittstelle Aus
1 - serielle Schnittstelle Ein
2 - serielle Schnittstelle Ein; es wird keine Fehlermeldung bei einem Übertragungsfehler ausgelöst

Baud:

Angabe der Bits die pro Sekunde übertragen werden.
Folgende Werte können ausgewählt werden: 2400, 4800, 9600, 19200, 38400 und 115200.

P = Parität:

N - No parity; E - Even; O - Odd
Sie sollten darauf achten, dass die Einstellungen mit denen des Geräts übereinstimmen.

D = Datenbits:

Einstellung der Datenbits. Sie können entweder 7 oder 8 Bits auswählen.

S = Stoppbits:

Sie haben die Möglichkeit, 1 oder 2 Stoppbits auszuwählen.
Angabe der Stoppbits zwischen den Bytes.

Taste: 

Start (SOH):	01
Ende (ETB):	17

Start / stop sign (Start-/Stoppszeichen):

SOH: Start des Datenübertragungsblock → HEX-Format 01

ETB: Ende des Datenübertragungsblock → HEX-Format 17

Taste: 

Datenspeicher
Erweitert

Data memory (Datenspeicher):

Standard (Standard): Nach Starten eines Druckauftrags werden so lange Daten empfangen bis der Druckbuffer gefüllt ist.

Extended (Erweitert): Während eines laufenden Druckauftrags werden weiterhin Daten empfangen und verarbeitet.



Off (Aus): Nach Starten eines Druckauftrags werden keine weiteren Daten empfangen.

Taste: 

Porttest Aus

Port test (Schnittstellentest):

Überprüfung ob Daten über die Schnittstelle übertragen werden.

Tasten  und  drücken um Allgemein (On) auszuwählen. Taste drücken und Daten die über einen beliebigen Port gesendet werden (COM1, LPT, USB, TCP/IP), werden gedruckt.

Emulation (Emulation)

Tastenfolge: **F**, , , , , , , , , 

Funktionsmenü
Emulation



Taste:

Protokoll
ZPL

Protocol (Protokoll):

CVPL: Carl Valentin Programming Language

ZPL: Zebra® Programming Language

Mit den Tasten  und  das Protokoll auswählen. Taste drücken, um Auswahl zu bestätigen. Der Drucker wird neu gestartet und ZPL II®-Kommandos werden intern in CVPL-Kommandos umgewandelt.

Taste: 

DK Auflösung
11.8 (Dot/mm)

Printhead resolution (Druckkopf-Auflösung):

Bei aktivierter ZPL II®-Emulation muss die Druckkopf-Auflösung des emulierten Druckers eingestellt werden.

Taste: 

LW-Zuordnung
B: ->A: R: ->R:

Drive mapping (Laufwerk-Zuordnung):

Der Zugriff auf Zebra®-Laufwerke wird auf entsprechende Valentin-Laufwerke umgeleitet.

Date & Time (Datum & Uhrzeit)





Tastenfolge: **F**, , , , , , , , , , 

Funktionsmenü
Datum/Uhrzeit

Taste: 

Datum 17.11.04
Uhrzeit 13:28:06

Set date/time (Einstellen von Datum/Uhrzeit):

Die obere Zeile des Displays zeigt das aktuelle Datum, die untere Zeile die aktuelle Uhrzeit an. Mit Hilfe der Tasten  und  können Sie in das jeweils nächste Feld gelangen, um die angezeigten Werte mit den Tasten  und  zu erhöhen bzw. zu verkleinern.

Taste: 

Sommerzeit
Ein

Summertime (Sommerzeit):

On (Ein): Das Direktdruckwerk stellt automatisch auf Sommer- bzw. Winterzeit um.
Off (Aus): Die Sommerzeit wird nicht automatisch erkannt und umgestellt.

Taste: 

SZ Beginn Format
WW/WD/MM

Start of summertime - Format (Format Beginn Sommerzeit):

Auswahl des Formats, um den Beginn der Sommerzeit einzugeben.

DD = Tag
WW = Woche
WD = Wochentag
MM = Monat
YY = Jahr,
next day = erst der nächste Tag wird berücksichtigt

Taste: 

WW WD MM
letzteSonntag 03

Start of summertime - Date (Datum Sommerzeit Beginn):

Eingabe des Datums wann die Sommerzeit beginnen soll. Diese Eingabe bezieht sich auf das zuvor ausgewählte Format. Im obigen Beispiel wird die Sommerzeit automatisch am letzten Sonntag im März (03) umgestellt.

Taste: 

SZ Beginn Zeit
02:00

Start of summertime - Time (Uhrzeit Sommerzeit Beginn):

Mit Hilfe dieser Funktion können Sie die Uhrzeit eingeben an der die Sommerzeit beginnen soll.

Taste: 

SZ Ende Format
WW/WD/MM

End of summertime - Format (Format Ende Sommerzeit):

Auswahl des Formats, um das Ende der Sommerzeit einzugeben.

Taste: 

WW WD MM
letzeSonntag 10

End of summertime - Date (Datum Sommerzeit Ende):

Eingabe des Datums wann die Sommerzeit enden soll. Eingabe bezieht sich auf das zuvor ausgewählte Format. Im obigen Beispiel wird die Sommerzeit automatisch am letzten Sonntag im Oktober (10) umgestellt.

Taste: 

SZ Ende Zeit
03:00

End of summertime - Time (Uhrzeit Sommerzeit Ende):

Eingabe der Uhrzeit wann die Sommerzeit enden soll.

Taste: 

Zeitverschiebung
01:00

Time shifting (Zeitverschiebung):

Eingabe der Zeitverschiebung bei Sommer-/Winterzeit Umstellung in Stunden und Minuten.

Service Functions (Service Funktionen)



HINWEIS!

Damit der Händler bzw. der Gerätehersteller im Servicefall schneller Support bieten kann, können notwendige Informationen wie z.B. eingestellte Parameter direkt am Gerät abgelesen werden.

Tastenfolge: **F**, , , , , , , , , , , 

Funktionsmenü
Service Funkt.

Taste: 

H P R1 R2 C ENC
0 1 1 0 0 0

Photocell parameters (Lichtschranken Parameter):

H = Haubenschalter (nur bei Geräten mit Haubenschalter)
0 = offene Haube; 1 = geschlossene Haube.

P = Pressure:

Angabe des Wertes für die Druckluftüberwachung (0 oder 1).

R1 = Transferband Aufwickelrolle: (kommt von Dynacode)

Angabe für den Zustand der Transferband Aufwickelrolle. 4 Status werden angezeigt (keine Markierung in Lichtschranke, Markierung kommt von rechts, Markierung kommt von links, Markierung vollständig in Lichtschranke).

R2 = Transferband Abwickelrolle:

Angabe für den Zustand der Transferband Abwickelrolle. 4 Status werden angezeigt (keine Markierung in Lichtschranke, Markierung kommt von rechts, Markierung kommt von links, Markierung vollständig in Lichtschranke).

C = Carriage:

Angabe der Position des Druckschlittens.

ENC = Encoder: (kommt von Dynacode)

Angabe des aktuellen Zustands des Drehgebers.

Taste: 

Laufleistung (m)
D000007 G000017

Paper counter (Laufleistung):

D: Angabe der Druckkopfleistung in Meter.

G: Angabe der Geräteleistung in Meter.

Taste: 

Dot-Widerstand
1250

Heater resistance (Dot-Widerstand):

Um ein gutes Druckbild zu erzielen, muss bei einem Druckkopfwechsel der auf dem Druckkopf angegebene Ohm-Wert eingestellt werden.

Taste: 

Druckkopftemp.
23

Printhead temperature (Druckkopftemperatur):

Anzeige der Druckkopftemperatur.

Taste: 

Ribbon Ink Side
600 m Out

Ribbon (Länge Transferband):

Auswahl der verwendeten Transferbandlänge (300 m, 450 m, 600 m, 900 m, 1000 m).

Ink side (Wicklung):

Auswahl ob Transferbänder mit Außen- oder Innenwicklung verwendet werden.

Default: Außenwicklung

Taste: 

BrkPow BrkPowP
100 % 100 %

Brake power (Bremsleistung):

BrkPow:

Einstellen der Bremsleistung für Beschleunigen und Abbremsen in %.

BrkPowP:

Einstellen der Bremsleistung während des Druckens.

Taste: 

Druck-Beispiele
Status Report

Print examples (Druck-Beispiele):

Durch Auslösen dieses Menüpunktes erhalten Sie einen Ausdruck mit sämtlichen Einstellungen.

Settings (Status Report): Es werden sämtliche Geräteeinstellungen wie z.B.

Geschwindigkeit, Transferbandmaterial etc. ausgedruckt.

Bar codes (Barcodes): Es werden alle verfügbaren Barcodes ausgedruckt.

Fonts (Fonts): Es werden alle Vektor und Bitmap Fonts ausgedruckt.

Taste: 

Input: 11111111
Output: 00000000

Input/Output (Input/Output):

Anzeige der Signalpegel, die angeben bei welchem Signal der Druck gestartet wird.

0 - Low; 1 - High

Taste: 

Diagnostic
Enter

Diagnostic (Diagnose):Taste  drücken, um in das Diagnose Menü zu gelangen.Taste: 

EncProf	NoOfProf
Off	10

Encoder profiling (Drehgeber Profiling):

Die Drehgeber Werte mit Druckstart in Logging Dateien werden auf der CF Card aufgezeichnet. Anhand dieser Daten kann ein grafisches Schaubild der Drehgeberkurve erstellt werden.

Taste: 

DiaRU	DiaRW
68mm	655mm

Roller diameter (Transferbandrollen Durchmesser):**DiaRW** = Durchmesser der Transferband Aufwickelrolle.**DiaRU** = Durchmesser der Transferband Abwickelrolle.Taste: 

Enc. Average
100

Encoder average (Drehgeber Signale):

Anzahl der Werte über die die Drehgeber-Signale gemittelt werden.

Taste: 

IgnrStrt	IntPrts
123	456

Diagnostic - Counter (Diagnose - Zähler):**IgnrStrt** = Zähler für ignorierte Startsignale.**IntPrts** = Zähler für abgebrochene Druckaufträge.Wählen Sie mit dem Cursor den Wert aus über den Sie weitere Informationen möchten und drücken Sie die Taste .Taste: 

Njb	Nrd	Prt
+000	+999	+999

NJb =No job (Kein Druckauftrag):

Zähler für ignorierte Startsignale weil der Druckauftrag nicht aktiv war.

NRd = Not ready (Nicht bereit):

Zähler für ignorierte Startsignale weil der Druckauftrag nicht bereit war (gestoppt oder Fehlermeldung).

Prt = Printing (Drucken):

Zähler für ignorierte Startsignale während das Gerät druckt/tätig ist.

Taste: 

MS/I	ItfI	SpdS
+000	+999	+999

MS/I = Manual stopped/interrupted (Manuell gestoppt/abgebrochen):

Stopp Taste auf der Folientastatur, Panel oder in einem Programm wurde gedrückt.

ItfI = Interface interrupted (Schnittstelle abgebrochen):

Der Druckauftrag wurde abgebrochen weil neue Daten über eine Schnittstelle empfangen wurden.

SpdS = Speed stopped (Geschwindigkeit angehalten):

Der Druckauftrag wurde abgebrochen weil die gemessene Druckgeschwindigkeit zu langsam war.

Taste: 

On/Offline
Aus

Online/Offline (Online/Offline):Ist die Funktion aktiviert, kann mit der Taste  zwischen Online und Offline Mode gewechselt werden.

Standard: Aus

Online (Online): Daten können über Schnittstellen empfangen werden. Die Tasten derFolientastatur sind nur aktiv, wenn mit der Taste  in den Offline Mode gewechselt wurde.**Offline (Offline):** Die Tasten der Folientastatur sind wieder aktiv aber empfangene Daten werden nicht mehr abgearbeitet. Wenn das Gerät wieder im Online Mode ist, werden wieder neue Druckaufträge empfangen.Taste: 

TRB	Vorwarnung
Ein	ø 40 v:100

Transfer ribbon prior warning (Transferband Vorwarnung):

Vor dem Ende des Transferbands wird ein Signal über einen Steuerausgang ausgegeben.

Warning diameter (Vorwarnung Durchmesser):

Einstellung des Transferbandvorwarnungsdurchmessers.

Wird an dieser Stelle ein Wert in mm eingegeben, wird bei Erreichen dieses Durchmessers (gemessen an der Transferbandrolle) ein Signal über einen Steuerausgang gegeben.

v = reduced speed (reduzierte Druckgeschwindigkeit):

Einstellung der reduzierten Druckgeschwindigkeit. Diese kann in den Grenzen der normalen Druckgeschwindigkeit eingestellt werden.

-: Keine reduzierte Druckgeschwindigkeit

0: Drucker bleibt bei Erreichen des Vorwarndurchmessers mit 'Transferbandfehler' stehen.

Main Menu (Grundmenü)

Nach Einschalten des Direktdruckwerks ist folgende Anzeige auf dem Display zu sehen:



<pre>* DC c107-12K * 14/09/05 10:16</pre>	<p>Erste Zeile = Grundmenü Zweite Zeile = aktuelles Datum und Uhrzeit</p>
Taste: <input type="radio"/>	
<pre>* DC c107-12K * V1.44</pre>	Zweite Zeile = Versionsnummer der Firmware
Taste: <input type="radio"/>	
<pre>* DC c107-12K * Build 0201</pre>	Zweite Zeile = Build Version der Software
Taste: <input type="radio"/>	
<pre>* DC c107-12K * Jun 2 2005</pre>	Zweite Zeile = Erstelldatum der Firmware
Taste: <input type="radio"/>	
<pre>* DC c107-12K * 10:37:34</pre>	Zweite Zeile = Uhrzeit der Firmware Versionserstellung
Taste: <input type="radio"/>	
<pre>* DC c107-12K * B-Font: V5.01</pre>	Zweite Zeile = Fontversion der Bitmap Fonts
Taste: <input type="radio"/>	
<pre>* DC c107-12K * V-Font: V1.01</pre>	Zweite Zeile = Fontversion der Vektor Fonts
Taste: <input type="radio"/>	
<pre>* DC c107-12K * FPGA V1.4.0 T9</pre>	Zweite Zeile = Versions-Nummern der beiden FPGAs (P = Druckkopf; I = I/O)
Taste: <input type="radio"/>	
<pre>* DC c107-12K * 16 MB Memory</pre>	Zweite Zeile = Speicherkapazität des Gerätes in MB
Taste: <input type="radio"/>	
<pre>* DC c107-12K * 8 MB FLASH</pre>	Zweite Zeile = Speichergröße des FLASH in MB
Taste: <input type="radio"/>	
<pre>* DC c107-12K * A0 MO V.1.3.1 AB</pre>	Zweite Zeile = Versionsnummer für den ersten Prozessor (Motoransteuerung)
Taste: <input type="radio"/>	
<pre>* DC c107-12K * A1 MO V.1.3.1 AB</pre>	Zweite Zeile = Versionsnummer für den zweiten Prozessor (Motoransteuerung)
Taste: <input type="radio"/>	
<pre>* DC c107-12K * A2 IO V.1.3.1 AB</pre>	Zweite Zeile = Versionsnummer für den dritten Prozessor (I/O Überwachung)

CF Card (CF Karte)

Select layout (Layout auswählen)

Tastenfolge: 

```
→layout 01 0
A:\STANDARD
```

Tasten  und  drücken, um das gewünschte Layout im STANDARD Verzeichnis auszuwählen.

Taste  drücken, um das Layout auszuwählen.

Anzahl der Layouts, die gedruckt werden sollen, auswählen.

Taste  drücken, um Druckauftrag zu starten.

```
Druck Start
Anzahl: 12345
```

Load file (Datei laden)

Tastenfolge: , 

```
CF Funktionen
Datei laden
```

Taste: 

```
□→ .. <
A:\STANDARD
```

Gewünschte Datei auswählen und die Auswahl mit  bestätigen.

Taste  drücken und gewünschte Stückzahl eingeben.

Taste  drücken, um die Auswahl zu bestätigen und der Druckauftrag wird über ein externes Signal (Input 1, PIN 1 und PIN 4) ausgelöst.

Save layout (Layout speichern)

Tastenfolge: , , 

```
CF Funktionen
Layout speichern
```

Taste: 

```
Datei existiert
überschreiben?
```

Verzeichnis bzw. Layout auswählen das gespeichert werden soll und Auswahl mit  bestätigen.

Taste  drücken, um die Abfrage zu bestätigen und das Layout wird gespeichert.

Save configuration (Konfiguration speichern)

Tastenfolge: , , , 

```
CF Funktionen
Konf. speichern
```

Standardmäßig wird der Dateiname config.cfg vorgeschlagen. Dieser kann durch den Anwender geändert werden. In dieser Datei werden die Parameter des Druckmoduls gespeichert, die nicht dauerhaft im internen Flash abgelegt werden.

Taste  drücken, um den Speichervorgang auszulösen.

Change directory (Verzeichnis wechseln)

Tastenfolge: , , , , 



```
CF Funktionen
Verz. wechseln
```

Taste: 

```
←<.> M
A:\STANDARD\
```

In der unteren Zeile wird das momentan ausgewählte Verzeichnis angezeigt.

Tasten  und  drücken, um das Verzeichnis in die obere Zeile zu wechseln.

Tasten  und  drücken, um die möglichen Verzeichnisse anzuzeigen.

Taste  drücken, um das ausgewählte Verzeichnis zu übernehmen.

Delete file (Datei löschen)

Tastensequenz: , , , , , 

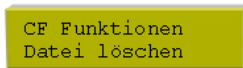



Verzeichnis bzw. Layout auswählen das gelöscht werden soll.

Taste  drücken, um die Auswahl zu bestätigen.

Format CF card (CF Karte formatieren)

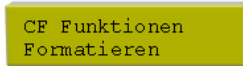
Tastensequenz: , , , , , , 



Taste: 

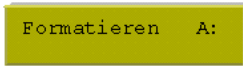

Taste  drücken, um das zu formatierende Laufwerk auszuwählen.

Taste  drücken, um die Auswahl zu bestätigen.

Beim Formatieren wird automatisch das Verzeichnis STANDARD angelegt.

Free memory space (Freier Speicherplatz)

Tastensequenz: , , , , , , , 

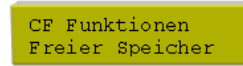

Der noch zur Verfügung stehende freie Speicherplatz auf der Compact Flash Card wird angezeigt.

Technische Daten

	Dynacode 53	Dynacode 107	Dynacode 128
Druckauflösung	300 dpi	300 dpi	300 dpi
Druckgeschwindigkeit			
Kontinuierlicher Modus	50 ... 800 mm/s	50 ... 600 mm/s	50 ... 450 mm/s
Intermittierender Modus	50 ... 600 mm/s	50 ... 600 mm/s	50 ... 600 mm/s
Rückfahrgeschwindigkeit	nur intermittierender Modus: max. 600 mm/s		
Druckbreite	53,3 mm	106,6 mm	128 mm
Max. Drucklänge			
Kontinuierlicher Modus	6000 mm	3000 mm	3000 mm
Intermittierender Modus	75 mm	75 mm	75 mm
Durchlassbreite Rahmen	gemäß Kundenwunsch		
Druckkopf	Corner Type	Corner Type	Corner Type
Schallemission (Messabstand 1 m)			
Mittlerer Schalleistungspegel	60 dB(A)	65 dB(A)	68 dB(A)
Transferband			
Farbseite	außen oder innen (Option)	außen oder innen (Option)	außen oder innen (Option)
Max. Rollendurchmesser	98 mm	82 mm	75 mm
Kerndurchmesser	25,4 mm / 1"	25,4 mm / 1"	25,4 mm / 1"
Max. Länge	900 m	600 m	450 m
Max. Breite	55 mm	110 mm	130 mm
Abmessungen (Breite x Höhe x Tiefe)			
Druckmechanik			
ohne Einbaurahmen	204 x 180 x 234 mm	204 x 180 x 290 mm	204 x 180 x 312 mm
mit Einbaurahmen	abhängig von der Durchlassbreite		
Ansteuerelektronik	240 x 125 x 332 mm Verbindungskabelsatz zur Mechanik 2,5 m		
Gewicht			
Druckmechanik	9,5 kg	11 kg	11,7 kg
Elektronik (inkl. Kabel)	5,5 kg	5,5 kg	5,5 kg
Elektronik			
Prozessor	High Speed 32 Bit		
Arbeitsspeicher (RAM)	16 MB / 64 MB (auf Anfrage)		
Steckplatz	für Compact Flash Karte Typ I		
Batterie	für Echtzeituhr (Datenspeicherung bei Netzabschaltung)		
Warnsignal	Akustisches Signal bei Fehler		
Schnittstellen			
Seriell	RS-232C (bis 115200 Baud)		
Parallel	Centronics		
Ethernet	10/100 Base T		
USB	1.1		
Anschlusswerte			
Pneumatikanschluss	min. 6 bar trocken und ölfrei		
Nennspannung	110 ... 230 V / 50 ... 60 Hz		
Nennstrom	230 V / 1,5 A – 110 V / 3 A		
Sicherungswerte	230 V / 2 AT – 110 V / 4 AT		
Betriebsbedingungen			
Temperatur	5 ... 40 °C		
Relative Feuchte	max. 80 % (nicht kondensierend)		

Bedienfeld	
Tasten	Testdruck, Funktionsmenü, Stückzahl, CF Karte, Feed, Enter, 4 x Cursor
LCD-Anzeige	Grafikdisplay 132 x 32 Pixel grüne Hintergrundbeleuchtung
Einstellungen	
	Datum, Uhrzeit, Schichtzeiten 11 Spracheinstellungen (weitere auf Anfrage) Geräteparameter, Schnittstellen, Passwortschutz
Überwachungen	
Druckstopp bei	Transferbandende / Layout-Ende / Druckkopf offen
Statusausdruck	Ausdruck zu Geräteeinstellungen wie z.B. Laufleistung, Lichtschranken-, Schnittstellen-, Netzwerkparameter Ausdruck der internen Schriftarten sowie aller unterstützter Barcodes
Schriften	
Schriftarten	6 Bitmap Fonts 8 Vektor Fonts/TrueType Fonts 6 Proportionale Fonts Weitere Schriftarten auf Anfrage
Zeichensätze	Windows 1250 bis 1257, DOS 437, 850, 852, 857 Es werden alle west- und osteuropäischen, lateinischen, kyrillischen, griechischen und arabischen (Option) Zeichen unterstützt. Weitere Zeichensätze auf Anfrage.
Bitmap Fonts	Größe in Breite und Höhe 0,8 ... 5,6 Vergrößerungsfaktor 2 ... 9, Ausrichtung 0°, 90°, 180°, 270°
Vektor Fonts / TrueType Fonts	Größe in Breite und Höhe 1 ... 99 mm Vergrößerungsfaktor stufenlos Ausrichtung 0°, 90°, 180°, 270°
Schriftattribute	Abhängig von der Schriftart fett, kursiv, invers, vertikal
Zeichenabstand	Variabel
Barcodes	
1D Barcodes	CODABAR, Code 128, Code 2/5 interleaved, Code 39, Code 39 extended, Code 93, EAN 13, EAN 8, EAN ADD ON, GS1-128, Identcode, ITF 14, Leitcode, Pharmacode, PZN 7 Code, PZN 8 Code, UPC-A, UPC-E
2D Barcodes	Aztec Code, CODABLOCK F, DataMatrix, GS1 DataMatrix, MAXICODE, PDF 417, QR Code
Composite Barcodes	GS1 DataBar Expanded, GS1 DataBar Limited, GS1 DataBar Omnidirectional, GS1 DataBar Stacked, GS1 DataBar Stacked Omnidirectional, GS1 DataBar Truncated
	Alle Barcodes sind in Höhe, Modulbreite und Ratio variabel Ausrichtung 0°, 90°, 180°, 270° Wahlweise Prüfziffer und Klarschriftausdruck
Software	
Konfiguration	ConfigTool
Prozess Steuerung	NiceLabel
Gestaltungssoftware	Labelstar Office Lite Labelstar Office
Windows Druckertreiber	Windows XP® 32/64 Bit, Windows Vista® 32/64 Bit Windows 7® 32/64 Bit, Windows 8® 32/64 Bit Windows 8.1® 32/64 Bit, Windows Server 2003® (R2) 32/64 Bit Windows Server 2008® 32/64 Bit, Windows Server 2008® (R2) 64 Bit Windows Server 2012® 64 Bit, Windows Server 2012® (R2) 64 Bit

Technische Änderungen vorbehalten.

Reinigung und Wartung



GEFAHR!

Lebensgefahr durch Stromschlag!

⇒ Vor allen Wartungsarbeiten Direktdruckwerk vom Stromnetz trennen.

Druckkopf reinigen



HINWEIS!

Für die Reinigung des Geräts sind persönliche Schutzeinrichtungen wie Schutzbrille und Handschuhe empfehlenswert.

Während des Drucks kommt es zu Verunreinigungen am Druckkopf z.B. durch Farbpartikel des Transferbandes. Deshalb ist es sinnvoll und notwendig, den Druckkopf in gewissen Zeitabständen, abhängig von Betriebsstunden und Umgebungseinflüssen wie Staub usw., zu reinigen.



VORSICHT!

Beschädigung des Direktdruckwerks!

- ⇒ Keine scharfen oder harten Gegenstände zur Reinigung des Druckkopfs verwenden.
- ⇒ Glasschutzschicht des Druckkopfs nicht berühren.

- Transferbandkassette entfernen.
- Druckkopfoberfläche mit einem in reinem Alkohol getränktem Wattestäbchen reinigen.
- Vor Inbetriebnahme des Direktdruckwerks, Druckkopf 2 bis 3 Minuten trocknen lassen.



HINWEIS!

Die Handhabungsvorschriften zur Verwendung von Isopropanol (IPA) sind zu beachten. Bei Kontakt mit der Haut oder den Augen mit fließendem Wasser gründlich auswaschen. Bei anhaltender Reizung Arzt aufsuchen. Für gute Belüftung sorgen.

Druckkopf austauschen



VORSICHT!

Beschädigung des Druckkopfs durch elektrostatische Entladungen oder mechanische Einflüsse!

- ⇒ Gerät auf geerdeter leitfähiger Unterlage aufstellen.
- ⇒ Körper erden, z.B. durch Anlegen eines geerdeten Handgelenkgurts.
- ⇒ Kontakte an den Steckverbindungen nicht berühren.
- ⇒ Druckleiste nicht mit harten Gegenständen oder der Hand berühren.

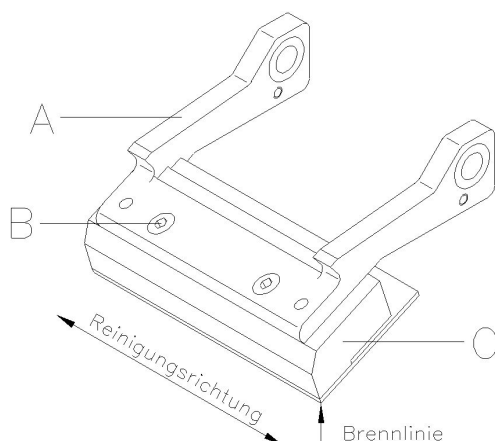

Druckkopf ausbauen

- Transferbandkassette entfernen.
- Druckkopfeinheit in geeignete Serviceposition schieben.
- Druckkopfhalter (A) leicht nach unten drücken bis ein Inbusschlüssel (SW 2,5) in die Schrauben (B) eingeführt werden kann.
- Schrauben (B) entfernen und Druckkopf (C) entnehmen.
- Steckverbindung auf der Rückseite vom Druckkopf abziehen.

Druckkopf einbauen

- Steckverbindungen an den neuen Druckkopf anstecken.
- Druckkopf im Druckkopfhalter (A) positionieren, sodass die Mitnehmer in die entsprechenden Bohrungen im Druckkopfhalter (A) greifen.
- Druckkopfhalter (A) mit einem Finger leicht auf der Druckwalze halten und korrekte Lage des Druckkopfs (C) prüfen.
- Mit dem Sechskantschlüssel Schraube (B) einschrauben und festziehen.
- Transferbandmaterial wieder einlegen.
- In den 'Service Funktionen/Dot Widerstand' den Widerstandswert des neuen Druckkopfs eingeben. Der Wert ist auf dem Typenschild des Druckkopfs zu finden.
- Position des Druckkopfs mittels eines Testdrucks prüfen.

Winkeleinstellung (intermittierender Modus)

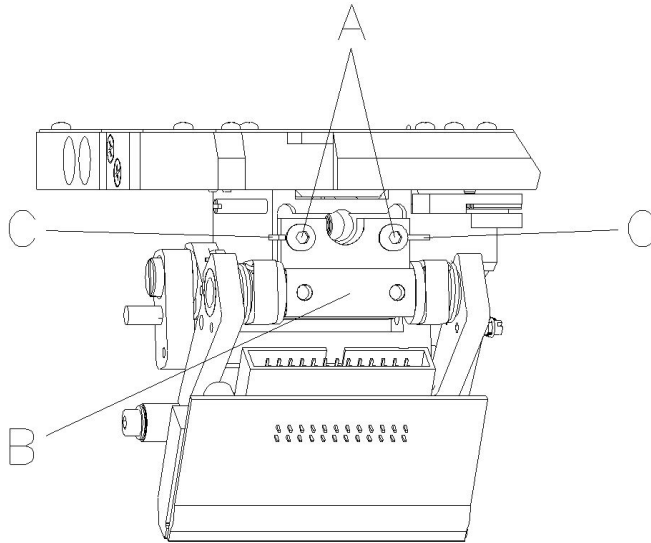

Der Einbauwinkel des Druckkopfes beträgt standardmäßig 26° zur Druckfläche. Fertigungstoleranzen des Druckkopfes und der Mechanik können jedoch einen anderen Winkel erforderlich machen.



VORSICHT!

Beschädigung des Druckkopfes durch ungleiche Abnutzung!
 Größerer Verschleiß von Transferband durch schnelleres Reißen.
 ⇒ Werkseinstellung nur in Ausnahmefällen verändern.

- Innensechskantschrauben (A) leicht lösen.
- Stellstück (B) verschieben, um den Winkel zwischen Druckkopf und Druckkopfhalter zu verstellen.
 Verschieben nach unten = Winkel verkleinern
 Verschieben nach oben = Winkel vergrößern
- Innensechskantschrauben (A) wieder anziehen.
- Druckauftrag über ca. 3 Layouts starten und korrekten, faltenlosen Bandlauf kontrollieren.



HINWEIS!

Die angebrachten Schlitz (C) dienen zur Positionskontrolle. Auf eine möglichst parallele Einstellung ist zu achten.

Instrucciones abreviadas y
recomendaciones de seguridad

Español

Copyright by Carl Valentin GmbH

Las indicaciones sobre el contenido del envío, el aspecto, las medidas, el peso se corresponden con nuestros conocimientos en el momento de la impresión de este documento.

Reservado el derecho a efectuar modificaciones.

Reservados todos los derechos, incluidos los de la traducción.

Prohibido reelaborar ningún fragmento de esta obra mediante sistemas electrónicos, así como multicopiarlo o difundirlo de cualquier modo (impresión, fotocopia o cualquier otro procedimiento) sin previa autorización de la empresa Carl Valentin GmbH.

Debido al constante desarrollo de los aparatos puede haber diferencias entre la documentación y el aparato.

La edición actual puede encontrarse bajo: www.carl-valentin.de.

Marcas comerciales (Trademarks)

Todas las marcas o sellos comerciales nombrados son marcas o sellos registrados del correspondiente propietario y, en algunos casos, no tendrán un marcado especial. De la falta de marcado no se puede deducir que no se trate de una marca o sello registrado/a.

Los módulos de impresión directa Carl Valentin cumplen las siguientes directrices de seguridad:

- CE** Directiva CE de máquinas (98/37/CE)
- Directiva CEE sobre baja tensión (2006/95/CE)
- Directiva CE sobre compatibilidad electromagnética (89/336/CEE)



Carl Valentin GmbH

Postfach 3744
78026 Villingen-Schwenningen
Neckarstraße 78 – 86 u. 94
78056 Villingen-Schwenningen

Phone +49 (0)7720 9712-0
Fax +49 (0)7720 9712-9901

E-Mail info@carl-valentin.de
Internet www.carl-valentin.de

Contenido

Indicaciones para su empleo	36
Indicaciones de seguridad	36
Eliminación no contaminante	37
Condiciones de funcionamiento	38
Desembalaje del módulo	41
Contenido del material entregado	41
Conexión del módulo	41
Preparación para la puesta en funcionamiento	41
Control de impresión	41
Puesta en funcionamiento	41
Colocación del casete de cinta transferencia	42
Print Settings (Inicialización de impresión)	43
Machine Parameters (Parámetros de máquina)	43
Layout Parameters (Diseño)	44
Ribbon Save (Ahorro cinta) - Modo continuo	45
Ribbon Save (Ahorro cinta) - Modo intermitente	47
Device Settings (Parámetros del aparato)	48
I/O Parameters (Parámetros I/O)	49
Network (Red)	49
Remote Console (Consola remota)	49
Interface (Puertos)	50
Emulation (Emulación)	50
Date & Time (Fecha & Hora)	51
Service Functions (Funciones de asistencia técnica)	52
Main Menu (Menú principal)	54
Tarjeta Compact Flash	55
Datos técnicos	57
Limpieza del cabezal de impresión	59
Cambio del cabezal de impresión	59
Ajuste del ángulo (modo intermitente)	60

Indicaciones para su empleo

- El módulo de impresión directa ha sido construida conforme al estado de la técnica y a las reglas de seguridad técnica vigentes. No obstante, durante la utilización pueden producirse serios peligros para el usuario o para terceros, así como daños a el módulo de impresión directa y otros daños materiales.
- Únicamente se debe utilizar el módulo de impresión directa en perfectas condiciones técnicas, de una manera adecuada, teniendo en cuenta la seguridad y los peligros que se corren, y de acuerdo con las instrucciones de manejo. En especial deben resolverse inmediatamente los problemas que afecten a la seguridad.
- El módulo de impresión directa está diseñada exclusivamente para imprimir materiales adecuados y autorizados por el fabricante. Cualquier otro uso no contemplado en lo anterior se considera contrario a lo prescrito. El fabricante/proveedor no asume ninguna responsabilidad por los daños resultantes de un uso incorrecto.
- También forma parte del uso adecuado seguir las instrucciones de manejo y cumplir los requisitos/normas de mantenimiento indicados por el fabricante.

Indicaciones de seguridad

- El módulo de impresión directa está diseñada para funcionar con redes eléctricas con una corriente alterna de 110 V hasta 230 V. Conectar el módulo de impresión directa únicamente a tomas de corriente con contacto con conductor de protección a tierra.



¡NOTA!

Cuando se cambie la tensión, el valor del fusible deberá ser adaptado en concordancia (vease 'Datos Técnicos').

- Enchufe el módulo de impresión directa sólo a líneas de baja tensión.
- Antes de establecer o soltar conexiones debe desenchufarse todos los aparatos implicados (ordenador, módulo, accesorios).
- Utilizar el módulo de impresión directa en entornos secos y sin humedad (salpicaduras de agua, vapor, etc.).
- No use el módulo de impresión directa en atmósferas explosivas o cerca de líneas de alta tensión.
- Utilizar el aparato únicamente en entornos protegidos de polvo de lijar, virutas metálicas y cuerpos extraños similares.
- En caso de que limpie o entretenga el módulo de impresión directa con la tapa abierta, debe tenerse en cuenta que ni la ropa, el pelo o las joyas o similares entren en contacto con las partes rotativas que están al descubierto.



¡NOTA!

Con la unidad de impresión abierta (debido a su diseño) no se cumplen los requisitos de la norma EN60950-1 de prevención contra incendios. Esto debe tenerse en cuenta a la hora de instalar el módulo de impresión directa en la máquina.

- El subconjunto de impresión puede calentarse durante el funcionamiento. No tocarlo durante el funcionamiento y dejarlo enfriar antes de efectuar un cambio de material, de desmontarlo o ajustarlo.
- Realizar sólo las acciones descritas en este manual de usuario. Las acciones no incluidas en este manual deberán ser realizadas únicamente por el fabricante o en coordinación con el fabricante.
- La interferencia de módulos electrónicos no autorizados o su software pueden causar problemas de funcionamiento.
- Las modificaciones y alteraciones no autorizadas realizadas en el aparato pueden poner en peligro su seguridad operacional.
- Siempre haga los trabajos de servicio y mantenimiento en un taller adaptado a tal uso, donde el personal tenga conocimientos técnicos y herramientas requeridas para hacer los trabajos necesarios.
- Hay adhesivos de atención en el módulo de impresión directa que le alertan de los peligros. Por lo tanto, no retire los adhesivos de atención para que usted u otra persona estén al tanto de los peligros o posibles daños.
- Cuando se monte la máquina, se debe integrar el módulo de impresión directa en el circuito de parada de emergencia.
- Antes de poner en marcha la máquina deberán montarse todos los dispositivos de protección separadores.



¡PELIGRO!

¡Peligro de muerte o daños corporales graves por electricidad!

⇒ No abra la cubierta del módulo de impresión directa.

Eliminación no contaminante

Los fabricantes de aparatos B2B están obligados desde el 23/03/2006 a recibir de vuelta y reciclar los residuos de aparatos fabricados después del 13/08/2005. Está terminantemente prohibido deponer dichos residuos en puntos de recolección comunales. Únicamente el fabricante está autorizado para reciclarlos y eliminarlos en forma organizada. Por ello, en el futuro los productos Valentin que lleven la identificación correspondiente podrán ser retornados a Carl Valentin GmbH. Los residuos de aparatos serán eliminados entonces en forma apropiada.

Con ello, Carl Valentin GmbH asume oportunamente todas las obligaciones en el marco de la eliminación de residuos de aparatos, posibilitando de ese modo también la venta sin obstáculos de los productos. Únicamente podemos aceptar aparatos enviados francos de porte.

Puede obtenerse más información leyendo la directiva RAEE o nuestra página web www.carl-valentin.de.

Condiciones de funcionamiento

Antes de la puesta en marcha de nuestro módulo y durante su uso, deberá comprobar que se cumplen las condiciones de funcionamiento aquí descritas. Sólo así quedará garantizado un funcionamiento del aparato en condiciones de seguridad y libre de interferencias.

Por favor, lea atentamente las condiciones de funcionamiento.

En caso de que necesite consultar acerca de las aplicaciones prácticas de las condiciones de servicio, póngase en contacto con nosotros o con el servicio de asistencia técnica que le corresponda.

Condiciones generales

Los equipos deben transportarse y almacenarse sólo en su embalaje original.

Los equipos no pueden colocarse ni ponerse en funcionamiento antes de que se hayan cumplido todas las condiciones de servicio.

Está prohibida la puesta en marcha hasta comprobar que, siempre que se precise, la máquina en donde va a incorporarse la cuasi máquina cumple las disposiciones de la directiva 2006/42/CE.

La puesta en marcha, programación, manejo, limpieza y cuidado de nuestros equipos solo puede llevarse a cabo tras leer cuidadosamente nuestras instrucciones.



¡NOTA!

Le recomendamos que asista con frecuencia y repetidamente a cursos de formación. El contenido de los cursos son los capítulos 'Condiciones de funcionamiento', 'Colocar el material' y el capítulo 'Mantenimiento y limpieza'.

Las observaciones son de aplicación asimismo para los equipos de terceros suministrados por nosotros.

Sólo pueden utilizarse repuestos y piezas de recambio originales.

Para cualquier información sobre las piezas de recambio/desgaste, diríjase al fabricante.

Advertencias respecto a la batería de litio

Para la batería de litio (tipo CR 2032), que se encuentra en la CPU del módulo, es válida la disposición acerca de baterías, que prevé que las baterías cargadas deben depositarse en los contenedores para baterías usadas disponibles en los comercios o en los organismos públicos responsables de los residuos. En el caso de que las baterías no estuvieran completamente descargadas, se deben tomar medidas para evitar cortocircuitos. En la puesta fuera de servicio del módulo la batería debe eliminarse en los contenedores apropiados en todo caso separadamente del módulo.



¡PELIGRO!

¡Peligro de muerte debido a explosión!

⇒ No emplear herramientas conductoras.

Condiciones del lugar de emplazamiento

El lugar de instalación debe ser liso y sin vibraciones. Deben evitarse las corrientes de aire.

Los aparatos se dispondrán de tal manera que se asegure su óptimo mantenimiento y accesibilidad.

Instalación de la fuente de alimentación

La instalación de la fuente de alimentación para conectar nuestros módulos debe efectuarse de conformidad con la regulación y los acuerdos internacionales aplicables, y las disposiciones de ellos derivadas. En particular, debe efectuarse atendiendo a las recomendaciones de una de las tres comisiones siguientes:

- Comisión Internacional de Electrotécnica (IEC)
- Comité Europeo de Normalización Electrotécnica (CENELEC)
- Federación de Electrotécnicos Alemanes (VDE)

Nuestros aparatos están diseñados de acuerdo con lo establecido por la VDE para el tipo de prevención (Schutzklasse I), y deben conectarse a un conector puesto a tierra. La fuente de alimentación debe tener un conector de tierra o aterrizado, para eliminar interferencias internas en el voltaje.

Datos técnicos de la fuente de alimentación

Tensión y frecuencia de red:	Véase placa de características
Tolerancia permitida de tensión de red:	+6% hasta -10% del valor nominal
Tolerancia permitida de frecuencia de red:	+2% hasta -2% del valor nominal
Factor de distorsión no lineal permitido:	<=5%

Medidas anti-interferencia:

En el caso de que la red se encuentre fuertemente contaminada (p.ej. en el caso de emplearse instalaciones controladas por tiristores), el cliente deberá tomar medidas anti-interferencia. Como medidas pueden tomarse, por ejemplo, las indicadas a continuación:

- Instale una toma de corriente independiente para nuestros aparatos.
- En el caso de problemas, instale un transformador de separación capacitado para desacoplamiento, u otro supresor de interferencias similar, en nuestros aparatos.

Radiación parásita e inmunidad a las interferencias

Interferencia emitida según EN 61000-6-4: 08-2002

- Corriente parásita en líneas de alimentación según EN 55022: 09-2003
- Intensidad del campo parasitario según EN 55022: 09-2003
- Corrientes armónicas (retroalimentación a la red) según EN 6100—3-2: 09-2005
- Flicker según EN 61000-3-3: 05-2002

Inmunidad a las interferencias según EN 61000-6-2: 03-2006

- Inmunidad a las interferencias frente a la descarga de energía estática según EN 61000-4-2: 12-2001
- Campos electromagnéticos según EN 61000-4-3: 11-2003
- Inmunidad a las interferencias frente a transientes o descargas eléctricas rápidas (Burst) según EN 61000-4-4: 07-2005
- Inmunidad a las interferencias frente a oscilaciones bruscas (sobretensión) según EN 61000-4-5: 12-2001
- Tensión HF según EN 61000-4-6: 12-2001
- Cortes y caídas de tensión según EN 61000-4-11: 02-2005



¡NOTA!

Este es un dispositivo de tipo A. Este aparato puede producir radiointerferencias en zonas habitadas. En dicho caso, se podrá exigir al usuario que tome las medidas apropiadas y que se haga responsable de las mismas.

Seguridad en las máquinas

- EN 415-2 – Seguridad de máquinas empaquetadoras
- EN 60204-1:2006 – Seguridad de las máquinas – Equipo eléctrico de las máquinas – Parte 1

Conexión a líneas de maquinaria exterior

Todas las líneas de conexión deben efectuarse por medio de cables apantallados. La malla de la pantalla debe estar, en una superficie amplia, en conexión con la superficie de la caja del enchufe por ambas caras.

No debe instalarse ninguna conexión paralela a la conexión eléctrica. Si no se puede evitar una conexión paralela, debe observarse una separación mínima de 0,5 metros de la conducción eléctrica.

Temperatura ambiente de la conducción: De -15 a +80 °C.

Sólo está autorizado a conectar aparatos que cumplan los requisitos establecidos para los circuitos de tensión extra-baja de seguridad 'Safety Extra Low Voltage' (SELV) . En general, estos serán los que se hayan comprobado según la norma EN 60950.

Instalación de líneas de datos

Los cables de la terminal deben estar íntegramente apantallados y provistos de enchufes con carcasas de metal o metalizadas. Es preciso el uso de cables y enchufes apantallados con el fin de evitar la emisión y recepción de interferencias eléctricas.

Cables permitidos

Cable apantallado: 4 x 2 x 0,14 mm² (4 x 2 x AWG 26)
 6 x 2 x 0,14 mm² (6 x 2 x AWG 26)
 12 x 2 x 0,14 mm² (12 x 2 x AWG 26)

El cableado de emisión y recepción debe ser de tipo par trenzado apantallado en cada caso.

Longitud máx. del cable: en la interfaz V 24 (RS232C) - 15 m a máx. 19200 bds
 en Centronics - 3 m
 en USB - 3 m
 en la Ethernet - 100 m

Ventilación por convección

Para evitar un calentamiento indeseado del aparato, el aire debe de circular libremente alrededor del aparato.

Valores límite

Clase de protección según IP:	20
Temperatura ambiental °C (servicio):	Min. +5 Máx. +40
Temperatura ambiental °C (transporte, almacenamiento):	Min. -25 Máx. +60
Humedad relativa del aire % (servicio):	Máx. 80
Humedad relativa del aire % (transporte, almacenamiento):	Máx. 80 (no se permite la condensación)

Garantía

No nos hacemos responsables de ningún daño derivado de:

- Incumplimiento de las condiciones de funcionamiento e instrucciones de uso.
- Instalación eléctrica defectuosa del entorno.
- Modificaciones en la construcción de nuestros aparatos.
- Programación y manejo incorrectos.
- No haber realizado debidamente el aseguramiento de los datos.
- Utilización de repuestos y piezas de recambio no originales.
- Desgaste natural y por uso del aparato.

Cuando reinstale o re programe los módulos, controle la nueva configuración mediante una prueba de funcionamiento y de impresión. Así evitará efectos, interpretaciones y rotulación equivocados.

Los aparatos deben ser utilizados únicamente por personal debidamente adiestrado al efecto.

Vigile el uso adecuado de nuestros productos y realice a menudo cursillos de formación.

No garantizamos que todos los modelos dispongan de todas las características descritas en este manual. Dado nuestro esfuerzo por un desarrollo y mejora continuados de nuestros productos, cabe la posibilidad de que se modifique algún dato técnico sin comunicarlo previamente.

Debido a la continua mejora de nuestros productos y a las disposiciones específicas para cada país, las imágenes y ejemplos del manual pueden diferir de los modelos suministrados.

Por favor, preste atención a la información acerca de los productos de impresión autorizados, y siga las instrucciones de mantenimiento del aparato para evitar daños y desgaste prematuro del mismo.

Nos hemos esforzado en redactar este manual de manera comprensible para proporcionarle la máxima información posible. Si tuviera cualquier duda o detectara algún error les rogamos nos lo haga saber para que podamos seguir mejorando este manual.

Desembalaje del módulo

- ⇒ Al sacar el módulo de impresión directa de la caja.
- ⇒ Controle que el módulo de impresión directa no se haya dañado durante el transporte.
- ⇒ Compruebe que el envío está completo.

Contenido del material entregado

- Mecánica de impresión.
- Unidad de control.
- Cable de corriente.
- Cable de conexión (sensor, power).
- Mini-regulador.
- Manómetro.
- Tubo del aire comprimido.
- Empalme de tubos.
- Accesorios E/S (conector hembra por E/S, cable E/S 24).
- 1 rollo de cinta de transferencia.
- Canuto de cinta vacío, montado sobre eje enrollador de cinta de transferencia.
- Hoja de limpieza por el cabezal.
- Documentación.
- CD con controladores.



¡NOTA!

Conserve el embalaje original para un transporte posterior.

Conexión del módulo

El módulo está equipada con un cables de largo alcance. El aparato puede funcionar sin manipulación ninguna con una tensión de red de 110-230 V / 50-60 Hz.



¡ATENCIÓN!

Daño al equipo debido a corrientes de cierre indefinidas.

⇒ Antes de conectar a la toma, colocar el enchufe en la posición 'O'.

- ⇒ Enchufe el cable de red al casquillo conexión a la red.
- ⇒ Enchufe el cable de red a la toma de corriente puesta a tierra.



¡NOTA!

Si la puesta a tierra no es suficiente o no existe, pueden surgir averías durante el funcionamiento. Asegurarse de que todos los ordenadores conectados a el módulo de impresión directa así como el cable de unión estén puestos a tierra.

- ⇒ Una el módulo de impresión directa con el ordenador o l ared de ordenadores con un cable apropiado.

Preparación para la puesta en funcionamiento

- ⇒ Monte la mecánica de impresión.
- ⇒ Conecte todos los cables entre la mecánica de impresión y la unidad de control y asegúrelos para que no se aflojen de forma inadvertida.
- ⇒ Conecte la línea de aire comprimido.
- ⇒ Conecte el PC y la unidad de control a través de la interfaz del módulo.
- ⇒ Conecte la unidad de control y la máquina empaquetadora a través de los controles de entrada y de salida.
- ⇒ Conecte el cable de la red de la unidad de control.

Control de impresión

Dado que el módulo se encuentra siempre en modo de control, los trabajos de impresión se pueden transmitir a través de los interfaces disponibles (serial, paralelo, USB, o eventualmente Ethernet), pero no se podrán desencadenar a través de estos. La impresión se iniciará mediante una señal de inicio en el control de entrada del inicio de impresión. Para que la unidad de control reconozca cuando se puede realizar una señal de inicio, es posible y en general también importante, el seguimiento del estatus de impresión en la unidad de control.

Puesta en funcionamiento

Cuando ya se ha realizado todas las conexiones:

- ⇒ Tras conectar el aparato aparecerá en la pantalla el menú principal, y se mostrarán el tipo del módulo y la hora y fecha actuales.
- ⇒ Inserción del casete de la cinta de transferencia. Tras insertar el casete de la cinta de transferencia se procederá a medir la cinta de transferencia introducida y el cabezal de impresión se situará en posición de impresión.

Colocación del casete de cinta transferencia



¡AVISO!

Debido a que el fino recubrimiento del cabezal térmico de impresión o de otro componente electrónico pueden verse dañados debido a la descarga electrostática, la cinta de transferencia debe ser antiestática. El empleo de material inadecuado puede conducir a fallos de funcionamiento del módulo y provocará la cancelación de la garantía.

Tinta en el exterior



¡NOTA!

Antes de colocar una nueva cinta de transferencia, le recomendamos limpiar el cabezal de impresión con el limpiador de cabezal y de rodillos (97.20.002). Deben seguirse las instrucciones de manipulación para la utilización de alcohol isopropílico (IPA). En caso de contacto con la piel o los ojos, enjuagar bien con agua corriente. Si persiste la irritación, acuda a un médico. Asegúrese de que el lugar esté bien ventilado.

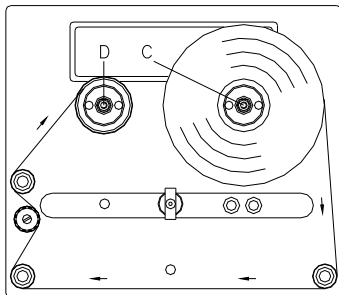
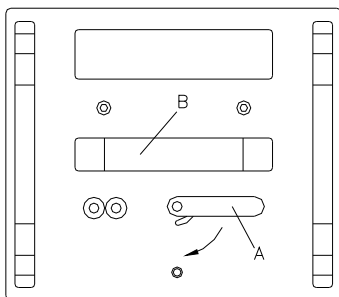

La imagen superior muestra un sistema de impresión de orientación izquierda. La colocación de una cinta de transferencia en un sistema de impresión derecha procede de manera análoga.

- Gire la palanca (A) 90° en el sentido de las agujas del reloj.
- Extraiga el casete de la cinta de transferencia tirando de ella por el asa (B) a través de la mecánica de impresión.
- Coloque una nueva cinta de transferencia (A) hasta que encaje en el dispositivo desbobinador (C).
- Coloque un cartucho vacío hasta que encaje en el dispositivo desbobinador (D).
- Inserte la cinta de transferencia conforme la imagen lo indica, y péguela con celo al cartucho vacío tensando la cinta haciendo girar el cartucho unas vueltas.
- Inserte de nuevo la cinta de transferencia en la mecánica de impresión y preste atención al hacerlo a evitar el desgarro de la cinta de impresión.
- Gire la palanca (A) 90° en el sentido contrario a las agujas del reloj.

Tinta en el interior

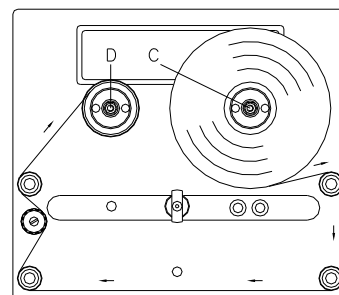
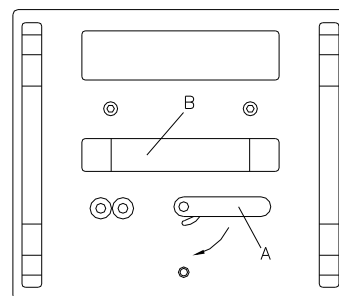

La imagen superior muestra un sistema de impresión de orientación izquierda. La colocación de una cinta de transferencia en un sistema de impresión derecha procede de manera análoga.

- Gire la palanca (A) 90° en el sentido de las agujas del reloj.
- Extraiga el casete de la cinta de transferencia tirando de ella por el asa (B) a través de la mecánica de impresión.
- Coloque una nueva cinta de transferencia (A) hasta que encaje en el dispositivo desbobinador (C).
- Coloque un cartucho vacío hasta que encaje en el dispositivo desbobinador (D).
- Inserte la cinta de transferencia conforme la imagen lo indica, y péguela con celo al cartucho vacío tensando la cinta haciendo girar el cartucho unas vueltas.
- Inserte de nuevo la cinta de transferencia en la mecánica de impresión y preste atención al hacerlo a evitar el desgarro de la cinta de impresión.
- Gire la palanca (A) 90° en el sentido contrario a las agujas del reloj.

Print Settings (Iniciación de impresión)

Secuencia de teclas: **F**

Menú funciones
Iniciación

Tecla:

Velocidad 200
Contraste 100

Solo modo intermitente - Speed (Velocidad):

Rango de valores: 50 mm/s ... 200 mm/s.

Contrast (Contraste):

Rango de valores: 10% ... 200%.

Tecla:

Control ribbon
On sensib. alta

Transfer ribbon control (Control de ribbon):

Se comprueba si la cinta de transferencia ha llegado al final, y que la cinta de transferencia no se haya rasgado en el rollo de bobinado.

Off: El control de la cinta de transferencia está desactivado, es decir, que el módulo continúa funcionando sin dar avisos de error.

On: El control de la cinta de transferencia está activado, esto es, el trabajo de impresión se verá interrumpido, y se mostrará un aviso de error en la pantalla.

strong sensibility (sensibilidad alta): El módulo reacciona inmediatamente al final de la cinta de transferencia.

weak sensibility (sensibilidad baja): El módulo reacciona aproximadamente tres veces más lento en el final de la cinta de transferencia.

Tecla:

Offset eje X
Offs (mm): -1.5

X-displacement (Offset eje X):

Indicación del desplazamiento en dirección X.

Rango de valores: -90.0 ... +90.0

Machine Parameters (Parámetros de máquina)

Modo continuo

Secuencia de teclas: **F**,

Manú funciones
Parám. máquina

Tecla:

Modo funcionam.
IO DY

Operating mode (Modo de funcionamiento):

Selección del modo de funcionamiento.

Tecla:

Offset impr.
(mm) 10.0

Print offset (Offset de impresión):

Indica la distancia del diseño al posición en la señal de inicio.

Rango de valores: 1 ... 999 mm

Tecla:

Pos. impresión
(mm) 20.0

Print position (Posición de impresión):

Posición del carril de impresión.

Rango de valores: 12 ... 93 mm

Tecla:

Diseño/ciclo
1

Layouts/cycle (Diseños/ciclo):

Indica el número de diseños a imprimir por largo de impresión.

Rango de valores: 1 hasta 25 diseños por ciclo.

Modo intermitente

Secuencia de teclas: **F**,

Manú funciones
Parám. máquina

Tecla:

Modo funcionam.
2 continuo

Operating mode (Modo de funcionamiento):

Selección del modo de funcionamiento.

Tecla:

Back-Speed mm/s
400

Back speed (Back-Speed):

Indica en mm/s la velocidad de retroceso de la mecánica del módulo tras finalizar la impresión.

Rango de valores: 50 ... 500 mm/s.

Tecla:

Offset impr.
(mm) 10.0

Print offset (Offset de impresión):

Indica la distancia del diseño al posición en la señal de inicio.

Rango de valores: 1 ... 999 mm

Tecla:

Pos. impresión
(mm) 20.0

Print position (Posición de impresión):

Posición del carril de impresión.

Rango de valores: 12 ... 93 mm

Modo continuo

Tecla: 

ChkSpeed On Strt
Off

Check speed on start (Verificación del inicio de la señal de impresión):

Verificación del inicio de la señal de impresión.

Tecla: 

Res. mm/360°
2000 166

Encoder resolution / material feed per encoder rotation (Resolución encoder / Avance de material por giro del encoder):

Muestra la resolución del encoder utilizado y el avance de material por giro del encoder en mm.

Tecla: 

Veloc. material
200 mm/s

Material speed (Velocidad del material):

Muestra la velocidad del material.

Modo intermitente

Tecla: 



Diseño/ciclo
1

Layouts/cycle (Diseños/ciclo):

Indica el número de diseños a imprimir por largo de impresión.

Rango de valores: 1 hasta 25 diseños por ciclo.

Layout Settings (Diseño)

Secuencia de teclas: **F**, , 

Menú funciones
Diseño

Tecla: 

Largo impr. mm
140.0

Tecla: 

Ancho: 20.0
Carriles: 4

Tecla: 

Material
Tipo 2

Tecla: 

Diseño espejo
Off

Tecla: 

Girar diseño
On

Tecla: 

Alineamiento
Izquierda

Print length (Largo de impresión):

Indica el camino que la mecánica de impresión debe recorrer hacia atrás. El largo de impresión depende del largo de la mecánica de impresión.

Column printing (Ancho de diseño / Número de carriles):

Indica el ancho de un diseño así como el número de diseño que se encuentran una al lado de la otra en el material a imprimir.

Material selection (Selección de material):

Selección de los diseños o del material de las cintas de transferencia, respectivamente.

Flip layout (Diseño espejo):

El eje de reflexión se encuentra en el centro del diseño. Si la anchura del diseño no ha sido transmitida al módulo de impresión, se utiliza el diseño predefinido, es decir, la anchura del cabezal del impresión. Por este motivo debe prestar atención a que el diseño sea tan ancho como el cabezal de impresión. De otro modo se pueden producir problemas en la colocación.

Rotate layout (Girar diseño):

El diseño se imprimirá de forma estándar con un ángulo de 0°. Si esta función se activa, el diseño se girará en 180° y se imprimirá en la orientación de la lectura.

Alignment (Alineamiento):

El alineamiento del diseño se realiza después del giro/reflexión, es decir el alineamiento es independiente del giro y la reflexión.

Left (Izquierda): El diseño se ajustará al margen izquierdo del cabezal de impresión

Centre (Centro): El diseño se ajustará al punto medio del cabezal de impresión (centrado)

Right (Derecha): El diseño se ajustará al margen izquierdo del cabezal de impresión

Ribbon Save (Ahorro cinta) - Modo continuo

Secuencia de teclas: **F**, , , 

Menú funciones
Ahorro cinta

Tecla: 

Mode Speed
Standard 600

Mode (Modo): Selección del tipo de ahorro cinta.

Off: Ahorro de cinta desconectada.

Standard (Estándar): Máxima capacidad de ahorro de cinta. Es decir, con este ajuste no se produce una pérdida de la cinta de transferencia (a excepción de una distancia de seguridad de 1 mm, a fin de que los errores de impresión no se impriman entremezclados).

SaveStrt (Memorizar señal inicio): Ninguna pérdida de señal de inicio. El módulo regula automáticamente la calidad del ahorro de cinta según requerimiento.

Speed (Velocidad): Fijación de la velocidad máxima de impresión. Sobre la base de este valor se realizan todos los cálculos necesarios.

Modo: Standard

R-Correction
-1 mm

Transfer ribbon correction (Corrección de ribbon):

0 mm = Se retrocede siempre hasta alcanzar un ahorro de cinta (no hay pérdida de cinta de transferencia)

Valor por defecto: + 1 mm

-xx mm = El retroceso puede reducirse.

+xx mm = El retroceso puede ampliarse.

Tecla: 

sa/mm cmin so/mm
303 1000 10

Performance information (Información sobre el rendimiento):

sa/mm: La mínima distancia posible entre dos impresiones con máximo ahorro de cinta.

cmin: Cantidad máxima de ciclos en ciclos por minuto.

so/mm: Indicación de la pérdida de ahorro de cinta.

Taste: 

ExpertParameters

Expert parameters (Parámetros del experto):

El menú está protegido por contraseña

Introducir la contraseña, pulsar la tecla  para confirmar la introducción y se visualizarán los siguientes parámetros:

Tecla: 

PhDownT REStartT
30 ms 10 ms

PhDownT = Printhead down time (Bajada del cabezal) in ms:

Es empleado por el algoritmo de ahorro de cinta para calcular el inicio del movimiento descendente del cabezal de impresión.

REStartT = Ribbon motor early start time (Tiempo de inicio del motor de ribbon) in ms:

Este valor se suma al tiempo de aumento del movimiento de la cinta de transferencia.

Indicación para el tiempo entre 'motor alcanza velocidad del material' y 'cabezal de impresión incandescente'.

Tecla: 

MinSpeed Calcoff
50 mm/s On

MinSpeed = Minimal print speed (Velocidad mínima de impresión):

Si se eleva la velocidad mínima de impresión, se eleva también el número máximo de los ciclos.

Calcoff = Print offset border calculation (Cálculo de offset impresión de borde):

Si el parámetro se coloca en off, puede introducirse un offset de impresión menor al requerido.

Tecla: 

PhUpT PhVReactT
20 ms 10 ms

PHUpT = Printhead up time (Tiempo de cabezal elevado):

Es empleado por el algoritmo de ahorro de cinta para calcular si se puede hacer un ahorro de cinta de campo o no.

PhVReactT = Valve reaction time (Tiempo de reacción de la válvula):

Se calcula cuándo iniciar el movimiento descendente del cabezal.

Tecla: 

RibMotStpDlayT
2 ms

RibMotStpDlayT = Ribbon motor stop delay time (Tiempo de retardo).

El tiempo de deceleración está en ms en los cuales el motor de la cinta de transferencia se mueve aún a velocidad constante antes de detenerse.

Tecla: 

FieldRS Rwind v
Normal 600mm/s

FieldRS = Field ribbon saving (Ahorro de ribbon en el campo):

Off: Optimización de campo desconectada.

PHOnly: Se mueve únicamente el cabezal de impresión. La cinta de transferencia no se detiene.

Normal: Se ejecuta el ahorro de cinta de campo únicamente cuando el motor de la cinta de transferencia es detenido por completo.

Strong: Se ejecuta el ahorro de cinta de campo, aún cuando el motor de la cinta de transferencia no sea detenido.

Tecla: 

Speed 1. Field
400 mm/s

Speed 1 field (Velocidad campo 1):

Si está ajustado en 0 (valor por defecto), el parámetro no tiene influencia sobre la optimización.

Tecla: 

Tension
0 mm

Tension (Tensión)

Indica la longitud que recorre después de haber hecho la medición inicial de ribbon.

Modo: Shift

X-Shift	Y-Shift
10 mm	13 mm

X-Shift / Y-Shift (Offset eje X / Offset eje Y):

X-Shift (Offset eje X): Indicación del desplazamiento del formato de impresión en dirección X.

Y-Shift (Offset eje Y): Indicación del desplazamiento en la dirección de impresión.

Tecla: 

Lanes	R-Shift
3	-5 mm

Lanes / R-Shift (Ciclos / R-Offset):

Lanes (Ciclos): Indicación de la cantidad de ciclos impresos uno al lado del otro.

R-Shift (R-Offset): Indicación de la distancia durante el cambio a un nuevo ciclo.

Tecla: 

ExpertParameters

Expert parameters (Parámetros del experto):**El menú está protegido por contraseña**

El punto de menú está protegido por contraseña. Introducir la contraseña, pulsar la tecla  para confirmar la introducción y se visualizarán los siguientes parámetros:

Los parámetros se describen en modo 'Standard'.

Modo: SaveStrt

ExpertParameters

Expert parameters (Parámetros del experto):**El menú está protegido por contraseña**

El punto de menú está protegido por contraseña. Introducir la contraseña, pulsar la tecla  para confirmar la introducción y se visualizarán los siguientes parámetros:

Los parámetros se describen en modo 'Standard'.

Ahorro cinta (modo intermitente)

Secuencia de teclas: **F**, , , 

Menú funciones
Ahorro cinta

Tecla: 

Mode
Standard

Mode (Modo):

Selección del tipo de ahorro cinta.

Off: Ahorro de cinta desconectada.

Standard (Estándar): Máxima capacidad de ahorro de cinta. Es decir, con este ajuste no se produce una pérdida de la cinta de transferencia (a excepción de una distancia de seguridad de 1 mm, a fin de que los errores de impresión no se impriman entremezclados).

Shift (Desplazado): Los datos de los diseños se pueden desplazar lateralmente varias veces. De esta forma se puede alcanzar un aprovechamiento máximo de la cinta de transferencia.

Modo: Standard

R-Correction
-1 mm

Transfer ribbon correction (Corrección de ribbon).

0 mm = Se retrocede siempre hasta alcanzar un ahorro cinta (no hay pérdida de cinta de transferencia)

Valor por defecto: + 1 mm

-xx mm = El retroceso puede reducirse.

+xx mm = El retroceso puede ampliarse.

Tecla: 

ExpertParameters

Expert parameters (Parámetros del experto):

El menú está protegido por contraseña

El punto de menú está protegido por contraseña. Introducir la contraseña, pulsar la tecla  para confirmar la introducción y se visualizarán los siguientes parámetros:

Tecla: 

PhDownT PhUpT
35 ms 0 ms

PhDownT = Printhead down time (Bajada del cabezal) in ms:

Es empleado por el algoritmo de ahorro cinta para calcular el inicio del movimiento descendente del cabezal de impresión.

PhUpT = Printhead up time (Tiempo de cabezal elevado) in ms:

Es empleado por el algoritmo de ahorro cinta para calcular si se puede hacer un ahorro cinta de campo o no.

Tecla: 

PhVReactT
10 ms

PhVReactT = Valve reaction time (Tiempo de reacción de la válvula) in ms:

Se calcula cuándo iniciar el movimiento descendente del cabezal.

Tecla: 

Tension RM
0 mm 0

Tension (Tensión):

Indica la longitud que recorre después de haber hecho la medición inicial de ribbon.

Ribbon Mode (Modo ahorro cinta):

0: La cinta de transferencia se retira a todo lo largo de la impresora luego de cada impresión, es decir, no tiene lugar un ahorro cinta entre cada diagrama.

1: La cinta de transferencia se retira solamente del área impresa, es decir, se optimizan los huecos entre los diagramas.

Al cambiar de diagrama, la cinta de transferencia es posicionada automáticamente.

Modo: Shift

X-Shift Y-Shift
10 mm 13 mm

X-Shift / Y-Shift (Offset eje X / Offset eje Y)

X-Shift (Offset eje X): Indicación del desplazamiento del formato de impresión en dirección X.

Y-Shift (Offset eje Y): Indicación del desplazamiento en la dirección de impresión.

Tecla: 

Lanes R-Shift
3 -5 mm

Lanes / R-Shift (Ciclos / R-Offset):

Lanes (Ciclos): Indicación de la cantidad de ciclos impresos uno al lado del otro.

R-Shift (R-Offset): Indicación de la distancia durante el cambio a un nuevo ciclo.

Tecla: 

ExpertParameters

Expert parameters (Parámetros del experto):

El menú está protegido por contraseña

Introducir la contraseña, pulsar la tecla  para confirmar la introducción y se visualizarán los siguientes parámetros:

Los parámetros se describen en modo 'Standard'.

Device Settings (Parámetros del aparato)

Secuencia de teclas: **F**, , , , 

Menú funciones
Parám. aparato

Tecla: 

Administr. campo
OFF

Field handling (Administración de campos):

Off: La memoria del módulo se anula por completo.

Keep graphic (Grabar gráfico): Un gráfico o una fuente True Type se enviarán respectivamente sólo una vez al módulo de impresión, y quedarán almacenados en la memoria interna del módulo de impresión. En las siguientes órdenes de impresión sólo se transmitirán los datos modificados a el módulo. La ventaja aquí es el ahorro de tiempo en la transmisión de los gráficos. Los datos gráficos generados por el propio módulo (escritos internos, códigos de barra...) sólo se generan si son modificados. Aquí se ahorra tiempo de generación.

Delete graphic (Borrar gráfico): Los gráficos o fuentes True Type grabados en la memoria interna del módulo se borrarán, pero el resto de los campos no.

Tecla: 

Codepage
ANSI caracteres

Codepage (Codepage):

Elección del juego de caracteres a utilizar.

Tecla: 

Parámetros ext.
ON

External parameters (Parámetros externos):

Layout dimension only (Sólo dimensión del diseño): Los parámetros de la longitud del diseño, longitud de espacio entre diseños y ancho de diseño se pueden transferir al sistema de impresión. Todos los demás ajustes se pueden hacer directamente en el sistema de impresión.

On: Existe la posibilidad, de introducir mediante nuestro software de gestión de diseños parámetros tales como la impresión y el contraste en el módulo. En este caso, los parámetros insertados directamente en el módulo no se tienen en cuenta.

Off: Sólo se tendrán en cuenta los parámetros introducidos directamente en el módulo.

Tecla: 

Zumbador
On

Buzzer (Zumbador):

Al pulsar cualquier tecla se produce una señal acústica. Rango de valores: 1 ... 7.
Desconectado: Sin señal acústica.

Tecla: 

Idioma
Español

Lanaguage (Idioma):

Selección del idioma en el que se mostrará el texto de la pantalla. Por el momento, tiene la posibilidad de seleccionar alemán, inglés, francés, español, portugués, holandés, italiano, danés, finés, polaco, checo e ruso.

Tecla: 

Entrada person.
On

Customized entry (Personalizar):

On: Al iniciar la impresión aparece en la pantalla una vez una pregunta acerca de variables personalizadas.

Auto: La pregunta sobre variables personalizadas aparece tras cada diseño.

Off: En la pantalla no aparece ninguna pregunta acerca de variables personalizadas. En este caso se imprimirá teniendo en cuenta los valores predeterminados por defecto.

Tecla: 

Hotstart
Off

Hotstart (Hotstart):

On: Es posible reanudar un trabajo de impresión interrumpido, al conectar de nuevo el módulo de impresión.

Off: Tras desconectar el módulo, se borran todos los datos.

Tecla: 

Prot. contraseña
Off

Password (Contraseña):

Con una contraseña se pueden bloquear diversas funciones para el usuario. Existen diversas aplicaciones para las que resulta útil insertar una protección de contraseña.

Tecla: 

Confirm. diseño
On

Layout confirmation (Confirmar cambios en el diseño):

On: Una nueva orden de impresión se imprime recién después de la confirmación en el aparato.

Una orden de impresión continua ya activa se continúa imprimiendo hasta que se efectúa la confirmación en el aparato.

Off: No aparece consulta alguna en la pantalla del direccionamiento.

Tecla: 

Diseño estándar
Off

Standard layout (Diseño estándar):

On: Si se comienza una orden de impresión sin haberla definido previamente, se imprime por defecto el diseño estándar.

Off: Si se comienza una orden de impresión sin haberla definido previamente, aparece un mensaje de error.

I/O Parameters (Parámetros I/O)Secuencia de teclas: **F**, , , , , 

Menú funciones
I/O Parámetros

Tecla: 

IN Nivel señal
1s2x3+4x5x6x7x8x

IN signal level (Nivel de señal IN):

Indicación del señal con la que se iniciará el trabajo de impresión.

+ = el nivel activo de la señal es 'high' (1)

- = el nivel activo de la señal es 'low' (0)

x = el nivel de señal no activado

s = el estado puede verse afectado por el puerto (en combinación con Netstar PLUS)

Tecla: 

OUT Nivel señal
1+2+3+4+5+6+7+8+

OUT signal level (Nivel de señal OUT):

Indicación del nivel de señal para la edición de la señal.

+ = el nivel de señal activo es 'high' (1)

- = el nivel de señal activo es 'low' (0)

s = el estado puede verse afectado por el puerto (en combinación con Netstar PLUS)

Tecla: 

Debouncing (ms)
50

Debouncing (Eliminación de rebotes):

Indicación del tiempo de eliminación de rebotes (debouncing) de la entrada del dispensador en un entorno.

Valores posibles: 0 hasta 100 ms.

Tecla: 

RetrasoInicio (s)
0.00

Start signal delay (Retraso en la señal de inicio):

Indicación del tiempo en segundos para retrasar el inicio de la impresión.

Valores posibles: 0.00 hasta 9.99.

Tecla:  11

ErrorIfNotReady
On

Not ready: error (No dispuesto: error):

On: En caso de que una orden de impresión esté activa pero el módulo de impresión no esté listo para procesarla (p. ej. porque está ya en modo 'imprimiendo'), se emite un mensaje de error.

Off: No se emite ningún mensaje de error.

Tecla: 

Preparada imprim
Off

Ready while printing (Preparada mientras imprime):

Indica si la señal de salida "impresora preparada" (Salida 5, Salida II) permanece active mientras se imprime.

Off: Al principio de la impresión, la señal "impresora preparada" esta inactiva (por defecto).

On: Al principio de la impresión, la señal "impresora preparada" está activa.

Network (Red)Secuencia de teclas: **F**, , , , , 

Menú funciones
Red

Encontrará más información acerca de esta menú en un manual independiente.

Remote Console (Consola remota)Secuencia de teclas: **F**, , , , , 

Menú funciones
Consola remota

Para mayor información acerca de este punto del menú, contacte por favor con nuestro departamento de ventas.

Interface (Puertos)

Secuencia de teclas: **F**        

Menú funciones
Puertos

Tecla:

COM1	Baud	P	D	S
0	9600	N	8	2

M = Modo:

0 - Puerto serial desconectado (Off)
1 - Puerto serial conectado (On)
2 - Puerto serial conectado (On); no se origina ningún aviso en caso de un error de transmisión.

Baud (Baudios): Indicación del número de Bits que se transmitirán por segundo. Pueden elegirse los siguientes valores: 1200, 2400, 4800, 9600, 19200, 38400, 57600 y 115200.

P = Parity (Paridad):

N - Ninguna
E - Par
O - Impar
Debe prestar atención a que los ajustes sean acordes con los efectuados en el módulo.

D = Data bits (Bits de datos):

Configuración de los bits de datos. Puede elegir entre 7 u 8 Bits.

S = Stop bits (Bits de paro):

Puede elegir 1 ó 2 bits de paro.
Indicación de los bits de paro entre los Bytes.

Tecla: 

Inicio (SOH): 01
Parada (ETB): 17

Start/stop sign (Señal Inicio/Parada):

SOH: Inicio del bloque de transmisión de datos → HEX formato 01
ETB: Final del bloque de transmisión de datos → HEX formato 17

Tecla: 

Memoria de datos
Extendida

Data memory (Memoria de datos):



Standard (Estándar): Tras el inicio de un trabajo de impresión se archivarán datos en el buffer de la impresora hasta que éste se llene.
Extended (Extendida): Durante la ejecución de una trabajo de impresión, los datos se siguen recibiendo y transformando.
Off: Tras el inicio de un trabajo de impresión, la impresora no recibirá más datos.

Tecla: 

Test puertos
Off

Port test (Test de puertos):

Compruebe si se transfieren datos a través del puerto.

Pulse las teclas  y  para seleccionar General (On). Pulse la tecla y se imprimirán los datos que se envíen a través del puerto que se desee (COM1, LPT, USB, TCP/IP).

Emulation (Emulación)

Secuencia de teclas: **F**        



Menú funciones
Emulación

Tecla:

Protocolo
ZPL

Protocol (Protocolo):

CVPL: Carl Valentin Programming Language
ZPL: Zebra® Programming Language

Con las teclas  y  se puede seleccionar el protocolo. Pulse la tecla para confirmar la selección. El módulo realiza un arranque nuevo y las instrucciones ZPL II® son transformadas internamente por el módulo en instrucciones CVPL, y ejecutadas posteriormente por el módulo.

Tecla: 

Resolución cabez
11.8 (Dot/mm)

Printhead resolution (Resolución de cabezal de impresión):

En caso de emulación ZPL II® activa hay que ajustar la resolución del cabezal de impresión del módulo emulada.

Tecla: 

Asignación plat.
B: ->A: R: ->R:

Drive mapping (Asignación platina):

El acceso a las unidades de disco Zebra® es desviado hacia la unidad de disco Valentin correspondiente.

Date & Time (Fecha & Hora)





Secuencia de teclas: **F**, , , , , , , , , , 

Menú funciones
Fecha/hora

Tecla: 

Fecha 17.11.04
Hora 13:28:06

Set date/time (Modificar fecha y hora):

La fila superior de la pantalla muestra la fecha actual, la fila inferior la hora actual. Con ayuda de las teclas  y  se puede acceder al campo siguiente en cada caso, para modificar los valores mostrados con las teclas  y  al alza o a la baja..

Tecla: 

Horario verano
On

Summertime (Horario de verano):

On: El módulo cambia automáticamente al horario de invierno y de verano.

Off: El horario de verano no se reconoce ni se aplica automáticamente.

Tecla: 

ST Inic. formato
WW/WD/MM

Start of summertime - format (Formato inicio horario de verano):

Selección del formato para insertar la fecha de comienzo del horario de verano.

DD = Día

WW = Semana

WD = Día de la semana

MM = Mes

YY = Año,

next day = se contará a partir del día siguiente

Tecla: 

WW WD MM
Últimodomingo 03

Start of summertime - date (Fecha inicio del horario de verano):

Inserción de la fecha de comienzo del horario de verano. Esta inserción se refiere al formato anteriormente seleccionado. En el ejemplo más arriba se cambiará al horario de verano automáticamente el último domingo de marzo (03).

Tecla: 

ST Inic. horario
02:00

Start of summertime - time (Hora inicio del horario de verano):

Con ayuda de esta función puede usted insertar la hora en la que debe comenzar el horario de verano.

Tecla: 

ST Fin formato
WW/WD/MM

Endo of summertime - format (Formato de fin del horario de verano):

Selección del formato para determinar el final del horario de verano.

Tecla: 

WW WD MM
Últimodomingo 10

End of summertime - date (Fecha del fin del horario de verano):

Inserción de la fecha en la que debe finalizar el horario de verano. La inserción se refiere al formato anteriormente seleccionado. En el ejemplo de más arriba se cambiará al horario de verano automáticamente el último domingo de octubre (10).

Tecla: 

ST Fin horario
03:00

End of summertime - time (Hora fin del horario de verano):

Inserción de la hora en la que debe terminar el horario de verano.

Tecla: 

Dif. horaria
01:00

Time shifting (Diferencia horaria):

Indica la diferencia horaria establecida entre el horario de verano y de invierno en horas y minutos.

Service Functions (Funciones de asistencia técnica)



¡NOTA!

Al objeto de que el distribuidor o en su caso el fabricante del módulo puedan prestarle el servicio de asistencia técnica con rapidez, los parámetros seleccionados, puede leerse directamente en el aparato.

Secuencia de teclas: **F**, , , , , , , , , , , 

Menú funciones
Asisten. técnica

Tecla: 

H P R1 R2 C ENC
0 1 1 0 0 0

Photocell parameters (Parámetros fotocélula):

H = Carcasa (disponible sólo si hay un interruptor de la tapa)

0 - abierta

1 - cerrada

P = Presión:

Indica el valor entre 0 y 1 del control de la presión del aire.

R1 = Rollo bobinador de la cinta de transferencia

Indicación del valor de 0 a 2 del estado del rollo de bobinado.

4 estados son indicados (ninguna marcación en la fotocélula, marcación de la derecha, marcación de la izquierda, marcación completo en la fotocélula).

R2 = Rollo desbobinador de la cinta de transferencia:

Indicación del valor de 0 a 2 del estado del rollo de desbobinado.

4 estados son indicados (ninguna marcación en la fotocélula, marcación de la derecha, marcación de la izquierda, marcación completo en la fotocélula).

C = Carriage:

Posición del carril de impresión.

ENC = Encoder:

Muestra el estado actual del encoder.

Tecla: 

Contador (m)
D5000007 G000017

Paper counter (Contador de recorrido):

D: Muestra el recorrido en metros efectuado hasta ahora por el cabezal de impresión.

G: Muestra el recorrido en metros realizado por el aparato.

Tecla: 

Resistencia Dot
1250

Heater resistance (Resistencia calentadora):

Para obtener una impresión de calidad, al cambiar el cabezal de impresión debe instalarse el valor en ohmios indicado.

Tecla: 

Temp. cabezal
23

Printhead temperature (Temperatura del cabezal de impresión):

Muestra la temperatura del cabezal de impresión.

Tecla: 

Ribbon Ink Side
600 m Out

Ribbon (Longitud cinta de transferencia):

Selección de la longitud de la cinta de transferencia empleada (300 m, 450 m, 600 m, 900 m, 1000 m).

Ink side (Bobinado):

Selección con respecto a si se emplean cintas de transferencia con bobinado interior o exterior. Por defecto: Bobinado exterior

Tecla: 

BrkPow BrkPowP
100 % 100 %

Brake power (Potencia de frenado):

BrkPow: Ajuste de la potencia de frenado por el acelerón y el frenazo en %.

BrkPowP: Ajuste de la potencia de frenado durante la impresión en %.

Tecla: 

Ej. impresión
Informe estatus

Print examples (Ejemplos de impresión):

Se imprimen todos los ajustes de la impresora.

Settings (Informe de estatus): Imprime todos los parámetros del módulo, como p.ej. velocidad, diseños, cinta de transferencia, etc.

Bar codes (Códigos de barra): Se imprimen todos los códigos de barra disponibles en el módulo de impresión.

Fonts (Fuentes): Imprime todas las fuentes vectoriales y bitmap.

Tecla: 

Input: 11111111
Output: 00000000

Input/Output (Entrada/Salida):

Muestra el nivel de señal que indica con qué señal se iniciará la orden de impresión.

0 – Bajo

1 – Alto

Tecla: 

Diagnostic
Enter

Diagnostic (Diagnóstico):

Pulse la tecla  para acceder al menú Diagnóstico.

Tecla: 

EncProf	NoOfProf
Off	10

Encoder Profiling (Perfil codificación):

Los valores de transmisor de giro con inicio de impresión en archivos de acceso se guardan en la tarjeta CF. En base a estos datos puede realizarse una imagen gráfica de la curva del transmisor de giro.

Tecla: 

DiaRU	DiaRW
68mm	655mm

Roller diameter (Diámetro del rollo de la cinta de transferencia):

DiaRW = Diámetro del rollo de bobinado de la cinta de transferencia.

DiaRU = Diámetro del rollo de desbobinado de la cinta de transferencia.

Tecla: 

Enc. Average
100

Encoder average (Media del encoder):

Cantidad de los valores a través de los cuales se transmiten las señales del codificador.

Tecla: 

IgnrStrt	IntPrts
123	456

Diagnostic - Counter (Diagnóstico - Contador):

Se cuentan los acontecimientos relevantes y se registran en la memoria RAM. El registro se pierde después de desconectar el aparato.

IgnrStrt = Contador para señales de inicio ignoradas.

IntPrts = Contador para órdenes de impresión canceladas.

Tecla: 

Njb	Nrd	Prt
+000	+999	+999

NJb = No job (sin trabajo):

Contador para señales de inicio ignoradas porque la orden de impresión no estaba activa.

NRd = Not ready (no está listo):

Contador para señales de inicio ignoradas porque la orden de impresión no estaba listo (detenido o mensaje de error).

Prt = Printing (impresión):

Contador para señales de inicio ignoradas, durante bien el aparato imprime/está activo.

Tecla: 

MS/I	ItfI	SpdS
+000	+999	+999

MS/I = Manual stopped/interrupted (interrupción/parada manual):

Se pulsó la tecla de parada en la laminilla de teclado, en el panel o en un programa.

ItfI = Interface interrupted (interrupción desde el puerto):

La orden de impresión se canceló porque se recibieron nuevos datos a través de una interfaz.

SpdS = Speed stopped (parada por velocidad):

La orden de impresión se canceló porque la velocidad de impresión medida era demasiado lenta.

Tecla: 

On/Offline
Off

Online/Offline (Online/Offline):

Esta función se activa, por ejemplo, cuando hay que cambiar la cinta de impresión. Se impide el procesamiento de una orden de impresión, no obstante no estar aún listo el aparato. Si la función está activada, puede cambiarse entre el modo online y offline con la tecla . En la pantalla se visualiza el estado respectivo (Standard: Apagada).

Online (Online): Pueden recibirse datos a través de interfaces. Las teclas de la laminilla de teclado están activadas únicamente cuando se cambió al modo offline con la tecla .

Offline (Offline): Las teclas de la laminilla de teclado están nuevamente activadas, pero los datos recibidos ya no se procesan. Cuando el aparato está nuevamente en el modo online, también se reciben otra vez nuevas órdenes de impresión.

Tecla: 

Aviso próximo
On ⌀: 40 v: 100

Transfer ribbon prior warning (Aviso próximo fin de cinta):

Al seleccionar esta función, aparecerá una señal de aviso vía control output, antes de que la cinta de transferencia llegue a su fin.

Warning diameter (Aviso próximo de diámetro fin de cinta):

Ajuste del preaviso de diámetro (mandril) de la cinta de transferencia.

Si en este punto se inserta un valor en mm., al alcanzarse este diámetro (medido en el rollo de la cinta de transferencia), se mostrará una señal a través del control de salida.

v = reduced speed (Velocidad de impresión reducida):

Ajuste de la velocidad de impresión reducida. Ésta puede ajustarse en los límites de la velocidad normal de impresión. Adicionalmente, existen también los ajustes:

-: Sin velocidad de impresión reducida

0: El módulo se detiene con 'fallo de cinta de transferencia' al alcanzar el diámetro de preaviso.

Main Menu (Menú principal)

Tras conectar el módulo aparece el siguiente aviso en la pantalla:



<pre>* DC c107-12K * 14/09/05 10:16</pre>	<p>Primera línea = Menú principal Segunda línea = Fecha y hora actuales</p>
<p>Tecla: <input type="radio"/></p>	
<pre>* DC c107-12K * V1.44</pre>	<p>Segunda línea = Versión del programa (Firmware).</p>
<p>Tecla: <input type="radio"/></p>	
<pre>* DC c107-12K * Build 0201</pre>	<p>Segunda línea = Versión de creación del Software.</p>
<p>Tecla: <input type="radio"/></p>	
<pre>* DC c107-12K * Jun 2 2005</pre>	<p>Segunda línea = Fecha de creación del Firmware.</p>
<p>Tecla: <input type="radio"/></p>	
<pre>* DC c107-12K * 10:37:34</pre>	<p>Segunda línea = Hora de creación de la versión del Firmware.</p>
<p>Tecla: <input type="radio"/></p>	
<pre>* DC c107-12K * B-Font: v5.01</pre>	<p>Segunda línea = Versión fuente de los tipos de letra Bitmap.</p>
<p>Tecla: <input type="radio"/></p>	
<pre>* DC c107-12K * V-Font: V1.01</pre>	<p>Segunda línea = Versión fuente de los tipos de letra vectoriales.</p>
<p>Tecla: <input type="radio"/></p>	
<pre>* DC c107-12K * FPGA V1.4.0 T9</pre>	<p>Segunda línea = Versión del FPGA.</p>
<p>Tecla: <input type="radio"/></p>	
<pre>* DC c107-12K * 16 MB Memory</pre>	<p>Segunda línea = Capacidad de almacenamiento del aparato en MB.</p>
<p>Tecla: <input type="radio"/></p>	
<pre>* DC c107-12K * 8 MB FLASH</pre>	<p>Segunda línea = Tamaño de almacenamiento de la FLASH en MB.</p>
<p>Tecla: <input type="radio"/></p>	
<pre>* DC c107-12K * A0 MO V.1.3.1 AB</pre>	<p>Segunda línea = Versión del primer procesador (activación del motor).</p>
<p>Tecla: <input type="radio"/></p>	
<pre>* DC c107-12K * A1 MO V.1.3.1 AB</pre>	<p>Segunda línea = Versión del segundo procesador (activación del motor).</p>
<p>Tecla: <input type="radio"/></p>	
<pre>* DC c107-12K * A2 IO V.1.3.1 AB</pre>	<p>Segunda línea = Versión del tercer procesador (supervisión E/S).</p>

Compact Flash Card (Tarjeta Compact Flash)

Select layout (Seleccionar diseño)

Secuencia de teclas: 

```
→layout01 0
A:\STANDARD
```

Pulsar las teclas  y  para seleccionar el diseño deseado en el directorio STANDARD.
Pulse la tecla  para seleccionar el diseño.

```
Arranque impr.
Cantidad: 12345
```

Seleccionar la cantidad de diseños que deben imprimirse.
Pulsar la tecla  para iniciar el trabajo de impresión.

Load file (Cargar un fichero)



Secuencia de teclas: , 

```
CF Funciones
Cargar fichero
```

Tecla: 

```
□→ .. <
A:\STANDARD
```

Seleccione el archivo deseado y confirme su selección con .

Pulse la tecla  e introduzca el número de diseños que quiere imprimir. Confirme con la tecla  y comenzará la orden de impresión mediante una señal externa (Entrada 1, PIN 1 y PIN 4).

Save layout (Memorizar un diseño)

Secuencia de teclas: , , 

```
CF Funciones
Memorizar diseño
```

Tecla: 

```
Archivo ya exis.
¿Sobreescribir?
```

Seleccione el directorio y el diseño que desea memorizar, y confirme su elección con la tecla .

Confirme la pregunta con la tecla  y el diseño quedará memorizada.

Save configuration (Memorizar configuración)

Secuencia de teclas: , , , 

```
CF Funciones
Memorizar config
```

De manera estándar se propone el nombre de archivo config.cfg. Éste puede ser modificado por el usuario. En este archivo se guardan los parámetros del módulo que no se almacenan permanentemente en el Flash interno.

Pulse la tecla  para comenzar la memorización.

Change directory (Cambiar directorio)

Secuencia de teclas: , , , , 

```
CF Funciones
Cambiar director
```

Tecla: 

```
←<.> M
A:\STANDARD\
```

En la línea inferior se visualiza el directorio actualmente seleccionado.

Pulse las teclas  y  para cambiar el directorio a la línea superior.

Pulse las teclas  y  para visualizar los posibles directorios.

Pulse la tecla  para incorporar el directorio seleccionado.

Delete file (Borrar archivo)

Secuencia de teclas: , , , , , 

CF Funciones
Borrar archivo

Seleccione el directorio o el diseño que desea borrar y confirme su selección con .



Format CF card (Formatear tarjeta CF)

Secuencia de teclas: , , , , , , 









CF Funciones
Formatear

Taste: 

Formatear A:

Seleccione con la tecla  la unidad a formatear desde la tarjeta Compact Flash y confirme su selección con . Al formatear se crea automáticamente el directorio STANDARD.

Free memory space (Mostrar memoria libre)

Secuencia de teclas: , , , , , , , 

CF Funciones
Memoria libre

Se mostrará la memoria libre todavía disponible en la tarjeta Compact Flash.

Datos técnicos

	Dynacode 53	Dynacode 107	Dynacode 128
Resolución	300 dpi	300 dpi	300 dpi
Velocidad de impresión			
modo continuo	50 ... 800 mm/s	50 ... 600 mm/s	50 ... 450 mm/s
modo intermitente	50 ... 600 mm/s	50 ... 600 mm/s	50 ... 600 mm/s
Velocidad de retorno	sólo modo intermitente máx. 600 mm/s		
Ancho de impresión	53,3 mm	106,6 mm	128 mm
Máx. largo de impresión			
modo continuo	6000 mm	3000 mm	3000 mm
modo intermitente	75 mm	75 mm	75 mm
Anchura paso del bastidor	según deseos de los clientes		
Cabezal de impresión	Corner Type	Corner Type	Corner Type
Emisión sonora (distancia de medición 1 m)			
Nivel medio de potencia sonora	60 dB(A)	65 dB(A)	68 dB(A)
Cinta de transferencia			
Tinta	exterior / interior (opción)	exterior / interior (opción)	exterior / interior (opción)
Máx. diámetro de rollo	98 mm	82 mm	75 mm
Diámetro interior	25,4 mm / 1"	25,4 mm / 1"	25,4 mm / 1"
Máx. largo	900 m	600 m	450 m
Ancho	55 mm	110 mm	130 mm
Medidas (ancho x alto x fondo)			
Mecánica de impresión			
sin bastidor de montaje	204 x 180 x 234 mm	204 x 180 x 290 mm	204 x 180 x 312 mm
con bastidor de montaje	depende de anchura paso del bastidor		
Unidad de control	240 x 125 x 332 mm conjunto de cable conexión a mecánico 2,5 m		
Peso			
Mecánica de impresión	9,5 kg	11 kg	11,7 kg
Unidad de control (incl. cables)	5,5 kg	5,5 kg	5,5 kg
Electrónica			
Procesador	High Speed 32 Bit		
RAM	16 MB / 64 MB (bajo pedido)		
Ranura de expansión	Para tarjeta CF Tipo I		
Caché con batería	Para reloj en tiempo real y guardar datos al apagado		
Señal de aviso	Señal acústica cuando hay un error		
Puertos			
Serie	RS-232C (hasta 115200 Baud)		
Paralelo	Centronics		
Ethernet	10/100 Base T		
USB	1.1		
Toma de corriente			
Conexión aire comprimido	mín. 6 bares seco y libre de aceite		
Tensión nominal	110 ... 230 V / 50 ... 60 Hz		
Corriente nominal	230 V / 1,5 A – 110 V / 3 A		
Valores de seguridad	230 V / 2 AT – 110 V / 4 AT		
Condiciones de funcionamiento			
Temperatura	5 ... 40 °C		
Humedad relativa	máx. 80% (sin condensación)		

Panel de control	
Teclas	Prueba de impresión, Menú de funciones, Cantidad, Tarjeta CF, Avance de etiqueta, Intro, Cursor x 4
LCD display	Display gráfico de 132 x 32 píxeles con retroiluminación
Características	
	Fecha, hora, turnos 11 idiomas (otros bajo pedido) Parámetros de diseño, puertos, contraseña, variables
Monitorización	
La impresión se detiene si:	Final de ribbon / Fin de diseño / Cabezal abierto
Informe de Estado	Amplio informe del estado del módulo con información sobre los parámetros. P.e. largo de impresión, tiempo de impresión, puertos de las fotocélulas y parámetros de red. Impresión de todas las fuentes internas y códigos de barras en memoria.
Escritura	
Tipos de letra	6 Fuentes Bitmap 8 Fuentes Vectoriales/TrueType 6 Fuentes proporcionales. Otras fuentes bajo pedido
Juego de caracteres	Windows 1250 a 1257, DOS 437, 850, 852, 857 Caracteres europeos occidentales y orientales, Latinos, Cirílicos, Griegos y Árabes (opción). Otros caracteres bajo pedido
Tipos de letra bitmap	Tamaño variable en altura y anchura desde 0,8 ... 5,6 Zoom 2 ... 9. Orientación 0°, 90°, 180°, 270°
Tipos de letra vectoriales/TrueType	Tamaño variable en altura y anchura desde 1 ... 99 mm Zoom Variable. Orientación 0°, 90°, 180°, 270°
Atributos de las fuentes	Depende de la fuente del carácter Negrita, Cursiva, Inversa, Vertical
Distancia entre letras	Variable
Códigos de barra	
Códigos de barra 1D	CODABAR, Code 128, Code 2/5 interleaved, Code 39, Code 39 extended, Code 93, EAN 13, EAN 8, EAN ADD ON, GS1-128, Identcode, ITF 14, Leitcode, Pharmacode, PZN 7 Code, PZN 8 Code, UPC-A, UPC-E
Códigos de barra 2D	Aztec Code, CODABLOCK F, DataMatrix, GS1 DataMatrix, MAXICODE, PDF 417, QR Code
Códigos compuestos	GS1 DataBar Expanded, GS1 DataBar Limited, GS1 DataBar Omnidireccional, GS1 DataBar Stacked, GS1 DataBar Stacked Omnidireccional, GS1 DataBar Truncated
	Todos los códigos de barras son variables en altura, anchura y aspecto Orientación 0°, 90°, 180°, 270° Opcionalmente llevan dígito de control y línea de lectura
Software	
Configuración	ConfigTool
Control de procesos	NiceLabel
Software de diseño	Labelstar Office Lite Labelstar Office
Controladores de Windows	Windows XP® 32/64 Bit, Windows Vista® 32/64 Bit Windows 7® 32/64 Bit, Windows 8® 32/64 Bit Windows 8.1® 32/64 Bit, Windows Server 2003® (R2) 32/64 Bit Windows Server 2008® 32/64 Bit, Windows Server 2008® (R2) 64 Bit Windows Server 2012® 64 Bit, Windows Server 2012® (R2) 64 Bit

Modificaciones técnicas reservadas

Mantenimiento y limpieza



¡PELIGRO!

¡Existe riesgo de muerte por electrocución!

⇒ Antes de cualquier trabajo de mantenimiento debe desconectarse el módulo de la corriente.

Limpieza del cabezal de impresión



¡NOTA!

Para limpiar el aparato se recomienda llevar equipo de protección personal, como gafas de protección y guantes.

Durante la impresión se puede ensuciar el cabezal de impresión p.ej. con partículas de color que se insertan en la cinta de transferencia; por ello es conveniente y básicamente necesario limpiar el cabezal a intervalos regulares de tiempo, dependiendo de las horas de funcionamiento del aparato y de la influencia del entorno, como por ejemplo, polvo u otros.



¡ATENCIÓN!

¡Daño de el módulo de impresión directa!

⇒ No utilizar objetos afilados o duros para limpiar el cabezal de impresión.

⇒ No tocar la lámina protectora del cabezal de impresión.

- Saque el casete del natro di transferencia.
- Limpie la superficie del cabezal de impresión con un bastón especial de limpieza o con un bastoncillo de algodón empapado en alcohol puro.
- Antes de poner en funcionamiento el módulo, dejar secar el cabezal de impresión durante 2 o 3 minutos.



¡NOTA!

Deben seguirse las instrucciones de manipulación para la utilización de alcohol isopropílico (IPA). En caso de contacto con la piel o los ojos, enjuagar bien con agua corriente. Si persiste la irritación, acuda a un médico. Asegúrese de que el lugar esté bien ventilado.

Cambio del cabezal de impresión



¡ATENCIÓN!

¡El cabezal de impresión debe estar protegido frente a posibles daños por cargas electrostáticas!

⇒ Colocar el módulo sobre una superficie conductora con toma de tierra.

⇒ El operario debe conectarse a una toma de tierra de una manera adecuada (p.ej. mediante una conexión de muñequera).

⇒ No deben tocarse con las manos los contactos de conexiones a enchufes.

⇒ El cristal de protección del cabezal de impresión no se debe arañar ni rasguñar.

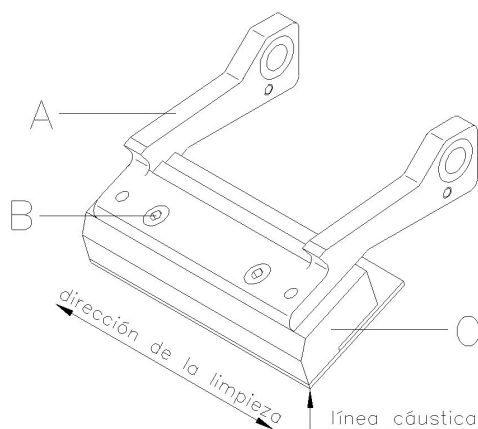

Desmontaje del cabezal de impresión

- Saque el casete del cinta di transferencia.
- Desplace el cabezal de impresión a la adecuada posición de servicio técnico.
- Presione ligeramente hacia abajo el soporte del cabezal (A), hasta que pueda introducirse una llave macho hexagonal (SW 2,5) en los tornillos (B).
- Retire los tornillos (B) y el cabezal de impresión (C).
- Afloje ambas uniones enchufables del cabezal.

Montaje del cabezal de impresión

- Conecte las uniones enchufables.
- Posicione el cabezal de impresión en el soporte (A), de tal modo que los arrastradores encajen en los correspondientes taladros del soporte del cabezal de impresión (A).
- Sosteniendo el soporte con un dedo, ligeramente sobre el cilindro impresor, verificar la posición correcta del cabezal de impresión (A).
- Coloque el tornillo (B) y apretar con la llave hexagonal.
- Coloque de nuevo el casete del cinta de transferencia.
- Introduzca el valor de resistencia del nuevo cabezal de impresión en el menú funciones, punto 'Asistencia técnica' y el submenú 'Resistencia-dot'. Encontrará el valor en la placa identificativa del cabezal de impresión.
- Controle la posición del cabezal de impresión mediante la generación de un test de impresión.

Ajuste del ángulo (modo intermitente)

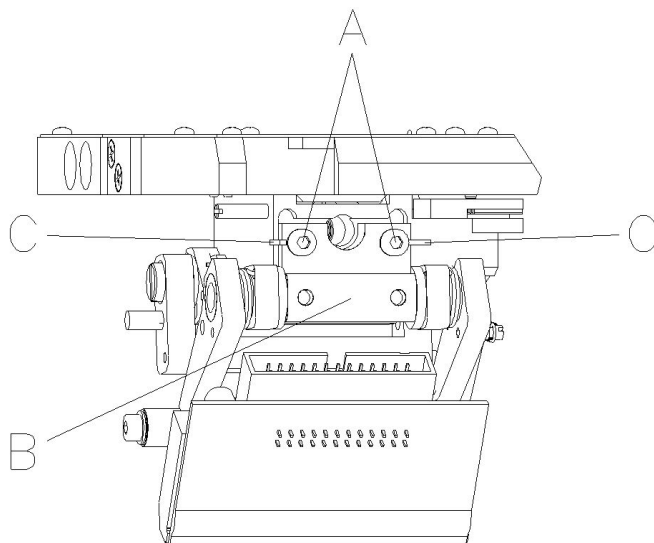

El montaje del ángulo del cabezal de impresión se efectúa por defecto con un ángulo de 26° de la superficie de impresión. Sin embargo, las tolerancias de fabricación del cabezal de impresión y de la mecánica pueden hacer necesario otro ángulo.



¡ATENCIÓN!

¡Deterioro del cabezal de impresión debido a un desgaste desparejo!

Mayor desgaste de la cinta de transferencia al tirar muy rápido.

⇒ Modificar los ajustes de fábrica únicamente en casos excepcionales.

- Afloje los dos tornillos de allen internos (A).
- Desplace la pieza de ajuste (B) para regular el ángulo entre el cabezal y el soporte.
Desplace hacia abajo = reducir el ángulo
Desplace hacia arriba = aumentar el ángulo
- Apriete los tornillos de allen internos (A).
- Inicie un trabajo de impresión de aprox. 2 ó 3 diseños y controle si la cinta de transferencia discurre de forma correcta y sin arrugas.



¡NOTA!

Las ranuras (C) sirven para verificar la posición. Procurar que el ajuste sea lo más paralelo posible.

Guide de référence rapide et de
sécurité des produits

Français

Copyright by Carl Valentin GmbH.

Les indications concernant le volume de livraison, l'apparence, la performance, les dimensions et le poids correspondent à nos connaissances au moment de la création de ce document.

Toutes modifications réservées.

Tous droits réservés, y compris ceux des traductions.

La reproduction, ou la transformation de ce manuel, partielle ou intégrale, sous quelque forme que ce soit (impression, photocopie ou tout autre procédé) est interdite sauf autorisation écrite de Carl Valentin GmbH.

Par l'évolution permanente, des différences peuvent survenir entre la documentation et le matériel. Consulter le site internet www.carl-valentin.de pour obtenir la dernière version.

Marques

Toutes les marques ou tous les noms commerciaux sont des marques déposées ou des noms commerciaux déposés par leur propriétaire respectif, même s'ils ne sont pas expressément indiqués comme tels. En l'absence de cette mention, ils ne doivent toutefois pas être considérés comme une marque non déposée ou un nom commercial non déposé.

Les blocs d'impression directe Carl Valentin répondent aux directives de sécurité suivantes:

- CE** Directive CE relative aux machines (98/37/CE)
- Directives CE sur les appareils à basse tension (2006/95/CE)
- Directive relative à la compatibilité électromagnétique (89/336/CEE)



Carl Valentin GmbH

Postfach 3744
78026 Villingen-Schwenningen
Neckarstraße 78 – 86 u. 94
78056 Villingen-Schwenningen

Phone +49 (0)7720 9712-0
Fax +49 (0)7720 9712-9901

E-Mail info@carl-valentin.de
Internet www.carl-valentin.de

Contenu

Usage conforme	64
Consignes de sécurité	64
Dépollution conforme à l'environnement	65
Conditions d'opération	66
Déballer le bloc d'impression directe	69
Contenu de la livraison	69
Connexion à l'alimentation	69
Préparations pour la mise en route	69
Contrôle d'impression	69
Mettre en service le bloc d'impression direct	69
Insertion de la cassette de film transfert	70
Print Settings (Initialisation)	71
Machine Parameters (Paramètres de machine)	71
Layout Parameters (Layout)	72
Ribbon Save (Optimisation) - Mode continu	73
Ribbon Save (Optimisation) - Mode intermittent	75
Device Settings (Paramètres d'appareil)	76
I/O Parameters (I/O Paramètres)	77
Network (Réseau)	77
Remote Console (Remote console)	77
Interface (Interface)	78
Emulation (Emulation)	78
Date & Time (Date & Heure)	79
Service Functions (Fonctions service)	80
Main Menu (Menu principal)	82
Carte Compact Flash	83
Données techniques	85
Nettoyer la tête d'impression	87
Echanger la tête d'impression	87
Ajustement d'angle (mode intermittent)	88

Usage conforme

- Le bloc d'impression directe répond à un niveau technique de pointe qui est conforme aux règles reconnues en matière de sécurité et des règlements. Malgré cela, un danger pour la vie et l'intégrité physique de l'utilisateur ou des tiers pourraient se poser et le bloc d'impression directe ou d'autres biens pourraient être endommagés pendant le fonctionnement du dispositif.
- Le bloc d'impression directes doit être utilisée uniquement dans des conditions techniques conformes aux prescriptions, prescriptions, conscient de la sécurité et des dangers et en respectant le mode d'emploi. Certains dérangements, qui nuisent à la sécurité, doivent être éliminés immédiatement.
- Le bloc d'impression directe est destiné exclusivement à imprimer des matériaux appropriés et autorisés par le fabricant. Une utilisation d'un autre type ou dépassant ce cadre n'est pas conforme aux prescriptions. Le fabricant/fournisseur ne répond pas des dommages résultant d'un usage inapproprié; seul l'utilisateur en porte le risque.
- Le respect du mode d'emploi fait partie également d'une utilisation conforme, y compris les recommandations / les prescriptions de maintenance données par le fabricant.

Consignes de sécurité

- Le bloc d'impression directe est conçu pour les réseaux électriques avec une tension alternative de 230V. Brancher le bloc d'impression directe uniquement à des prises électriques avec prise de terre.



REMARQUE!

Lors des modifications de la tension secteur, il faut adapter la valeur du fusible (voir des 'données techniques').

- Raccorder le bloc d'impression directe uniquement avec des appareils qui induisent de la très basse tension de protection.
- Avant de faire ou de défaire les connexions, éteignez tous les appareils connectés (ordinateur, imprimante, accessoires, etc.).
- Utiliser le bloc d'impression directe uniquement dans un environnement sec et ne pas le mouiller (projection d'eau, brouillard, etc.).
- Le bloc d'impression directe ne peut pas actionner dans l'atmosphère explosive et à proximité des lignes à haute tension.
- N'installer le bloc d'impression directe que dans les environnements protégé contre des poussières d'aiguisage, limaille de fer et des corps étrangers similaires.
- Si le bloc d'impression directe est utilisé avec le capot ouvert, veiller à ce que les vêtements, les cheveux, les bijoux ou autres des utilisateurs n'entrent pas en contact avec les éléments en rotation.



REMARQUE!

Les exigences de la norme EN60950-1 concernant le carter de protection anti-incendie ne sont pas remplies sur l'unité d'impression ouverte, conditionné par la construction. Ceux-ci doivent être garantis par l'installation dans la machine finale.

- Les composants de la tête d'impression peuvent devenir très chauds pendant l'impression. Ne pas toucher ces pièces pendant l'utilisation. Laisser refroidir les composants avant toutes interventions de maintenance ou de réglage.
- Exécuter uniquement les actions décrites dans ce mode d'emploi. Les travaux dépassant ce cadre doivent être effectués uniquement par le fabricant ou en accord avec le fabricant.
- Des interventions inadéquates sur les parties électroniques ou leurs logiciels peuvent causer des dysfonctionnements.
- D'autres interventions inappropriées ou transformations de l'appareil peuvent avoir une incidence sur sa sécurité.
- Les réparations doivent toujours être effectuées dans un atelier qualifié possédant les compétences et le matériel nécessaires pour une remise en état optimale.
- Des autocollants sont disposés sur le matériel afin de mettre en garde l'utilisateur sur les dangers auxquels il pourrait être exposé. Ne pas retirer ces autocollants afin d'être constamment informé de la présence de ces risques.
- Lors de l'installation dans la machine complète, le module d'impression directe doit être intégré au circuit d'arrêt d'urgence.
- Tous les dispositifs de protection par isolation doivent être en place avant la mise en marche de la machine.



DANGER!

Danger de mort par tension électrique!

⇒ Ne pas ouvrir le capot de protection.

Dépollution conforme à l'environnement

Des fabricants des appareils B2B sont obligés à partir du 23 mars 2006 à reprendre et recycler des appareils anciens qui ont été fabriqués après le 13 août 2005. Ces appareils anciens ne peuvent pas principalement être transmis à des points de ramassage communaux. Ils ne peuvent être recyclés organisés et éliminés les déchets que par le fabricant. En conséquence des produits Valentin conformément marqués peuvent être retournés à l'avenir à Carl Valentin GmbH.

Les appareils anciens sont éliminés les déchets de façon appropriée.

Carl Valentin GmbH perçoit à temps toutes les obligations dans le cadre de l'enlèvement des déchets d'appareils anciens et permet ainsi aussi la vente des produits sans difficultés. Veuillez faire attention que nous ne pouvons reprendre des appareils envoyés que franco de port.

Pour plusieurs informations, voyez la directive DEEE ou notre page web www.carl-valentin.de.

Conditions d'opération

Avant la mise en route et pendant l'utilisation de nos systèmes, observer les conditions d'utilisation pour assurer une fonction sans perturbation.

Lire soigneusement ces conditions d'utilisation.

En cas de questions au sujet de l'utilisation pratique de ces conditions veuillez contacter votre distributeur.

Conditions générales

Transporter et stocker nos systèmes exclusivement dans leur emballage d'origine.

L'installation et la mise en service du bloc d'impression directe n'est autorisée que si les conditions d'exploitation ont été remplies.

La mise en service est interdite tant qu'il n'a pas été déterminé que la machine, si concernée, dans laquelle la machine incomplète doit être installée, est conforme aux dispositions de la Directive Machines 2006/42/CE.

Avant la mise en service, la programmation, l'utilisation, le nettoyage et l'entretien de nos blocs d'impression directe, lire attentivement ces instructions.

Seuls les opérateurs expérimentés sont autorisés à manier nos blocs d'impression directe.



REMARQUE!

Effectuer régulièrement des formations.

Le contenu des formations comprend les chapitres 'Conditions d'opération', 'Insérer le matériau' et 'Maintenance et nettoyage'.

Ces instructions sont également valables pour les appareils livrés et non produits par notre société.

N'utiliser que des pièces de recharge d'origine.

Pour les pièces détachées/d'usure, veuillez vous adresser au fabricant.

Indications sur la batterie lithium

La carte CPU du bloc d'impression directe est équipée d'une batterie au lithium (type CR 2032) pour lequel le règlement de la batterie est à appliquer. Ce règlement prévoit que les batteries déchargées doivent être déposées dans les conteneurs publics dédiés à la collecte des batteries et piles usagées. Dans le cas où les batteries ne sont pas déchargées complètement, on doit prendre des mesures pour faire un court-circuit. Lors d'une mise hors service du bloc d'impression directe, la batterie doit être éliminée séparément du bloc d'impression directe.



DANGER!

Danger de mort par explosion!

⇒ Utiliser d'outil non-conducteur.

Conditions pour le lieu d'installation

Le lieu d'installation doit être plat, exempt de vibrations et de courants d'air.

Installer les blocs d'impression directe de manière à pouvoir effectuer l'entretien sans trop de difficultés.

Installation de l'alimentation

L'installation de l'alimentation de nos blocs d'impression directe doit être effectuée selon les règles internationales, surtout selon les recommandations d'une des trois commissions suivantes:

- International Electronic Commission (IEC)
- Comité Européen pour Normes Electroniques (CENELEC)
- Verband Deutscher Elektrotechniker (VDE)

Nos systèmes d'impression directe sont construits selon les règles VDE et ne fonctionnent qu'avec prise de terre. L'alimentation doit être équipée d'une prise de terre pour éliminer le parasitage interne.

Indications techniques de l'alimentation

Tension et fréquence d'alimentation	Voir plaque signalétique
Tolérance admissible de la tension d'alimentation:	+6% jusqu'à -10% de la valeur nominale
Tolérance admissible de la fréquence d'alimentation:	+2% jusqu'à -2% de la valeur nominale
Facteur distorsion admissible de la tension d'alimentation:	<=5%

Mesures antiparasites:

Dans le cas où votre réseau est infecté (p.ex. en utilisant des machines contrôles thyristor) il faut prendre des mesures antiparasites, par exemple:

- Prévoir une alimentation séparée pour nos blocs d'impression directe.
- En cas de problème installer un transformateur d'isolement ou un filtre antiparasite en avant de l'alimentation électrique de nos appareils.

Perturbation atmosphérique et immunité

Emission de perturbation conformément à EN 61000-6-4: 08-2002

- Tension de perturbation sur lignes conformément à EN 55022: 09-2003
- Puissance de perturbation conformément à EN 55022: 09-2003
- Courant harmonique (réseau rétroaction) conformément à EN 61000-3-2: 09-2005
- Flicker conformément à EN 61000-3-3: 05-2002

Immunité conformément à EN 61000-6-2: 03-2006

- Immunité contre un déchargement d'électricité statique conformément à EN 61000-4-2: 12-2001
- Champs électromagnétiques conformément à EN 61000-4-3: 11-2003
- Immunité contre perturbation (burst) rapide transitoire conformément à EN 61000-4-4: 07-2005
- Immunité contre tension transitoires (surge) conformément à EN 61000-4-5: 12-2001
- Tension HF conformément à EN 61000-4-6: 12-2001
- Interruptions de tension et abaissement de tension conformément à EN 61000-4-11: 02-2005



REMARQUE!

Il s'agit d'une machine de la classe A. Cette machine peut causer interférences dans le secteur de logement; dans ce cas on peut exiger d'opérateur d'exécuter des mesures appropriées et d'assumer pour cela.

Sécurité des machines

- EN 415-2 – Sécurité des machines d'emballage
- EN 60204-1:2006 – Sécurité des machines – Équipement électrique de machines – Partie 1

Connexions aux machines externes

Toutes les connexions devront comporter des filtres antiparasites. La tresse de blindage doit être fixée, sur une grande surface, des deux côtés du boîtier de connexion.

Il est interdit de guider les câbles parallèles aux lignes de courant. Dans le cas où une connexion parallèle ne peut pas être évitée, il faut observer une distance d'au moins 0,5 m.

Température des lignes: -15 jusqu'à +80 °C.

Il est seulement permis de connecter des appareils qui répondent à la demande «de sécurité très basse tension» (SELV). Ce sont généralement des dispositifs qui sont vérifiées et correspondant à la norme EN 60950.

Installation des lignes données

Les câbles de données doivent être protégés complètement et équipés avec des connecteurs enfichables métalliques ou métallisés. Des câbles blindés et des connecteurs enfichables sont nécessaires pour éviter l'émission et la réception de perturbations électriques.

Lignes admissibles

Lignes sans parasite: 4 x 2 x 0,14 mm² (4 x 2 x AWG 26)
 6 x 2 x 0,14 mm² (6 x 2 x AWG 26)
 12 x 2 x 0,14 mm² (12 x 2 x AWG 26)

Emetteurs et récepteurs doivent être tressés par paires.

Longueur max. des lignes Interface V 24 (RS232C) - 15 m avec max. 19200 bds
 Centronics - 3 m
 USB - 3 m
 Ethernet - 100 m

Circulation d'air

Pour éviter une accumulation de chaleur, la circulation d'air autour de l'appareil doit être garantie.

Valeurs limites

Protection selon IP:	20
Température ambiante °C (opération):	Min. +5 Max. +40
Température ambiante °C (transport, stockage):	Min. -25 Max. +60
Humidité atmosphérique % (opération):	Max. 80
Humidité atmosphérique % (transport, stockage):	Max. 80 (éviter que les appareils se couvrent de rosée)

Garantie

Nous ne sommes pas responsables de dommages occasionnés par:

- Inobservation de nos conditions d'opération et du manuel d'opération.
- Installation électrique incorrecte des environs.
- Modifications constructives de nos appareils.
- Programmation et opération incorrectes.
- Protection de données non exécutée
- Utilisation de pièces de rechange et d'accessoires pas originales.
- Usure naturelle et dégradation.

Si nos blocs d'impression directe sont installés et programmés, contrôler les nouveaux paramètres par une fonction test et une impression test. De cette façon, des résultats mauvais sont évités.

Seuls les opérateurs expérimentés sont autorisés à l'opération de nos blocs d'impression directe.

Contrôler le traitement correct de nos produits et répétez les cours d'instruction.

Nous ne prenons pas de garantie que les caractères décrits dans ce manuel existent dans tous les modèles. Due à nos efforts de développement et d'amélioration continués les dates techniques indiquées sont sous réserves de modification.

Causé par la mise au point continuée ou par les règlements des pays les illustrations et les exemples montrés dans ce manuel peuvent différer du type livré.

Pour éviter des dommages ou usure prématurée veuillez faire attention aux informations sur les matériaux autorisés et les indications sur le nettoyage.

Nous avons fait notre mieux d'écrire le manuel compréhensible pour soumettre le plus informations que possible. En cas de questions ou erreurs, envoyer les par email afin que nous puissions les corriger.

Déballer le bloc d'impression directe

- ⇒ Enlever le bloc d'impression du carton.
- ⇒ Vérifier l'état du bloc d'impression suite au transport.
- ⇒ Contrôler entièrement la livraison.

Étendue de la livraison

- Mécanique d'impression.
- Unité de contrôle.
- Cordon électrique.
- Câble de connexion (senseurs, power).
- Mini-régulateur.
- Manomètre.
- Tuyau pneumatique.
- Raccord.
- Accessoires I/O (connecteur femelle pour I/O, câble I/O 24).
- 1 rouleau de film transfert.
- Mandrin de film transfert vide, monté sur l'enrouleur de film transfert.
- Feuille de nettoyage pour la tête d'impression.
- Documentation.
- CD avec des pilotes.



REMARQUE!

Conserver l'emballage d'origine dans le cas d'un retour (maintenance).

Connexion à l'alimentation

Le bloc d'impression directe est équipé d'une alimentation en énergie à grand champ. Le fonctionnement avec une tension de réseau de 110-230 V / 50-60 Hz est possible sans intervention sur l'appareil.



ATTENTION!

Endommagement de l'appareil par des électricités de démarrage non définies.

- ⇒ Avant le raccordement au réseau, placer l'interrupteur sur la position 'O'.
- ⇒ Mettre le câble dans la prise de connexion réseau.
- ⇒ Enfiler la fiche du câble réseau dans la prise reliée à la terre.



REMARQUE!

En cas de mise à la terre insuffisante ou défailante, des perturbations de fonctionnement peuvent survenir.

Veiller à ce que tous les ordinateurs connectés au bloc d'impression directe ainsi que les câbles de raccordement soient reliés à la terre.

- ⇒ Raccorder le bloc d'impression directe à l'ordinateur ou au réseau avec un câble approprié.

Préparations pour la mise en route

- ⇒ Monter la mécanique d'impression.
- ⇒ Connecter tous câbles entre la mécanique d'impression et le boîtier de contrôle et protéger les câbles contre le desserrage involontaire.
- ⇒ Connecter la ligne à air comprimé.
- ⇒ Connectez l'unité de contrôle et PC par l'interface de module.
- ⇒ Connecter l'unité de contrôle et la machine d'emballage par entrées et sorties.
- ⇒ Brancher le câble secteur du boîtier de contrôle.

Contrôle d'impression

Etant donné que le bloc d'impression directe est toujours en mode contrôle vous pouvez seulement transmettre les ordres d'impression par l'interface (séquentiel, parallèle, USB ou Ethernet) mais vous ne pouvez pas les démarrer. L'impression est démarrée par un signal de départ sur l'entrée départ d'impression. Pour que l'unité de contrôle reconnaisse quand elle peut placer un signal de départ il est possible est nécessaire d'observer l'état d'impression par les sorties.

Mettre en service le bloc d'impression direct

Quand toutes les connexions sont réalisées

- ⇒ Mettre en marche le bloc d'impression directe à l'aide de l'interrupteur. Après avoir mis en marche le bloc d'impression directe, le menu principal apparait, celui-ci indique le type de bloc d'impression directe, la date et l'heure actuelle.
- ⇒ Insérer la cassette de film transfert. Après l'insertion de la cassette de film transfert, le mesurage du film transfert est commencé et la tête d'impression est déplacée dans la position d'impression.

Insertion de la cassette de film transfert



REMARQUE!

Comme une décharge électrostatique peut abîmer la couche fine de la tête d'impression et d'autres pièces électroniques, il est conseillé d'utiliser uniquement que des films transferts antistatique. L'utilisation de matériaux inadéquats peut entraîner des dysfonctionnements et la garantie peut expirer.

Couleur à l'extérieur



REMARQUE!

Avant de mettre en place un nouveau rouleau film transfert nous recommandons de nettoyer la tête d'impression avec le détergent pour la tête et le rouleau (97.20.002).

Veuillez observer les recommandations de manipulation pour l'utilisation d'isopropanol (IPA). En cas de contact avec les yeux ou la peau, rincer abondamment à l'eau courante. En cas d'irritation persistante, consulter un médecin. Assurer une ventilation suffisante.

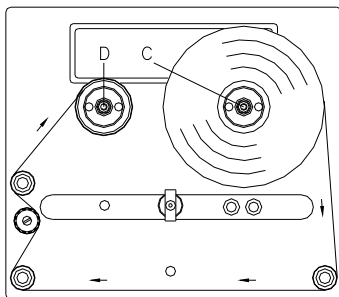
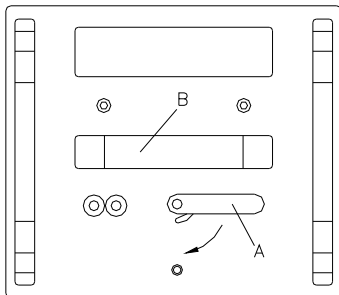

Le dessin dessus montre un système à gauche. Dans le cas où vous utilisez un système à droite, insérez le nouveau rouleau à gauche et le cœur de carton à droite.

- Tourner le levier (A) 90° dans le sens des aiguilles d'une montre.
- Enlever la cassette de film transfert en tirant à la poignée (B) de la mécanique d'impression.
- Placer un nouveau rouleau film transfert (A) sur le dérouleur (C) et le pousser jusqu'à la butée.
- Placer une douille vide sur l'enrouleur (D) et la pousser jusqu'à la butée.
- Insérer le film transfert selon l'illustration.
- A l'aide d'une bande adhésive, fixer le film transfert à la douille vide et après élaguer le film transfert avec quelques rotations de la douille.
- Pousser la nouvelle cassette de film transfert sur la mécanique d'impression et faire attention que le film transfert ne déchire pas.
- Tourner le levier (A) 90° dans le sens inverse des aiguilles d'une montre.

Couleur à l'intérieur

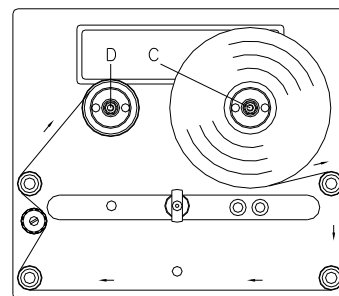
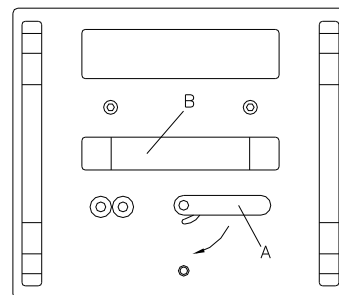

Le dessin dessus montre un système à gauche. Dans le cas où vous utilisez un système à droite, insérez le nouveau rouleau à gauche et le cœur de carton à droite.

- Tourner le levier (A) 90° dans le sens des aiguilles d'une montre.
- Enlever la cassette de film transfert en tirant à la poignée (B) de la mécanique d'impression.
- Placer un nouveau rouleau film transfert (A) sur le dérouleur (C) et le pousser jusqu'à la butée.
- Placer une douille vide sur l'enrouleur (D) et la pousser jusqu'à la butée.
- Insérer le film transfert selon l'illustration.
- A l'aide d'une bande adhésive, fixer le film transfert à la douille vide et après élaguer le film transfert avec quelques rotations de la douille.
- Pousser la nouvelle cassette de film transfert sur la mécanique d'impression et faire attention que le film transfert ne déchire pas.
- Tourner le levier (A) 90° dans le sens inverse des aiguilles d'une montre.

Print Settings (Initialisation)

Touches: **F**

Menu fonction
Initialisation

Touche:

Mode continu

Contraste
(en %): 100

Contrast (Contraste):

Valeurs possibles: 10% ... 200 %.

Mode intermittent

Vitesse: 100
Contraste: 100

Speed (Vitesse):

Valeurs possibles: 50 mm/s ... 200 mm/s.

Contrast (Contraste):

Valeurs possibles: 10% ... 200 %.

Touche:

Contrôle Ruban
ON sensil. faible

Transfer ribbon control (Contrôle film transfert):

Il permet de contrôler si le rouleau film transfert est fini ou si le film transfert est cassé.

Off: Le contrôle ruban est désactivé, c'est-à-dire le bloc d'impression directe continue d'imprimer sans message d'erreur.

On: Le contrôle ruban est actif, c'est-à-dire l'ordre d'impression courant est interrompu et un Message d'erreur s'affiche à l'écran.

strong sensibility (Sensibilité forte): Le bloc d'impression directe réagit immédiatement sur la fin du film transfert.

weak sensibility (Sensibilité faible): Le bloc d'impression directe réagit environ 1/3 plus lentement sur la fin du film transfert.

Touche:

Déplacement X
Offs (mm): -1.5

X-déplacement (Déplacement X):

Indication du déplacement en direction X. Déplacement des champs sur le layout en position horizontale.

Machine Parameters (Paramètres de machine)

Mode continu

Touches: **F**,

Menu fonction
Param. machine

Touche:

Mode
IO DY

Operating mode (Mode):

Sélection de mode d'utilisation.

Touche:

Offset impr.
(mm) 10.0

Print offset (Offset impression):

Distance de layout au point zéro de machine.

Valeurs possibles: 1 ... 999 mm

Touche:

Pos. impression
(mm) 20.0

Position d'impression:

Position de départ pour le chariot d'impression en mm.

Valeurs possibles: 12 ... 93 mm

Touche:

Layout/Cycle
1

Layouts/cycle (Layouts/cycle):

Procédures d'impression par longue d'impression.

Valeurs possibles: 1 ... 25 layouts par cycle.

Mode intermittent

Touches: **F**,

Menu fonction
Param. machine

Touche:

Mode
Mode continu

Operating mode (Mode):

Sélection de mode d'utilisation.

Touche:

Retour mm/s
400

Back speed (Vitesse de retour):

Vitesse de retour de mécanique après la fin d'impression en mm/s

Valeurs possibles: 50 ... 500 mm/s.

Touche:

Offset impr.
(mm) 10.0

Print offset (Offset impression):

Distance de layout au point zéro de machine.

Valeurs possibles: 1 ... 999 mm

Touche:

Pos. impression
(mm) 20.0

Position d'impression:

Position de départ pour le chariot d'impression en mm.

Valeurs possibles: 12 ... 93 mm

Mode continu

Touche: 

ChkSpeed On Strt
Off

Check speed on start (Vérifier la vitesse de matériel lors de démarrage d'impression):

Vérification vitesse matériel lors de signal démarrage de l'impression.

Touche: 

Res. mm/360°
2000 166

Encoder resolution / material feed per encoder rotation (Résolution encodeur / Avance du matériel):

Indication de la résolution de l'encodeur et l'avance du matériel par rotation de l'encodeur en mm.

Touche: 

Vitesse matériel
200 mm/s

Material speed (Vitesse matériel):

Indication de la vitesse de matériel.

Mode intermittent

Touche: 

Layout/Cycle
1

Layouts/cycle (Layouts/cycle):

Procédures d'impression par longue d'impression. Valeurs possibles: 1 ... 25 layouts par cycle.

Layout Settings (Layout)

Touches:   

Menu fonction
Layout

Touche: 

Longueur (mm)
140.0

Print length (Longueur):

Indication de la route pour la mécanique. La longueur d'impression dépend de la longueur de la mécanique.

Touche: 

Largeur: 20.0
Num. colonnes: 4

Column printing (Impression en plusieurs colonnes):

Indication de la largeur de layout ainsi que de l'indication du nombre de layouts se trouvant cote à cote sur la bande.

Touche: 

Sélect. matériel
Type 1

Material selection (Sélection matériel):

Sélection du matériel utilisé.

Touche: 

Retourner layout
Off

Flip layout (Retourner layout):

Le layout s'imprime en mode miroir. Si la largeur de layout n'a pas été transférée au bloc d'impression directe, la largeur de défaut est utilisée, c'est-à-dire la largeur de la tête d'impression. Pour cette raison, faire attention à ce que le layout soit aussi large que la tête d'impression. Autrement cela pourrait causer des problèmes lors de la mise en page.

Touche: 

Faire pivoter
On

Rotate layout (Faire pivoter):

Par défaut le layout est imprimé en avant avec une rotation de 0°. Si la fonction est activée, le layout est tourné de 180° et s'imprime dans le sens de la lecture.

Touche: 

Alignement
A gauche

Alignment (Alignement):

L'alignement de layout est effectuée après 'retourner/faire pivoter layout', c.-à-d. l'alignement est indépendant des fonctions retourner et faire pivoter.

Left (A gauche): Le layout est aligné au bord gauche de la tête d'impression.

Centre (Centré): Le layout est aligné au point central de la tête d'impression.

Right (A droite): Le layout est aligné au bord droit de la tête d'impression.

Ribbon Save (Optimisation) - Mode continu

Touches: **F**, , , 

Menu fonction
Optimisation

Touche: 

Mode Speed
Standard 600

Mode (Mode d'exploitation):

Sélection de type de l'optimisation.

Off: L'optimisation est validée hors marche.

Standard (Standard): La performance d'optimisation maximale, c.-à-d. avec ce réglage il n'y a pas de perte de film transfert (sauf une distance de sauvegarder de 1 mm, afin que les champs ne soient pas imprimés l'un dans l'autre).

SaveStrt (Enregistrer signal de départ): Aucune perte de signal de départ. L'appareil règle la qualité d'optimisation automatiquement selon la demande.

Speed (Vitesse): Détermination de la vitesse d'impression max.

Sur la base de cette valeur, tous les calculs nécessaires sont exécutés

Mode: Standard

R-Correction
-1 mm

Transfer ribbon correction (Correction film transfert):

0 mm = Il est toujours retiré afin d'atteindre une optimisation optimale (aucune perte de film transfert).

Défaut: 0 mm

-xx mm = Le retrait peut être réduit.

+xx mm = Le retrait peut être agrandi.

Touche: 

sa/mm cmin so/mm
303 1000 10

Performance information (Informations de performance):

sa/mm: La petite possible distance de deux impressions lors d'une optimisation pleine

cmin: Max. numéros des tacts par minute.

so/mm: Indication de perte d'optimisation,

Touche: 

ExpertParameters

Expert parameters (Paramètres d'experts): protégé par mot de passe

Entrer le mot de passe, appuyer sur la touche  pour confirmer l'entrée et les paramètres suivants sont indiqués.

Touche: 

PhDownT REStartT
30 ms 10 ms

PhDownT = Printhead down time (Tête vers le bas) in ms:

Le commencement de mouvement vers le bas de tête d'impression est calculé.

REStartT = Ribbon motor early start time (Moteur film transfert temps départ) in ms:

Cette valeur est ajoutée au temps d'augmentation du mouvement de film transfert. Indication pour le temps entre 'moteur arrive vitesse de matériel' et 'tête d'impression allumée'.

Touche: 

MinSpeed Calcoeff
50 mm/s On

MinSpeed = Minimal print speed (Min. vitesse d'impression):

Si la min. vitesse d'impression est augmentée, le nombre max. des cycles augmente aussi.

Calcoeff = Print offset border calculation (Calcul limites d'offset):

Si le paramètre est validée sur Off, on peut entrer un offset d'impression le plus petit que nécessite.

Touche: 

PhUpT PhVReactT
20 ms 10 ms

PhUpT = Printhead up time (Tête vers le haut) in ms:

Le calcul si une optimisation de champ est possible ou pas.

PhVReactT = Printhead valve reaction time (Temps de réaction) in ms:

Le calcul quand le mouvement vers le bas de tête d'impression est commencé.

Touche: 

RibMotStpDlayT
2 ms

RibMotStpDlayT = Ribbon motor stop delay time (Temps de décélération)

Temps de retard en ms qui le moteur film transfert a encore mû avant de s'arrêter avec la vitesse constante.

Touche: 

FieldRS Rwind v
Normal 600mm/s

FieldRS = Field ribbon saving (Optimisation champ):

Off: Optimisation de champ hors marche.

PHOnly: Seulement la tête d'impression a mû. Le film transfert n'est pas arrêté.

Normal (Standard): L'optimisation de champ est seulement exécutée si le moteur film transfert est arrêté complètement.

Strong (Fort): L'optimisation de champ est exécutée même si le moteur film transfert n'est pas arrêté.

Rwind v = Rewind speed (Vitesse de retour) in mm/s:

Indication de retour en mm/s.

Touche: 

Speed 1. Field
400 mm/s

Speed 1 field (Vitesse champ 1):

Si 0 (valeur de défaut) est réglé, le paramètre n'a pas d'influence sur l'optimisation.

Touche: 

Tension
0 mm

Tension (Tension):

Indication de la longueur qui est transportée en avant après mesurer le film transfert.

Mode: Shift

X-Shift Y-Shift
10 mm 13 mm

X-Shift / Y-Shift (Déplacement X / Y):

X-Shift (Déplacement X): Indication du décalage de l'impression en direction X.

Y-Shift (Déplacement Y): Indication du décalage en direction de l'impression.

Touche: 

Lanes R-Shift
3 -5 mm

Lanes / R-Shift (Colonnes/Déplacement R):

Lanes (Colonnes): Indication du nombre des cycles imprimés côte à côte.

R-Shift (Déplacement R): Indication de la distance avec le changement sur un nouveau cycle.

Touche: 

ExpertParameters

**Expert parameters (Paramètres d'experts):
protégé par mot de passe**

Entrer le mot de passe et appuyer sur la touche pour confirmer l'entrée.

La description des paramètres peut être trouvée sous le mode 'Standard'.

Mode: SaveStrt

ExpertParameters

**Expert parameters (Paramètres d'experts):
protégé par mot de passe**

Entrer le mot de passe et appuyer sur la touche pour confirmer l'entrée.

La description des paramètres peut être trouvée sous le mode 'Standard'.

Ribbon Save (Optimisation) - Mode intermittent

Touches: **F**, , , 

Menu fonction
Optimisation

Touche: 

Mode
Standard

Mode (Mode d'exploitation):

Sélection de type de l'optimisation.

Off: L'optimisation est validée hors marche.

Standard (Standard): La performance d'optimisation maximale, c.-à-d. avec ce réglage il n'y a pas de perte de film transfert (sauf une distance de sauvegarder de 1 mm, afin que les champs ne soient pas imprimés l'un dans l'autre).

Shift (Déplacement): Des données de layout peuvent être imprimées à plusieurs fois latéralement déplacé. De cette manière une utilisation maximale du film transfert peut être atteinte.

Mode: Standard

R-Correction
-1 mm

Transfer ribbon correction (Correction film transfert):

0 mm = Il est toujours retiré afin d'atteindre une optimisation optimale (aucune perte de film transfert).

Défaut: 0 mm

-xx mm = Le retrait peut être réduit.

+xx mm = Le retrait peut être agrandi.

Touche: 

ExpertParameters

Expert parameters (Paramètres de l'expertes):

protégé par mot de passe

Entrer le mot de passe, appuyer sur la touche  pour confirmer l'entrée et les paramètres suivants sont indiqués.

Touche: 

PhDownT PhUpT
35 ms 0 ms

PhDownT = Printhead down time (Tête vers le bas) in ms:

Le commencement de mouvement vers le bas de tête d'impression est calculé.

PhUpT = Printhead up time (Tête vers le haut) in ms:

Le calcul si une optimisation de champ est possible ou pas.

Touche: 

PhVReactT
10 ms

PhVReactT = Printhead valve reaction time (Temps de réaction) in ms:

Le calcul quand le mouvement vers le bas de tête d'impression est commencé.

Touche: 

Tension RM
0 mm 0

Tension / Ribbon Mode (Tension / Mode film transfert):

Tension (Tension): Indication de la longueur qui est transportée en avant après mesurer le film transfert.

Ribbon mode (Mode film transfert):

0: Le film transfert est retourné après chaque impression sur la longueur d'impression totale, c.-à-d. il n'y a pas d'optimisation entre les layouts.

1: Le film transfert est retourné seulement sur la zone imprimée, c.-à-d. les espaces entre les layouts sont optimisés.

Au changement de layout, le film transfert est positionné automatiquement.

Mode: Shift

X-Shift Y-Shift
10 mm 13 mm

X-Shift / Y-Shift (Déplacement X / Y):

X-Shift (Déplacement X): Indication du décalage de l'impression en direction X.

Y-Shift (Déplacement Y): Indication du décalage en direction de l'impression.

Touche: 

Lanes R-Shift
3 -5 mm

Lanes / R-Shift (Colonnes/Déplacement R):

Lanes (Colonnes): Indication du nombre des cycles imprimés côte à côte.

R-Shift (Déplacement R): Indication de la distance avec le changement sur un nouveau cycle.

Touche: 

ExpertParameters

Expert parameters (Paramètres d'experts):

protégé par mot de passe

Entrer le mot de passe et appuyer sur la touche  pour confirmer l'entrée.

La description des paramètres peut être trouvée sous le mode 'Standard'.

Device Settings (Paramètres d'appareil)

Touches:     

Menu fonction
Param. appareil

Touche: 

Contrôle champ
OFF

Field handling (Contrôle de champ):

Off: La mémoire de bloc d'impression directe est complètement supprimée.

Keep graphic (Graphique reçu): Un graphique ou bien une police TrueType sont transmis une fois au bloc d'impression directe et sont mémorisés dans la mémoire interne. Lors des prochains ordres d'impression, il n'y a que les données modifiées qui sont transmises au bloc d'impression directe. Ici l'avantage est d'économiser le temps pour transmettre les données graphiques.

Les données graphiques créés par le bloc d'impression directe (les polices internes, les codes à barres, ...) sont générées uniquement si elles ont été modifiées.

Delete graphic (Graphique effacer): Les graphiques ou bien les polices TrueType mémorisés dans la mémoire interne sont effacés mais pas les autres champs

Touche: 

Page de code
GEM français

Codepage (Page de code):

Indication de la page de caractère utilisée par le bloc d'impression directe.

Touche: 

Paramètre ext.
ON

External parameters (Paramètres externes):

Layout dimension only (Seulement dimension layout): Les paramètres pour la longueur de layout, l'espace entre deux layouts et la largeur de layout peuvent être transmis. Tous les autres paramètres doivent être faits directement au système d'impression.

On: Il est possible de transmettre les paramètres comme par exemple la vitesse d'impression et le contraste via notre logiciel de création de layouts au module directe. Les paramètres qui sont réglés auparavant directement sur le module directe ne sont plus pris en considération.

Off: Seul les réglages effectués directement sur le bloc d'impression directe sont pris en considération.

Touche: 

Buzzer
On

Buzzer (Buzzer):

On: Appuyer sur une touche pour entendre un signal acoustique. Valeurs possibles: 1 ... 7.

Off: On ne peut entendre le signal acoustique.

Touche: 

Langue
Français

Language (Langue):

Sélection de la langue dans laquelle les textes à l'écran sont indiqués. Actuellement les langues suivantes sont disponibles: allemande, anglaise, française, espagnole, portugaise, néerlandaise, italienne, danoise, finlandaise, polonaise, tchèque et russe.

Touche: 

Entrée person.
On

Customized entry (Entrée personnalisée):

On: La question de la variable personnalisée s'affiche uniquement avant l'impression à l'écran.

Auto: La question de la variable personnalisée s'affiche après chaque layout.

Off: Il n'y a pas de question pour la variable personnalisée. Dans ce cas une valeur par défaut est imprimée.

Touche: 

Hotstart
Off

Hotstart (Hotstart):

On: C'est possible de continuer un ordre d'impression interrompu après avoir allumé de nouveau le bloc d'impression directe (seulement si le bloc d'impression directe est équipé avec l'option carte Compact Flash).

Off: Après avoir éteint le bloc d'impression directe toutes les données se perdent.

Touche: 

Mot de passe
Active

Password (Mot de passe):

A l'aide d'un mot de passe on peut bloquer certaines fonctions pour que l'opérateur ne puisse pas travailler avec elles. Il y a plusieurs applications où la protection par mot de passe est nécessaire.

Touche: 

Confirm. layout
On

Layout confirmation (Confirmation layout):

On: Un nouvel ordre d'impression est imprimé après la confirmation à la machine.

Un ordre d'impression continu actif est imprimé tant que la confirmation n'a pas été effectuée à la machine.

Off: Il n'y a pas d'interrogation au display de boîtier de contrôle.

Touche: 

Layout standard
Off

Standard layout (Layout standard):

On: Si un ordre d'impression débute sans définition de layout précédente, le layout standard (type d'appareil, version de firmware, version build) est imprimé.

Off: Si un ordre d'impression débute sans définition de layout précédente, un message d'erreur apparaît.

I/O Parameters (I/O Paramètres)

Touches: **F**, , , , , 

Menu fonction
I/O Paramètre

Taste: 

IN niveau signal
1s2x3+4x5x6x7x8x

IN signal level (IN niveau signal):

Indication du signal par lequel un ordre d'impression est démarré.

+ = le niveau du signal est actif à l'état haut (1)

- = le niveau du signal est actif à l'état bas (0)

x = le niveau du signal non actif

s = le niveau peut être influencé par l'interface (en connexion avec Netstar PLUS)

Taste: 

OUT niveau sign.
1+2+3+4+5+6+7+8+

OUT signal level (OUT niveau signal):

Indication du niveau signal pour signal sortie.

+ = le niveau du signal est actif à l'état haut (1)

- = le niveau du signal est actif à l'état bas (0)

s = le niveau peut être influencé par l'interface (en connexion avec Netstar PLUS)

Taste: 

Debounce (ms)
50

Debouncing (Debounce):

Indication du temps de l'anti-rebond de l'entrée distributeur.

Valeurs possibles: 0 à 100 ms.

Taste: 

Retard démar. (s)
1.00

Start signal delay (Retard démarrage):

Indication du retard de signal de départ. Avec ce réglage on peut retarder le départ de l'impression.

Valeurs possibles: 0.00 ... 9.99.

Taste: 

ErrorIfNotReady
On

Not ready: error (Non prêt: erreur):

On: Falls ein Druckauftrag aktiv ist aber das Direktdruckwerk nicht bereit ist diesen zu verarbeiten (z.B. weil bereits im 'druckend' Mode), wird ein Fehler ausgelöst.

Off: Es wird keine Fehlermeldung ausgelöst.

Taste: 

Prêt pend impr.
Off

Ready while printing (Prêt pendant impression):

Réglage, si le signal de sortie 'impression prête' (Out 5, Output II) reste actif pendant de l'impression.

Off: Au démarrage de l'impression, le signal 'impression prête' est inactif (réglage par défaut).

On: Au démarrage de l'impression, le signal 'impression prête' reste actif.

Network (Réseau)

Touches: **F**, , , , , , 

Menu fonction
Réseau

Pour des informations plus détaillées concernant ce point de menu, voir le manuel réseau.

Remote Console (Remote console)

Touches: **F**, , , , , , 

Menu fonction
Remote Console

Pour plus d'informations, contacter notre département de vente.

Interface (Interface)

Touches: **F**, , , , , , , , 

Menu fonction
Interface

Touche: 

COM1	Baud	P	D	S
0	9600	N	8	2

COM1:

0 - Port série Off

1 - Port série On

2 - Port série On; mais en cas d'une erreur de transmission il n'y a pas de message d'erreur.

Baud (Baud):

Indication combien de Bits sont transmis par seconde.

Valeurs possibles: 1200, 2400, 4800, 9600, 19200, 38400, 57600 et 115200.

P = Parity (Parité):

N - Non parité

E - Pair (even)

O - Impair (odd)

Faire attention à ce que les réglages soient identique entre le bloc d'impression directe et l'ordinateur.

D = Data bits (Bits de données):

Réglage des bits de données.

Valeurs possibles: 7 ou 8 bits.

S = Stop bits (Bits d'arrêt):

Indication des bits d'arrêt entre les bytes.

Valeurs possibles: 1 ou 2 bits d'arrêt.

Touche: 

Départ (SOH):	01
Fin (ETB):	17

Start/stop sign (Signe de départ/fin):

SOH: Début de trame → Hex-Format 01

ETB: Fin de trame → Hex-Format 17

Touche: 

Mémoire données
Elarqit

Data memory (Mémoire données):

Standard (Défaut): Après avoir démarré un ordre d'impression, le bloc d'impression directe peut recevoir des données jusqu'à ce que le buffer d'impression soit plein.

Extended (Elargit): Pendant un ordre d'impression, les données sont reçues et traitées en même temps.



Off: Tant qu'un ordre d'impression est en cours, le bloc d'impression directe ne peut pas recevoir de données.

Touche: 

Contr. interface
Off

Port test (Contrôle interface):

Vérification si des données sont transférées sur l'interface.

Appuyer sur les touches  et  pour sélectionner 'Général' (On). Appuyer sur la touche

 et les données qui sont envoyées sur un port arbitraire (COM1, LPT, USB, TCP/IP) sont imprimées.

Emulation (Emulation)

Touches: **F**, , , , , , 

Menu fonction
Emulation



Touche: 

Protocole
ZPL

Protocol (Protocole):

CVPL: Carl Valentin Programming Language

ZPL: Zebra® Programming Language

Appuyer sur les touches  et  pour sélectionner le protocole. Appuyer sur la touche  pour confirmer la sélection. Le bloc d'impression directe est démarrée de nouveau et les commandes ZPL II® sont transformées dans les commandes CVPL.

Touche: 

Résolution tête
11.8 (Dot/mm)

Printhead resolution (Résolution de la tête d'impression):

Avec l'émulation ZPL II® active, la résolution de la tête d'impression du bloc d'impression directe émulée doit être réglée

Touche: 

Allocation lect.
B: ->A: R: ->R:

Drive mapping (Allocation lecteur):

L'accès aux lecteurs Zebra® a dérivé sur les lecteurs Valentin correspondants.

Date & Time (Date & Heure)

Touches: **F**, , , , , , , , , , 





Menu fonction
Date/Heure

Touche: 

Date 17.11.04
Heure 13:28:06

Set date/time (Modification de la date et de l'heure):

La première ligne de l'écran indique la date actuelle et la deuxième ligne l'heure actuelle.

Appuyer sur les touches  et  pour arriver au prochain champ. Utiliser les touches  et  pour augmenter et/ou diminuer les valeurs indiquées.

Touche: 

Heure d'été
On

Summertime (Heure d'été):

On: Le bloc d'impression directe passe automatiquement l'heure d'été ou bien d'hiver.

Off: L'heure d'été n'est pas automatiquement détectée et convertie.

Touche: 

HE format début
WW/WD/MM

Start of summertime - format (Début de l'heure d'été – Format):

Sélection de format pour entrer le début de temps d'été.

DD = jour

WW = semaine

WD = jour de semaine

MM = mois

YY = année,

next day = est pris en compte que le lendemain

Touche: 

WW WD MM
dern. dimanche03

Start of summertime - date (Début de l'heure d'été – Date):

Entrée la date du passage à l'heure d'été. Cette entrée se réfère au format sélectionné auparavant.

Dans l'exemple, le passage à l'heure d'été est activé automatiquement le dernier dimanche de Mars (03).

Touche: 

HE heure début
02:00

Start of summertime - time (Début de l'heure d'été – Heure):

Entrée l'heure du passage à l'heure d'été.

Touche: 

HH format fin
WW/WD/MM

End of summertime - format (Début de l'heure d'hiver - Format):

Sélectionner le format d'entrer du passage à l'heure d'hiver. L'exemple montre le réglage par défaut (format européen).

Touche: 

WW WD MM
dern. dimanche10

End of summertime - date (Début de l'heure d'hiver - Date):

Entrée la date du passage à l'heure d'hiver. Cette entrée se réfère au format sélectionné auparavant.

Touche: 

HH heure fin
03:00

End of summertime - time (Début de l'heure d'hiver – Heure):

Entrée l'heure du passage à l'heure d'hiver.

Touche: 

Décalage horaire
01:00

Time shifting (Décalage horaire):

Entrée le décalage horaire en heures et minutes lors du passage heure d'été/heure d'hiver.

Service Functions (Fonctions service)



REMARQUE!

Pour que le distributeur ou bien le fabricant d'imprimante soit à même d'offrir son soutien, en cas de panne, les informations nécessaires comme par exemple les paramètres réglés, peuvent être lues directement à l'unité de contrôle.

Touches: **F**, , , , , , , , , , , ,

Menu fonction
Fonct. Service

Touche:

H P R1 R2 C ENC
0 1 1 0 0 0

Photocell parameters (Paramètres des cellules):

H = Interrupteur de couvercle (seulement pour des appareils avec un interrupteur)

0 = couvercle ouvert

1 = couvercle fermé.

P = Pressure:

Indication des valeurs 0 ou 1 pour la contrôle air comprimé.

R1 = Enrouleur film transfert

Indication des valeurs 0 à 2 pour l'état de l'enrouleur film transfert.

4 états sont indiqués (aucun marquage en la cellule, marquage de droite, marquage de gauche, marquage complet en la cellule).

R2 = Dérouleur film transfert:

Indication des valeurs 0 à 2 pour l'état de dérouleur film transfert.

4 états sont indiqués (aucun marquage en la cellule, marquage de droite, marquage de gauche, marquage complet en la cellule).

C = Carriage:

Indication de la position du chariot de l'impression.

ENC = Encoder:

Indication de l'état actuelle de l'encodeur.

Touche:

Kilométrage
D000007 G000017

Paper counter (Kilométrage):

D: Indication du kilométrage de la tête d'impression mètres.

G: Indication du kilométrage de la mécanique en mètres.

Touche:

Résistance Dot
1250

Heater resistance (Résistance dot):

Pour obtenir une bonne impression, il faut régler après un changement de la tête d'impression la valeur ohmique indiquée sur la tête d'impression.

Touche:

Températ. tête
23

Printhead temperature (Température de la tête d'impression):

Indication de la température de la tête d'impression.

Touche:

Ribbon Ink Side
600 m Out

Ribbon / Ink side (Longueur film transfert / Bobiange):

Ribbon: Sélection de la longueur de film transfert utilisée (300 m, 450 m, 600 m, 900 m, 1000 m). Avec de plus petites films transfert, une performance de cycle plus élevée peut être atteinte.

Ink side:

Sélection si les films transfert avec la couleur à l'extérieur ou à l'intérieur sont utilisés.

Défaut: Couleur à l'extérieur

Touche:

BrkPow BrkPowP
100 % 100 %

Brake power (Performance frein):

BrkPow: Réglage de la performance du frein pour l'accélération et le freinage en %.

BrkPowP: Réglage de la performance du frein pendant de l'impression.

Touche:

Exemple impr.
Paramètres

Print examples (Exemples d'impression):

Tous les réglages du module d'impression ont été imprimés sur l'étiquette insérée.

Settings (Paramètres): Impression de tous les paramètres (par ex: vitesse, matériel et du film transfert etc.).

Bar codes (Codes à barres): Impression de tous les codes à barres disponibles.

Fonts (Fonts): Impression de toutes les polices bitmap et vectoriels.

Touche:

Entrée: 11111111
Sortie: 00000000

Input/Output (Entrées/Sorties):

Affichage du niveau du signal qui indique que le signal de l'impression est démarrée.

0 - Low

1 - High

Touche: Diagnostic
Enter**Diagnostic (Diagnose):**Appuyer sur la touche  pour arriver au menu Diagnostic.Touche: EncProf NoOfProf
Off 10**Encoder profiling (Profil encodeur):**

Les valeurs d'encodeur avec le départ d'impression dans des fichiers logging sont enregistrées sur la carte CF. A l'aide de ces données, un diagramme graphique de la courbe d'encodeur peut être créée.

Touche: DiaRU DiaRW
68mm 655mm**Roller diameter (Diamètres des rouleaux film transfert):****DiaRW** = Diamètre d'enrouleur film transfert.
DiaRU = Diamètre de dérouleur film transfert.Touche: Encodeur moyen
100**Encoder average (Signaux encodeur):**

Nombre des valeurs par lesquelles les signaux de l'encodeur peuvent être moyennés.

Touche: IgnrStrt IntPrts
123 456**Diagnostic - Counter (Diagnose - Zähler):****IgnrStrt** = Compteur pour les signaux de départ ignorés.
IntPrts = Compteur pour des ordres d'impression interrompus
Sélectionner avec le curseur la valeur sur laquelle vous voulez savoir plus et appuyer sur la touche .Touche: Njb Nrd Prt
+000 +999 +999**NJb =No job (aucun ordre d'impression):**

Compteur pour les signaux de départ ignorés parce que l'ordre d'impression n'était pas prêt.

NRd = Not ready (pas prêt):

Compteur pour les signaux de départ ignorés bien que l'ordre d'impression n'était pas prêt (arrêté ou message d'erreur).

Prt = Printing (imprimer):

Compteur pour les signaux de départ ignorés pendant l'appareil imprime/travaille.

Touche: MS/I ItfI SpdS
+000 +999 +999**MS/I = Manual stopped/interrupted (arrêté/interrompu manuellement):**



La touche stop sur le clavier interne, panel ou dans un programme a été appuyée.

ItfI = Interface interrupted (interface interrompue):

L'ordre d'impression a été interrompu parce que des nouvelles données ont été reçues sur une interface.

SpedS = Speed stopped (vitesse arrêtée):

L'ordre d'impression a été interrompu parce que la vitesse d'impression mesurée était trop lente.

Touche: On/Offline
Off**Online/Offline (Online/Offline):**Cette fonction est activée par exemple si le film transfert doit être changé. Il permet d'éviter qu'un ordre d'impression soit traité bien que le bloc d'impression directe ne soit pas prêt. Si cette fonction est active, appuyer sur la touche  pour passer du mode Online au mode Offline. L'état est indiqué à l'écran.
Défaut: Off**Online (Online):** Les données peuvent être reçues par les interfaces. Les touches du clavier interne ne sont qu'actives que lorsqu'on passe avec la touche  dans le mode Offline.**Offline (Offline):** Les touches de clavier interne sont toujours actives mais les données reçues ne sont plus traitées. Si le bloc d'impression directe est encore en mode Online, des nouveaux ordres d'impression peuvent être encore reçus.Touche: Signal film
On ø: 40 v:100**Transfer ribbon prior warning (Pré-fin film transfert):**

Avant la fin du film transfert, un signal apparaît sur la sortie.

Warning diameter (Diamètre pré-fin film transfert):

Réglage du diamètre du rouleau film transfert pour l'avertissement.

Dans le cas où vous entrez une valeur en mm, un signal apparaît sur OUTPUT2 lorsque que le diamètre est atteint (mesuré au rouleau film transfert).

v = reduced speed (Vitesse d'impression réduite):

Réglage de la vitesse d'impression réduite. Cela peut être réglé dans les limites de la vitesse normale.

-: Aucune vitesse d'impression réduite.

0: Le bloc d'impression directe s'arrête lorsqu'il a atteint le diamètre de pré-fin film en indiquant une 'erreur film transfert'.

Main Menu (Menu principal)

Après la mise en route du bloc d'impression directe, l'écran suivant apparaît:



<pre>* DC c107-12K * 14/09/05 10:16</pre>	<p>Première ligne = le type de bloc d'impression directe. Deuxième ligne = la date et l'heure actuelle.</p>
<p>Touche: <input type="radio"/></p>	
<pre>* DC c107-12K * V1.44</pre>	<p>Deuxième ligne = le numéro de version du Firmware.</p>
<p>Touche: <input type="radio"/></p>	
<pre>* DC c107-12K * Build 0201</pre>	<p>Deuxième ligne = la version Build du software.</p>
<p>Touche: <input type="radio"/></p>	
<pre>* DC c107-12K * Jun 2 2005</pre>	<p>Deuxième ligne = la date de création du Firmware.</p>
<p>Touche: <input type="radio"/></p>	
<pre>* DC c107-12K * 10:37:34</pre>	<p>Deuxième ligne = l'heure de création du Firmware.</p>
<p>Touche: <input type="radio"/></p>	
<pre>* DC c107-12K * E-Font: V5.01</pre>	<p>Deuxième ligne = la version des polices bitmap.</p>
<p>Touche: <input type="radio"/></p>	
<pre>* DC c107-12K * V-Font: V1.01</pre>	<p>Deuxième ligne = la version des polices vectorielles.</p>
<p>Touche: <input type="radio"/></p>	
<pre>* DC c107-12K * FPGA V1.4.0 T9</pre>	<p>Deuxième ligne = la version de FPGA.</p>
<p>Touche: <input type="radio"/></p>	
<pre>* DC c107-12K * 16 MB Memory</pre>	<p>Deuxième ligne = la capacité de mémoire de bloc d'impression directe en MB.</p>
<p>Touche: <input type="radio"/></p>	
<pre>* DC c107-12K * 8 MB FLASH</pre>	<p>Deuxième ligne = la capacité de mémoire en MB du FLASH.</p>
<p>Touche: <input type="radio"/></p>	
<pre>* DC c107-12K * A0 MO V.1.3.1 AB</pre>	<p>Deuxième ligne = la version pour le premier processeur (contrôle de moteur).</p>
<p>Touche: <input type="radio"/></p>	
<pre>* DC c107-12K * A1 MO V.1.3.1 AB</pre>	<p>Deuxième ligne = la version pour le deuxième processeur (contrôle de moteur).</p>
<p>Touche: <input type="radio"/></p>	
<pre>* DC c107-12K * A2 IO V.1.3.1 AB</pre>	<p>Deuxième ligne = la version pour le troisième processeur (contrôle I/O).</p>

CF Card (Carte Compact Flash)

Select layout (Sélectionner un layout)

Touches: 

```
→layout01 0
A:\STANDARD
```

Appuyer sur les touches  et  pour sélectionner le layout désiré dans le répertoire STANDARD.

Appuyer sur la touche  pour sélectionner le layout.

Sélectionner la quantité des layouts qui doivent être imprimés.

Appuyer sur la touche  pour démarrer l'ordre d'impression.

```
Démarrage impr.
Quantité: 12345
```

Load file (Charger un fichier)



Touches: , 

```
Fonctions CF
Charger fichier
```

Touche: 

```
□→ .. <
A:\STANDARD
```

Sélectionnez le fichier désiré et confirmez votre sélection avec .

Appuyez sur la touche  et entrez le numéro que vous voulez imprimer. Confirmer la sélection avec  et l'ordre d'impression est démarré par un signal externe (Input 1, PIN 1 et PIN 4).

Save layout (Mémoriser layout)

Touches: , , 

```
Fonctions CF
Mémoriser layout
```

Touche: 

```
Fichier existe
surécrire?
```

Sélectionnez le repertoire/layout que vous voulez mémoriser et confirmez votre sélection avec .

Confirmez la question ci-dessus avec  et le layout est mémorisé.

Save configuration (Mémoriser la configuration)

Touches: , , , 

```
Fonctions CF
Mémoriser config
```

En standard, le nom config.cfg est proposé pour le fichier de configuration. Le nom peut être modifié par l'utilisateur. Dans ce fichier, les paramètres du bloc d'impression directe sont mémorisés et ne sont pas sauvegardés dans la mémoire Flash interne.

Appuyer sur la touche  pour démarrer la mémorisation.

Change directory (Changer le répertoire)



Touches: , , , , 



```
Fonctions CF
Changer répert.
```

Touche: 

```
←<.> M
A:\STANDARD\
```

Le répertoire actuellement sélectionné est indiqué dans la ligne inférieure.

Appuyer sur les touches  et  pour changer de répertoire dans la ligne supérieure.

Appuyer sur les touches  et  pour indiquer les répertoires disponibles.

Appuyer sur la touche  pour confirmer le répertoire sélectionné.

Delete file (Effacer fichier)

Touches: , , , , , 

Fonctions CF
Effacer fichier

Sélectionnez le répertoire ou bien le layout que vous voulez effacer et confirmez votre sélection avec .

Format CF card (Formater carte CF)

Touches: , , , , , , 

Fonctions CF
Formater

Touche: 

Formater A:

Sélectionnez le répertoire de la carte mémoire avec la touche  et confirmez votre sélection avec . Le répertoire STANDARD est créé automatiquement.

Free memory space (Indiquer la mémoire libre)

Touches: , , , , , , 

Fonctions CF
Mémoire libre

Sélectionnez le menu mémoire libre pour afficher l'emplacement de mémoire libre disponible sur la carte Compact Flash.

Données techniques

	Dynacode 53	Dynacode 107	Dynacode 128
Résolution	300 dpi	300 dpi	300 dpi
Vitesse d'impression			
Mode continu	50 ... 800 mm/s	50 ... 600 mm/s	50 ... 450 mm/s
Mode intermittent	50 ... 600 mm/s	50 ... 600 mm/s	50 ... 600 mm/s
Vitesse de retour	seul en mode intermittent: max. 600 mm/s		
Largeur d'impression	53,3 mm	106,6 mm	128 mm
Longueur max. d'impression			
Mode continu	6000 mm	3000 mm	3000 mm
Mode intermittent	75 mm	75 mm	75 mm
Largeur de passage cadre	personnalisé	personnalisé	personnalisé
Tête d'impression	Corner Type	Corner Type	Corner Type
Émission acoustique (distance de mesure 1 m)			
Niveau de puissance acoustique moyen	60 dB(A)	65 dB(A)	68 dB(A)
Film transfert			
Couleur	extérieur/intérieur (option)	extérieur/intérieur (option)	extérieur/intérieur (option)
Diamètre max. de rouleau	98 mm	82 mm	75 mm
Diamètre intérieur	25,4 mm / 1"	25,4 mm / 1"	25,4 mm / 1"
Max. longueur	900 m	600 m	450 m
Max. largeur	55 mm	110 mm	130 mm
Dimensions (largeur x hauteur x profondeur)			
Mécanique d'impression			
sans cadre	204 x 180 x 234 mm	204 x 180 x 290 mm	204 x 180 x 312 mm
avec cadre	dépendant de la largeur de passage		
Unité de contrôle	240 x 125 x 332 mm jeu de câble de connexion à la mécanique 2,5 m		
Poids			
Mécanique d'impression	9,5 kg	11 kg	11,7 kg
Unité de contrôle avec câble	5,5 kg	5,5 kg	5,5 kg
Électronique			
Processeur	High Speed 32 Bit		
Mémoire vive (RAM)	16 MB / 64 MB (sur demande)		
Emplacement	pour carte Compact Flash Type I / pour carte Wireless LAN		
Batterie (horloge temps réel)	sauvegarde des données lors d'un débranchement de courant		
Buzzer de signalment	signal acoustique en cas d'erreur		
Interface			
Seriell	RS-232C (jusqu'à 115.200 Baud)		
Parallèle	Centronics		
Ethernet	10/100 Base T		
USB	1.1		
Valeurs de connexion			
Connexion pneumatique	min. 6 bar sèche et sans huile		
Tension nominale	110 ... 230 V / 50 ... 60 Hz		
Courant nominale	230 V / 1,5 A – 110 V / 3 A		
Valeurs de protection	230 V / 2 AT – 110 V / 4 AT		
Conditions d'opération			
Température fonctionnement	5 ... 40 °C		
Max. humidité	80% (sans condensation)		

Panneau de contrôle	
Touches	Impression test, Menu fonction; Quantité, Carte CF, Avance, Enter, 4 x Curseur
Afficheur LCD	Écran 132 x 32 pixel rétroéclairage vert
Réglages	
	Date, Heure, Horaire d'équipe. 11 langues (autres sur demande). Paramètres de la machine, interfaces, mot de passe, variables
Surveillance	
Arrêt d'impression	Fin de ruban transfert / Fin de layout / Tête d'impression ouverte
Impression d'état	Impression des réglages d'imprimante par ex. la longueur totale d'impression, paramètres des cellules. Impression de tous fonts internes et tous codes à barres supportés
Polices	
Types de police	6 polices bitmap 8 polices vectorielles/TrueType 6 polices proportionnelles autres polices sur demande
Set de caractères	Windows 1250 à 1257, DOS 437, 850, 852, 857 Tous les signes d'Europe de l'Ouest et de l'Est, latins, cyrilliques, grecs et arabes (optionnel) sont supportés. Autres sets de caractères sur demande
Polices Bitmap	Taille en largeur et hauteur 0,8 ... 5,6 Facteur d'agrandissement 2 ... 9 Orientation 0°, 90°, 180°, 270°
Polices vectorielles/TrueType	Taille en largeur et hauteur 1 ... 99 mm Facteur d'agrandissement illimité Orientation 0°, 90°, 180°, 270°
Style	selon la police, gras, italique, inverse, verticale
Espace entre caractères	variable
Codes à barres	
1D codes à barres	CODABAR, Code 128, Code 2/5 interleaved, Code 39, Code 39 extended, Code 93, EAN 13, EAN 8, EAN ADD ON, GS1-128, Identcode, ITF 14, Leitcode, Pharmacode, PZN 7 Code, PZN 8 Code, UPC-A, UPC-E
2D codes à barres	Aztec Code, CODABLOCK F, DataMatrix, GS1 DataMatrix, MAXICODE, PDF 417, QR Code
Codes à barres composites	GS1 DataBar Expanded, GS1 DataBar Limited, GS1 DataBar Omnidirectional, GS1 DataBar Stacked, GS1 DataBar Stacked Omnidirectional, GS1 DataBar Truncated
	Tous les codes sont variables en hauteur, élargissement et ratio Orientation 0°, 90°, 180°, 270° Optionnellement avec clé de contrôle et la ligne lisible en clair
Logiciels	
Configuration	ConfigTool
Commande de processus	NiceLabel
Logiciels d'étiquetage	Labelstar Office Lite Labelstar Office
Pilotes Windows	Windows XP® 32/64 Bit, Windows Vista® 32/64 Bit Windows 7® 32/64 Bit, Windows 8® 32/64 Bit Windows 8.1® 32/64 Bit, Windows Server 2003® (R2) 32/64 Bit Windows Server 2008® 32/64 Bit, Windows Server 2008® (R2) 64 Bit Windows Server 2012® 64 Bit, Windows Server 2012® (R2) 64 Bit

Sous réserve de modifications techniques.

Nettoyage et maintenance



DANGER!

Danger de mort par choc électrique!

⇒ Déconnecter le bloc d'impression directe du secteur avant tous travaux de maintenance.

Nettoyer la tête d'impression



REMARQUE!

Il est recommandé de porter un équipement de protection individuelle tel que des lunettes de protection lors du nettoyage de l'appareil.

L'impression peut entraîner une accumulation de poussière sur la tête d'impression, par exemple par des particules de couleur du ruban de transfert, et il est donc nécessaire de nettoyer la tête d'impression à des intervalles réguliers en fonction des heures de fonctionnement, et de l'environnement comme les poussières, etc.



ATTENTION!

La tête d'impression peut être endommagée!

- ⇒ Ne pas utiliser d'objets coupants ou durs pour nettoyer la tête d'impression.
- ⇒ Ne pas toucher la couche de protection en verre de la tête d'impression.

- Enlever la cassette de film transfert.
- Nettoyer la surface de la tête d'impression avec un coton tige ou avec une éponge imbibée d'alcool pur.
- Laisser sécher la tête d'impression 2-3 minutes avant la mise en service du bloc d'impression directe.



REMARQUE!

Veuillez observer les recommandations de manipulation pour l'utilisation d'isopropanol (IPA). En cas de contact avec les yeux ou la peau, rincer abondamment à l'eau courante. En cas d'irritation persistante, consulter un médecin. Assurer une ventilation suffisante.

Echanger la tête d'impression



ATTENTION!

La tête d'impression peut être endommagée par les décharges électrostatiques ou des influences mécaniques!

- ⇒ Placer le bloc d'impression directe sur une conductible surface mise à la terre.
- ⇒ Mettre à la terre le corps, par ex. par attacher une courroie de poignet mise à la terre.
- ⇒ Ne toucher pas les contacts aux connecteurs.
- ⇒ Ne toucher pas le bord d'impression avec des objets durs ou avec la main

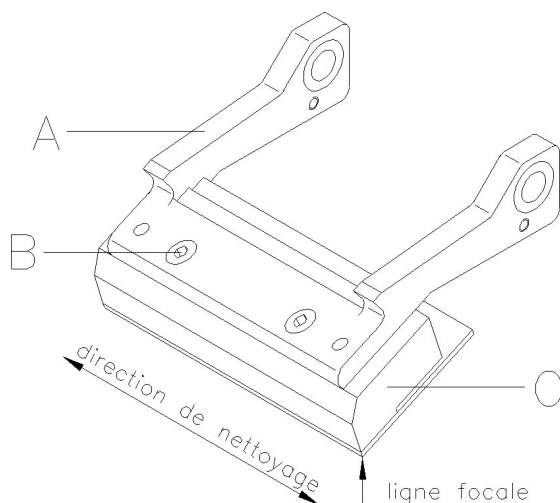

Démonter la tête d'impression

- Enlever la cassette de film transfert.
- Pousser l'unité de tête d'impression dans la position service appropriée.
- Appuyer le support de tête d'impression (A) un peu vers le bas jusqu'à ce qu'on puisse insérer une clé à six pans (2,5) dans les vis (B).
- Enlever les vis (B) et après la tête d'impression (C).
- Enlever le connecteur arrière de la tête d'impression.

Installer la tête d'impression

- Insérer les connecteurs à la nouvelle tête d'impression.
- Positionner la tête d'impression dans le support (A), de sorte que les entraîneurs saisissent dans les perçages correspondants dans le support (A).
- Tenir le support tête d'impression (A) avec le doigt légèrement sur le rouleau de pression et vérifier la position correcte de la tête d'impression (C).
- Serrer la vis (B) avec la clé à six pans et serrer fermement.
- Insérer encore la cassette de film transfert.
- Entrer la valeur de résistance de la nouvelle tête d'impression dans les 'Fonctions service/Résistance dot'. La valeur se trouve dans la plaque signalétique de tête d'impression.
- Vérifier la position de la tête d'impression à l'aide d'une impression de test.

Ajustement d'angle (mode intermittent)

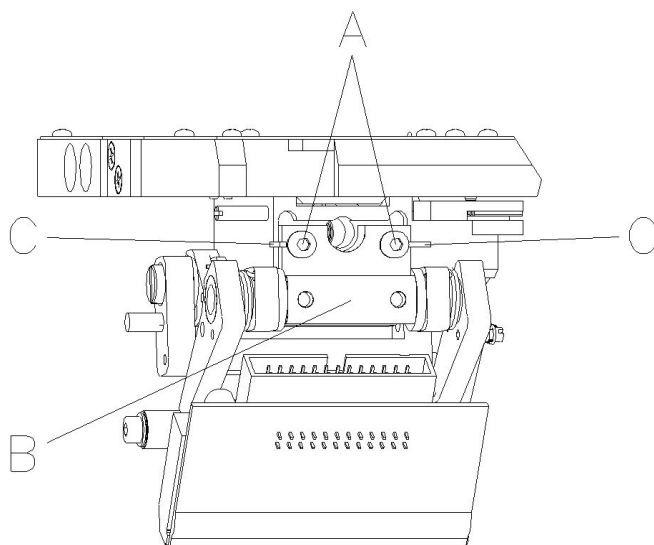

L'angle installation de la tête d'impression est par défaut 26° à la surface d'impression. Tolérances de la fabrication de tête d'impression et de mécanique peuvent résulter en changer l'angle.



ATTENTION!

La tête d'impression peut être endommagée par l'usure inégale!

Plus d'usage de film transfert par déchirage plus rapide.

⇒ Changer l'installation de fabrication seulement en cas d'exception!

- Desserrer légèrement les vis (A).
- Déplacer la pièce de réglage (B), pour changer l'angle entre la tête d'impression et le support.
- Déplacer vers le bas = diminuer l'angle
- Déplacer vers le haut = agrandir l'angle
- Serrer encore les vis (A).
- Démarrer un ordre d'impression (ca. 3 layouts) pour vérifier la course correcte de film transfert.



REMARQUE!

Les échancrures appliquées (C) sont données au contrôle de position. Faire attention sur un réglage parallèle que possible.

Quick reference guide and
product safety

English

Copyright by Carl Valentin GmbH.

Information on the scope of delivery, appearance, performance, dimensions and weight reflect our knowledge at the time of printing.

We reserve the rights to make modifications.

All rights, including those regarding the translation, are reserved.

No part of this document may be reproduced in any form (print, photocopy or any other method) or edited, copied or distributed electronically without written permission from Carl Valentin GmbH.

Due to the constant further development of our devices discrepancies between manual and device can occur.

Please check www.carl-valentin.de for the latest update.

Trademarks

All named brands or trademarks are registered brands or registered trademarks of their respective owners and may not be separately labelled. It must not be concluded from the missing labelling that it is not a registered brand or a registered trademark.

Carl Valentin direct print modules comply with the following safety guidelines:

- CE** EG Machinery Directive (98/37/EC)
- EG Low-Voltage Directive (2006/95/EC)
- EG Electromagnetic Compatibility Directive (89/336/EEC)



Carl Valentin GmbH

Postfach 3744
78026 Villingen-Schwenningen
Neckarstraße 78 – 86 u. 94
78056 Villingen-Schwenningen

Phone +49 (0)7720 9712-0
Fax +49 (0)7720 9712-9901

E-Mail info@carl-valentin.de
Internet www.carl-valentin.de

Contents

Intended use	92
Safety notes	92
Environmentally-friendly disposal	93
Operating conditions	94
Unpack the direct print module	97
Scope of delivery	97
Connecting the direct print module	97
Before initial operation	97
Print control	97
Initiation	97
Loading ribbon cassette	98
Print settings	99
Machine parameters	99
Layout settings	100
Ribbon save (continuous mode)	101
Ribbon save (intermittent mode)	103
Device settings	104
I/O parameters	105
Network	105
Remote console	105
Interface	106
Emulation	106
Date & time	107
Service functions	108
Main menu	110
Compact Flash Card	111
Technical data	113
Cleaning the printhead	115
Replacing the printhead	115
Angle adjustment (intermittent mode)	116

Intended use

- The direct print module is a state-of-the-art device which complies with the recognized safety-related rules and regulations. Despite this, a danger to life and limb of the user or third parties could arise and the direct print module or other property could be damaged while operating the device.
- The direct print module may only be used while in proper working order and for the intended purpose. Users must be safe, aware of potential dangers and must comply with the operating instructions. Faults, in particular those which affect safety, must be remedied immediately.
- The direct print module is solely intended to print suitable media which have been approved by the manufacturer. Any other or additional use is not intended. The manufacturer/supplier is not liable for damage resulting from misuse. Any misuse is at your own risk.
- Intended used includes heeding the operating manual, including the maintenance recommendations/regulations specified by the manufacturer.

Safety notes

- The direct print module is designed for power supply systems from 110-230 V. Connect the direct print module only to electrical outlets with a ground contact.



NOTICE!

When changing the mains voltage the fuse value is to adapt accordingly (see 'Technical Data').

- Couple the direct print module to devices using extra low voltage only.
- Before making or undoing connections, switch off all devices involved (computer, printer, accessories etc.).
- Operate the direct print module in a dry environment only and do not get it wet (sprayed water, mist etc.).
- Do not operate the direct print module in explosive atmosphere and not in proximity of high voltage power lines.
- Operate the direct print module only in an environment protected against abrasive dust, swarf and other similar impurity.
- If the direct print module is operated with the cover open, ensure that clothing, hair, jewellery and similar personal items do not contact the exposed rotating parts.



NOTICE!

With the open printing unit (due to construction) the requirements of EN60950-1 regarding fire protection casing are not fulfilled. These must be ensured by the installation into the end device.

- The print unit can get hot during printing. Do not touch the printhead during operation. Cool down the print unit before changing material, removal or adjustment.
- Carry out only the actions described in these operating instructions. Any work beyond this may only be performed by the manufacturer or upon agreement with the manufacturer.
- Unauthorized interference with electronic modules or their software can cause malfunctions.
- Other unauthorized work or modifications to the direct print module can endanger operational safety.
- Always have service work done in a qualified workshop, where the personnel have the technical knowledge and tools required to do the necessary work.
- There are warning stickers on the direct print modules that draw your attention to dangers. Therefore the warning stickers are not to be removed as then you and others cannot be aware of dangers and may be injured.
- The direct print module must be integrated with the Emergency Stop circuit when it is incorporated into the overall machine.
- All isolating safety equipment must be installed before starting-up the machine.



DANGER!

Danger to life and limb from power supply!

⇒ Do not open the casing.

**NOTICE!**

For Norway and Sweden

Devices which are attached via a power connector with a connection to safety earthing to the safety earthing of the electric equipment of the building and to a cable distribution system with coaxial cables can cause fire risks under certain circumstances. Therefore the connection with a cable distribution system must be made by a device which provides an electric insulation underneath a specific frequency range.

Environmentally-friendly disposal

Manufacturers of B2B equipment are obliged to take back and dispose of old equipment that was manufactured after 13 August 2005. As a principle, this old equipment may not be delivered to communal collecting points. It may only be organised, used and disposed of by the manufacturer. Valentin products accordingly labelled can therefore be returned to Carl Valentin GmbH.

This way, you can be sure your old equipment will be disposed of correctly.

Carl Valentin GmbH thereby fulfils all obligations regarding timely disposal of old equipment and facilitates the smooth reselling of these products. Please understand that we can only take back equipment that is sent free of carriage charges.

Further information on the WEEE directive is available on our website www.carl-valentin.de.

Operating conditions

Before initial operation and during operation these operating conditions have to be observed to guarantee safe and interference-free service of our devices.

Therefore please carefully read these operating conditions.

As the delivery is customised, please compare the supplied accessories with your order.

General conditions

Shipment and storage of our devices are only allowed in original packing.

Installation and initial operation of our direct print modules is only allowed if operating conditions were fulfilled.

Commissioning is prohibited until it can be established that, where relevant, the machine into which the partly completed machinery is to be incorporated complies with the provisions of Machinery Directive 2006/42/EC.

Initial operation, programming, operation, cleaning and service of our direct print modules are only recommended after careful study of our manuals.

Operation of direct print module is only allowed by especially trained persons.



NOTICE!

Organise trainings regularly.

Content of the training are the chapters 'Operating Conditions', 'Loading Media' and 'Maintenance and Cleaning'.

These indications are also valid for someone else's equipment supplied by us.

Only use original spare and exchange parts.

Please contact the manufacturer with respect to spare/wear parts.

Instructions for lithium battery

CPU of direct print module is equipped with a lithium battery (type CR 2032) for which the battery regulation is to apply. This regulation plans that unloaded batteries have to be given to used battery collecting containers of trade and public carries. In case that batteries were not completely discharged you have to make arrangements for short-circuits. At a shutdown of direct print module the battery has to be disposed in either case separately from direct print module.



DANGER!

Danger of life by explosion!

⇒ Use nonconducting tools.

Conditions for installation place

The installation place of direct print module should be even, free of vibration and currents of air are to be avoided.

The direct print module have to be installed to ensure optimal operation and servicing.

Installation of power supply

The installation of the power supply to connect our direct print modules has to be effected according to the international rules and regulations, especially the recommendations of one of the three following commissions:

- International Electronic Commission (IEC)
- European Committee for Electro technical Standardisation (CENELEC)
- Verband Deutscher Elektrotechniker (VDE)

Our devices are constructed according to VDE and have to be connected to a grounded conductor. The power supply has to be equipped with a grounded conductor to eliminate internal interfering voltage.

Technical data of power supply

Power line voltage and power line frequency:	see type plate
Allowable tolerance of power line voltage:	+6% to -10% of nominal value
Allowable tolerance of power line frequency:	+2% to -2% of nominal value
Allowable distortion factor of power line voltage:	<=5%

Anti-Interference measures:

In case your net is infected (e.g. by using thyristor controlled machines) anti-interference measures have to be taken. You can use one of the following possibilities:

- Provide separate power supply to our direct print modules.
- In case of problems please connect capacity-decoupled isolation transformer or similar interference suppressor in front of our direct print modules.

Stray radiation and immunity from disturbance

Emitted interference according to EN 61000-6-4: 08-2002

- Interference voltage to wires according to EN 55022: 09-2003
- Interference field power according to EN 55022: 09-2003
- System perturbation according to EN 61000-3-2: 09-2005
- Flicker according to EN 61000-3-3: 05-2002

Immunity to interference according to EN 61000-6-2: 03-2006

- Stray radiation against discharge of static electricity according to EN 61000-4-2: 12-2001
- Electromagnetic fields according to EN 61000-4-3: 11-2003
- Fast transient burst according to EN 61000-4-4: 07-2005
- Surge according to EN 61000-4-5: 12-2001
- High-frequency tension according to EN 61000-4-6: 12-2001
- Voltage interruption and voltage drop according to EN 61000-4-11: 02-2005



NOTICE!

This is a machine of type A. This machine can cause interferences in residential areas; in this case it can be required from operator to accomplish appropriate measures and be responsible for it.

Sécurité des machines

- EN 415-2 – Sécurité des machines d'emballage
- EN 60204-1:2006 – Sécurité des machines – Équipement électrique de machines – Partie 1

Connecting lines to external machines

All connecting lines have to be guided in shielded lines. Shielding has to be connected on both sides to the corner shell.

It is not allowed to guide lines parallel to power lines. If a parallel guiding cannot be avoided a distance of at least 0.5 m has to be observed.

Temperature of lines between: -15 to +80 °C.

It is only allowed to connect devices which fulfil the request 'Safety Extra Low Voltage' (SELV). These are generally devices which are checked corresponding to EN 60950.

Unpack the direct print module

- ⇒ Lift the direct print module out of the box.
- ⇒ Check the direct print module for transport damages.
- ⇒ Check delivery for completeness.

Scope of delivery

- Print mechanics.
- Control unit.
- Power cable.
- Connection cable (sensors, power).
- Mini controller.
- Manometer.
- Pneumatic tube.
- Push-on connector.
- I/O accessories (female connectors for I/O, I/O 24 cable).
- 1 transfer ribbon roll.
- Empty core, mounted on transfer ribbon rewinder.
- Cleaning foil for printhead.
- Documentation.
- CD with printer drivers.



NOTICE!

Retain original packaging for subsequent transport.

Connecting the direct print module

The direct print module is equipped with a versatile power supply unit. The device may be operated with a mains voltage of 110-230 V / 50-60 Hz without any adjustments or modifications.



CAUTION!

The direct print module can be damaged by undefined switch-on currents.

- ⇒ Set de power switch to '0' before plugging in the direct print module.
- ⇒ Insert power cable into power connection socket.
- ⇒ Insert plug of power cable into a grounded electrical outlet.



NOTICE!

Insufficient or missing grounding can cause faults during operation.

Ensure that all computers and connection cables connected to the direct print module are grounded.

- ⇒ Connect direct print module to computer or network with a suitable cable.

Before initial operation

- ⇒ Mount print mechanics.
- ⇒ Connect all cables between print mechanics and control unit.
- ⇒ Protect cables against unintentional unscrewing.
- ⇒ Connect compressed air line.
- ⇒ Connect control unit and PC by printer interface.
- ⇒ Connect control unit and packaging machine by inputs and outputs.
- ⇒ Connect power cable of control unit.

Print control

Because of the fact that the print module is always in control mode it is only possible to transmit and not to start print orders by the available interfaces (serial, parallel, USB or Ethernet). The print is started by a start signal to the 'print start-control input'. It is necessary for the control unit to recognise the moment of setting the start signal and therefore it is possible and also necessary to observe the print status by the outputs.

Initiation

Once all connections have been made:

- ⇒ Switch control unit on with the power switch. After switching on the device the main menu appears which shows the model type, current date and time.
- ⇒ Insert ribbon cassette. After loading the transfer ribbon cassette the measuring of transfer ribbon begins and the printhead is moved to the print position.

Loading Ribbon Cassette



NOTICE!

As for the electrostatic unloading the thin coating of the thermal printhead or other electronic parts can be damaged, the transfer ribbon should be antistatic. The use of wrong materials can lead to printer malfunctions and the guarantee can expire.

Ribbon Coating Outside



NOTICE!

Before a new transfer ribbon roll is loaded, the printhead must be cleaned using printhead and roller cleaner (97.20.002).

The handling instructions for the use of Isopropanol (IPA) must be observed. In the case of skin or eye contact, immediately wash off the fluid thoroughly with running water. If the irritation persists, consult a doctor. Ensure good ventilation.

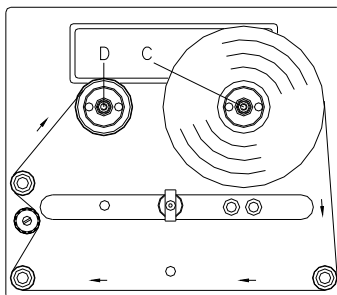
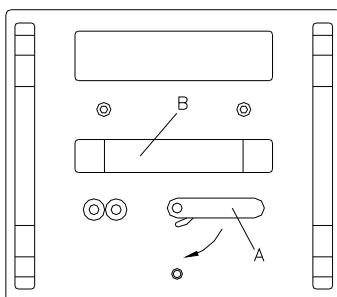

The illustration shows a left hand printing system. If you are using a right hand system, then the new roll is to be inserted at the left and the cardboard core is to be inserted at the right side.

- Turn lever (A) 90° in clockwise direction.
- Remove ribbon cassette from print mechanics by pulling handle (B).
- Load a new ribbon roll as far as it will go onto unwinding roll (C).
- Load an empty cardboard roll as far as it will go onto rewinding unit (D).
- Insert ribbon according to illustration.
- Fix ribbon with an adhesive tape at the empty roll and tighten it by some turns of the core.
- Push ribbon cassette again onto print mechanics and take care that the ribbon not rip.
- Turn lever (A) 90° anticlockwise.

Ribbon Coating Inside

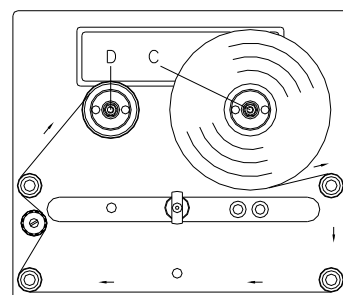
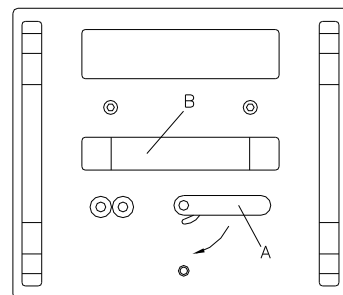

The illustration shows a left hand printing system. If you are using a right hand system, then the new roll is to be inserted at the left and the cardboard core is to be inserted at the right side.

- Turn lever (A) 90° in clockwise direction.
- Remove ribbon cassette from print mechanics by pulling handle (B).
- Load a new ribbon roll as far as it will go onto unwinding roll (C).
- Load an empty cardboard roll as far as it will go onto rewinding unit (D).
- Insert ribbon according to illustration.
- Fix ribbon with an adhesive tape at the empty roll and tighten it by some turns of the core.
- Push ribbon cassette again onto print mechanics and take care that the ribbon not rip.
- Turn lever (A) 90° anticlockwise.

Print settings

Keys: **F**

Function Menu
Print Settings

Key:

Continuous mode

Contrast
(in %): 100

Contrast:

Value range: 10% ... 200 %.

Intermittent mode

Speed: 100
Contrast: 100

Speed:

Value range: 50 mm/s ... 200 mm/s.

Contrast:

Value range: 10% ... 200 %.

Key:

Ribbon Control
ON strong sens.

Ribbon control:

Examination if the transfer ribbon roll is to end or if the ribbon was torn at the unwinding roll.
Off: The ribbon control is deselected, i.e. the direct print module continues without an error message.

On: The ribbon control is selected, i.e. the current print order is interrupted and an Error Message appears at the display.

strong sensibility: The direct print module reacts immediately to the end of the transfer ribbon.

weak sensibility: The direct print module reacts at approx. 1/3 more slowly to the end of the transfer ribbon.

Key:

X Displacement
Offs (mm): -1.5

X displacement:

Indication of displacement in X direction. The fields on the layout are moved.

Value range: -90.0 to +90.0.

Machine parameters

Continuous mode

Keys: **F**,

Function Menu
Machine Param.

Key:

Mode
IO DY

Mode:

Selection of operating mode.

Key:

Print Offset
(mm) 10.0

Print Offset:

Distance of the layout to the zero point of machine.

Value range: 1 ... 999 mm

Key:

Print position
(mm) 20.0

Print position:

Start position of print carriage in mm.

Value range: 12 ... 93 mm

Key:

Layouts/cycle
1

Layouts/cycle:

Indication of number of printed layouts per print start (cycle).

Value range: 1 ... 25 layouts per cycle.

Intermittent mode

Keys: **F**,

Function Menu
Machine Param.

Key:

Mode
2 continuous

Mode:

Selection of operating mode.

Key:

Back-Speed mm/s
400

Back-Speed: Indication of back speed of the print mechanics after print end in mm/s.

Value range: 50 ... 600 mm/s.

Key:

Print Offset
(mm) 10.0

Print Offset:

Distance of the layout to the zero point of machine.

Value range: 1 ... 999 mm

Key:

Print position
(mm) 20.0

Print position:

Start position of print carriage in mm.

Value range: 12 ... 93 mm

Continuous mode

Key:

ChkSpeed On Strt
Off

Check material speed at print start signal:
Verification of material speed at print start signal.

Key:

Res. mm/360°
2000 166

Encoder resolution / material feed per encoder rotation:
indicates resolution of used encoder and material feed per rotation of encoder in mm.

Key:

Material speed
200 mm/s

Material speed:
Indication of material speed (only for reading purposes).

Intermittent mode

Key:

Layouts/cycle
1

Layouts/cycle:
Indication of number of printed layouts per print start (cycle).
Value range: 1 ... 25 layouts per cycle.

Layout settings

Keys: **F**, ,

Function menu
Layout settings

Key:

Printlength (mm)
100.0

Printlength: Indication of way which the print mechanics has to move. The print length depends on the length of the print mechanics.

Key:

Width: 20.0
Columns: 4

Column printing:
Indication of width of one layout as well as how many layouts are placed side by side.

Key:

Material
Type 2

Material: Selection of the used print materials.

Key:

Flip layout
Off

Flip layout:
The axis of reflection is in the middle of the layout. If the layout width was not transferred to the print module, automatically the default layout width i.e. the width of the printhead is used. It is recommended to use layouts with the same width as the printhead. Otherwise this can cause problems in positioning.

Key:

Rotate layout
On

Rotate layout:
According to standard the layout is printed ahead with a rotation of 0°. If the function is activated, the layout is rotated by 180° and printed in reading direction.

Key:

Alignment
Left

Alignment:
The adjustment of layout is effected only after 'flip/rotate layout', i.e. the adjustment is independent of the functions flip and rotate.
Left: The layout is aligned at the left-most position of printhead.
Centre: The layout is aligned at central point of printhead.
Right: The layout is aligned at right-most position of printhead.

Ribbon save (continuous mode)

Keys: **F**, , , 

Function menu
Ribbon save

Key: 

Mode Speed
Standard 600

Mode:

Selection of ribbon save mode.

Off: Ribbon save set to Off.

Standard: Maximum ribbon save performance

SaveStrt: No start signal loss

Speed: Determination of max. print speed.

Mode: Standard

R-Correction
-1 mm

Rewind correction:

0 mm = It is always so far retreated that an optimal ribbon save is reached.

Default: 0 mm

-xx mm = The retreat can be made smaller.

+xx mm = The retreat can be made larger.

Key: 

sa/mm cmin so/mm
303 1000 10

Performance information:

sa/mm: The smallest possible distance of two prints with full ribbon save

cmin: Max. number of cycles per minute.

so/mm: Indicates the loss of ribbon save

Key: 

ExpertParameters

ExpertParameters (password protected):

Enter password, press key  to confirm the entry and the following parameters are indicated:

Key: 

PhDownT REStartT
30 ms 10 ms

PhDownT = printhead down time in ms:

Is used from ribbon save algorithm to use for the calculation of start time of printhead upward movement.

REStartT = ribbon motor early start time in ms:

This value is added to the increase time of transfer ribbon movement.

Key: 

MinSpeed Calcoff
50 mm/s On

MinSpeed = minimal print speed:

If the min. print speed is increased, the max. number of cycles is also increased.

Calcoff = Turn On/Off print offset border calculation:

If this parameter is set to Off, then a smaller as the required print offset can be entered.

Key: 

PhUpT PhVReactT
20 ms 10 ms

PHUpT = printhead up time in ms:

Is used from ribbon save algorithm to calculate if a field ribbon save can be made or not.

PhVReactT = valve reaction time in ms:

The time is calculated when to start with printhead upward movement.

Key: 

RibMotStpDlayT
2 ms

RibMotStpDlayT = ribbon motor stop delay time

Deceleration time in ms in which the transfer ribbon motor is still moved with constant speed before stopping.

Key: 

FieldRS Rwind v
Normal 600mm/s

FieldRS = field ribbon saving:

Off: Field ribbon save switched off.

Normal: Field ribbon save is only accomplished if the transfer ribbon motor can be completely stopped.

PHOnly: Only the printhead is moved. The transfer ribbon does not stop.

Strong: Field ribbon save is even accomplished if the transfer ribbon motor cannot be stopped.

Rwind v = rewind speed in mm/s:

Indication of rewind in mm/s.

Key: 

Speed 1. Field
400 mm/s

Speed 1. Field:

If 0 (default value) is set, the parameter has no influence to the ribbon save.

Key: 

Tension
0 mm

Tension:

Indication of length, which is transported forward after measuring the transfer ribbon.

Mode: Shift

X-Shift Y-Shift
10 mm 13 mm

X-Shift and Y-Shift:

X-Shift: Indication of displacement of the printout in X direction.

Y-Shift: Indication of displacement of the printout in printing direction.

Key: 

Lanes R-Shift
3 -5 mm

Lanes / R-Shift:

Lanes: Indication of number of lanes printed side by side.

R-Shift: Indication of distance when changing to a new lane.

Key: 

ExpertParameters

ExpertParameters (password protected):

Enter password and press key  to confirm the entry.

See mode 'Standard' for description of the parameters.

Mode: SaveStrt

ExpertParameters

ExpertParameters (password protected):

Enter password and press key  to confirm the entry.

See mode 'Standard' for description of the parameters.

Ribbon save (intermittent mode)

Keys: **F**, , , 

Function menu
Ribbon save

Key: 

Mode
Standard

Mode:

Selection of ribbon save mode.

Off: Ribbon save set to Off.

Standard: Maximum ribbon save performance.

Shift: Maximum utilization of transfer ribbon.

Mode: Standard

R-Correction
-1 mm

Rewind correction:

0 mm = It is always so far retreated that an optimal ribbon save is reached.

Default: 0 mm

-xx mm = The retreat can be made smaller.

+xx mm = The retreat can be made larger.

Key: 

ExpertParameters

ExpertParameters (password protected):

Enter password, press key  to confirm the entry and the following parameters are indicated:

Key: 

PhDownT PhUpT
35 ms 0 ms

PhDownT = printhead down time in ms:

Is used from ribbon save algorithm to use for the calculation of start time of printhead upward movement.

PhUpT = printhead up time in ms:

Is used from ribbon save algorithm to calculate if a field ribbon save can be made or not.

Key: 

PhVReactT
10 ms

PhVReactT = valve reaction time in ms:

The time is calculated when to start with printhead upward movement.

Key: 

Tension RM
0 mm 0

Tension / Ribbon Mode:

Tension: Indication of length that is transported forwards after measuring the transfer ribbon.

Ribbon Mode:

0: The transfer ribbon is retracted after each printout over the complete print length, i.e. no ribbon save between the individual layouts.

1: The transfer ribbon is only retracted over the printed sector, i.e. the gaps between the layouts were not optimised.

When changing the layouts, the transfer ribbon is positioned automatically

Mode: Shift

X-Shift Y-Shift
10 mm 13 mm

X-Shift and Y-Shift:

X-Shift: Indication of displacement of the printout in X direction.

Y-Shift: Indication of displacement of the printout in printing direction.

Key: 

Lanes R-Shift
3 -5 mm

Lanes / R-Shift:

Lanes: Indication of number of lanes printed side by side.

R-Shift: Indication of distance when changing to a new lane.

Key: 

ExpertParameters

ExpertParameters (password protected):

Enter password and press key  to confirm the entry.

See mode 'Standard' for description of the parameters.

Device settings

Keys: **F**, , , , 

Function Menu
Device Settings

Key: 

Field Handling
OFF

Field handling:

Off: The complete print memory is deleted.

Keep graphic: A graphic res. a TrueType font is transferred to the direct print module once and stored in the direct print module internal memory. For the following print order only the modified data is transferred to the direct print module. The advantage is the saving of transmitting time for the graphic data.

The graphic data created by the direct print module itself (internal fonts, bar codes, ...) is generated only if they were changed. The generating time is saved.

Delete graphic: The graphics res. TrueType fonts stored in the internal memory is deleted but the other fields are kept.

Key: 

Codepage
GEM German

Codepage:

Indication of the font used in the direct print module.

Key: 

ext. Parameters
ON

External parameters:

Layout dimension only: The parameters for layout length, gap length and layout width can be transferred to the printing system. All other parameter settings are to be made directly at the printing system.

On: Sending parameters such as print speed and contrast via our layout creation software to the direct print module. Parameters which are set directly at the direct print module before are no longer considered.

Off: Only settings made directly at the direct prin module are considered.

Key: 

Buzzer
On

Buzzer:

An acoustic signal is audible when pressing a key.

Value range: 1 ... 7.

Off: No signal is audible.

Key: 

Language
English

Language:

Selection of language in which you want to display the text in the display of control unit.

At the moment the following languages are available: German, English, French, Spanish, Portuguese, Dutch, Italian, Danish, Finnish, Polish, Czech and Russian.

Key: 

Customized Entry
On

Customized entry

On: The question referring the customized variable appears once before the print start at the display.

Auto: The question referring the customized variable appears after every printed layout.

Off: No question appears at the display. In this case the stored default value is printed.

Key: 

Hotstart
Off

Hotstart:

On: Continue an interrupted print order after switching on the module anew.

(Only if module is equipped with option Compact Flash card)

Off: After switching off the direct print module the complete data is lost.

Key: 

Password Prot.
Active

Password:

By a password several functions can be blocked, so the user cannot work with them.

Key: 

Layout confirm.
On

Layout confirmation:

On: A new print order is only printed after confirmation at the device.

An already active continuing print order is printed as long as the confirmation is effected at the device.

Off: No query appears at the display of control unit.

Key: 

Standard layout
Off

Standard layout:

On: If a print order is started without previous definition of layout, the standard layout (device type, firmware version, build version) is printed.

Off: If a print order is started without previous definition of layout, an error message appears in the display.

I/O parameters

Keys: **F**, , , , , 

Function Menu
I/O Parameter

Key: 

IN signal level
1s2x3+4x5x6x7x8x

IN signal level:

Indication of signal at which a print order is started.

+ = active signal level is 'high' (1)

- = active signal level is 'low' (0)

x = not activated signal level

s = status can be affected by interface (in combination with Netstar PLUS)

Key: 

OUT signal level
1+2+3+4+5+6+7+8+

OUT signal level:

Indication of signal level for output signal.

+ = active signal level is 'high' (1)

- = active signal level is 'low' (0)

s = status can be affected by interface (in combination with Netstar PLUS)

Key: 

Debouncing (ms)
50

Debounce

Indication of debounce time of the dispenser input.

Value range: 0 ... 100 ms.

Key: 

Start delay (s)
1.00

Start signal delay:

Indication in time per second of the delay for the start signal.

Value range: 0.00 ... 9.99.

Key: 

ErrorIfNotReady
On

Error if not ready:

On: If a print order is active but the direct print module is not ready to process the order (e.g. if it is already in 'printing' mode), then an error message appears.

Off: No error message appears.

Key: 

ReadyWhilePrint
Off

Ready while printing:

Indication if the output signal 'print ready' (Out 5, Output II) remains active while printing.

Off: At print start the 'print ready' signal is inactive (default setting).

On: At print start the 'print ready' signal remains active.

Network

Keys: **F**, , , , , , 

Function Menu
Network

For more information, please see the separate manual.

Remote console

Keys: **F**, , , , , , 

Function Menu
Remote Console

For more information please contact our sales department.

Interface

Keys: **F**, , , , , , , , 

Function Menu
Interface

Key: 

COM1	Baud	P	D	S
0	9600	N	8	2

COM1:

0 - serial interface Off.
1 - serial interface On.
2 - serial Interface On, no error message occurs in case of a transmission error.

Baud rate:

Indication of bits which are transferred per second.
Following values are possible: 1200, 2400, 4800, 9600, 19200, 38400 and 115200.

P = Parity:

N - No parity; E - Even; O - Odd

Please observe that the settings correspond to those of the direct print module.

D = Data bits

Setting of data bits.
Value range: 7 or 8 Bits.

S = Stop bits

Indication of stop bits between bytes.
Value range: 1 or 2 stop bits.

Key: 

Start (SOH):	01
End (ETB):	17

Start/stop sign:

SOH: Start of data transfer block → Hex format 01

ETB: End of data transfer block → Hex format 17

Key: 

Data Memory
Advanced

Data memory

Standard: After starting a print order the direct print module buffer receives data as long as it is filled.

Advanced: During a current print order data is received and processed.



Off: After starting a print order no more data is received.

Key: 

Port test Off

Port test:

Check whether the data are transferred via the interface.

Press the  and  keys to select standard (on). Press the  key and the data sent via any port (COM1, LPT, USB, TCP/IP) is printed.

Emulation

Keys: **F**, , , , , , , , 

Function menu
Emulation



Key: 

Protocol
ZPL

Protocol:

CVPL: Carl Valentin Programming Language

ZPL: Zebra® Programming Language

Press keys  and  to select the protocol. Press key  to confirm the selection. The printer is restarted and ZPL II® commands are transformed internally into CVPL commands.

Key: 

Head Resolution
11.8 (Dot/mm)

Printhead resolution:

At activated ZPL II® emulation the printhead resolution of the emulated printer must be set.

Key: 

Drive mapping
B:->A: R:->R:

Drive mapping:

The access to Zebra® drives is rerouted to the corresponding Valentin drives.

Date & time





Keys: **F**, , , , , , , , , , 

Function menu
Date/Time

Key: 

Date 17.11.04
Time 13:28:06

Set date and time:

The upper line of display shows the current date, the second line the current time. With keys  and  you can change to the next or previous field. With keys  and  you can increase and/or decrease the displayed values.

Key: 

Summertime
On

Summertime:

On: Module automatically adjust clock for daylight saving changes.
Off: Summertime is not automatically recognized and adjusted.

Key: 

ST start format
WW/WD/MM

Start of summertime (format):

Select the format in which you want to define beginning summertime. DD = day, WW = week, WD = weekday, MM = month, YY = year, next day = only next day is taken into consideration

Key: 

WW WD MM
last sunday 03

Start of summertime (date):

By means of this function you can enter the date at which summertime has to start. This entry refers to the previously selected format. Example: summertime is automatically adjusted at last Sunday in March (03).

Key: 

ST start time
02:00

Start of summertime (time):

By means of this function you can define the time when you want to start summertime

Key: 

ST end format
WW/WD/MM

End of summertime (format):

Select the format in which you want to define end of summertime.

Key: 

WW WD MM
last sunday 10

End of summertime (date):

By means of this function you can define the date when you want to stop summertime. The entry refers to the previously selected format. Example: summertime is automatically adjusted at last Sunday in October (10).

Key: 

ST end time
03:00

End of summertime (time):

By means of this function you can define the time when you want to stop summertime.

Key: 

Time shifting
01:00

Time shifting:

By means of this function you can enter time shifting in hours and minutes (for automatically adjustment from summer and wintertime). This entry refers to the currently set module time.

Service functions



NOTICE!

So that the distributor res. the manufacturer in case of service can offer fast support the necessary information such as selected parameters can be taken directly from the service functions menu of the device.

Keys: **F**, , , , , , , , , , , 

Function Menu
Service Function

Key: 

H P R1 R2 C ENC
0 1 1 0 0 0

Photocell parameters:

H = cover switch (0 = open cover; 1 = closed cover).

P = compressed air control

Value range: 0 or 1.

R1 = transfer ribbon rewinding roll

Indication of transfer ribbon rewinding roll status.

4 states are indicated (no marking in photocell, marking from right, marking from left, marking completely in photocell).

R2 = transfer ribbon unwinding roll

Indication of transfer ribbon unwinding roll status.

4 states are indicated (no marking in photocell, marking from right, marking from left, marking completely in photocell).

C = Carriage: Indication of print carriage position.

ENC = Encoder: Indication of current state of encoder

Key: 

Paper Counter
D000007 G000017

Paper counter:

D: Indication of printhead attainment in meters.

G: Indication of module attainment in meters.

Key: 

Heater Resist.
1250

Heater resistance:

To achieve a high print quality, the indicated Ohm value must be set after an exchange of printhead.

Key: 

Printhead Temp.
23

Printhead temperature:

Indication of printhead temperature. The printhead temperature corresponds normally to the room temperature. In case the maximum printhead temperature is exceeded, the current print order is interrupted and an error message appears at the modules display.

Key: 

Ribbon Ink Side
600 m Out

Ribbon / Ink side:

Ribbon: Selection of the used transfer ribbon length (300 m, 450 m, 600 m, 900 m, 1000 m). With smaller ribbons, a higher number of cycles can be reached.

Ink side:

Selection of the coating side of transfer ribbon, either outside or inside.

Default: Coating outside

Key: 

BrkPow BrkPowP
100 % 100 %

BrkPow:

Adjustment of brake power for acceleration and braking in %.

BrkPowP:

Adjustment of brake power during printing.

Key: 

Print Examples
Settings

Print examples:

Settings: Printout of all settings such as speed, and transfer ribbon material.

Bar codes: Printout of all available bar code types.

Fonts: Printout of all available font types.

Key: 

Input: 1111111
Output: 0000000

Input/Output:

Indication of signal level which indicates the signal a print order is started.

0 – Low

1 – High

Key: 

Diagnostic
Enter

Diagnostic:

Press key  to access the diagnostic menu.

Key: 

EncProf NoOfProf
Off 10

Encoder Profiling:

The encoder values with print start in logging files are registered on CF card. By means of this data, a graphic chart of the encoder curve can be created.

Key: 

DiaRU DiaRW
68mm 655mm

Transfer ribbon roll diameter:

DiaRW = Diameter of transfer ribbon rewinding roll.

DiaRU = Diameter of transfer ribbon unwinding roll.

Key: 

Enc. Average
100

Encoder average:

Number of values by which the encoder signals is averaged.

Key: 

IgnrStrt IntPrts
123 456

Diagnostic - Counter:

Relevant results are counted and registered in RAM memory. The protocols get lost after switching off the device.

IgnrStrt = Counter for ignored start signals.

IntPrts = Counter for cancelled print orders.

Select with the cursor the value for which you need more information and then press key .

Key: 

Njb Nrd Prt
+000 +999 +999

NJb = No job

Counter for ignored start signals because the print order was not active.

NRd = Not ready

Counter for ignored start signals because the print order was not ready (stopped or error message).

Prt = Printing

Counter for ignored start signals, during the device prints/is active.

Key: 

MS/I ItfI SpdS
+000 +999 +999

MS/I = Manual stopped/interrupted

Stop key onto foil keyboard, panel or in a program was pressed.

ItfI = Interface interrupted

The print order was cancelled because new data was received by an interface.

SpdS = Speed stopped

The print order was cancelled because the measured print speed was too slow.

Key: 

On/Offline
Aus

Online/Offline:

This function is activated e.g. if the transfer ribbon is to be changed. It is avoided that a print order is processed although the module is not ready. If the function is activated then press the key  to change between Online and Offline mode. The respective state is indicated in the display.
Standard: Off

Online: Data can be received by interface. The keys of the foil keyboard are only active, if you changed in the Offline mode with key .

Offline: The keys of the foil keyboard are still active but received data are not processed. If the module is again in Online mode then new print orders can be again received.

Key: 

TR advance warn.
On ø: 40 v: 100

TRB = Transfer ribbon advance warning:

Before the end of transfer ribbon, a signal is send by the control output.

Warning diameter:

Setting of transfer ribbon advance warning diameter.

In case you enter a value in mm then a signal appears via control output when reaching this diameter (measured at transfer ribbon roll).

v = Reduced print speed:

Setting of the reduced print speed. This can be set in the limits of the normal print speed.

Additionally there are the following settings:

-: No reduced print speed

0: Printer stops at reaching the warning diameter and indicates 'ribbon error'.

Main menu

After switching on the direct print module, the display shows the following:



* DC c107-12K * 14/09/05 10:16	First line = main menu. Second line = current date and time.
Key: <input type="radio"/>	
* DC c107-12K * V1.44	Second line = version number of firmware.
Key: <input type="radio"/>	
* DC c107-12K * Build 0201	Second line = build version number of software.
Key: <input type="radio"/>	
* DC c107-12K * Jun 2 2005	Second line = creation date of firmware version.
Key: <input type="radio"/>	
* DC c107-12K * 10:37:34	Second line = creation time of firmware version.
Key: <input type="radio"/>	
* DC c107-12K * B-Font: v5.01	Second line = font version of bitmap fonts.
Key: <input type="radio"/>	
* DC c107-12K * V-Font: V1.01	Second line = font version of vector fonts.
Key: <input type="radio"/>	
* DC c107-12K * FPGA V1.4.0 T9	Second line = version number of FPGA.
Key: <input type="radio"/>	
* DC c107-12K * 16 MB Memory	Second line = storage capacity of device in MB.
Key: <input type="radio"/>	
* DC c107-12K * 8 MB FLASH	Second line = memory size of FLASHs in MB.
Key: <input type="radio"/>	
* DC c107-12K * A0 MO V.1.3.1 AB	Second line = version number for first processor (motor control).
Key: <input type="radio"/>	
* DC c107-12K * A1 MO V.1.3.1 AB	Second line = version number for second processor (motor control).
Key: <input type="radio"/>	
* DC c107-12K * A2 IO V.1.3.1 AB	Second line = version number for third processor (I/O control).

Compact Flash Card

Selecting layout

Keys: 

```
→layout01 0
A:\STANDARD
```

Press keys  and  to select the desired label in STANDARD directory.
Press key  to select the layout.

```
Start print
No.layout: 12345
```

Select the number of layouts which you want to print.
Press key  to start the print order.

Loading file from Compact Flash card



Keys: , 

```
CF Functions
Load file
```

Key: 

```
□→ .. <
A:\STANDARD
```

Select the file you want to load and then confirm your selection with .

Press key  and enter the desired number you want to print. Confirm the selection with  and the print order is started by an external signal (Input 1, PIN 1 and PIN 4).

Saving layout onto Compact Flash card

Keys: , , 

```
CF Functions
Save layout
```

Key: 

```
File exists
Overwrite?
```

Select the directory and layout you want to save and then confirm your selection with .

Confirm the above query with  and the layout is saved.

Saving the configuration

Keys: , , , 

```
CF Functions
Save config
```

As standard, the proposed file name is config.cfg. This name can be changed by the user. In this file the parameters of print module are saved which are not saved permanent in the internal Flash.

Press key  to start the saving procedure.

Changing the directory

Keys: , , , , 

```
CF Functions
Change directory
```

Key: 

```
←<.> M
A:\STANDARD\
```





The lower line of display shows the directory which is selected at the moment.

Press keys  and  to change the directory in the upper line.

Press keys  and  to show all available directories.

Press key  to confirm the selected directory.

Delete file from Compact Flash card

Keys: , , , , , 

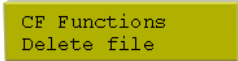

Select the directory res. the layout you want to delete and then confirm your selection with .

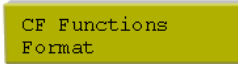

Format Compact Flash card

Keys: , , , , , , 











Key: 



With the  key, select the drive you want to format and then confirm your selection with . While formatting the card, the STANDARD directory is created automatically.

Indication of free memory space

Keys: , , , , , , , 

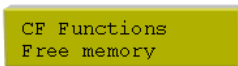

This function indicates free storage capacity that is still available onto the card.

Technical data

	Dynacode 53	Dynacode 107	Dynacode 128
Print resolution	300 dpi	300 dpi	300 dpi
Print speed			
Continuous mode	50 ... 800 mm/s	50 ... 600 mm/s	50 ... 450 mm/s
Intermittent mode	50 ... 600 mm/s	50 ... 600 mm/s	50 ... 600 mm/s
Back speed	intermittent mode only: max. 600 mm/s		
Print width	53,3 mm	106,6 mm	128 mm
Max. print length			
Continuous mode	6000 mm	3000 mm	3000 mm
Intermittent mode	75 mm	75 mm	75 mm
Frame passage width	customized	customized	customized
Printhead	Corner Type	Corner Type	Corner Type
Acoustic emission (measuring distance 1 m)			
Average sound pressure level	60 dB(A)	65 dB(A)	68 dB(A)
Transfer ribbon			
Ink	outside or inside (option)	outside or inside (option)	outside or inside (option)
Max. roll diameter	98 mm	82 mm	75 mm
Core diameter	25.4 mm / 1"	25.4 mm / 1"	25.4 mm / 1"
Max. length	900 m	600 m	450 m
Max. width	55 mm	110 mm	130 mm
Dimensions (width x height x depth)			
Print mechanics			
without mounting frame	204 x 180 x 234 mm	204 x 180 x 290 mm	204 x 180 x 312 mm
with mounting frame	depending on passage width		
Control unit	240 x 125 x 332 mm connecting cable set to mechanics 2.5 m		
Weight			
Print mechanics	9.5 kg	11 kg	11.7 kg
Electronics with cable	5.5 kg	5.5 kg	5.5 kg
Electronics			
Processor	High Speed 32 Bit		
RAM	16 MB / 64 MB (on demand)		
Slot	Compact Flash card type I		
Battery Battery cache	for Real-Time clock (storage of data with shut-down)		
Warning signal	accoustic signal when error		
Interfaces			
Serial	RS-232C (up to 115.200 Baud)		
Parallel	Centronics		
Ethernet	10/100 Base T		
USB	1.1		
Connection values			
Pneumatic connection	min. 6 bar dry and free from oil		
Nominal voltage	110 ... 230 V / 50 ... 60 Hz		
Nominal current	230 V / 1,5 A – 110 V / 3 A		
Fuse values	230 V / 2 AT – 110 V / 4 AT		
Operation data			
Temperature	5 ... 40 °C		
Humidity	max. 80% (non-condensing)		

Operation panel	
Keys	Test print, function menu, quantity, CF Card, feed, enter, 4 x cursor
LCD display	Graphic display 132 x 32 Pixel green backlight
Settings	
	date, time, shift times 11 language settings (others on demand) print and device parameters, interfaces, password protection
Monitoring	
Stop printing if	end of ribbon / printhead open
Status report	extensive status print with information about settings e.g. print length counter, runtime counter, photocell interface and network parameters printout of all internal fonts and all supported bar codes
Fonts	
Font types	6 Bitmap fonts, 8 Vector fonts/TrueType fonts, 6 proportional fonts other fonts on demand
Character sets	Windows 1250 up to 1257, DOS 437, 850, 852, 857 all West and East European Latin, Cyrillic, Greek and Arabic (option) characters are supported other character sets on demand
Bitmap fonts	size in width and height 0,8 ... 5,6 zoom 2 ... 9 orientation 0°, 90°, 180°, 270°
Vektor fonts/TrueType fonts	size in width and height 1 ... 99 mm variable zoom orientation 0°, 90°, 180°, 270°
Font attributes	depending on character font bold, Italic, inverse, vertical
Font width	variable
Bar codes	
1D bar codes	CODABAR, Code 128, Code 2/5 interleaved, Code 39, Code 39 extended, Code 93, EAN 13, EAN 8, EAN ADD ON, GS1-128, Identcode, ITF 14, Leitcode, Pharmacode, PZN 7 Code, PZN 8 Code, UPC-A, UPC-E
2D bar codes	Aztec Code, CODABLOCK F, DataMatrix, GS1 DataMatrix, MAXICODE, PDF 417, QR Code
Composite bar codes	GS1 DataBar Expanded, GS1 DataBar Limited, GS1 DataBar Omnidirectional, GS1 DataBar Stacked, GS1 DataBar Stacked Omnidirectional, GS1 DataBar Truncated
	all bar codes are variable in height, module width and ratio orientation 0°, 90°, 180°, 270°. optionally with check digit and human readable line
Software	
Configuration	ConfigTool
Process control	NiceLabel
Design software	Labelstar Office Lite Labelstar Office
Windows printer driver	Windows XP® 32/64 Bit, Windows Vista® 32/64 Bit Windows 7® 32/64 Bit, Windows 8® 32/64 Bit Windows 8.1® 32/64 Bit, Windows Server 2003® (R2) 32/64 Bit Windows Server 2008® 32/64 Bit, Windows Server 2008® (R2) 64 Bit Windows Server 2012® 64 Bit, Windows Server 2012® (R2) 64 Bit

Technical details are subject to change.

Cleaning and maintenance



DANGER!

Risk of death by electric shock!

⇒ Disconnect the direct print module from power supply before performing any maintenance work.

Cleaning the printhead



NOTICE!

When cleaning the label printer, personal protective equipment such as safety goggles and gloves are recommended.

Printing can cause accumulation of dirt at printhead e.g. by colour particles of transfer ribbon, and therefore it is necessary to clean the printhead in regular periods depending on operating hours, environmental effects such as dust etc.



CAUTION!

Printhead can be damaged!

- ⇒ Do not use sharp or hard objects to clean the printhead.
- ⇒ Do not touch protective glass layer of the printhead.

- Remove transfer ribbon cassette.
- Clean printhead surface with special cleaning pen or a cotton swab dipped in pure alcohol.
- Allow printhead to dry for 2-3 minutes before commissioning the device.



NOTICE!

The handling instructions for the use of Isopropanol (IPA) must be observed. In the case of skin or eye contact, immediately wash off the fluid thoroughly with running water. If the irritation persists, consult a doctor. Ensure good ventilation.

Replacing the printhead



CAUTION!

The printhead can be damaged by static electricity discharges and impacts!

- ⇒ Set up direct print module on a grounded, conductive surface.
- ⇒ Ground your body, e.g. by wearing a grounded wristband.
- ⇒ Do not touch contacts on the plug connections.
- ⇒ Do not touch printing line with hard objects or your hands.

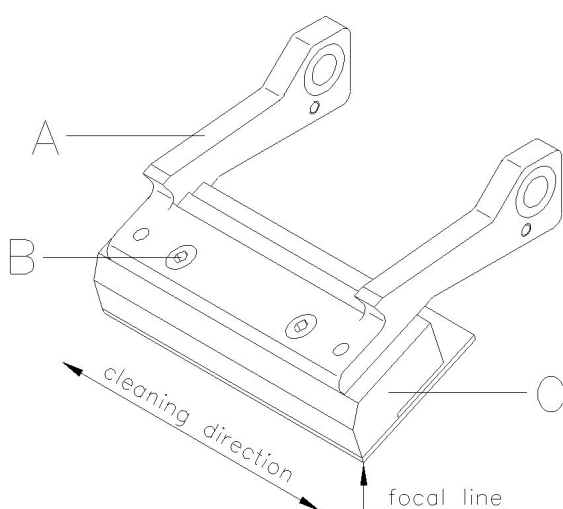

Removing the printhead

- Remove ribbon cassette.
- Move printhead unit in an appropriate service position.
- Press printhead support (A) slightly downwards until an Allen key (2.5) can be inserted in the screws (B).
- Remove screws (B) and afterwards the printhead (C).
- Remove rear-mounted connection assembly from printhead.

Installing the printhead

- Insert connection assembly to the new printhead.
- Position printhead in printhead support (A), so the engaging pieces catch in the appropriate holes in the printhead support (A).
- Hold printhead holder (A) with a finger slightly on the pressure roll and check the correct position of printhead (C).
- Screw in screw (B) and tighten it with an Allen key.
- Insert again ribbon cassette.
- Enter the resistance value of the new printhead in the 'Service Functions/Heater Resistance'. The value is indicated on the type plate of printhead.
- Start a test print to check printhead position.

Angle adjustment (intermittent mode)

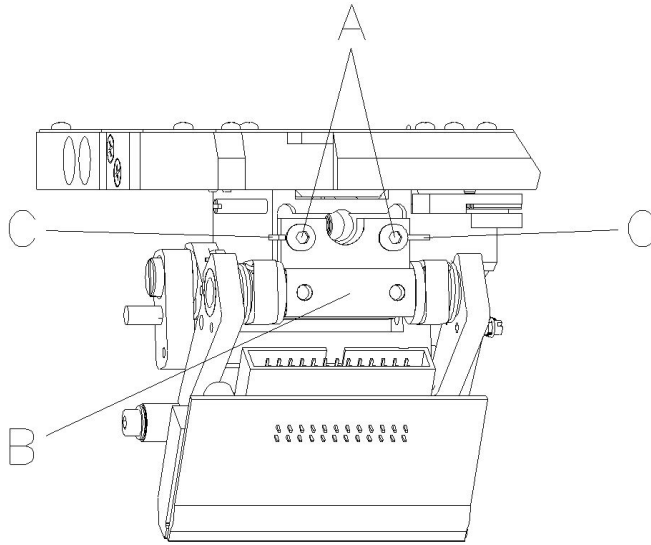

The installation angle of the printhead is default 26° to the print surface. However, manufacturing tolerances of printhead and mechanics can require another angle.



CAUTION!

Damage of printhead by unequal use!
 Higher wastage of ribbon by faster ripping.
 ⇒ Change factory settings only in exceptional cases.

- Loosen slightly two Allen head screws (A).
- Move adjusting part (B) to adjust the angle between printhead and printhead support.
 move downwards = decrease angle
 move upwards = increase angle
- Tighten again the Allen head screws (A).
- Start a print order with approx. 3 layouts to check the correct unwrinkled ribbon run.



NOTICE!

The slots (C) serve for position control. Pay attention to a parallel adjustment.

Guida rapida e sicurezza
del prodotto

Italiano

Copyright by Carl Valentin GmbH

Le indicazioni in merito di fornitura, all'aspetto, alla prestazione, alle dimensioni e al peso rispecchiano le nostre conoscenze al momento della pubblicazione.

Conforme a cambiamento.

Tutti i diritti, compresi quelli della traduzione, riservati.

È vietata la riproduzione, l'elaborazione mediante l'utilizzo di sistemi elettronici o la diffusione in qualsiasi forma (stampa, fotocopia o altro tipo di procedimento) di qualsiasi parte del presente manuale senza l'autorizzazione scritta di Carl Valentin GmbH.

Con il costante sviluppo delle apparecchiature possono verificarsi differenze tra la documentazione e l'apparecchio. L'edizione attuale si trova alla pagina www.carl-valentin.de.

Marchi

Tutti i marchi o marchi di fabbrica citati sono marchi registrati o marchi di fabbrica registrati dei rispettivi proprietari e possono eventualmente non recare indicazioni a parte. Dalla mancanza d'indicazioni a parte non può essere dedotto che non si tratti di un marchio registrato o di un marchio di fabbrica registrato.

I moduli per la stampa diretta Carl Valentin soddisfano le seguenti direttive sulla sicurezza:

- CE** Direttiva macchine CE (98/37/CE)
- Direttiva CE sulla bassa tensione (2006/95/CE)
- Direttiva CE sulla compatibilità elettromagnetica (89/336/CEE)



Carl Valentin GmbH

Postfach 3744
78026 Villingen-Schwenningen
Neckarstraße 78 – 86 u. 94
78056 Villingen-Schwenningen

Phone +49 (0)7720 9712-0
Fax +49 (0)7720 9712-9901

E-Mail info@carl-valentin.de
Internet www.carl-valentin.de

Contenuto

Impiego legittimo	120
Indicazioni di sicurezza	120
Smaltimento ecologico	121
Condizioni d'esercizio	122
Spacchettare il modulo per la stampa diretta	125
Perimetro di consegna	125
Allacciamento del modulo	125
Messa in funzione - preparazione	125
Gestire la stampa	125
Messa in funzione	125
Inserimento la cassetta del nastro	126
Print Settings (Inizializzazione)	127
Machine Parameters (Parametri macchina)	127
Layout Parameters (Layout)	128
Ribbon Save (Ottimizzazione) - Modo continuo	129
Ribbon Save (Ottimizzazione) - Modo intermittente	131
Device Settings (Parametri dell'apparecchio)	132
I/O Parameters (Parametri I/O)	133
Network (Rete)	133
Remote Console (Remote console)	133
Interface (Interfacce)	134
Emulation (Emulazione)	134
Date & Time (Data & Ora)	135
Service Functions (Funzioni d'assistenza)	136
Main Menu (Menu principale)	138
Compact Flash card	139
Dati tecnici	141
Pulizia della testina di stampa	143
Sostituire la testina di stampa	143
Regolamento dell'angolo (modo intermittente)	1414

Uso conforme

- Il modulo per la stampa diretta è costruito secondo lo stato della tecnica e in osservanza delle regole sulla sicurezza tecnica. Ciononostante, durante il suo impiego possono risultare pericoli per l'incolumità dell'utente o di terzi, nonché danneggiamenti al modulo per la stampa diretta e ad altri oggetti di valore.
- Il modulo per la stampa diretta può essere utilizzato solo se in condizioni tecnicamente perfette, in conformità con la normativa vigente e con consapevolezza dei requisiti di sicurezza e dei pericoli in osservanza delle istruzioni per l'uso! In particolare i guasti che possono comprometterne la sicurezza devono essere eliminati immediatamente.
- Il modulo per la stampa diretta è destinato esclusivamente alla stampa di materiali adeguati il cui uso è autorizzato dal produttore. Un uso diverso più ampio non è regolamentare. Il produttore/fornitore non risponde di danni risultanti da un utilizzo improprio, il rischio è solo dell'utente.
- Dell'uso regolamentare fa parte anche l'osservanza delle istruzioni per l'uso, incluse le raccomandazioni/prescrizioni del produttore in merito alla manutenzione.

Indicazioni di sicurezza

- Il modulo per la stampa diretta è concepito per reti elettriche con tensione alternata di 110-230 V. Collegare il modulo per la stampa diretta solo a prese con contatto per conduttore di protezione.



AVVISO!

Quando si cambia la tensione di rete, si deve adeguare il valore di sicurezza (vedi 'dati tecnici').

- Collegare il modulo per la stampa diretta solo ad apparecchiature con tensione inferiore.
- Prima di stabilire o staccare collegamenti, spegnere tutte le apparecchiature interessate (computer, stampante, accessori).
- Utilizzare il modulo per la stampa diretta solo in un ambiente asciutto e non esporlo ad acqua (spruzzi d'acqua, nebbia ecc.).
- Il modulo per la stampa diretta non può essere utilizzato in ambienti a rischio di esplosione, né nelle vicinanze di linee ad alta tensione.
- Utilizzare l'apparecchio soltanto in ambienti protetti da pulviscoli di rettifica, trucioli di metallo e corpi estranei simili.
- Se il modulo per la stampa diretta è utilizzato con il coperchio aperto, accertarsi che capelli, gioielli o simili non entrino in contatto con le parti rotanti esposte.



AVVISO!

Con il modulo per la stampa liberamente accessibile, i requisiti della norma EN60950-1 relativamente agli alloggiamenti di protezione dagli incendi non possono essere soddisfatti per problematiche costruttive. La conformità ai requisiti deve essere garantita mediante l'installazione nell'apparecchio terminale.

- Durante la stampa il modulo della stampa può diventare caldo. Non toccare il modulo per la stampa durante l'uso e lasciare che si raffreddi prima di procedere alla sostituzione dei materiali, allo smontaggio o alla regolazione.
- Effettuare solo quanto descritto nelle presenti istruzioni per l'uso. Attività diverse possono essere eseguite solo dietro esplicito consenso del produttore.
- Un intervento scorretto sui gruppi elettronici e i relativi software può provocare dei guasti.
- Lavori o modifiche scorretti dell'apparecchio possono pregiudicarne la sicurezza di funzionamento.
- Far sempre eseguire gli interventi di manutenzione dal personale di un'officina qualificata in possesso delle conoscenze specialistiche e dell'attrezzatura necessarie nel caso specifico.
- Sugli apparecchi sono apposti diversi avvertimenti che indicano i pericoli potenziali. Non rimuovere questi adesivi. In caso contrario, sarà impossibile identificare i pericoli.
- In fase di montaggio nella macchina il modulo per la stampa diretta deve essere collegato al circuito d'arresto d'emergenza.
- Prima di mettere in servizio la macchina, installare tutti i dispositivi di sicurezza.



PERICOLO!

Pericolo di morte dovuto alla tensione di rete!

⇒ Non aprire l'involucro esterno del modulo per la stampa diretta.

Smaltimento ecologico

Dal 23.03.2006, i fabbricanti di apparecchi B2B sono tenuti a riprendere e riciclare gli apparecchi usati prodotti dopo il 13.08.2005. In principio, questi apparecchi usati non possono essere smaltiti presso i centri di raccolta comunali. Essi devono essere riciclati ed eliminati soltanto dai fabbricanti ed in maniera strutturata. Questo tipo di prodotto marchiato Valentin potrà pertanto essere rinviato a Carl Valentin GmbH.

Gli apparecchi usati saranno allora smaltiti a regola d'arte.

Carl Valentin GmbH osserva così tutti i doveri nell'ambito dello smaltimento degli apparecchi usati permettendo inoltre la distribuzione agiata dei prodotti. Possiamo riprendere soltanto apparecchi inviati franco di porto.

Più informazioni rilevabili dalla direttiva WEEE o sul nostro sito www.carl-valentin.de

Condizioni d'esercizio

Le condizioni di funzionamento rappresentano i presupposti da rispettare prima della messa in funzione e durante il funzionamento dei nostri apparecchi, al fine di ottenere un funzionamento sicuro e privo di guasti.

Leggere attentamente le condizioni di funzionamento.

In caso di dubbi circa la messa in pratica delle condizioni di funzionamento, rivolgersi a noi o al servizio di assistenza ai clienti.

Condizioni generali

Trasportare ed immagazzinare i moduli per la stampa diretta esclusivamente nell'imballo originale.

Installare e avviare i moduli per la stampa diretta dopo aver realizzato le condizioni d'esercizio.

La messa in servizio è vietata finché non viene accertato che, ove applicabile, la macchina in cui deve essere montata la macchina incompleta è conforme alle disposizioni della Direttiva macchine 2006/42/CE.

Procedere all'avvio, programmazione, utilizzo, pulizia e servizio dei nostri moduli per la stampa diretta solo dopo un'accurata lettura dei manuali d'uso.

I moduli per la stampa diretta devono essere utilizzati esclusivamente da personale addestrato.



AVVISO!

Si raccomandano training regolari.

I contenuti dei training sono al capitolo 'Condizioni d'esercizio', 'Inserimento del materiale' e capitolo 'Pulizia e manutenzione'.

Le note valgono anche per le apparecchiature esterne da noi fornite.

È necessario utilizzare esclusivamente i pezzi di ricambio originali.

Per i ricambi e i pezzi soggetti ad usura, rivolgersi al produttore.

Avvertimenti in riguardo alla batteria litio

La batteria litio (tipo CR 2032), che si trova sulla CPU del modulo per la stampa diretta è sottoposta al regolamento di batterie, il quale prevede lo smaltimento di batterie vuote come rifiuti pericolosi. Le batterie devono essere gettate in contenitori adatti. Nel caso che le batterie non sono completamente scariche, si deve prendere dei provvedimenti per causare un corto circuito. Nel caso che il modulo per la stampa diretta venga messo fuori uso è importante smaltire la batteria separata dal modulo per la stampa diretta.



PERICOLO!

Pericolo di morte in seguito ad esplosione!

⇒ Utilizzare un utensile non conduttore.

Condizioni in sede d'installazione

Installare le stampanti su una superficie piana e priva di vibrazioni. Evitare correnti d'aria.

Le stampanti devono essere installate in modo tale da garantire un funzionamento ottimo.

Installazione dell'alimentazione

L'installazione dell'alimentazione per il collegamento dei nostri moduli per la stampa diretta, deve essere effettuata nel rispetto alle norme e disposizioni internazionali:

- International Electronic Commission IEC
- CENELEC European Committee for Electrotechnical Standardization
- VDE Verband Deutscher Elektrotechniker

I nostri moduli per la stampa diretta sono costruiti a norma VDE e devono essere collegati ad un conduttore collegato a massa per eliminare tensioni di disturbo interne. L'alimentatore deve essere dotato di un conduttore di terra.

Dati tecnici dell'alimentazione

Tensione e frequenza della linea d'alimentazione:	vedi targhetta
Tolleranza dell'alimentazione dalla rete consentita:	da +6% a -10% dal valore nominale
Tolleranza della frequenza di rete consentita:	da +2% a -2% dal valore nominale
Fattore di distorsione dell'alimentazione dalla rete consentito:	<=5%

Misure contro le interferenze:

Alla presenza di una rete "disturbata" (ad esempio per l'uso di macchine controllate ad inverte) è necessario adottare specifiche misure contro le interferenze, ad esempio:

- Prevedere un'alimentazione separata per i nostri moduli.
- Adottare un trasformatore d'isolamento a capacità disaccoppiata o analogo soppressore d'interferenze davanti ai nostri moduli.

Radiazione parassita e immunità di disturbi

Interferenze/Emissione secondo EN 61000-6-4: 08-2002.

- Tensione parassita sulle linee secondo EN 55022: 09-2003.
- Intensità campo di interferenza secondo EN 55022: 09-2003.
- Correnti armoniche (reazione rete) secondo EN 61000-3-2: 09-2005
- Flicker secondo EN 61000-3-3: 05-2002

Resistenza all'interferenza/Immunità secondo EN 61000-6-2: 03-2006.

- Immunità dalle scariche di elettricità statica ai sensi della EN 61000-4-2: 12-2001
- Campi magnetici ai sensi della EN 61000-4-3: 11-2003
- Immunità dalle grandezze perturbatrici transitori rapidi (Burst) ai sensi della EN 61000-4-4: 07-2005
- Immunità dalle tensioni impulsive (Surge) ai sensi della EN 61000-4-5: 12-2001
- Frequenze alte ai sensi della EN 61000-4-6: 12-2001
- Interruzione di tensione e abbassamento di tensione ai sensi della EN 61000-4-11: 02-2005



AVVISO!

Questo è un dispositivo di classe A. In ambiente domestico potrebbe provocare effetti di radiodisturbi. In questo caso il gestore è obbligato di attuare misure idonee.

Sicurezza della macchina

- EN 415-2 – Sicurezza delle macchine per imballare
- EN 60204-1:2006 – Sicurezza del macchinario – Equipaggiamento elettrico delle macchine – Parte 1

Collegamento delle linee a macchine esterne

Tutte le linee di collegamento devono essere schermate. La schermatura deve essere collegata su entrambi i lati alla guaina del connettore.

Non è ammesso cablare le linee parallelamente alle linee d'alimentazione. Se ciò dovesse essere inevitabile, mantenere una distanza di almeno 0,5 m.

Temperature tra le linee: -15 al limite di +80 °C.

Si possono collegare solamente apparecchi che corrispondono alle norme di 'Safety Extra Low Voltage' (SELV). In generale questi apparecchi sono controllati secondo la norma EN 60950.

Spacchettare il modulo per la stampa diretta

- ⇒ Sollevare il modulo per la stampa diretta dal cartone.
- ⇒ Verificare che il modulo per la stampa diretta non si sia danneggiato durante il trasporto.
- ⇒ Verificare la presenza di tutte le parti.

Perimetro di consegna

- Meccanica di stampa.
- Guida elettronica.
- Cavo principale.
- Cavi di collegamento (sensori, Power).
- Regolatore.
- Manometro.
- Tubo pneumatico.
- Collegamento a incastro.
- Accessori I/O (contro-pezzo per I/O, cavo I/O 24).
- 1 rotolo di nastro di trasferimento.
- Nucleo di cartone (vuoto), montato su avvolgitore del nastro.
- Foglio di pulitura per pulire la testina di stampa.
- Documentazione.
- CD con driver.



AVVISO!

Conservare l'imballo originale, per poterlo riutilizzare in seguito qualora si renda necessario trasportare l'apparecchio.

Allacciamento del modulo

Il modulo per la stampa diretta è dotato di un alimentatore ad ampia tensione. È dunque possibile utilizzare una tensione di rete di 110-230 V / 50-60 Hz senza apportare modifiche all'apparecchiatura.



ATTENZIONE!

Danneggiamento dell'apparecchio dovuto a correnti di transitorio non definite.

- ⇒ Prima di effettuare l'allacciamento alla rete, portare l'interruttore di rete nella posizione 'O'.
- ⇒ Inserire il cavo di rete nella presa .
- ⇒ Inserire la spina del cavo di rete nella presa collegata a terra.



AVVISO!

Sono possibili disturbi di funzionamento a causa di un collegamento a terra insufficiente o del tutto assente. Accertarsi che tutti i computer collegati al modulo di layout e i cavi di collegamento siano collegati a terra.

- ⇒ Collegare il modulo per il modulo diretto al computer o alla rete con un cavo adatto.

Messa in funzione - preparazione

- ⇒ Montare la meccanica di stampa.
- ⇒ Collegare i cavi della meccanica di stampa e dell'unità elettronica, assicurandosi che i cavi non possono essere scollegati inavvertitamente.
- ⇒ Collegare l'aria compressa.
- ⇒ Attivare il collegamento tra l'unità elettronica e interfacce.
- ⇒ Attivare il collegamento tra l'unità elettronica e l'imballatrice, attraverso l'entrate e uscite I/O.
- ⇒ Collegare il cavo generale dell'unità elettronica.

Gestire la stampa

Siccome il modulo per la stampa diretta si trova sempre nel modo di esercizio "Dispenser", gli ordini di stampa possono essere solamente trasmessi attraverso le interfacce (seriale, parallela, USB o Ethernet), però non è possibile avviare la stampa. La stampa si attiva attraverso un segnale d'avvio, gestito da un'entrata I/O.

Messa in funzione

Una volta stabiliti tutti i collegamenti:

- ⇒ Accendere il modulo per la stampa diretta dall'interruttore di rete. All'accensione del modulo per la stampa diretta compare sul display il menu base che visualizza il tipo del modulo, l'ora e la data attuale.
- ⇒ Inserire della cassetta del nastro di trasferimento. Dopo l'inserimento della cassetta, si attiverà la misurazione del nastro di trasferimento. La testina di stampa sarà posizionata sul punto neutro.

Inserimento la cassetta del nastro



AVVISO!

È necessario considerare l'uso di nastri antistatici. Le cariche elettrostatiche possono danneggiare la testina di stampa (il rivestimento della testina di stampa) o altri elementi elettronici.

L'utilizzo di materiali non adatti causa funzionamenti erranei e può far scadere la garanzia.

Colore esterno



AVVISO!

Consigliamo di pulire la testina di stampa con un detersivo speciale (97.20.002), prima di inserire un nastro di trasferimento nuovo.

Devono essere osservate le norme per l'uso di isopropanolo (IPA). In caso di contatto con la pelle o con gli occhi, risciacquare bene con acqua corrente. In caso di irritazione persistente, contattare un medico. Assicurarsi che vi sia una aerazione sufficiente.

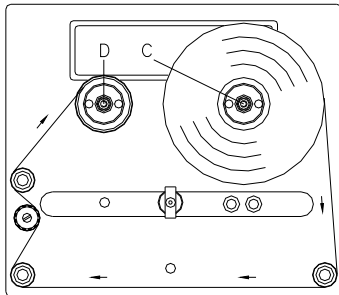
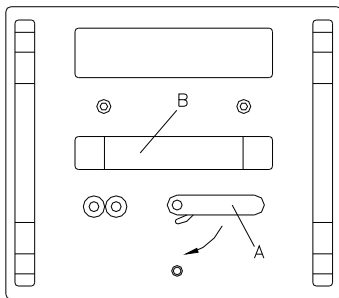

L'illustrazione mostrata in alto, mostra una versione sinistra. Versione destra: Inserire il rotolo nuovo sulla parte sinistra e il nucleo di cartone sul lato destro.

- Ruotare la leva (A) in senso orario per 90°.
- Rimuovere la cassetta dalla meccanica di stampa, tirando al manico (B).
- Inserire il nuovo rotolo con il nastro di trasferimento (fino all'arresto) sul svolgitoro (C).
- Inserire il rotolo di cartone vuoto sul avvolgitoro (D) (fino all'arresto).
- Inserire il nastro di trasferimento come visualizzato in alto.
- Fissare il nastro di trasferimento, con un nastro adesivo, sul rotolo vuoto. Per tendere il nastro, ruotare alcune volte il rotolo vuoto.
- Inserire la cassetta sulla meccanica di stampa, facendo attenzione di non danneggiare il nastro di trasferimento.
- Ruotare la leva (A) in senso antiorario per 90°.

Colore interno

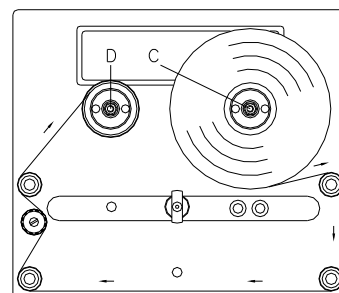
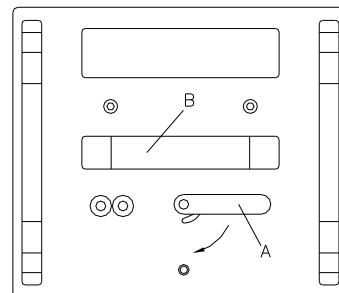

L'illustrazione mostrata in alto, mostra una versione sinistra. Versione destra: Inserire il rotolo nuovo sulla parte sinistra e il nucleo di cartone sul lato destro.

- Ruotare la leva (A) in senso orario per 90°.
- Rimuovere la cassetta dalla meccanica di stampa, tirando al manico (B).
- Inserire il nuovo rotolo con il nastro di trasferimento (fino all'arresto) sul svolgitoro (C).
- Inserire il rotolo di cartone vuoto sul avvolgitoro (D) (fino all'arresto).
- Inserire il nastro di trasferimento come visualizzato in alto.
- Fissare il nastro di trasferimento, con un nastro adesivo, sul rotolo vuoto. Per tendere il nastro, ruotare alcune volte il rotolo vuoto.
- Inserire la cassetta sulla meccanica di stampa, facendo attenzione di non danneggiare il nastro di trasferimento.
- Ruotare la leva (A) in senso antiorario per 90°.

Print Settings (Inizializzazione della stampa)

Sequenza di tasti: **F**

Menu funzioni
Inizializzazione

Tasto:

Modo continuo

Contrasto
(in %) 100

Contrast (Forza d'accensione):

Valori impostabili: 10% ... 200 %.

Modo intermittente

Velocità: 100
Forza: 100

Speed (Velocità):

Valori impostabili: 50 mm/s ... 200 mm/s.

Contrast (Forza d'accensione):

Valori impostabili: 10% ... 200 %.

Tasto:

Verifica TCR
ON sens. forte

Transfer ribbon control (Controllo del nastro di trasferimento):

Off: Il controllo del nastro di trasferimento non è attivo.

On: Il controllo del nastro di trasferimento è attivo.

strong sensibility (sensibilità forte): Il modulo reagisce immediatamente, alla fine del nastro di trasferimento.

weak sensibility (sensibilità debole): Il modulo reagisce di ca. 1/3 più lentamente alla fine del nastro di trasferimento.

Tasto:

Spostamento X
Offs (mm): -1.5

X-displacement (Spostamento X):

Indica lo spostamento trasversale del punto d'origine espresso in mm.

Valori impostabili: -90.0 ... +90.0.

Machine Parameters (Parametri macchina)

Modo continuo

Sequenza di tasti: **F**,

Menu funzioni
Param. macchina

Tasto:

Modo
IO DY C

Mode (Modo):

Consente di selezionare il modo d'esercizio

Tasto:

Offset di stampa
(mm) 10.0

Print offset (Offset di stampa):

Distanza del layout rispetto al punto zero della macchina.

Valori ammissibili: 1 ... 999 mm

Tasto:

Pos. di stampa
(mm) 20.0

Print position (Posizione di stampa):

La posizione di partenza della slitta di stampa in mm.

Valori ammissibili: 12 ... 93 mm

Tasto:

Layout/ciclo
1

Layouts/cycle (Layout/ciclo):

Numero di layout stampati pro avvio di stampa (ciclo).

Valori ammissibili: 1 ... 25.

Modo intermittente

Sequenza di tasti: **F**,

Menu funzioni
Param. macchina

Tasto:

Modo
Continuo

Mode (Modo): Consente di selezionare il modo d'esercizio

Tasto:

Velo. ritiro mm/s
200

Back speed (Velocità del ritiro):

Velocità del ritiro della meccanica di stampa in mm/s.

Valori ammissibili: 50 ... 600 mm/s.

Tasto:

Offset di stampa
(mm) 10.0

Print offset (Offset di stampa):

Distanza del layout rispetto al punto zero della macchina.

Valori ammissibili: 1 ... 999 mm

Tasto:

Pos. di stampa
(mm) 20.0

Print position (Posizione di stampa):

La posizione di partenza della slitta di stampa in mm.

Valori ammissibili: 12 ... 93 mm

Modo continuoTasto: 

```
ChkSpeed On Strt
Off
```

Check speed on start (Controllare la velocità del materiale):

Controllare la velocità del materiale, quando il modulo riceve il segnale d'avvio.

Tasto: 

```
Ris.      mm/360°
2000     166
```

Encoder resolution / material feed per encoder rotation (Risoluzione encoder / Avanzamento del materiale):

Visualizza la risoluzione dell'encoder utilizzato e l'avanzamento del materiale (per ogni rotazione dell'encoder), in mm.

Tasto: 

```
Velo.materiale
200 mm/s
```

Material speed (Velocità del materiale):

Indica la velocità del materiale.

Modo intermittenteTasto: 

```
Layout/ciclo
1
```

Layouts/cycle (Layout/ciclo):

Numero di layout stampati pro avvio di stampa (ciclo). Valori ammissibili: 1 ... 25.

Layout Settings (Layout)Sequenza di tasti: **F**, , 

```
Menu funzioni
Layout
```

Tasto: 

```
Lung.Stampa (mm)
140.0
```

Tasto: 

```
Larghezza: 20.0
Num. colonne: 4
```

Tasto: 

```
Materiale
Tipo 2
```

Tasto: 

```
Specchiare
On
```

Tasto: 

```
Girare layout
Off
```

Tasto: 

```
Regolazione
Sinistra
```

Print length (Lunghezza stampa):

Indica la strada che la meccanica di stampa deve fare (per iniziare la stampa). La lunghezza di stampa dipende dalla lunghezza della meccanica.

Column printing (Stampa a colonne):

Indica la larghezza di un layout e quanti layouts devono essere stampati l'una accanto all'altra

Material selection (Selezione del materiale):

Selezione della media di stampa utilizzato

Flip layout (Specchiare il layout):

L'asse specchio si trova al centro del layout. Se la larghezza del layout non è stata trasmessa al modulo di stampa, si applica la larghezza layout default, vale a dire la larghezza della testina di stampa. Per evitare problemi di posizionamento è necessario che la larghezza del layout corrisponde a quella della testina.

Rotate layout (Girare layout):

Il modulo standard, stampa i layout con testa in avanti e senza girarlo 0°. Attivando questa funzione il layout sarà girato di 180 in direzione di lettura.

Alignment (Regolazione):

Il posizionamento del layout avviene soltanto dopo la rotazione/specchiatura, vale a dire che il posizionamento è indipendente dalle funzioni "rotazione/specchiatura".

Left (Sinistra) – la posizione del layout è sul bordo destro della testina di stampa.

Centre (Centro) – la posizione del layout è al centro della testina di stampa.

Right (Destra) – la posizione del layout è sul bordo destro della testina di stampa.

Ribbon Save (Ottimizzazione) - Modo continuo

Sequenza di tasti: **F**, , , 

Menu Funzioni
Ottimizzazione

Tasto: 

Mode Speed
Standard 600

Operating mode (Tipo di ottimizzazione):

Selezione del tipo di ottimizzazione.

Off: Ottimizzazione disattivata.

Standard (Standard): Performance di ottimizzazione massima, quest'impostazione elimina cioè ogni possibilità di perdita del nastro di trasferimento (ad esclusione di 1 mm di distanza di sicurezza per evitare che i campi stampa vengano stampati gli uni negli altri). stampa imposta automaticamente l'ottimizzazione della qualità in base alle esigenze.

Speed (Velocità): Definizione della velocità di stampa massima.

Tutti i calcoli vengono effettuati in base a tale dato

Modo: Standard

R-Correction
-1 mm

Transfer ribbon correction (Correzione del nastro di trasferimento):

0 mm = Il ritiro avviene sempre in modo da ottenere la migliore ottimizzazione possibile (nessuna perdita del nastro di trasferimento).

Valore default: 0 mm

-xx mm = È possibile ridurre il ritiro.

+xx mm = È possibile aumentare il ritiro.

Tasto: 

sa/mm cmin so/mm
303 1000 10

Performance information (Informazioni sulle prestazioni):

sa/mm: La distanza minima fra due impressioni ad ottimizzazione massima.

cmin: Numero max. di cicli al minuto.

so/mm: Indicazione della perdita di ottimizzazione

Tasto: 

ExpertParameters

Expert parameters (Parametri per utenti esperti): protetta da una password

Premere il tasto  per confermare l'immissione. In seguito vengono visualizzati i parametri seguenti:

Tasto: 

PhDownT REStartT
30 ms 10 ms

PhDownT = Printhead down time in ms (Tempo di abbassamento testina di stampa):

Utilizzato dall'algoritmo di ottimizzazione per calcolare il punto di partenza (start) del movimento verso il basso della testina di stampa

REStartT = Ribbon motor early start time in ms (Motore nastro tempo di avvio):

Questo valore viene addizionato al tempo di aumento del movimento nastro di trasferimento. Indicazione del tempo compreso fra 'Il motore ha raggiunto la velocità del materiale' e 'La testina di stampa brucia'.

Tasto: 

MinSpeed CalcOff
50 mm/s On

MinSpeed = Minimal print speed (Min. velocità di stampa):

Se la velocità di stampa aumenta, aumenta anche il numero max. dei cicli.

CalcOff = Print offset border calculation (Calcolo offset stampa):

Se si imposta il parametro su Off, è possibile inserire un valore inferiore all'offset stampa necessario.

Tasto: 

PhUpT PhVReactT
20 ms 10 ms

PhUpT = Printhead up time in ms (Tempo di sollevamento testina di stampa):

Utilizzato dall'algoritmo di ottimizzazione per calcolare se è possibile effettuare un'ottimizzazione campo o meno

PhVReactT = Printhead valve reaction time in ms (Tempo di reazione valvola testina di stampa):

Viene calcolato quando inizia lo spostamento verso l'alto della testina di stampa.

Tasto: 

RibMotStpDlayT
2 ms

RibMotStpDlayT = Ribbon motor stop delay time (Tempo di ritardo):

Tempo di ritardo in ms durante il quale il motore del nastro di trasferimento viene ancora mosso con velocità invariata prima dell'arresto.

Tasto: 

FieldRS	Rwind v
Normal	600mm/s

Field ribbon saving (Ottimizzazione campo)**FieldRS = field ribbon saving:****Off:** Ottimizzazione del campo disattivata.**PHOnly:** Si sposta soltanto la testina di stampa. Il nastro di trasferimento non viene arrestato.
Normal (standard): L'ottimizzazione del campo viene eseguita soltanto se il motore del nastro di trasferimento viene completamente arrestato.**Strong (forte):** L'ottimizzazione del campo viene eseguita anche se il motore del nastro di trasferimento non viene arrestato.**Rwind v = Rewind speed in mm/s (Riavvolgimento):**

Indicazione del riavvolgimento in mm/s.

Tasto: 

Speed 1. Field
400 mm/s

Speed 1 field (Velocità campo 1):

Se l'impostazione è 0 (valore default), il parametro non ha alcun effetto sull'ottimizzazione.

Tasto: 

Tension
0 mm

Tension (Tensione):

Indicazione della lunghezza che viene trasportata in avanti dopo la misurazione del nastro di trasferimento.

Modo: Shift

X-Shift	Y-Shift
10 mm	13 mm

X-Shift / Y-Shift (Spostamento X / Y):**X-Shift (Spostamento X):** Indicazione dello spostamento dell'immagine di stampa in direzione X.**Y-Shift (Spostamento Y):** Indicazione dello spostamento nella direzione di stampa.Tasto: 

Lanes	R-Shift
3	-5 mm

Lanes / R-Shift (Colonna / Spostamento R)**Lanes (Colonna):** Indicazione del numero di cicli stampati uno accanto all'altro.**R-Shift ((Spostamento R):** Indicazione della distanza per il passaggio ad un ciclo nuovo.Tasto: 

ExpertParameters

Expert parameters (Parametri per utenti esperti)**Menu protetto con password**Questa opzione menù è protetta da una password. Inserire la password, premere il tasto  per confermare l'immissione.

Per la descrizione dei parametri dei sistemi esperti (ExpertParameters), vedere il modo 'Standard'.

Modo: SaveStrt

ExpertParameters

Expert parameters (Parametri per utenti esperti)**Menu protetto con password**Questa opzione menù è protetta da una password. Inserire la password, premere il tasto  per confermare l'immissione.

Per la descrizione dei parametri dei sistemi esperti (ExpertParameters), vedere il modo 'Standard'.

Ribbon Save (Ottimizzazione) - Modo intermittente

Sequenza di tasti: **F**, , , 

Menu Funzioni
Ottimizzazione

Tasto: 

Mode
Standard

Operating mode (Tipo di ottimizzazione):

Selezione del tipo di ottimizzazione.

Off: Ottimizzazione disattivata.

Standard (Standard): Performance di ottimizzazione massima, quest'impostazione elimina cioè ogni possibilità di perdita del nastro di trasferimento (ad esclusione di 1 mm di distanza di sicurezza per evitare che i campi stampa vengano stampati gli uni negli altri).

Shift (Spostamento): I dati del layout possono essere stampati più volte sfalsati lateralmente. In tal modo è possibile sfruttare al massimo il nastro di trasferimento.

Modo: Standard

R-Correction
-1 mm

Transfer ribbon correction (Correzione del nastro di trasferimento):

0 mm = Il ritiro avviene sempre in modo da ottenere la migliore ottimizzazione possibile (nessuna perdita del nastro di trasferimento).

Valore default: 0 mm

-xx mm = È possibile ridurre il ritiro.

+xx mm = È possibile aumentare il ritiro.

Tasto: 

ExpertParameters

Expert parameters (Parametri per utenti esperti)

Menu protetto con password

Premere il tasto  per confermare l'immissione. In seguito vengono visualizzati i parametri seguenti:

Tasto: 

PhDownT PhUpT
35 ms 0 ms

PhDownT = Printhead down time in ms (Tempo di abbassamento testina di stampa):

Utilizzato dall'algoritmo di ottimizzazione per calcolare il punto di partenza (start) del movimento verso il basso della testina di stampa.

PhUpT = Printhead up time in ms (Tempo di sollevamento testina di stampa):

Utilizzato dall'algoritmo di ottimizzazione per calcolare se è possibile effettuare un'ottimizzazione campo o meno.

Tasto: 

PhVReactT
10 ms

PhVReactT = Printhead valve reaction time in ms (Tempo di reazione):

Viene calcolato quando inizia lo spostamento verso l'alto della testina di stampa.

Tasto: 

Tension RM
0 mm 0

Tension / Ribbon Mode (Tensione / Modalità nastro)

Tension (Tensione): Il nastro di trasferimento viene ritratto su tutta la lunghezza di stamp dopo ogni stampa, cioè non viene effettuata nessuna ottimizzazione fra i diversi layout.

Ribbon Mode (Modalità nastro):

0: Il nastro di trasferimento viene ritratto su tutta la lunghezza di stampa ogni stampa, cioè non viene effettuata nessuna ottimizzazione fra i diversi layout.

1: Il nastro di trasferimento viene ritratto soltanto su una lunghezza corrispondente alla zona stampata, cioè si esegue un'ottimizzazione dei buchi fra i layout.

Quando il layout cambia, il nastro di trasferimento si posiziona automaticamente.

Modo: Shift

X-Shift Y-Shift
10 mm 13 mm

X-Shift / Y-Shift (Spostamento X / Y):

X-Shift (Spostamento X): Indicazione dello spostamento dell'immagine di stampa in direzione X.

Y-Shift (Spostamento Y): Indicazione dello spostamento nella direzione di stampa.

Tasto: 

Lanes R-Shift
3 -5 mm

Lanes / R-Shift (Colonna / Spostamento R):

Lanes (Colonna): Indicazione del numero di cicli stampati uno accanto all'altro.

R-Shift (Spostamento R): Indicazione della distanza per il passaggio ad un ciclo nuovo.

Tasto: 

ExpertParameters

Expert parameters (Parametri per utenti esperti)

Menu protetto con password

Questa opzione menù è protetta da una password. Inserire la password, premere il tasto  per confermare l'immissione.

Per la descrizione dei parametri dei sistemi esperti (ExpertParameters), vedere il modo 'Standard'.

Device Settings (Parametri dell'apparecchio)

Sequenza di tasti: **F**, , , , 

Menu funzioni
Parametri

Tasto: 

Gestione campo
OFF

Field handling (Gestione campo):

Off: L'intera memoria del modulo per la stampa diretta viene cancellata.

Keep graphic (Salvare grafica): Quando un'immagine grafica o un True Type viene trasmesso per la prima volta al modulo per la stampa diretta, il modulo memorizza automaticamente questi dati (nella memoria interna), per poterli riutilizzarli. Per i lavori successivi, vengono trasmessi solamente i dati modificati al modulo, con il vantaggio di un notevole risparmio di tempo nella trasmissione dei dati grafici.

L'immagine dati creati dal modulo (caratteri interni e/o codici a barre) vengano generati soltanto se sono modificati. Viene così risparmiato tempo anche nella generazione del modulo.

Delete graphic (Cancellare grafica): Le grafiche e i font True Type archiviati nella memoria interna del modulo vengono eliminati, ma i campi relativi rimangono in memoria.

Tasto: 

Codepage
GEM tedesco

Codepage (Codepage):

Scelta per il set di caratteri da utilizzare.

Tasto: 

Parametri est.
ON

External parameters (Parametri esterni):

Layout dimension only (Solo misure del layout): I parametri della lunghezza, larghezza e spazio tra un layout e l'altra possono essere inviati. Tutti gli altri parametri devono essere effettuati al modulo per la stampa direttamente.

On: Con il nostro software per la creazione dei layouts è possibile trasmettere i parametri, velocità e intensità di stampa al modulo. Parametri impostati direttamente sul modulo non vengono tenuti in considerazione.

Off: Vengono considerati esclusivamente i valori impostati direttamente sul modulo (i valori trasmessi non vengono tenuti in considerazione).

Tasto: 

Buzzer
On

Buzzer (Cicalino):

On: Abilita il segnale acustico (bip) premendo ad ogni tasto. Valori impostabili: 1 ... 7.

Off: Disabilita il segnale acustico (bip).

Tasto: 

Lingua
Italiano

Language (Lingua):

Selezione della lingua in cui dovrà essere visualizzato il testo sul display del modulo.

Attuale è possibile scegliere tra le lingue: tedesco, inglese, francese, spagnolo, portoghese, olandese, italiano, danese, finlandese, polacco, ceco e russo.

Tasto: 

Input utente
ON

Customized entry (Inserimento utente):

On: L'interrogazione per la variabile della guida utente, sarà visualizzata solo una volta sul display della guida elettronica: prima che l'ordine di stampa si avvia.

Auto: L'interrogazione per la variabile della guida utente si visualizza dopo ogni layout.

Off: Sul display non appare l'interrogazione, per la variabile della guida utente. In questo caso sarà stampato il valore standard impostato.

Tasto: 

Avvio a caldo
Start

Hotstart (Avvio a caldo):

On: Dopo la riaccensione del modulo, un ordine interrotto può essere riavviato (possibile solamente se il modulo è dotato con l'opzione carta Compact Flash).

Off: Quando il modulo viene spento, tutti i dati vanno persi

Tasto: 

Protez. Password
Attiva

Password (Password):

Attraverso una Password è possibile bloccare diverse funzioni. Ci sono diversi motivi, per l'utilizzazione di una Password.

Tasto: 

Conferma layout
On

Layout confirmation (Conferma Layout):

On: Un nuovo job di stampa viene stampato soltanto dopo la conferma sull'apparecchio. La stampa di un job di stampa continua già attivo prosegue finchè non avviene la conferma sull'apparecchio.

Off: Nessun'interrogazione compare sul display del comando.

Tasto: 

Layout standard
Off

Standard layout (Layout standard):

On: Se si avvia un job di stampa senza previa definizione del layout, il layout stampato sarà standard (tipo di apparecchio, versione firmware, versione build).

Off: Se si avvia un job di stampa senza previa definizione del layout, un messaggio di errore compare sullo schermo.

I/O Parameters (Parametri I/O)Sequenza di tasti: , , , , , 

Menu Funzioni
Parametri I/O

Tasti: 

Liv. segnale IN
1s2x3+4x5x6x7x8x

IN signal level (Livello del segnale IN):

Indica a quale segnale deve essere lanciata la stampa.

+ = livello del segnale attivo è 'high' (1)

- = livello del segnale attivo è 'low' (0)

x = livello del segnale non è attivato

s = stato dell'interfaccia è suggestionabile (in associazione a Netstar PLUS)

Tasti: 

Liv. segnale OUT
1+2+3+4+5+6+7+8+

OUT signal level (Livello del segnale OUT):

Indica il livello del segnale d'emissione.

+ = livello del segnale attivo è 'high' (1)

- = livello del segnale attivo è 'low' (0)

s = stato dell'interfaccia è suggestionabile (in associazione a Netstar PLUS)

Tasti: 

Debounce (ms)
50

Debouncing (Debounce):

Indica il tempo per debouncare, l'entrata del segnale distributivo.

Valori ammissibili: 0 fino 100 ms.

Tasti: 

Ritar.stampa (s)
1.0

Start signal delay (Ritardare il segnale d'avvio):

Indica il valore di ritardamento dell'avvio di stampa.

Valori ammissibili: 0.00 fino 9.99.

Tasti: 

ErrorIfNotReady
On

Not ready: error (Non pronto: errore):

On: Se un job di stampa è attivo, ma l'organo di stampa diretta non è pronto ad elaborarlo (ad es. perché si trova già in modalità 'in corso di stampa'), viene emesso un errore.

Off: Nessun messaggio d'errore viene emesso.

Tasti: 

Pronto stampa
Off

Ready while printing (Pronto durante la stampa):

Impostazione per decidere se il segnale di uscita "pronto alla stampa" (out 5, output II) resta attivo durante la stampa.

Off: all'avvio del processo di stampa il segnale "pronto alla stampa" diventa inattivo (impostazione standard).

On: all'avvio del processo di stampa il segnale "pronto alla stampa" resta attivo.

Network (Rete)Sequenza di tasti: , , , , , 

Menu Funzioni
Rete

Troverete maggiori informazioni su quest'opzione menù nel Manuale a parte.

Remote Console (Remote console)Sequenza di tasti: , , , , , , 

Menu Funzioni
Remote Console

Per ulteriori informazioni, rivolgersi al nostro ufficio vendite.

Interface (Interfacce)

Sequenza di tasti: **F**, , , , , , , , 

Menu funzioni
Interfacce

Tasto:

COM1	Baud	P	D	S
0	9600	N	8	2

COM1:

0 - interfaccia seriale Off
1 - interfaccia seriale On
2 - interfaccia seriale On, non viene indicato nessun messaggio in caso d'errore nella trasmissione.

Baud (Baud):

Indica quanti bit vengono trasmessi il secondo: velocità di trasmissione.
Valori impostabili: 1200, 2400, 4800, 9600, 19200, 38400, 57600, 115200.

P = Parity (Parità):

N - No parity
E - Even
O - Odd

È necessario verificare che le impostazioni corrispondono a quelle della porta seriale del PC.

D = Data bits (Bits dei dati):

Impostazione dei Bit di dati; Valori impostabili: 7 oppure 8 Bits.

S = Stop bits (Bit di stop):

Indicazione dei bits di stop tra i Bytes. Valori impostabili: 1 oppure 2 Bit di stop.

Tasto: 

Inizio (SOH):	01
Fine (ETB):	17

Start/stop sign (Carattere di partenza/finale):

SOH: Inizio della trasmissione del blocco di dati → formato HEX 01

ETB: Fine della trasmissione del blocco di dati → formato HEX 17

Tasto: 

Memoria dati
Standard

Data memory (Memoria dati):

Standard (Standard): Dopo l'avvio di un ordine di stampa dati vengono ricevuti finché il buffer di stampa è pieno.

Extended (Estesa): Durante la stampa i dati vengono ricevuti e rielaborati.



Off: Durante la stampa non vengono ricevuti dati ulteriori.

Tasto: 







Porttest OFF

Port test (Controllo interfacce):

Controllo se dati trasmetteranno attraverso l'interfaccia.

Premere i tasti  e  per selezionare "In generale" (ON). Premere il tasto e vengono così stampati i dati che sono stati inviati attraverso una porta preferita (COM1, LPT, USB, TCP/IP).

Emulation (Emulazione)

Sequenza di tasti: **F**, , , , , , , , 

Menu Funzioni
Emulazione



Tasto:

Protocollo
ZPL

Protocol (Protocollo):

CVPL: Carl Valentin Programming Language

ZPL: Zebra® Programming Language

Con i tasti  e  è possibile scegliere il protocollo. Premere il tasto per confermare la selezione. La stampante si riavvia e trasforma internamente i comandi ZPL II® in comandi CVPL e li esegue.

Tasto: 

Risoluzione tes.
11.8 (Dot/mm)

Printhead resolution (Risoluzione testina di stampa):

Se l'emulazione ZPL II® è attivata, è necessario impostare la risoluzione della testina di stampa della stampante emulata.

Tasto: 

Assegnazione
B:->A: R:->R:

Drive mapping (Assegnazione unità):

L'accesso ai drive Zebra® viene deviato su drive Valentin corrispondenti.

Date & Time (Data & Ora)

Sequenza di tasti: **F**, , , , , , , , , , 





Menu funzioni
Data/Ora

Tasto: 

Data 17.22.04
Ora 13:28:06

Set date/time (Modificare la data e l'ora):

La prima riga del display indica la data attuale. La seconda riga mostra l'ora attuale.

Premere i tasti  e  per passare al prossimo campo. Con i tasti  e  è possibile aumentare / diminuire i valori impostati.

Tasto: 

Ora estiva
On

Summertime (Orario estivo):

On: Il modulo passa automaticamente dall'ora estiva all'ora invernale (e viceversa).

Off: L'entrata in vigore dell'ora legale non viene rilevata automaticamente e l'ora non viene quindi cambiata.

Tasto: 

Formato inizio
WW/WD/MM

Start of summertime - format (Inizio del orario estivo - formato):

Con questa funzione si sceglie il formato, di come deve essere impostato l'ora estiva.

DD = Giorno

WW = Settimana

WD = Giorno della settimana

MM = Mese

YY = Anno,

next day = viene considerato il prossimo giorno

Tasto: 

WW WD MM
last Sunday 03

Start of summertime - date (Inizio del orario estivo - data):

Impostare la data da quando deve iniziare l'orario estivo.

Con l'aiuto di questa funzione, si inserisce la data, dalla quale deve iniziare l'ora estiva. Questo inserimento si riferisce al formato selezionato prima.

Nell'esempio, l'ora cambia l'ultima domenica di marzo (03).

Tasto: 

Ora dell'inizio
02:00

Start of summertime - time (Inizio del orario estivo - orario):

Impostare l'orario da quando deve iniziare l'ora estiva.

Con l'aiuto di questa funzione, si inserisce l'orario da, quando deve iniziare l'ora estiva.

Tasto: 

Formato fine
WW/WD/MM

End of summertime - format (Fine del orario estivo - formato):

Con questa funzione, si seleziona il formato per impostare la fine dell'ora estiva.

Tasto: 

WW WD MM
last Sunday 10

End of summertime - date (Fine del orario estivo - data):

Con l'aiuto di questa funzione è possibile impostare la data, da quando deve finire la data estiva. Questa impostazione si riferisce al formato selezionato prima.

Nel esempio mostrato sul display, l'ora estiva finisce l'ultima domenica (10) di ottobre.

Tasto: 

Ora pour la fine
03:00

End of summertime - time (Fine del orario estivo - orario):

Con l'aiuto di questa funzione, si inserisce l'orario a qui deve terminare l'ora estiva.

Tasto: 

Time shifting
01:00

Time shifting (Spostamento dell'ora):

Con l'aiuto di questa funzione, si può impostare il spostamento dell'orario (ora estiva/invernale) in ore e minuti.

Service Functions (Funzioni d'assistenza)



AVVISO!

Per consentire al rivenditore o al produttore dell'apparecchio di fornire più rapidamente assistenza in caso di necessità, è prevista la possibilità di leggere le informazioni necessarie, come ad esempio i parametri impostati, direttamente sull'apparecchio.

Sequenza di tasti: **F**, , , , , , , , , , , 

Menu funzioni
Fun. assistenza

Tasto: 

H P R1 R2 C ENC
0 1 1 0 0 0

Photocell parameters (Parametri fotocellula):

H = Interruttore per coperchio (0 = chiuso; 1 = aperto).

P = Pressure

Indica il valore per controllare l'aria compressa 0 oppure 1.

R1 = Rotolo per svolgere il nastro di trasferimento

Indica lo stato del rotolo per svolgere il nastro di trasferimento. Regolabile da 0 a 2.

4 Visualizzazione dei stati (nessun marcaggio nella fotocellula, marcaggio da destra, marcaggio da sinistra, marcaggio si trova completamente nella fotocellula).

R2 = Rotolo per svolgere il nastro di trasferimento

Indica lo stato del rotolo per avvolgere il nastro di trasferimento. Regolabile da 0 a 2.

4 Visualizzazione dei stati (nessun marcaggio nella fotocellula, marcaggio da destra, marcaggio da sinistra, marcaggio si trova completamente nella fotocellula).

C = Carriage

Indica la posizione di partenza della slitta di stampa in mm.

ENC = Encoder: Indica lo stato in cui si trova l'encoder.

Tasto: 

Velo. tracc. (m)
D000007 G000017

Paper counter (Metri stampati):

D: Indica quanti metri ha stampato la testina di stampa

G: Indica quanti metri ha stampato il modulo.

Tasto: 

Resistenza
1250

Heater resistance (Resistenza dot):

All'installazione della testina di stampa è necessario impostare il valore Ohm indicato sulla testina di stampa per ottenere una stampa corretta.

Tasto: 

Temp. testina
23

Printhead temperature (Temperatura della testina di stampa):

Indica la temperatura della testina di stampa. Se la testina di stampa raggiunge una temperatura troppo elevata, l'ordine di stampa viene interrotto e un avviso d'errore appare sul display del modulo.

Tasto: 

Ribbon Ink Side
600 m Out

Ribbon / Ink side (Lunghezza del nastro / Avvolgimento):

Ribbon (Lunghezza del nastro): Selezione della lunghezza del nastro di trasferimento utilizzato (300 m, 450 m, 600 m, 900 m, 1000 m). I nastri di trasferimento più corti permettono di ottenere prestazioni ciclo superiori.

Ink side (Avvolgimento): Selezione dell'uso di nastri di trasferimento con avvolgimento esterno od interno.

Default: Avvolgimento esterno

Tasto: 

BrkPow BrkPowP
100 % 100 %

Brake power (Prestazione freno):

BrkPow: Regolazione del freno per accelerazione e frenatura in %

BrkPowP: Regolazione del freno durante la stampa in %.

Tasto: 

Esempi di stampa
Status Report

Print examples (Esempi di stampa):

Attivando questa voce di menu si ottiene una stampa con tutte le impostazioni del modulo per la stamp.

Settings (Parametri):

Attivando questa voce del menu si ottiene una stampa con tutte le impostazioni. Ad esempio: velocità, materiale delle etichette, nastro di trasferimento etc.

Bar codes (Codici a barre):

Attivando questa voce del menu si ottiene una stampa di tutti i codici a barre disponibili.

Fonts (Fonts):

Attivando questa voce del menu si ottiene la stampa di tutti i font vettoriali e dei bitmap fonts.

Tasto: 

Input: 11111111
Output: 00000000

Input/output (Input/Output):

Indica il livello dei segnali della scheda interfaccia I/O.

0 – Low, 1 – High

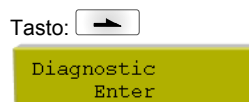
**Diagnostic (Diagnosi):**

Premere il tasto  per accedere al menù Diagnosi.

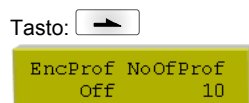
**Encoder profiling (Profilo encoder):**

I valori encoder con l'avvio stampa nei file Logging vengono registrati sulla carta CF. Grazie a questi dati, è possibile creare un diagramma grafico della curva encoder.

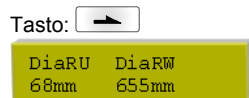
**Roller diameter (Diametro dei rulli del nastro di trasferimento):**

DiaRW = Diametro del rullo avvolgitore nastro di trasferimento.

DiaRU = Diametro del rullo svolgitore nastro di trasferimento.

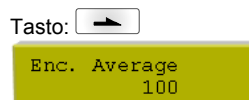
**Encoder average (Segnale encoder):**

Numero dei valori attraverso i quali vengono trasmessi i segnali encoder.

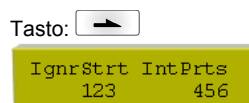
**Diagnostic - Counter (Diagnosi - Contatore):**

Gli eventi rilevanti vengono contati e documentati nella memoria RAM. La documentazione viene persa non appena si disinserisce l'apparecchio.

IgnrStrt = Contatore dei segnali di avvio ignorati.

IntPrts = Contatore dei jobs di stampa annullati.

Con il cursore, selezionare il valore sul quale si desidera ottenere maggiori informazioni e premere il tasto .

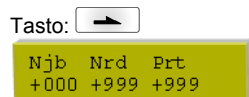
**Njb =No job (Nessun job di stampa):**

Contatore dei segnali di avvio ignorati perché il job di stampa non era attivo.

NRd = Not ready (Non pronto):

Contatore dei segnali di avvio ignorati perché il job di stampa non era pronto (arrestato o messaggio di errore).

Prt = Printing (Stampa):

Contatore dei segnali di avvio ignorati durante l'apparecchio stampi/sia attivo.

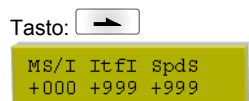
**MS/I = Manual stopped/interrupted (manuale arrestato/interrotto):**

Il tasto Stop è stato premuto sulla tastiera a membrana, sul pannello od in un programma.

ItfI = Interface interrupted (Interrotto da interfaccia):

Il job di stampa è stato interrotto perché nuovi dati sono stati ricevuti attraverso un'interfaccia.

SpdS = Speed stopped (Interrotto da velocità):

Il job di stampa è stato interrotto perché la velocità di stampa misurata era insufficiente.

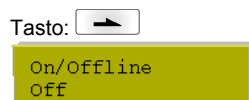
**Online/Offline (Online/Offline):**

Questa funzione viene attivata per esempio quando si deve sostituire il nastro colore. In tal modo si evita che il job di stampa venga elaborato malgrado l'apparecchio non sia ancora pronto. Se la funzione è attivata, il tasto  permette di passare dalla modalità Online alla modalità Offline e viceversa. Lo stato attuale è indicato sul display.

Standard: Disattivata.

Online (Online): I dati vengono trasmessi mediante delle interfacce. I tasti della tastiera a membrana sono attivi soltanto se si è passati alla modalità Offline premendo il tasto .

Offline (Offline): I tasti della tastiera a membrana sono di nuovo attivi, ma i dati ricevuti non vengono più elaborati. La ricezione dei nuovi job di stampa avverrà nuovamente quando l'apparecchio sarà di nuovo in modalità Online.

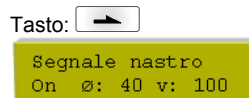
**Transfer ribbon prior warning (Segnale nastro = preallarme nastro di trasferimento):**

Se è stato attivata questa funzione, prima che il nastro di trasferimento finisca completamente, sarà attivato un segnale acustico.

Warning diameter (Diametro warning):

Impostazione del diametro di preallarme nastro di trasferimento.

Se a questo punto si imposta un valore in mm, quando il diametro del rotolo del nastro di trasferimento raggiungerà il valore impostato, verrà attivato un segnale acustico.

v = reduced speed (velocità di stampa ridotta):

Impostazione della velocità di stampa ridotta. Può essere impostata entro i valori della velocità di stampa normale. Inoltre è possibile effettuare le seguenti impostazioni:

-: Eliminazione della velocità di stampa ridotta

0: Al raggiungimento del diametro di preallarme, il modulo per la stampa diretta si arresta e viene segnalato un "errore del nastro di trasferimento".

Main Menu (Menu principale)

Dopo l'attivazione del modulo apparirà seguente avviso sul display:



<pre>* DC c107-12K * 14/09/05 10:16</pre>	<p>Prima riga = menu principale. Seconda riga = data ed orario odierni.</p>
<p>Tasto: <input type="radio"/></p>	
<pre>* DC c107-12K * V1.44</pre>	<p>Seconda riga = versione della Firmware.</p>
<p>Tasto: <input type="radio"/></p>	
<pre>* DC c107-12K * Build 0201</pre>	<p>Seconda riga = versione Build del software.</p>
<p>Tasto: <input type="radio"/></p>	
<pre>* DC c107-12K * Jun 2 2005</pre>	<p>Seconda riga = data di fabbricazione del Firmware.</p>
<p>Tasto: <input type="radio"/></p>	
<pre>* DC c107-12K * 10:37:34</pre>	<p>Seconda riga = ora della redazione del Firmware.</p>
<p>Tasto: <input type="radio"/></p>	
<pre>* DC c107-12K * E-Font: V5.01</pre>	<p>Seconda riga = versione dei bitmap fonts.</p>
<p>Tasto: <input type="radio"/></p>	
<pre>* DC c107-12K * V-Font: V1.01</pre>	<p>Seconda riga = versione dei fonts vettoriali.</p>
<p>Tasto: <input type="radio"/></p>	
<pre>* DC c107-12K * FPGA V1.4.0 T9</pre>	<p>Seconda riga = versione dei FPGA.</p>
<p>Tasto: <input type="radio"/></p>	
<pre>* DC c107-12K * 16 MB Memory</pre>	<p>Seconda riga = capacità di memoria espresso in MB.</p>
<p>Tasto: <input type="radio"/></p>	
<pre>* DC c107-12K * 8 MB FLASH</pre>	<p>Seconda riga = capacità di memoria del FLASH, espresso in MB.</p>
<p>Tasto: <input type="radio"/></p>	
<pre>* DC c107-12K * A0 MO V.1.3.1 AB</pre>	<p>Seconda riga = numero della versione del primo processore (alimentazione del motore).</p>
<p>Tasto: <input type="radio"/></p>	
<pre>* DC c107-12K * A1 MO V.1.3.1 AB</pre>	<p>Seconda riga = numero della versione del secondo processore (alimentazione del motore).</p>
<p>Tasto: <input type="radio"/></p>	
<pre>* DC c107-12K * A2 IO V.1.3.1 AB</pre>	<p>Seconda riga = numero della versione del terzo processore (sorveglio I/O).</p>

CF Card (Carta Compact Flash)

Select layout (Selezionare layout)

Sequenza tasti: 



```
→layout01 0
A:\STANDARD
```

Premere i tasti  e  per selezionare il layout desiderato nella directory STANDARD.
Premere il tasto  per selezionare il layout.

```
Druck Start
Anzahl: 12345
```

Selezionare il numero di layout da stampare.
Premere il tasto  per avviare il job di stampa.

Load file (Caricare file)



Sequenza tasti: , 

```
Funzioni CF
Caricare file
```

Tasto: 

```
□→ .. <
A:\STANDARD
```

Selezionare il file desiderato e confermare con .

Premere il tasto  e inserire il numero di pezzi da stampare desiderato. Confermare con , per avviare la stampa attraverso un segnale esterno (Input 1, PIN1 e PIN4).

Save layout (Memorizzare layout)

Sequenza tasti: , , 

```
Funzioni CF
Memorizzare lay.
```

Tasto: 

```
File esiste
sovrascrivere
```

Selezionare la directory o il layout che deve essere memorizzato e confermare con .

Confermare la richiesta (vedi in alto) con .

Save configuration (Memorizzare configurazione)

Sequenza tasti: , , , 

```
Funzioni CF
Memorizzare conf
```

Per difetto, il nome file proposto è config.cfg. L'utilizzatore può modificarlo. In questo file sono memorizzati i parametri della stampante che non registrati permanentemente nella Flash interna.

Premere il tasto  per avviare l'operazione di memorizzazione.

Change directory (Cambiare repertorio)

Sequenza tasti: , , , , 

```
Funzioni CF
Cambiare repert.
```

Tasto: 

```
←<.> M
A:\STANDARD\
```

Nella riga inferiore viene visualizzato la directory attualmente selezionata.

Premere i tasti  e  per cambiare la directory nella riga superiore.

Premere i tasti  e  per visualizzare le directories possibili.

Premere il tasto  per applicare la directory selezionata.

Delete file (Cancellare file)

Sequenza tasti: , , , , , 

Funzioni CF
Cancella file

Selezionare la directory o il layout che deve essere cancellato e confermare con .



Format CF card (Formattare CF card)

Sequenza tasti: , , , , , , 

Funzioni CF
Formattare

Taste: 

Formattare A:

Scegliere l'unità che deve essere formattata con il tasto . Confermare con il tasto . Durante la formattazione si crea automaticamente la directory STANDARD.

Free memory space (Visualizzare memoria libera)

Sequenza tasti: , , , , , , , 

Funzioni CF
Memoria libera

Visualizza la memoria libera della Compact Flash card.

Dati tecnici

	Dynacode 53	Dynacode 107	Dynacode 128
Risoluzione	300 dpi	300 dpi	300 dpi
Velocità di stampa modo continuo modo intermittente	50 ... 800 mm/s 50 ... 600 mm/s	50 ... 600 mm/s 50 ... 600 mm/s	50 ... 450 mm/s 50 ... 600 mm/s
Velocità di ritiro	solo modo intermittente: mass. 600 mm/s		
Larghezza di stampa	53,3 mm	106,6 mm	128 mm
Mass. Lunghezza di stampa modo continuo modo intermittente	6000 mm 75 mm	3000 mm 75 mm	3000 mm 75 mm
Largh. di passaggio telaio	secondo richiesta cliente	secondo richiesta cliente	secondo richiesta cliente
Testina di stampa	Corner Type	Corner Type	Corner Type
Emissioni sonore (distanza di misura 1 m)			
Livello di potenza acustica medio	60 dB(A)	65 dB(A)	68 dB(A)
Nastro di trasferimento			
Colore	esterno / interno (opzione)	esterno / interno (opzione)	esterno / interno (opzione)
Mass. diametro della bobina	98 mm	82 mm	75 mm
Diametro del nucleo	25,4 mm / 1"	25,4 mm / 1"	25,4 mm / 1"
Mass. lunghezza	900 m	600 m	450 m
Mass. larghezza	55 mm	110 mm	130 mm
Dimensioni (lunghezza x altezza x profondità)			
Meccanica di stampa			
senza telaio	204 x 180 x 234 mm	204 x 180 x 290 mm	204 x 180 x 312 mm
con telaio	dipendente da larghezza di passaggio		
Elettronica di guida	240 x 125 x 332 mm set di cavi per collegare la meccanica 2,5 m		
Peso			
Meccanica di stampa	9,5 kg	11 kg	11,7 kg
Elettronica (incl. cavo)	5,5 kg	5,5 kg	5,5 kg
Elettronica			
Processore	High Speed 32 Bit		
Memoria di lavoro (RAM)	16 MB / 64 MB (su richiesta)		
Slot	per scheda Compact Flash Tipo I		
Batteria	per orologio in tempo reale (salvataggio dei dati in caso di scollegamento da rete elettrica)		
Segnale di avviso	Segnale acustico in caso di errore		
Interfacce			
Seriale	RS-232C (115.200 Baud)		
Parallela	Centronics		
Ethernet	10/100 Base T		
USB	1.1		
Dati di allacciamento			
Collegamento pneumatico	min. 6 bar asciutto ed essente d'olio		
Tensione nominale	110 ... 230 V / 50 ... 60 Hz		
Corrente nominale	230 V / 1,5 A - 110 V / 3 A		
Valores di sicurezza	230 V / 2 AT - 110 V / 4 AT		
Condizioni di esercizio			
Temperatura	5 ... 40 °C		
Umidità relativa	mass. 80% (non condensando)		

Pannello di controllo	
Tasti	Prova di stampa, menu funzioni, conteggio, scheda CF, avanzamento, invio, 4 x cursore
Display LCD	Display grafico 132 x 32 pixel retroilluminazione verde
Parametri	
	Data, ora, alternate impostazioni in 11 lingue (altre su richiesta) Parametri dell'apparecchio, interfacce, password, variabili
Controlli	
Interruzione stampa in caso di	Fine del nastro a trasferimento termico / Fine layout / Testina di stampa aperta
Stampa dello stato	Stampa delle impostazioni dell'apparecchio, come ad esempio resa, parametri di fotocellula, interfaccia e rete Stampa dei caratteri interni e di tutti i codici a barre supportati
Font	
Caratteri	6 caratteri bitmap 8 caratteri vettoriali / caratteri TrueType 6 caratteri proporzionali Altri caratteri su richiesta
Set di caratteri	Windows 1250 fino a 1257, DOS 437, 850, 852, 857 Sono supportati tutti i caratteri dell'Europa occidentale e orientale, latini, cirillici, greci e arabi (opzione) Altri set di caratteri su richiesta
Caratteri bitmap	Dimensioni in larghezza e altezza 0,8 ... 5,6 Fattore di ingrandimento 2 ... 9 Orientamento 0°, 90°, 180°, 270°
Caratteri vettoriali / Caratteri TrueType	Dimensioni in larghezza e altezza 1 ... 99 mm Fattore di ingrandimento continuo. Orientamento 0°, 90°, 180°, 270°
Attributi caratteri	Dipendenti dal tipo di carattere grassetto, corsivo, inverso, verticale
Passo dei caratteri	Variabile
Codici a barre	
Codici a barre 1D	CODABAR, Code 128, Code 2/5 interleaved, Code 39, Code 39 extended, Code 93, EAN 13, EAN 8, EAN ADD ON, GS1-128, Identcode, ITF 14, Leitcode, Pharmacode, PZN 7 Code, PZN 8 Code, UPC-A, UPC-E
Codici a barre 2D	Aztec Code, CODABLOCK F, DataMatrix, GS1 DataMatrix, MAXICODE, PDF 417, QR Code
Codici composti	GS1 DataBar Expanded, GS1 DataBar Limited, GS1 DataBar Omnidirectional, GS1 DataBar Stacked, GS1 DataBar Stacked Omnidirectional, GS1 DataBar Truncated
	Tutti i codici a barre sono diversi per altezza, larghezza del modulo e rapporto Orientamento 0°, 90°, 180°, 270° A scelta cifra di controllo e stampa in caratteri ottici
Software	
Configurazione	ConfigTool
Controllo di processo	NiceLabel
Software	Labelstar Office Lite Labelstar Office
Windows driver	Windows XP® 32/64 Bit, Windows Vista® 32/64 Bit Windows 7® 32/64 Bit, Windows 8® 32/64 Bit Windows 8.1® 32/64 Bit, Windows Server 2003® (R2) 32/64 Bit Windows Server 2008® 32/64 Bit, Windows Server 2008® (R2) 64 Bit Windows Server 2012® 64 Bit, Windows Server 2012® (R2) 64 Bit

Ci si riserva il diritto di apportare in qualunque momento eventuali modifiche tecniche

Pulizia e manutenzione



PERICOLO!

Pericolo di morte per scarica elettrica!

⇒ Prima di effettuare qualsiasi operazione di manutenzione, separare il modulo dalla rete elettrica.

Pulizia della testina di stampa



AVVISO!

Per la pulizia dell'apparecchio, sono consigliati dispositivi di protezione personale, come occhiali protettivi e guanti.

Durante la stampa la testina di stampa si sporca, perciò è necessario pulirla in intervalli regolari. La regolazione della pulizia dipende dalle ore di esercizio, dall'ambiente p.e. polveroso ecc.



ATTENZIONE!

Danneggiamento della testina di stampa!

⇒ Per la pulizia della testina di stampa, non utilizzare oggetti affilati o acuminati.
⇒ Non toccare lo strato di vetro protettivo della testina di stampa.

- Rimuovere la cassetta del nastro di trasferimento.
- Pulire la superficie della testina di stampa con un pennino speciale per pulizia o un bastoncino d'ovatta imbevuto d'alcol.
- Prima di rimettere in servizio il modulo, lasciar asciugare la testina di stampa per 2 - 3 minuti.



AVVISO!

Devono essere osservate le norme per l'uso di isopropanolo (IPA). In caso di contatto con la pelle o con gli occhi, risciacquare bene con acqua corrente. In caso di irritazione persistente, contattare un medico. Assicurarsi che vi sia una aerazione sufficiente.

Sostituire la testina di stampa



ATTENZIONE!

Danneggiamento della testina di stampa dovuta a scariche elettrostatiche o ad agenti meccanici!

⇒ Il modulo deve essere posizionato su una base conduttiva messo a terra.
⇒ Mettetevi a terra in modo adatto (p.e. cintura intorno al polso).
⇒ Non toccare i contatti della testina con le mani.
⇒ Non toccare il listello di stampa con oggetti duri o con le mani.

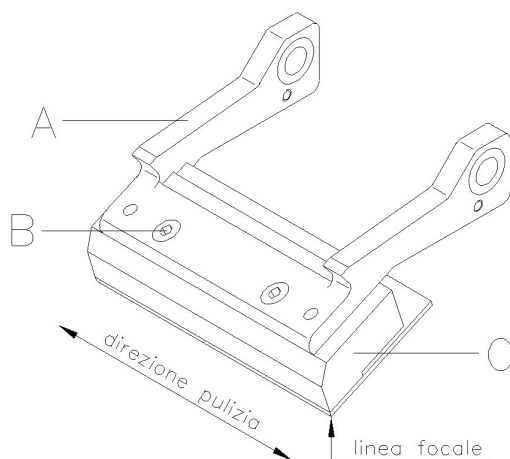

Smontare la testina di stampa

- Rimuovere la cassetta di nastro di trasferimento.
- Spingere l'unità testina di stampa nella posizione adeguata per la manutenzione.
- Spingere leggermente il supporto della testina di stampa (A) verso il basso affinché si possa inserire la chiave a brugola (SW 2,5) nelle viti (B).
- Rimuovere le viti (B) e estrarre la testina di stampa (C).
- Scollegare i connettori sulla testina di stampa.

Montare la testina di stampa

- Collegare i connettori.
- Posizionare la testina di stampa nel relativo supporto (A) in modo che le pinze si inseriscano nei fori adeguati nel supporto testina di stampa (A).
- Con un dito, tenere il supporto testina di stampa (A) sul cilindro di stampa senza premere e controllare che la testina di stampa (C) sia posizionata correttamente.
- Con la chiave esagonale avvitare e serrare la vite (B).
- Reinserire la cassetta di nastro di trasferimento.
- Inserire il valore di resistenza, che si trova sulla targhetta della testina di stampa, nel sotto-menu delle 'Funzioni d'assistenza/Resistenza Dot' (menu funzioni).
- Controllare la posizione della testina di stampa lanciando una prova di stampa.

Regolamento dell'angolo (modo intermittente)

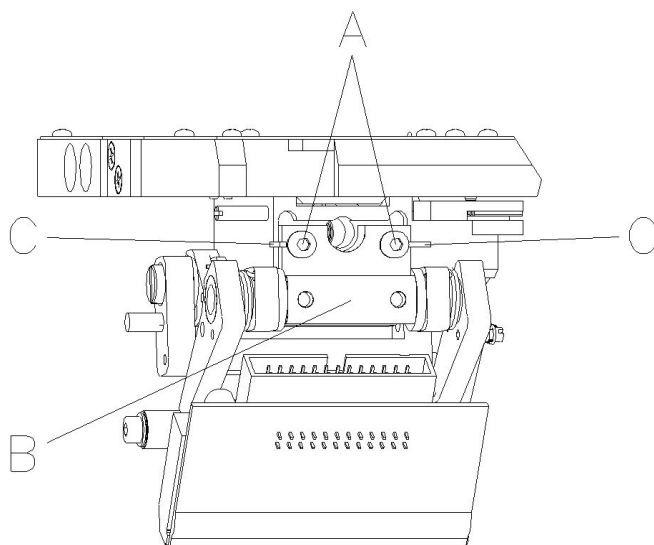

La distanza angolare tra testina di stampa e area di stampa è 26° (standard). A causa di deviazioni angolari causati, nella produzione della testina di stampa e la meccanica, certe volte è necessario irregolare l'angolo.



ATTENZIONE!

Danneggiamento della testina di stampa dovuto ad un'usura irregolare!
 Una maggiore usura del nastro di trasferimento dovuto ad uno sfilacciamento più rapido.
 => Modificare l'impostazione fabbrica solo in casi eccezionali.

- Allentare leggermente le viti a testa concava esagonale (A).
- Spostare l'elemento di posizionamento (B) per regolare l'angolo fra la testina di stampa e il supporto della testina di stampa. Spinta verso il basso = Riduzione dell'angolo
- Spinta verso l'alto = Ingrandimento dell'angolo
- Avvitare le vite a esagono cavo (A).
- Lanciare una stampa di 2 – 3 layout per controllare il cammino del nastro.



AVVISO!

Le fessure presenti (C) permettono di controllare il posizionamento. Attenersi se possibile ad una regolazione parallela.

Guia rápida e informações sobre
a segurança do produto

Português

Copyright: Carl Valentin GmbH.

Informações sobre o conteúdo do fornecimento, aspecto, capacidades, medidas e pesos correspondem às do nosso conhecimento na altura de impressão.

Reserva-se o direito de alterações.

Nenhuma parte da presente obra pode ser reproduzida (impressão, fotocópia ou outro método) sem a autorização por escrita da Carl Valentin GmbH, nem processada, multiplicada ou distribuída utilizando sistemas electrónicos.

Podem surgir divergências entre a documentação e o aparelho devido ao seu constante desenvolvimento.

Pode consultar a edição actual na página www.carl-valentin.de.

Marca registada

Todas as marcas ou marcas comerciais mencionadas são marcas registadas ou marcas comerciais registadas dos respectivos proprietários e podem não ser identificadas em separado. A ausência da identificação não permite pressupor que não se trate de uma marca ou marca comercial registada.

Os módulos de impressão Carl Valentin cumprem as seguintes directivas sobre segurança:

- CE** Directiva europeia das máquinas (98/37/CE)
- Directiva europeia de baixa tensão (2006/95/CE)
- Directiva europeia da Compatibilidade Electromagnética da CE (89/336/CEE)



Carl Valentin GmbH

Postfach 3744
78026 Villingen-Schwenningen
Neckarstraße 78 – 86 u. 94
78056 Villingen-Schwenningen

Phone +49 (0)7720 9712-0
Fax +49 (0)7720 9712-9901

E-Mail info@carl-valentin.de
Internet www.carl-valentin.de

Conteúdo

Utilização correcta	148
Instruções de segurança	148
Descarte ecológico	149
Requisitos operacionais	150
Desembalar o módulo de impressão directa	153
Conteúdo	153
Ligar o módulo de impressão directa	153
Preparação para a colocação em funcionamento	153
Accionamento da impressão	153
Colocação em funcionamento do módulo de impressão directa	153
Colocar uma fita de transferência	154
Print Settings (Inicialização da impressão)	155
Machine Parameters (Parâmetros da máquina)	155
Layout Parameters (Disposição)	156
Ribbon Save (Optimização) - Modo contínuo	157
Ribbon Save (Optimização) - Modo intermitente	159
Device Settings (Parâmetros do aparelho)	160
I/O Parameters (I/O Parâmetros)	161
Network (Rede)	161
Remote Console (Consola remota)	161
Interface (Interfaces)	162
Emulation (Simulação)	162
Date & Time (Data & Hora)	163
Service Functions (Funções de serviço)	164
Main Menu (Menu inicial)	166
Cartão Flash compacto	167
Especificações técnicas	169
Limpar a cabeça de impressão	171
Substituir a cabeça de impressão	171
Ajuste do ângulo (modo intermitente)	172

Utilização correcta

- O módulo de impressão directa foi construído de acordo com o estado actual da tecnologia e as regras de segurança técnica aprovadas. Todavia, a sua utilização poderá apresentar perigos para a vida e saúde do utilizador ou de terceiros ou causar danos no módulo de impressão directa e outros danos materiais.
- O módulo de impressão directa só pode ser utilizado em bom estado técnico, bem como conforme à finalidade prevista, sob consideração dos requisitos de segurança e dos perigos e sob observação das instruções de utilização. Nomeadamente avarias que possam comprometer a segurança devem ser imediatamente resolvidas.
- O módulo de impressão directa destina-se exclusivamente a impressão de material adequado e autorizado pelo fabricante. Qualquer outro tipo de utilização ou além do exposto é considerada uma utilização inadequada. O fabricante não se responsabiliza pelos danos resultantes da utilização inadequada, a responsabilidade é exclusivamente do utilizador.
- A utilização correcta engloba também a observação das instruções de utilização, inclusive das prescrições e recomendações de manutenção do fabricante.

Instruções de segurança

- O módulo de impressão directa foi concebido para redes de uma tensão alternada de 110-230 V. O módulo de impressão directa deve ser ligada apenas à tomadas com condutor de protecção (PE).



AVISO!

Em alterações na tensão de rede deve-se adaptar o valor de fusível correspondentemente (ver 'Especificações técnicas').

- O módulo de impressão directa deve ser ligado apenas a aparelhos sob tensão baixa de protecção.
- Antes de estabelecer ou desconectar ligações, todos os aparelhos envolvidos (computador, impressora, acessórios) devem ser desligados.
- O módulo de impressão directa apenas deve ser utilizado em ambientes secos e não deve ser sujeito a humidade (água de salpico, neblinas, etc.).
- Não operar os módulos de impressão directa em ambientes de risco de explosão e nem na proximidade de linhas de alta tensão.
- Colocar o aparelho em funcionamento apenas em espaços protegidos contra serragem, limalhas metálicas e corpos estranhos semelhantes.
- Se o módulo de impressão directa for utilizado com a tampa aberta, deve ser observado, que o vestuário, cabelos e jóias ou peças semelhantes das pessoas não possam entrar em contacto com as partes rotativas descobertas.



AVISO!

Com a unidade de impressão aberta não são respeitados os requisitos da EN60950-1 relativamente a caixa com protecção contra incêndio. Estes devem ser garantidos através da integração no aparelho final.

- Durante a impressão é possível que o módulo de impressão aqueça. Durante o funcionamento não deve portanto tocar-se no mesmo, sendo que antes de substituição de material, desmontagens ou ajustes terá de deixar-se arrefecer.
- Apenas são permitidos os trabalhos e intervenções descritos nas instruções de utilização. Os trabalhos que excedam esse âmbito devem ser executados apenas pelo fabricante ou mediante consulta do mesmo.
- Intervenções incorrectas em componentes electrónicos e respectivos softwares podem causar avarias.
- Trabalhos incorrectos ou alterações no aparelho podem ameaçar a segurança de funcionamento.
- Os trabalhos de assistência devem ser sempre efectuados numa oficina qualificada que possui as ferramentas e os conhecimentos técnicos necessários para efectuar os trabalhos relevantes.
- Estão colocadas várias indicações de aviso nos aparelhos, que alertam para os perigos. Não remover estes autocolantes, caso contrário os perigos deixam de estar identificados.
- O módulo de impressão directa deve ser integrado no circuito de paragem de emergência, caso seja montado na máquina completa.
- Antes de colocar a máquina em funcionamento, devem ser acrescentados todos os dispositivos de protecção de separação.



PERIGO!

Perigo de vida devido à tensão de rede!

⇒ Não abra a caixa do aparelho.

Descarte ecológico

Os fabricantes de aparelhos B2B encontram-se obrigados, a partir de 23.03.2006, a aceitar a devolução e a reaproveitarem aparelhos usados fabricados após 13.08.2005. Por princípio, estes aparelhos usados não podem ser entregues em locais de recolha municipais. Estes apenas podem ser reaproveitados e eliminados por parte do fabricante. Assim, os produtos identificados como sendo produtos da Valentin poderão, no futuro, ser remetidos à Carl Valentin GmbH.

Os aparelhos usados serão assim processados de forma correcta.

Desta forma, a Carl Valentin GmbH cumpre com todas as obrigações respeitantes à eliminação de aparelhos usados, possibilitando desta forma também uma venda dos seus produtos sem problemas. Apenas poderemos aceitar aparelhos enviados com as despesas de transporte pagas antecipadamente.

Para mais informações, consulte a diretiva REEE ou a nossa página Internet www.carl-valentin.de.

Requisitos operacionais

Os requisitos operacionais são condições prévias que devem ser asseguradas antes da colocação em funcionamento ou a operação dos nossos aparelhos e para assegurar uma operação segura e sem falhas.

Leia atentamente os Requisitos operacionais.

Caso tenha dúvidas em relação a implementação dos requisitos operacionais, contacte-nos ou contacte a assistência respectivamente responsável.

Requisitos gerais

Até a sua instalação, os aparelhos devem ser transportados e armazenados dentro da embalagem original.

Os aparelhos não devem ser instalados ou colocados em funcionamento se os requisitos operacionais não estiverem satisfeitos.

A colocação em funcionamento está interdita até que seja confirmado que, desde que aplicável, a máquina onde a quase-máquina deve ser montada respeita as disposições da Directiva Máquinas 2006/42/CE.

A colocação em funcionamento, programação, operação, limpeza e conservação dos nossos aparelhos apenas devem ser realizadas após leitura atenta das nossas instruções.

Os aparelhos só podem ser utilizados por pessoal devidamente instruído.



AVISO!

Recomendamos que efectue regularmente formações.

O conteúdo das formações são os capítulos 'Condições de funcionamento', 'Colocar fita de transferência' e 'Limpeza e Manutenção'.

Estas informações aplicam-se também a aparelhos de terceiros fornecidos por nós.

Só podem ser utilizadas peças sobressalentes e de substituição originais.

Relativamente às peças de substituição/desgaste, contacte o fabricante.

Informações sobre a bateria de lítio

Para a bateria de lítio (Tipo CR 2032), instalada sobre a CPU da impressora, aplica-se a Directiva de baterias da RFA a qual prevê, que as baterias gastas devem ser colocadas nos recipientes de recolha de baterias nas superfícies comerciais e entregues na entidade de processamento de resíduos oficialmente reconhecida. Caso as baterias não estejam completamente descarregadas, será necessário colocá-las em curto-circuito. Se a impressora for posta fora de funcionamento, a bateria deve ser descartada separada da impressora.



PERIGO!

Perigo de vida devido a explosão!

⇒ Utilizar ferramentas não condutoras.

Requisitos ao local de instalação

O local de instalação deve ser plano e não sujeito a choques, vibrações e correntes de ar.

Os aparelhos devem ser dispostos de modo a permitir uma operação otimizada e um acesso fácil para fins de manutenção.

Instalação local da alimentação eléctrica

A instalação da alimentação eléctrica para a ligação dos nossos aparelhos deve corresponder aos regulamentos internacionais e prescrições daí derivadas. Entre estes contam-se principalmente as recomendações de uma das três seguintes comissões:

- Comissão Electrotécnica Internacional (IEC)
- Comissão Europeia de Normalização Electrotécnica (CENELEC)
- Associação dos Electrotécnicos Alemães (VDE)

Os nossos aparelhos foram construídos de acordo com a classe de protecção I da VDE e devem ser ligados a um condutor de protecção. A instalação local de alimentação eléctrica deve possuir um condutor de protecção para conduzir as tensões de falha internas do aparelho.

Características técnicas da alimentação eléctrica

Tensão de rede e frequência:	Veja a placa de tipo
Tolerâncias admissíveis da tensão de rede:	+6% até -10% do valor nominal
Tolerâncias admissíveis da frequência de rede:	+2% até -2% do valor nominal
Factor de ruído admissível da tensão de rede:	<=5%

Medidas de resolução de interferências:

Em redes com problemas graves de interferências (p.ex. devido a utilização de sistemas de comando de tiristores) é necessário implementar no local medidas de resolução de interferências. Existem, p.ex., as seguintes opções:

- Instalação de cabos de alimentação próprios aos nossos aparelhos.
- Em casos mais problemáticos, montar no cabo de alimentação e à frente dos nossos aparelhos um transformador separador capacitativamente desacoplado ou um outro aparelho de eliminação de interferências.

Interferências e resistência contra perturbações

Interferências/emissões conforme EN 61000-6-4: 08-2002

- Tensão parasita em ligações conforme EN 55022: 09-2003
- Intensidade do campo perturbador conforme EN 55022: 09-2003
- Correntes harmónicas (retro alimentação à rede) segundo a directiva EN 61000-3-2: 09-2005
- Flutuação de tensão segundo a directiva EN 61000-3-3: 05-2002

Resistência contra interferências/imunidade conforme EN 61000-6-2: 03-2006

- Resistência contra descargas de electricidade estática conforme EN 61000-4-2: 12-2001
- Campos electromagnéticos conforme EN 61000-4-3: 11-2003
- Resistência contra descargas eléctricas rápidas (burst) conforme EN 61000-4-4: 07-2005
- Resistência contra sobrecargas de tensão (surge) conforme EN 61000-4-5: 12-2001
- Tensões de alta-frequência conforme EN 61000-4-6: 12-2001
- Interrupções e variações de tensão conforme EN 61000-4-11: 02-2005



AVISO!

Este é um dispositivo da classe A; Este dispositivo pode causar falhas no ambiente doméstico; neste caso, pode ser exigida ao proprietário a execução de medidas a isso apropriadas e a responsabilização pelos acontecimentos.

Segurança de máquinas

- EN 415-2 – Segurança de máquinas de embalagem
- EN 60204-1:2006 – Segurança de máquinas – Equipamento eléctrico de máquinas – Parte 1

Cabos de ligação aos aparelhos externos

Todos cabos de ligação devem apresentar condutores blindados. Em ambas as extremidades, o tecido de blindagem deve ser ligado em grande superfície com o corpo da ficha.

Outros cabos não devem ser estendidos em paralelo aos cabos de alimentação eléctrica. Em casos em que a condução dos cabos em paralelo for inevitável deve ser mantida uma distância mínima de 0,5 m.

Gama de temperaturas dos cabos: -15 até +80 °C.

Somente devem ser ligados aparelhos cujos circuitos eléctricos obedecem aos requisitos da 'Safety Extra Low Voltage' (SELV). Em geral, estes aparelhos são verificados em conformidade com a EN 60950.

Instalação dos cabos de dados

Os cabos de dados devem estar completamente blindados e estar equipados com fichas de conexão de metal ou metalizadas. Cabos e fichas blindados são necessários para evitar a emissão ou recepção de interferências electromagnéticas.

Cabos admissíveis

Cabo blindado: 4 x 2 x 0,14 mm² (4 x 2 x AWG 26)
 6 x 2 x 0,14 mm² (6 x 2 x AWG 26)
 12 x 2 x 0,14 mm² (12 x 2 x AWG 26)

Os cabos de emissão e de recepção devem ser respectivamente constituídos por pares entrelaçados.

Comprimento máximo dos cabos: com interface V 24 (RS232C) - 15 m para um máximo de 19200 bds
 com Centronics - 3 m
 com USB - 3 m
 com Ethernet - 100 m

Circulação de ar

Para evitar um aquecimento inadmissível deve existir uma circulação adequada de ar em torno do aparelho.

Valores limite

Classe de protecção conforme IP:	20
Temperatura de ambiente °C (funcionamento):	mín. +5 máx. +40
Temperatura de ambiente °C (transporte, armazenagem):	mín. -25 máx. +60
Humidade relativa do ar % (funcionamento):	no máx. 80
Humidade relativa do ar % (transporte, armazenagem):	no máx. 80 (condensação no aparelho não permitida)

Garantia

Não nos responsabilizamos por danos que possam ser causados por:

- Incumprimento dos requisitos operacionais ou das instruções de utilização
- Instalação eléctrica local deficiente.
- Modificação construtiva dos nossos aparelhos.
- Programação ou utilização errada.
- Omissão da segurança de dados.
- Utilização de peças e acessórios não originais.
- Desgaste natural.

Ao preparar ou reprogramar aparelhos, deve verificar os ajustes novos através de um ensaio funcional ou uma impressão de teste. Desta forma evita resultados, marcas de impressão e análises deficientes.

Os aparelhos só podem ser utilizados por funcionários devidamente instruídos.

Controle o manuseamento correcto dos nossos produtos e repita as acções de formação.

Não podemos garantir, que todas as características descritas nas presentes instruções se encontram implementadas em todos os modelos. Devido ao nosso esforço de um desenvolvimento e melhoramento contínuo, existe a possibilidade de alterações nas características técnicas, sem que estas sejam anunciadas.

Devido ao desenvolvimento ou prescrições nacionais específicas de cada país, as imagens e exemplos constantes nas instruções podem divergir do modelo fornecido.

Para evitar danos ou um desgaste prematuro, observe as informações sobre os meios de impressão admissíveis e as instruções sobre a conservação do aparelho.

Fizemos todos os esforços para editar este manual de forma compreensiva, e para lhe dar o máximo de informação possível. Em caso de dúvidas ou de encontrar erros, por favor informe-nos sobre o mesmo, para nos possibilitar o melhoramento dos nossos manuais.

Desembalar o módulo de impressão directa

- ⇒ Retirar o módulo de impressão directa do cartão.
- ⇒ Verificar se o módulo de impressão directa apresenta devidos ao transporte.
- ⇒ Verificar o fornecimento quanto à sua integridade.

Conteúdo

- Mecânica de impressão
- Electrónica de controlo
- Cabo de rede
- Cabo de ligação (sensores, potência)
- Mini-regulador
- Manómetro
- Mangueira pneumática
- Roscagens
- Acessórios I/O (contra-ficha para I/Os, cabo I/O 24)
- 1 Rolo de fita de transferência
- Rolo de cartão (vazio), pré-montado numa bobina de fita de transferência
- Película de limpeza para a cabeça
- Documentação
- CD com os drivers da impressora



AVISO!

Conserve a embalagem original para o transporte posterior.

Ligar o módulo de impressão directa

O módulo está equipado com uma peça de rede de longo alcance. O funcionamento com uma tensão de rede de 110-230 V / 50-60 Hz é possível sem intervenções no aparelho.



CUIDADO!

Perigo de danos no aparelho devido a correntes de arranque indefinidas.

- ⇒ Antes da ligação à rede, coloque o interruptor principal na posição 'O'.
- ⇒ Insira o cabo de rede na tomada de alimentação.
- ⇒ Ligue o cabo de rede a uma tomada com ligação à terra.



AVISO!

Uma ligação à terra inexistente ou deficiente pode causar avarias durante o funcionamento. Certifique-se de que todos os computadores ligados à impressora de etiquetas, bem como os cabos de ligação, estão ligados à terra.

- ⇒ Ligue o módulo de impressão directa ao computador ou à rede utilizando um cabo adequado.

Preparação para a colocação em funcionamento

- ⇒ Montar a estrutura mecânica de impressão.
- ⇒ Ligar à tomada o cabo de ligação entre a estrutura mecânica de impressão e a electrónica de accionamento, impedindo-o de se soltar inadvertidamente.
- ⇒ Ligar a tubagem de ar comprimido.
- ⇒ Estabelecer a ligação entre a electrónica de accionamento e o computador, por meio de portas de impressão.
- ⇒ Estabelecer a ligação entre a electrónica de accionamento e a máquina de embalagem, por meio de saídas de accionamento.
- ⇒ Ligar o cabo de rede da electrónica de accionamento.

Accionamento da impressão

Visto que o módulo de impressão directa se encontra sempre no modo de controlo, as tarefas de impressão poderão ser transmitidas apenas por meio das portas de impressão existentes (em série, paralelas, por meio de USB ou eventualmente Ethernet), não podendo contudo ser iniciadas. A impressão é iniciada por meio de um sinal de arranque sobre a entrada para o início da impressão. Para que a electrónica de accionamento reconheça quando é que o sinal de arranque pode ser accionado, é possível e na maioria das vezes é necessário que seja feito o seguimento do estado da impressão por meio das entradas.

Colocação em funcionamento do módulo de impressão directa

Depois de estabelecer todas as ligações:

- ⇒ Tras conectar el aparato aparecerá en la pantalla el menú principal, y se mostrarán el tipo del módulo y la hora y fecha actuales.
- ⇒ Inserción del casete de la cinta de transferencia. Tras insertar el casete de la cinta de transferencia se procederá a medir la cinta de transferencia introducida y el cabezal de impresión se situará en posición de impresión.

Colocar cassete de fita de transferência



AVISO!

Dado que a descarga electrostática pode danificar a fina camada de revestimento da cabeça de impressão de transferência térmica ou outros componentes electrónicos, a fita de transferência deverá ser do tipo anti-estático. A utilização de materiais errados pode causar mau funcionamento do sistema de impressão directa ou inviabilizar a garantia.

Fita de transferência enrolada por fora



AVISO!

Antes de colocar um rolo de fita de transferência novo, deve-se limpar a cabeça de impressão com agente de limpeza para cabeças de impressão e de tambores (97.20.002).

Devem ser respeitadas as normas de manuseamento para utilização de Isopropanol (IPA). Em caso de contacto com a pele ou os olhos lavar bem sob água corrente. Em caso de irritações permanentes consultar o médico. Garantir uma boa ventilação.

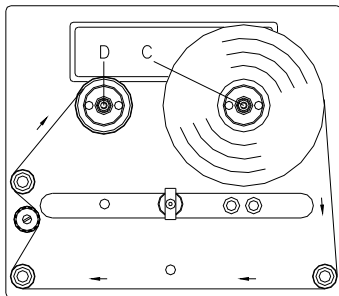
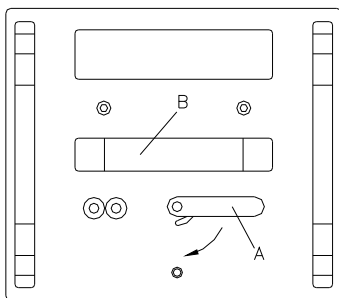

A ilustração apresenta um sistema de impressão do lado esquerdo. No caso de um sistema de impressão do lado direito, o novo rolo deverá ser colocado do lado esquerdo e o núcleo de cartão do lado direito.

- Rodar a alavanca (A) em 90° no sentido horário.
- Retirar a película de transferência da estrutura mecânica de impressão puxando na pega (B).
- Colocar o novo carretel de fita (A) sobre o dispositivo de enrolamento (C) até ao batente.
- Colocar o tubo de cartão vazio sobre o dispositivo de enrolamento (D) até ao batente.
- Colocar a película de transferência de acordo com a ilustração.
- Colar a película de transferência ao tubo vazio de papel com o auxílio de um pouco de fita-cola e apertá-lo ao tubo, rodando algumas vezes.
- Voltar a empurrar a película de transferência sobre a estrutura de impressão e ter em atenção que a película de transferência não rasgue durante esse processo.
- Rodar a alavanca (A) em 90° no sentido anti-horário.

Fita de transferência enrolada por dentro

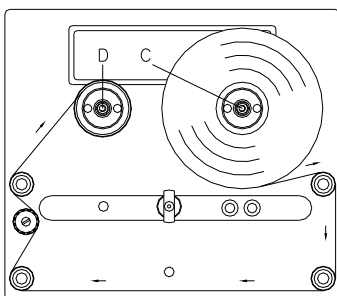
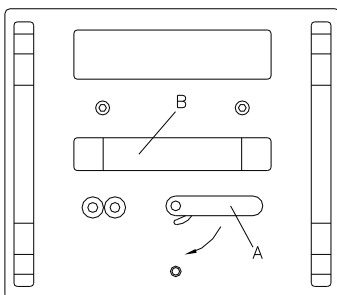

A ilustração apresenta um sistema de impressão do lado esquerdo. No caso de um sistema de impressão do lado direito, o novo rolo deverá ser colocado do lado esquerdo e o núcleo de cartão do lado direito.

- Rodar a alavanca (A) em 90° no sentido horário.
- Retirar a película de transferência da estrutura mecânica de impressão puxando na pega (B).
- Colocar o novo carretel de fita (A) sobre o dispositivo de enrolamento (C) até ao batente.
- Colocar o tubo de cartão vazio sobre o dispositivo de enrolamento (D) até ao batente.
- Colocar a película de transferência de acordo com a ilustração.
- Colar a película de transferência ao tubo vazio de papel com o auxílio de um pouco de fita-cola e apertá-lo ao tubo, rodando algumas vezes.
- Voltar a empurrar a película de transferência sobre a estrutura de impressão e ter em atenção que a película de transferência não rasgue durante esse processo.
- Rodar a alavanca (A) em 90° no sentido anti-horário.

Print Settings (Inicialização da impressão)

Sequência de teclas: **F**

Menú de funções
Inicialização

Tecla:

Modo contínuo

Potência térmica
(%) 100

Contrast (Potência térmica)

Gama de valores: 10% ... 200%.

Modo intermitente

Velocidade: 100
Pot. térmica: 100

Speed (Velocidade):

Gama de valores: 50 mm/s ... 200 mm/s.

Contrast (Potência térmica):

Gama de valores: 10% ... 200%.

Tecla:

Monitorização FT
ON sens. elevada

Transfer ribbon control (Monitorização da fita de transferência):

Off (Desligado): A monitorização da fita de transferência está desligada.

On (Ligado): A monitorização da fita de transferência está ligada.

strong sensibility (Elevada sensibilidade): A impressora reage imediatamente ao chegar ao fim da fita de transferência.

weak sensibility (Baixa sensibilidade): A impressora reage em cerca de 1/3 mais lenta ao fim da fita de transferência.

Tecla:

Desvio X
Offs (mm): -1.5

X-displacement (Desvio X):

Introdução do desvio no sentido X.

Gama de valores: -90.0 ... +90.0

Machine Parameters (Parâmetros da máquina)

Modo contínuo

Sequência de teclas: **F**,

Menú de funções
Parâm. máquina

Tecla:

Modo
IO DY

Operating mode (Modo):

Seleção do modo operacional.

Tecla:

Impressão Offset
(mm) 0.3

Print offset (Impressão Offset):

Distância da disposição para o centro neutro da máquina

Campo de valores: 1 ... 999 mm

Tecla:

Posição impres.
(mm) 20.0

Print position (Posição de impressão):

Indicação da posição inicial do carro de impressão em mm.

Campo de valores: 12 ... 93 mm

Tecla:

Disposição/ciclo
1

Layouts/cycle (Disposições/ciclos):

Indicação dos processos de impressão por comprimento de impressão.

Campo de valores: 1 ... 25 disposições por ciclo

Modo intermitente

Sequência de teclas: **F**,

Menú de funções
Parâm. máquina

Tecla:

Modo
2 Contínuo

Operating mode (Modo):

Seleção do modo operacional.

Tecla:

Vel. retorno mm/s
400

Back speed (Velocidade de retorno):

Indicação da velocidade de retorno da mecânica de

impressão depois do fim da impressão em mm/s.

Campo de valores: 50 ... 600 mm/s.

Tecla:

Impressão Offset
(mm) 0.0

Print offset (Impressão Offset):

Distância da disposição para o centro neutro da máquina

Campo de valores: 1 ... 999 mm

Tecla:

Posição impres.
(mm) 20.0

Print position (Posição de impressão):

Indicação da posição inicial do carro de impressão em mm.

Campo de valores: 12 ... 93 mm

Modo contínuoTecla: 

```
ChkSpeed On Strt
                Off
```

Check speed on start (verificar velocidade de material no início da impressão):

Verifica a velocidade do material aquando do sinal de arranque da impressão.

Tecla: 

```
Res.   mm/360°
2000   166
```

Encoder resolution / material feed per encoder rotation (Resolução do codificador / entrada de material por rotações):

Indicação da resolução do codificador utilizado e alimentação do material por rotação do codificador em mm

Tecla: 

```
Veloc. material
200 mm/s
```

Material speed (Velocidade do material):

Indicação da velocidade definida do material de impressão.

Modo intermitenteTecla: 

```
Disposição/ciclo
1
```

Layouts/cycle (Disposições/ciclos):

Indicação dos processos de impressão por comprimento de impressão.

Campo de valores: 1 ... 25 disposições por ciclo

Layout Parameters (Disposição)Sequência de teclas: **F** , 

```
Menú funções
Disposição
```

Tecla: 

```
Comp. impr. (mm)
140.0
```

Tecla: 

```
Largura:      20.0
Quant. colunas: 4
```

Tecla: 

```
Material
Tipo 1
```

Tecla: 

```
Espelhar dispos.
Liqado
```

Tecla: 

```
Rodar disposição
Desliqado
```

Tecla: 

```
Alinhamento
Esquerda
```

Print length (Comprimento de impressão):

Indicação do caminho que a mecânica de impressão deve percorrer.

Column printing (Largura das disposição / quantidade de colunas):

Indicação da largura de uma disposição, bem como a indicação da quantidade das disposições que se encontram lado a lado no material de suporte.

Material selection (Escolha do material):

Escolha do material das etiquetas ou do material da fita de transferência.

Flip layout (Espelhar disposição):

O eixo de espelhamento encontra-se no centro da disposição. Quando não tiver sido transmitida a largura da disposição à impressora, é utilizada a largura da disposição padrão, ou seja, a largura da cabeça de impressão. Por este motivo deve ter em atenção que a disposição seja da largura da cabeça de impressão. Caso contrário podem ocorrer problemas no posicionamento.

Rotate layout (Rodar disposição):

A disposição é devidamente impressa com saindo primeiro a parte de cima com uma rotação de 0°. Se a função é activada a disposição é rodada em 180° e impressa de forma a ficar na direcção de leitura.

Alignment (Alinhamento):

O alinhamento da disposição apenas se dá depois de se rodar/espelhar, ou seja, o alinhamento depende da rotação e do espelhamento.

Left (Esquerda): A disposição está alinhada o mais à esquerda possível da cabeça da impressão.

Centre (Centro): A disposição está alinhada no ponto central da cabeça de impressão.

Right (Direita): A disposição está alinhada o mais à direita possível da cabeça de impressão.

Ribbon Save (Optimização) - Modo contínuo

Sequência de teclas: **F**, , , 

Menú funções
Optimização

Tecla: 

Mode Speed
Standard 600

Operating mode (Modo de operação):

Seleção do tipo de optimização.

Off (Desligado): Optimização desligada.

Standard (Padrão): Potência máxima de optimização, i.e., com esta configuração não se verifica nenhuma perda da fita de transferência (à excepção de uma distância de segurança de 1 mm, para que os campos de impressão não sejam impressos um no outro).

SaveStrt (Guardar sinal de início): Sem perdas do sinal de início, o módulo de impressão directa regula automaticamente a qualidade de optimização conforme necessário.

Speed (Velocidade): Estabelecimento da velocidade máxima de impressão. Com base neste valor são efectuados todos os cálculos necessários.

Modo: Padrão

R-Correction
-1 mm

Transfer ribbon correction (Correcção da fita de transferência):

0 mm = Existe sempre um retrocesso de forma a alcançar-se a melhor optimização possível (sem perdas de película de transferência).

Defeito: 0 mm

-xx mm = O retrocesso pode ser diminuído.

+xx mm = O retrocesso pode ser aumentado.

Tecla: 

sa/mm cmin so/mm
303 1000 10

Performance information (Informação do desempenho):

sa/mm: A distância mínima possível entre duas impressões com a máxima optimização.

cmin: Número máximo de ciclos por minuto.

so/mm: Indicação da perda de optimização.

Tecla: 

ExpertParameters

Expert parameters (Parâmetros especializados)

Menu protegido com palavra-passe

Introduzir palavra-chave, premir o botão  e de seguida serão apresentados os parâmetros seguintes.

Tecla: 

PhDownT REstartT
30 ms 10 ms

PhDownT = Printhead down time in ms (Movimento descendente da cabeça em ms):

É calculado o movimento descendente da cabeça de impressão.

REstartT = Ribbon motor early start time in ms (Tempo de arranque precoce do motor em ms):

Este valor é adicionado ao tempo de aumento do movimento da fita de transferência.

Periodicidade para o tempo entre o "Motor alcança velocidade de material" e "Cabeça de impressão queima".

Tecla: 

MinSpeed Calcoff
50 mm/s On

MinSpeed = Minimal print speed (Velocidade mínima de impressão):

Se se aumentar a velocidade mínima de impressão também aumenta o número máximo de ciclos.

Calcoff = Print offset border calculation (Cálculo da margem do offset):

Se se colocar o parâmetro em "off" poderá introduzir-se um offset de impressão mais pequeno do que o necessário.

Tecla: 

PhUpT PhVReactT
20 ms 10 ms

PhUpT = Printhead up time in ms (Tempo de funcionamento da cabeça em ms):

Calcula se se pode fazer uma optimização do campo ou não.

PhVReactT = Printhead valve reaction time in ms (Tempo de reacção em ms):

Cálculo do início do movimento descendente da cabeça de impressão.

Tecla: 

RibMotStpDlayT
2 ms

RibMotStpDlayT = Ribbon motor stop delay time (Tempo de retardamento)

Tempo de retardamento em ms, no qual o motor da fita de transferência continua a funcionar com velocidade constante antes de parar.

Tecla: 

FieldRS	Rwind v
Normal	600mm/s

FieldRS = Field ribbon saving (Guardar o campo da fita):**Off:** Optimização de campo desligada**PHOnly:** Apenas se move a cabeça de impressão. A fita de transferência não se detém.**Normal:** A optimização do campo apenas é executada quando o motor da fita de transferência estiver completamente parado.**Strong:** É executada a optimização do campo, mesmo quando a fita de transferência do motor não estiver parada.**Rwind v = Rewind speed (Rebobinagem):**

Indicação da velocidade de rebobinagem em mm/s.

Tecla: 

Speed 1. Field
400 mm/s

Speed 1 field (Velocidade 1. Campo):

Se estiver definido o valor "0" (valor por defeito), o parâmetro não tem qualquer influência sobre a optimização.

Tecla: 

Tension
0 mm

Tension (Tensão):

Indicação do comprimento que é transportado para a frente após a medição da fita de transferência.

Modo: Shift

X-Shift	Y-Shift
10 mm	13 mm

X-Shift / Y-Shift (Desvio X / Desvio Y):**X-Shift (Desvio X):** Indicação do desvio da imagem de impressão no sentido X.**Y-Shift (Desvio Y):** Indicação do desvio no sentido da impressão.Tecla: 

Lanes	R-Shift
3	-5 mm

Lanes / R-Shift (Ciclos / Desvio R):**Lanes (Ciclos):** Indicação da quantidade de ciclos paralelamente impressos.**R-Shift (Desvio R):** Indicação da distância aquando da mudança para um novo ciclo.Tecla: 

ExpertParameters

Expert parameters (Parâmetros especializados):**Protegido por palavra-chave**Introduzir palavra-chave e premir o botão .

A descrição encontra-se em Modo "Standard".

Modo: SaveStrt

ExpertParameters

Expert parameters (Parâmetros especializados):**Protegido por palavra-chave**Introduzir palavra-chave e premir o botão .

A descrição encontra-se em Modo "Standard".

Ribbon Save (Optimização) - Modo intermitente

Sequência de teclas: **F**, , , 

Menú funções
Optimização

Tecla:

Mode
Standard

Operating mode (Modo de operação):

Seleção do tipo de optimização.

Off (Desligado): Optimização desligada.

Standard (Padrão): Potência máxima de optimização, i.e., com esta configuração não se verifica nenhuma perda da fita de transferência (à excepção de uma distância de segurança de 1 mm, para que os campos de impressão não sejam impressos um no outro).

Shift (Desvio): Os dados de esquema podem ser impressos repetidamente com um desvio lateral. Desta forma é possível alcançar o aproveitamento máximo da fita de transferência.

Modo: Padrão

R-Correction
-1 mm

Transfer ribbon correction (Correcção da fita de transferência):

0 mm = Existe sempre um retrocesso de forma a alcançar-se a melhor optimização possível (sem perdas de película de transferência).

Defeito: 0 mm

-xx mm = O retrocesso pode ser diminuído.

+xx mm = O retrocesso pode ser aumentado.

Tecla: 

ExpertParameters

Expert parameters (Parâmetros especializados):

Menu protegido com palavra-passe

Introduzir palavra-chave, premir o botão e de seguida serão apresentados os parâmetros seguintes.

Tecla: 

PhDownT PhUpT
35 ms 0 ms

PhDownT = Printhead down time in ms (Movimento descendente da cabeça em ms):

É calculado o movimento descendente da cabeça de impressão.

PhUpT = Printhead up time in ms (Tempo de funcionamento da cabeça em ms):

Calcula se se pode fazer uma optimização do campo ou não.

Tecla: 

PhVReactT
10 ms

PhVReactT = Printhead valve reaction time in ms (Tempo de reacção em ms):

Cálculo do início do movimento descendente da cabeça de impressão.

Tecla: 

Tension RM
0 mm 0

Tension (Tensão):

Indicação do comprimento que é transportado para a frente após a medição da fita de transferência.

Ribbon mode (Modo fita):

0: A fita de transferência é puxada para trás em todo o comprimento de impressão após cada impressão, ou seja, não existe qualquer optimização entre os esquemas individuais.

1: A fita de transferência é puxada para trás sobre a área impressa, ou seja, são optimizados os intervalos entre os esquemas.

A fita de transferência é automaticamente posicionada aquando de uma mudança de esquema.

Modo: Shift

X-Shift Y-Shift
10 mm 13 mm

X-Shift / Y-Shift (Desvio X / Desvio Y):

X-Shift (Desvio X): Indicação do desvio da imagem de impressão no sentido X.

Y-Shift (Desvio Y): Indicação do desvio no sentido da impressão.

Tecla: 

Lanes R-Shift
3 -5 mm

Lanes / R-Shift (Ciclos / Desvio R):

Lanes (Ciclos): Indicação da quantidade de ciclos paralelamente impressos.

R-Shift (Desvio R): Indicação da distância aquando da mudança para um novo ciclo.

Tecla: 

ExpertParameters

Expert parameters (Parâmetros especializados):

Protegido por palavra-chave

Introduzir palavra-chave e premir o botão .

A descrição encontra-se em Modo "Standard".

Device Settings (Parâmetros do aparelho)

Sequência de teclas: **F**, , , , 

Menú de funções
Parâmetros

Tecla: 

Gestão memória
OFF

Field handling (Gestão de memória):

Off (Desligado): Toda a memória de impressão será apagada.

Keep graphic (Conservar o gráfico): Um gráfico ou um tipo de letra TrueType será transferido uma vez para o módulo e guardado na memória interna do módulo. Para as tarefas seguintes de impressão já só serão transferidos para o módulo os dados alterados. A vantagem é a poupança no tempo de transmissão dos dados gráficos.

Delete graphic (Eliminar o gráfico): Os gráficos introduzidos na memória interna do módulo ou tipos de letra True Type serão apagados, os campos restantes serão, no entanto, mantidos.

Tecla: 

Codepage
GEM Deutsch

Codepage (Codepage):

Escolha do conjunto de caracteres a utilizar.

Tecla: 

Parâmetro ext.
On

External parameters (Parâmetro exterior):

Layout dimension only (Apenas dimensão do layout): Os parâmetros do comprimento do layout, espaço entre etiquetas e largura do layout podem ser transferidos. Todas as outras configurações de parâmetros devem ser efectuadas directamente no sistema de impressão.

On (Ligado): Os parâmetros podem ser transferidos para o módulo pelo nosso software de configuração de desenhos. Os parâmetros que antes tinham sido directamente introduzidos no módulo, não voltarão a ser tidos em conta.

Off (Desligado): Apenas serão consideradas as definições ajustadas directamente no módulo.

Tecla: 

Sinalizador
ON

Buzzer (Sinalizador acústico):

On (Ligado): Um sinal acústico é emitido ao premir qualquer Tecla.

Gama de valores: 1 ... 7

Off (Desligado): Não se houve qualquer sinal.

Tecla: 

Idioma
Português

Language (Idioma):

Escolha do idioma no qual os textos devem surgir no visor. Estão disponíveis as seguintes opções: alemão, inglês, francês, espanhol, português, neerlandês, italiano, dinamarquês, finlandês, polaco, checo e russo.

Tecla: 

Intr. Utilizador
On

Customized entry (Introdução do Utilizador):

On (Ligado): A consulta pelas variáveis de utilizador aparece uma vez no visor antes de iniciar a impressão.

Auto: A consulta pelas variáveis de utilizador aparece depois de cada disposição.

Off (Desligado): No ecrã não aparece qualquer solicitação das variáveis de utilizador. Neste caso é impresso o valor predefinido guardado.

Tecla: 

Arranque quente
Off

Hotstart (Arranque a quente):

On (Ligado): Uma tarefa de impressão pode ser retomada depois de voltar a ligar o módulo. (Apenas se o módulo estiver equipada com a opção do cartão CompactFlash).

Off (Desligado): Todos os dados serão perdidas depois de desligar o módulo.

Tecla: 

Palavra-passe
Activo

Password (Palavra-passe):

Através da palavra-passe podem ser bloqueadas diferentes funções para o utilizador.

Tecla: 

Confir. dispos.
On

Layout confirmation (Confirmação da disposição):

On (Ligado): Apenas é impressa uma nova tarefa de impressão após confirmação no aparelho.

Uma tarefa de impressão contínua já activa continua a ser impressa até que seja feita a confirmação no aparelho.

Off (Desligado): Não aparece qualquer consulta no visor do accionamento.

Tecla: Dispos. padrão
Ligado**Standard layout (Disposição padrão):**

On (Ligado): Se for iniciada uma tarefa de impressão sem que haja a definição prévia de uma disposição será impresso uma disposição padrão (tipo de equipamento, versão do Firmware, versão da compilação).

Off (Desligado): Se for iniciada uma tarefa de impressão sem que haja a definição prévia de uma disposição, irá aparecer uma mensagem de erro no visor.

I/O Parameters (I/O Parâmetros)Sequência de teclas: **F**, , , , , Menú de funções
I/O ParâmetrosTecla: Nível sinal IN
1s2x3+4x5x6x7x8x**IN signal level (Nível de sinal IN):**

Indicação do sinal com o qual é iniciado um trabalho de impressão.

+ = nível do sinal activo é 'high' (1)

- = nível do sinal activo é 'low' (0)

x = nível de sinal não activado

s = estado pode ser influenciado pela interface (am conjunto com a Netstar PLUS)

Tecla: Nível sinal OUT
1+2+3+4+5+6+7+8+**OUT signal level (Nível de sinal OUT):**

Indicação do nível de saída para o sinal de saída.

+ = nível do sinal activo é 'high' (1)

- = nível do sinal activo é 'low' (0)

s = estado pode ser influenciado pela interface (am conjunto com a Netstar PLUS)

Tecla: Debouncing (ms)
50**Debouncing (Desbloqueio):**

Indicação do tempo de debouncing da entrada do dispensador.

Intervalo de valores: 0 ... 100 ms.

Tecla: Retardamento (s)
1.00**Start signal delay (Retardamento do sinal de arranque):**

Indicação do tempo de retardamento com o qual é atrasado o início da impressão.

Intervalo de valores: 0.00 ... 9.99.

Tecla: ErrorIfNotReady
On**Error of not ready (Erro no caso de não estar pronta):**

On: No caso de uma tarefa de impressão se encontrar e se o módulo de impressão directa não estiver apto a processá-la (por já estar, por exemplo, no modo "impressão"), é emitida uma mensagem de erro.

Off: Não é emitida qualquer mensagem de erro.

Tecla: Pronto impressão
Off**Ready while printing (Pronto durante a impressão):**

Configuração, se o sinal de saída de "Pronto a imprimir" (Out 5, Output II) fica activo durante a impressão.

Off (Desligado): O sinal "Pronto a imprimir" fica inactivo aquando do início da impressão (configuração por defeito).

On (Ligado): O sinal "Pronto a imprimir" fica activo aquando do início da impressão.

Network (Rede)Sequência de teclas: **F**, , , , , , Menú de funções
Rede

Para obter mais informações, consulte o manual em separado.

Remote Console (Consola remota)Sequência de teclas: **F**, , , , , , , Menú de funções
Consola remota

Para obter informações deste ponto de menu dirija-se à nossa secção de distribuição.

Interface (Interface)

Sequência de teclas: **F**, , , , , , , , 

Menú de funções
Interfaces

Tecla:

COM1	Baud	P	D	S
0	9600	N	8	2

COM1:

0 - Interface de série desligada
1 - Interface de série ligada
2 - Interface de série ligada; não será mostrada qualquer mensagem de erro numa falha de transmissão

Baud (Baud):

Indicação dos bits transferidos por segundo.
Os seguintes valores podem ser escolhidos: 2400, 4800, 9600, 19200, 38400 e 115200.

P = Parity (Paridade):

N - sem paridade (no parity)
E - par (even)
O - ímpar (odd)

Deverá ter em atenção para que os ajustes estejam de acordo com os do módulo.

D = Data bits (Bits de dados):

Ajuste dos bits de dados. Pode escolher entre 7 ou 8 bits.

S = Stop bits (Bits de paragem):

Tem a possibilidade de escolher entre 1 ou 2 bits de paragem.
Indicação dos bits de paragem entre os bytes.

Tecla: 

Início (SOH): 01
Fim (ETB): 17

Start/stop sign (Sinal de Início/ Paragem):

SOH: Início do bloco de transmissão de dados → Formato HEX 01

ETB: Fim do bloco de dados por transmitir → Formato HEX 17

Tecla: 

Memória de dados
Padrão

Data memory (Memória de dados):

Standard (Padrão): Depois de iniciar uma tarefa de impressão, os dados serão recebidos até a memória temporária de impressão ficar cheia.

Extended (Expandido): Durante uma tarefa de impressão em curso continua a recepção e o processamento de dados.



Off (Desligado): Depois de iniciar uma tarefa de impressão não são recebidos mais dados.

Tecla: 

Teste de portas
Desligado

Port test (Teste do portal):

Verificação se os dados são transmitidos através da interface.

Premir a tecla  e  para seleccionar Geral (On). Premir a tecla e os dados que são enviados através de uma porta à escolha (COM1, LPT, USB, TCP/IP) são impressos.

Emulation (Simulação)

Sequência de teclas: **F**, , , , , , , , 

Menu de funções
Simulação



Tecla:

Protocolo
ZPL

Protocol (Protocolo):

CVPL: Carl Valentin Programming Language

ZPL: Zebra® Programming Language

Seleccionar o protocolo com as teclas  e . Premir a tecla para confirmar a selecção. A impressora é reiniciada e os comandos ZPL II® são convertidos internamente em comandos CVPL.

Tecla: 

Res. cabeça imp.
11.8 (Dot/mm)

Printhead resolution (Resolução da cabeça de impressão):

Caso esteja activada a simulação com ZPL II® deverá configurar-se a resolução da cabeça de impressão da impressora para a qual se está a fazer a simulação.

Tecla: 

Atribuição drive
B:->A: R:->R:

Drive mapping (Atribuição da drive):

O acesso a drives Zebra® é convertido para drives Valentin correspondentes.

Date & Time (Data & Hora)





Sequência de teclas: **F**, , , , , , , , , , 

Menu de funções
Data / Hora

Tecla: 

Data 17.11.04
Hora 13:28:06

Set date/time (Alteração da data e da hora):

A linha superior do visor indica a data actual, a linha inferior a hora actual. Com os botões  e  pode aceder o campo seguinte e aumentar ou diminuir os valores apresentados utilizando os botões  e .

Tecla: 

Hora de Verão
Ligado

Summertime (Hora de Verão):

Ligado: A impressora comuta automaticamente para a hora de Verão ou hora de Inverno.
Desligado: A hora de Verão não é automaticamente detectada e alterada.

Tecla: 

HV form. início
WW/WD/MM

Start of summertime - format (Formato início da hora de Verão):

Seleção do formato para introduzir o início da hora de Verão.

DD = Dia
WW = Semana
WD = Dia da semana
MM = Mês
YY = Ano,
next day = apenas o próximo dia é considerado

Tecla: 

WW WD MM
last Sunday 03

Start of summertime - date (Data início da hora de Verão):

A introdução da data de quando a hora de verão deve começar. Esta introdução refere-se ao formato anteriormente seleccionado. No exemplo acima, a hora de Verão é automaticamente alterada no último Domingo de Março (03).

Tecla: 

HV hora início
02:00

Start of summertime - time (Hora do início da hora de Verão):

Através desta função pode introduzir a hora de início da hora de Verão.

Tecla: 

HV formato final
WW/WD/MM

End of summertime - format (Formato final da hora de Verão):

Seleção do formato para introduzir o final da hora de Verão.

Tecla: 

WW WD MM
last Sunday 10

End of summertime - date (Data final da hora de Verão):

Introdução da data de fim da hora de Verão. A introdução refere-se ao formato anteriormente seleccionado. No exemplo acima, a hora de Verão é automaticamente alterada no último Domingo de Outubro (10).

Tecla: 

HV hora final
03:00

End of summertime - time (Hora final da hora de Verão):

Introdução da hora do fim da hora de Verão.

Tecla: 

Mudança de horas
01:00

Time shifting (Mudança da hora):

Introdução da mudança de hora, expressa em horas e minutos, para a hora de Verão/Inverno.

Service Functions (Funções de serviço)



AVISO!

De modo a que o distribuidor ou o fabricante possa prestar um serviço de apoio rápido, as informações necessárias como por ex. os parâmetros configurados podem ser lidas directamente no aparelho.

Sequência de teclas: **F**, , , , , , , , , , , 

Menú de funções
Funções serviço

Tecla: 

H P R1 R2 C ENC
0 1 1 0 0 0

Photocell parameters (Parâmetros relativos à barreira fotoelétrica):

H = Interruptor de tampa (apenas em aparelhos com interruptor da tampa)

0 = tampa aberta

1 = tampa fechou-se

P = Pressão:

Indicação de valor para controlo comprimido ar (0 ou 1).

R1 = Fita de transferência do rolo de enrolar:

Indicação do estado da fita de transferência do rolo de enrolar. São apresentados 4 estados (sem marcação na barreira fotoelétrica, a marcação é feita pela direita, a marcação é feita pela esquerda, marcação completa na barreira fotoelétrica).

R2 = Fita de transferência do rolo de desenrolar:

Indicação do estado da fita de transferência do rolo de desenrolar. São apresentados 4 estados (sem marcação na barreira fotoelétrica, a marcação é feita pela direita, a marcação é feita pela esquerda, marcação completa na barreira fotoelétrica).

C = Carreto: Indicação da posição do carreto de impressão.

ENC = Codificador: Indicação do estado do actual codificador.

Tecla: 

Capacidade (m)
D000007 G000017

Paper counter (Capacidade):

D: Indicação da capacidade de rendimento da cabeça de impressão, expressa em metros.

G: Introdução da capacidade de rendimento do aparelho, expressa em metros.

Tecla: 

Dot-Resistência
1250

Heater resistance (Dot-Resistência):

De modo a atingir uma boa imagem de impressão, em caso de troca da cabeça de impressão, deverão ser ajustados os valores de Ohm indicados na cabeça de impressão.

Tecla: 

Temper. cabeça
23

Printhead temperature (Temperatura das cabeças de impressão):

Indicação da temperatura das cabeças de impressão.

Tecla: 

Ribbon Ink Side
600 m Out

Ribbon / Ink side (Comprimento da fita de transferência / Enrolamento):

Ribbon (Comprimento da fita de transferência): Selecção do comprimento da fita de transferência utilizada

(300 m, 450 m, 600 m, 900 m, 1000 m).

Ink side (Lado da tinta):

Seleccionar se é utilizada fita de transferência enrolada para fora ou para dentro.

Defeito: Enrolamento para fora

Tecla: 

BrkPow BrkPowP
100 % 100 %

Brake power (Capacidade de travagem):

BrkPow: Ajuste da capacidade de travagem para acelerar e travar em %.

BrkPowP: Ajuste da capacidade de travagem durante a impressão.

Tecla: 

Exemp. impressão
Relat. do estado

Print examples (Exemplos de impressão):

Ao activar este ponto do menu obterá uma impressão com diversos ajustes do sistema de impressão directa.

Settings (Relatório de estado): São apresentadas todas as definições da impressora, por ex. velocidade, o material das etiquetas, o material das fitas de transferência etc.

Bar codes (Códigos de barras): São impressos todos os códigos de barras disponíveis.

Fonts (Fontes): São mostradas todas as fontes em formato bitmap e vectorial.

Tecla: 

Input: 11111111
Output: 00000000

Input/Output (Entradas/Saídas):

Indicações do nível do sinal que indicam com que sinal a impressão é iniciada.

0 = Low (baixo)

1 = High (alto)

Tecla: 

Diagnostic
Enter

Diagnostic (Diagnóstico):

Premir a tecla  para se entrar no modo de diagnóstico.

Tecla: 

EncProf	NoOfProf
Off	10

Encoder profiling (Perfilar o codificador):

Com o início da impressão são registados no cartão CF, nos ficheiros de registo, os valores do codificador. Com estes dados pode criar-se um gráfico da cura do codificador.

Tecla: 

DiaRU	DiaRW
68mm	655mm

Roller diameter**(Diâmetro do rolo da fita de transferência):**

DiaRW = Diâmetro da fita de transferência do rolo de enrolar.

DiaRU = Diâmetro da fita de transferência do rolo de desenrolar.

Tecla: 

Enc. Average
100

Encoder average (Média do codificador):

Quantidade dos valores através dos quais se transmitem os sinais do codificador.

Tecla: 

IgnrStrt	IntPrts
123	456

Diagnostic - Counter (Contador de diagnóstico):

IgnrStrt = Contador para os sinais de arranque ignorados.

IntPrts = Contador para as tarefas de impressão interrompidas.

Com o cursor, seleccione o valor sobre o qual pretende obter mais informações e carregue na tecla .

Tecla: 

Njb	Nrd	Prt
+000	+999	+999

NJb = No job (Sem tarefa):

Contador para os sinais de arranque ignorados por a tarefa de impressão não estar activa.

NRd = Not ready (Não está pronto):

Contador para os sinais de arranque ignorados por a tarefa de impressão não estar pronta (parada ou com mensagem de erro).

Prt = Printing (Em impressão):

Contador para os sinais de arranque ignorados por o aparelho se encontrar em impressão/activo.

Tecla: 

MS/I	ItfI	SpdS
+000	+999	+999

MS/I = Manual stopped/interrupted (Paragem/interrupção manual):

Foi premida a tecla de paragem no teclado de membrana, no painel ou num programa.

ItfI = Interface interrupted (Interface interrompida):

Foi interrompida a tarefa de impressão porque foram recebidas novas informações por meio de uma interface.

SpdS = speed stopped (Velocidade parada):

A tarefa de impressão foi interrompida porque a velocidade de impressão medida era demasiado lenta.

Tecla: 

Online/Offline
Desligado

Online/Offline (Online/Offline):

Se esta função estiver activada poderá seleccionar-se entre o modo on-line e o modo offline com o botão  (Padrão = Desligada).

Online (Online): É possível receber dados através das interfaces. Os botões do teclado apenas se encontram activas caso se tenha mudado para o modo offline com o botão .

Offline (Offline): Os botões do teclado encontram-se de novo activos, mas as informações recebidas já não são processadas. Quando o aparelho voltar a estar no modo online voltarão a ser recebidas novas tarefas de impressão.

Tecla: 

Pré-aviso tr.
On ø: 40 v: 100

Transfer ribbon prior warning (Pré-aviso de fita de transferência):

é emitido um sinal por uma saída de comando antes do fim da fita de transferência.

Warning diameter (Diâmetro de pré-aviso):

Ajuste do diâmetro de pré-aviso da fita de transferência.

Se neste ponto for apresentado um valor em mm, quando se alcançar esse diâmetro (medido na fita de transferência) é dado um sinal por meio de uma saída de controlo.

v = reduced speed (Velocidade de impressão reduzida):

Ajuste da velocidade de impressão reduzida. Esta pode ser configurada dentro dos limites da velocidade normal de impressão.

-: Sem velocidade de impressão reduzida

0: Ao alcançar o diâmetro de pré-aviso, a impressora pára com "erro da fita de transferência".

Main Menu (Menu inicial)

Depois de ligar o módulo aparece no visor a seguinte informação:



* DC c107-12K * 14/09/05 10:16	Primeira linha = menu inicial segunda linha = data e hora actual
Tecla: <input type="radio"/>	
* DC c107-12K * V1.44	Segunda linha = número da versão do firmware
Tecla: <input type="radio"/>	
* DC c107-12K * Build 0201	Segunda linha = versão da compilação do software
Tecla: <input type="radio"/>	
* DC c107-12K * Jun 2 2005	Segunda linha = data de criação do firmware
Tecla: <input type="radio"/>	
* DC c107-12K * 10:37:34	Segunda linha = hora de criação da versão do firmware
Tecla: <input type="radio"/>	
* DC c107-12K * E-Font: V5.01	Segunda linha = versão do tipo de letra no formato bitmap
Tecla: <input type="radio"/>	
* DC c107-12K * V-Font: V1.01	Segunda linha = versão do tipo de letra no formato vectorial
Tecla: <input type="radio"/>	
* DC c107-12K * FPGA V1.4.0 T9	Segunda linha = número de versão dos dois FPGAs (P = cabeça de impressão; I = E/S)
Tecla: <input type="radio"/>	
* DC c107-12K * 16 MB Memory	Segunda linha = Capacidade de armazenamento do aparelho em MB
Tecla: <input type="radio"/>	
* DC c107-12K * 8 MB FLASH	Segunda linha = Tamanho do armazenamento da FLASH em MB
Tecla: <input type="radio"/>	
* DC c107-12K * A0 MO V.1.3.1 AB	Segunda linha = Número de versão do primeiro processador (accionamento do motor)
Tecla: <input type="radio"/>	
* DC c107-12K * A1 MO V.1.3.1 AB	Segunda linha = Número de versão do segundo processador (accionamento do motor)
Tecla: <input type="radio"/>	
* DC c107-12K * A2 IO V.1.3.1 AB	Segunda linha = Número de versão do terceiro processador (monitorização de I/O)

CF Card (Cartão Flash compacto)

Select layout (Escolher o layout)

Sequência de teclas: 



```
→layout 01 0
A:\STANDARD
```

Premir as teclas  e  para seleccionar o layout desejado no directório STANDARD.
Premir a tecla  para escolher o layout.

```
Iníc. impressão
Número: 12345
```

Escolher o número de layouts a serem imprimidos.
Premir a tecla  para iniciar a tarefa de impressão.

Load file (Carregar o ficheiro)



Sequência de teclas: , 

```
Funções CF
Carregar fich.
```



Tecla: 

```
□→ . . <
A:\STANDARD
```

Selecione o ficheiro desejado e confirme a sua selecção com .

Prima a tecla  e introduza o número de exemplares que pretende.. Confirme a selecção com  e o pedido de impressão é iniciado através de um sinal externo (Entrada 1, PIN1 e PIN4).

Save layout (Memorizar a layout)

Sequência de teclas: , , 

```
Funções CF
Memorizar layout
```

Tecla: 

```
Ficheiro existe
resto?
```

Selecione o directório/layout que pretende guardar e confirme a selecção com .

Confirme a consulta anterior com  e a layout é guardada.

Save configuration (Guardar a configuração)

Sequência de teclas: , , , 

```
Funções CF
Guardar config.
```

Por defeito é sempre sugerido o nome config.cfg para o ficheiro. Este poderá ser alterado pelo utilizador. Neste ficheiro são guardados os parâmetros do módulo de impressão que não são permanentemente arquivados na Flash interna.

Premir a tecla  para activar a tarefa de impressão.

Change directory (Mudar o directório)



Sequência de teclas: , , , , 

```
Funções CF
Mudar directório
```

Tecla: 

```
←<.> M
A:\STANDARD\
```

Na linha inferior é apresentado o directório que se encontra presentemente seleccionado.

Premir as teclas  e  para mudar o directório para a linha superior.

Premir as teclas  e  para apresentar os directórios possíveis.

Premir a tecla  para adoptar o directório seleccionado.

Delete file (Apagar um ficheiro)

Sequência de teclas: , , , , , 

Funções CF
Apagar ficheiro

Selecione o directório/layout que pretende apagar e confirme a selecção com .



Format CF card (Formatar o cartão Flash compacto)

Sequência de teclas: , , , , , , 

Funções CF
Formatar

Tecla: 

Formatar A:

Selecione com a tecla  a unidade a formatar do cartão Flash compacto e confirme a selecção com . Ao formatar, é automaticamente criado o directório STANDARD.

Free memory space (Indicar a capacidade de memória livre no cartão Flash compacto)

Sequência de teclas: , , , , , , , 

Funções CF
Memória livre

É indicada a capacidade de memória ainda livre no cartão Flash compacto.

Especificações técnicas

	Dynacode 53	Dynacode 107	Dynacode 128
Resolução	300 dpi	300 dpi	300 dpi
Velocidade de impressão			
Modo contínuo	50 ... 800 mm/s	50 ... 600 mm/s	50 ... 450 mm/s
Modo intermitente	50 ... 600 mm/s	50 ... 600 mm/s	50 ... 600 mm/s
Velocidade de retorno	apenas modo intermitente: max. 600 mm/s		
Largura de impressão	53,3 mm	106,6 mm	128 mm
Máx. comprimentos de impressão			
Modo contínuo	6000 mm	3000 mm	3000 mm
Modo intermitente	75 mm	75 mm	75 mm
Largura de passagem da moldura	de acordo com as necessidades dos clientes		
Cabeça de impressão	Corner Type	Corner Type	Corner Type
Emissão sonora (distância de medição 1 m)			
Nível médio de potência sonora	60 dB(A)	65 dB(A)	68 dB(A)
Fita de transferência			
Lado da tinta	externo / interno (opcional)	externo / interno (opcional)	externo / interno (opcional)
Máx. diâmetro dos rolos	98 mm	82 mm	75 mm
Diâmetro do núcleo	25,4 mm / 1"	25,4 mm / 1"	25,4 mm / 1"
Máx. comprimento	900 m	600 m	450 m
Máx. largura	55 mm	110 mm	130 mm
Dimensões (largura x altura x profundidade)			
Sistema mecânico de impressão			
sem estrutura de montagem	204 x 180 x 234 mm	204 x 180 x 290 mm	204 x 180 x 312 mm
com estrutura de montagem	dependendo da largura de passagem		
Sistema electrónico de comando	240 x 125 x 332 mm conjunto de cabos de ligação a mecânica 2,5 m		
Gewicht			
Mecânica de impressão	9,5 kg	11 kg	11,7 kg
Electrónica incl. cabo	5,5 kg	5,5 kg	5,5 kg
Sistema electrónico			
Processador	High Speed 32 Bit		
Memória de trabalho (RAM)	16 MB / 64 MB (sob encomenda)		
Entrada	Para cartão Compact Flash modelo I		
Bateria	Para relógio de tempo real (gravação de dados em caso de falha de energia)		
Sinal de aviso	Sinal sonoro em caso de avaria		
Interfaces			
Série	RS-232C (até 115200 Baud)		
Paralelo	Centronics		
Ethernet	10/100 Base T		
USB	1.1		
Especificações			
Ligação pneumática	min. 6 bar seco e isento de óleo		
Tensão de alimentação	110 ... 230 V / 50 ... 60 Hz		
Corrente	230 V / 1,5 A – 110 V / 3 A		
Válvulas de protecção	230 V / 2 AT – 110 V / 4 AT		
Requisitos operacionais			
Temperatura	5 ... 40 °C		
Humidade relativa	máx. 80% (sem condensação)		

Panel de comando	
Teclas	Impressão de teste, menu, quantidade, cartão de memória, Feed, Enter, 4 x Cursor
Visor LCD	Visor gráfico 132 x 32 pixéis iluminação de fundo verde
Definições	
	Data, hora, intervalos 11 opções de língua (mais sob encomenda) Parâmetros de etiquetas e dos aparelhos, interfaces, protecção com palavra-chave
Verificações	
Paragem da impressão em caso de	Fim da fita de transferência / fim do esquema / cabeça de impressão aberta
Vista de estado	Vista das definições do aparelho, por ex. rendimento, parâmetros das células fotoeléctricas, das interfaces e da rede Vista dos tipos de letra assim como de todos os códigos de barras suportados
Texto	
Tipos de letra	6 Fontes Bitmap 8 Fontes vectoriais/TrueType 6 Fontes proporcionais Mais tipos de letra sob encomenda
Conjunto de caracteres	Windows 1250 até 1257, DOS 437, 850, 852, 857 São suportados todos os caracteres da Europa ocidental e oriental, latinos, cirílicos, gregos e árabes (opcional) Mais conjuntos de caracteres sob encomenda
Fontes bitmap	Tamanho em largura e altura 0,8 ... 5,6 Factor de ampliação 2 ... 9 Orientação 0°, 90°, 180°, 270°
Fontes vectoriais/Fontes TrueType	Tamanho em largura e altura 1 ... 99 mm Factor de ampliação progressivo Orientação 0°, 90°, 180°, 270°
Propriedades do texto	Dependendo do tipo de letra negrito, itálico, invertido, vertical
Espaçamento entre caracteres	Variável
Código de barras	
Código de barras 1D	CODABAR, Code 128, Code 2/5 interleaved, Code 39, Code 39 extended, Code 93, EAN 13, EAN 8, EAN ADD ON, GS1-128, Identcode, ITF 14, Leitcode, Pharmacode, PZN 7 Code, PZN 8 Code, UPC-A, UPC-E
Código de barras 2D	Aztec Code, CODABLOCK F, DataMatrix, GS1 DataMatrix, MAXICODE, PDF 417, QR Code
Código de barras mistos	GS1 DataBar Expanded, GS1 DataBar Limited, GS1 DataBar Omnidirectional, GS1 DataBar Stacked, GS1 DataBar Stacked Omnidirectional, GS1 DataBar Truncated
	Todos os códigos de barras são variáveis em altura, largura do módulo e proporção Orientação 0°, 90°, 180°, 270° Dígito de verificação e conversão de texto opcionais
Software	
Configuração	ConfigTool
Controlo do processo	NiceLabel
Software das etiquetas	Labelstar Office Lite Labelstar Office
Drivers Windows	Windows XP® 32/64 Bit, Windows Vista® 32/64 Bit Windows 7® 32/64 Bit, Windows 8® 32/64 Bit Windows 8.1® 32/64 Bit, Windows Server 2003® (R2) 32/64 Bit Windows Server 2008® 32/64 Bit, Windows Server 2008® (R2) 64 Bit Windows Server 2012® 64 Bit, Windows Server 2012® (R2) 64 Bit

Reserva-se o direito de alterações técnicas

Limpeza e manutenção



PERIGO!

Perigo de vida por choque eléctrico!

⇒ Antes de proceder a trabalhos de manutenção, retirar a ficha do módulo da corrente.

Limpar a cabeça de impressão



AVISO!

Recomenda-se o uso de dispositivos de protecção pessoais como óculos de protecção e luvas para a limpeza do aparelho.

A impressão deposita sujidade na cabeça de impressão, p.ex. através das partículas de tinta da fita de transferência. Por isso é indicado e necessário limpar a cabeça de impressão em determinados intervalos de tempo, dependendo das horas de funcionamento e das condições ambientais, tais como poeiras etc..



CUIDADO!

Perigo de danificar a impressora de etiquetas!

⇒ Não utilize objectos afiados ou duros para a limpeza da cabeça de impressão.

⇒ Não toque na camada de protecção de vidro da cabeça de impressão.

- Remover a fita de transferência.
- Limpe a superfície da cabeça de impressão com um cotonete embebido em álcool puro.
- Antes da colocação em funcionamento do módulo, deixar a cabeça de impressão secar durante 2–3 minutos.



AVISO!

Devem ser respeitadas as normas de manuseamento para utilização de Isopropanol (IPA). Em caso de contacto com a pele ou os olhos lavar bem sob água corrente. Em caso de irritações permanentes consultar o médico. Garantir uma boa ventilação.

Substituir a cabeça de impressão



CUIDADO!

Danificação da cabeça de impressão por meio de descargas electrostáticas ou influências mecânicas!

⇒ Colocar o aparelho sobre uma base condutora de terra.

⇒ Ligar a estrutura à terra, utilizando por exemplo uma pulseira ligado à terra.

⇒ Não tocar nos contactos existentes nas ligações.

⇒ Não tocar na barra de pressão com objectos duros ou com as mãos.

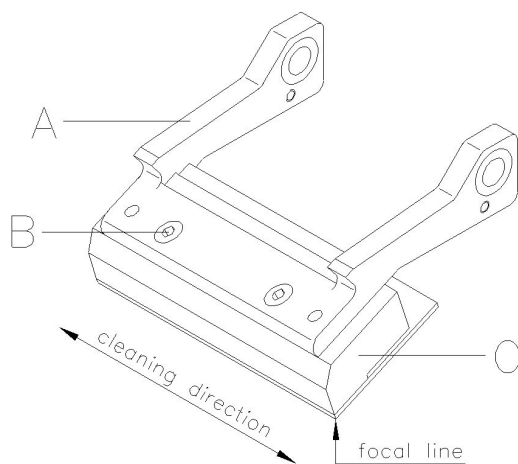

Desmontar a cabeça de impressão

- Retirar a película de transferência.
- Empurrar a unidade da cabeça de impressão para a posição de assistência adequada.
- Premir o suporte da cabeça de impressão (A) ligeiramente para baixo até que se possa introduzir uma chave sextavada (SW 2,5) nos parafusos (B).
- Remover os parafusos (B) e retirar a cabeça de impressão (C).
- Puxar a ficha de ligação que se encontra na parte de trás da cabeça de impressão.

Montar a cabeça de impressão

- Ligar as fichas à nova cabeça de impressão.
- Posicionar a cabeça de impressão no suporte da cabeça de impressão (A) de forma que os alimentadores se fixem nas respectivas furacões no suporte da cabeça de impressão (A).
- Premir o suporte da cabeça de impressão (A) ligeiramente com um dedo sobre o rolo de impressão e verificar o posicionamento correcto da cabeça de impressão (C).
- Introduzir e apertar o parafuso (B) com a chave sextavada.
- Voltar a colocar o material da fita de transferência.
- Nas 'Funções Assistência/Dot Resistência' deverá introduzir-se o valor de resistência da nova cabeça de impressão. O valor poderá ser consultado na placa de identificação da cabeça de impressão.
- Testar a posição da cabeça de impressão fazendo uma impressão de teste.

Ajuste do ângulo (modo intermitente)

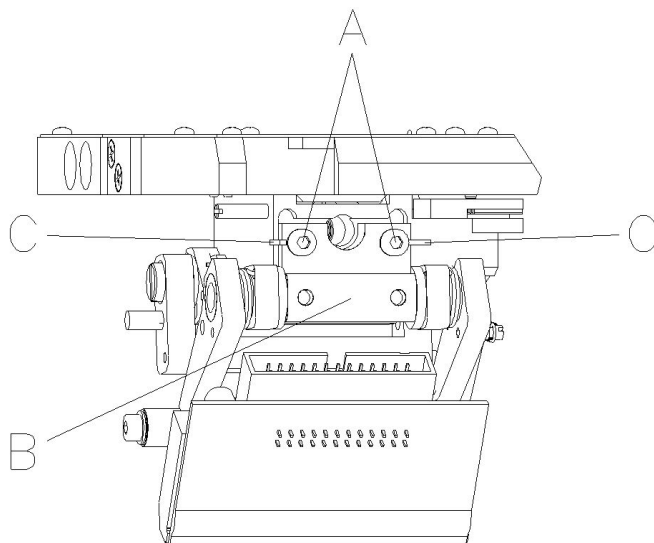

Por defeito, o ângulo de montagem da cabeça de impressão é de 26° relativamente à superfície de impressão. No entanto, as tolerâncias de produção da cabeça de impressão e da mecânica poderão exigir outro ângulo.



CUIDADO!

Danificação Da cabeça de impressão devido a um desgaste desigual!
Maior desgaste da fita de transferência devido a uma ruptura mais rápida.
⇒ Alterar as definições de fábrica apenas em casos excepcionais.

- Soltar ligeiramente o parafuso sextavado interior (A).
- Deslocar a peça de ajuste (B) de forma a deslocar o ângulo entre a cabeça de impressão e o suporte da cabeça de impressão.
Deslocar para baixo = diminuir o ângulo
Deslocar para cima = aumentar o ângulo
- Voltar a apertar o parafuso sextavado interior (A).
- Iniciar uma tarefa de impressão de cerca de 3 desenhos e controlar se a fita corre de forma correcta e sem dobras.



AVISO!

As ranhuras introduzidas (C) servem para um controlo de posição. Deverá tentar obter-se uma definição o mais paralela possível.

Kısa kullanım kılavuzu ve ürün
güvenliğiyle ilgili uyarılar

Türkçe

copyright by Carl Valentin GmbH

Teslimat, görünüm, kapasite, ölçüler ve ağırlık ile ilgili veriler, baskı anındaki mevcut bilgilerimize uygundur. Değişiklik hakkı saklıdır.

Çeviri dahil, tüm hakları saklıdır.

Eserin, hiçbir bölümü, hiçbir şekilde (basım, fotokopi veya başka bir yöntemle) Carl Valentin GmbH şirketinin yazılı izni olmadan yeniden üretilemez veya elektronik sistemler yardımıyla işlenemez, çoğaltılamaz veya dağıtılamaz.

Cihazlar sürekli geliştirildiğinden doküman ve cihaz arasında farklılıklar olabilir. Güncel baskı için www.carl-valentin.de adresine bakınız.

Ticari marka

Belirtilen tüm markalar veya ticari markalar, ilgili sahiplerine ait tescilli markalar veya tescilli ticari markalar olup ayrıca işaretlenmiş olmayabilir. İşaretlemenin olmamasından, tescilli bir markanın veya tescilli bir ticari markanın söz konusu olmadığı sonucuna varılamaz.

Carl Valentin doğrudan baskı mekanizmaları aşağıdaki güvenlik yönergelerine uygunluk göstermektedir:

- CE** AB-Makina Standartları (98/37/EG)
AB Alçak Voltaj Yönergesi (2006/95/EG)
AB Yönergesi Elektromanyetik Kirlilik (89/336/EWG)



Carl Valentin GmbH

Postfach 3744
78026 Villingen-Schwenningen
Neckarstraße 78 – 86 u. 94
78056 Villingen-Schwenningen

Phone +49 (0)7720 9712-0
Fax +49 (0)7720 9712-9901

E-Mail info@carl-valentin.de
Internet www.carl-valentin.de

İçindekiler

Tekniğine uygun kullanım	176
Güvenlik uyarıları	176
Çevre dostu tasfiye	177
İşletim koşulları	178
Doğrudan baskı mekanizmasının ambalajından çıkarılması	181
Teslimat kapsamı	181
Doğrudan baskı mekanizmasının bağlantısının yapılması	181
Çalıştırma hazırlıkları	181
Baskı çalıştırma	181
Doğrudan baskı mekanizmasının devreye alma	181
Aktarma şeridi kasetini takın	182
Print Settings (Yazdırmayı başlatma)	183
Machine Parameters (Makine parametreleri)	183
Layout Parameters (Düzen)	184
Ribbon Save (Optimizasyon) - Sürekli mod	185
Ribbon Save (Optimizasyon) - Aralıklı mod	187
Device Settings (Cihaz parametreleri)	188
I/O Parameters (G/Ç parametreleri)	189
Network (Ağ)	189
Remote Console (Uzaktaki konsol)	189
Interface (Arabirimler)	190
Emulation (Emülasyon)	190
Date & Time (Tarih ve saat)	191
Service Functions (Servis işlevleri)	192
Main Menu (Ana menü)	194
Compact Flash Kartı	195
Teknik veriler	197
Yazdırma kafasının temizlenmesi	199
Baskı başını değiştirin	199
Açı ayarı (aralıklı mod)	200

Tekniğine uygun kullanım

- Doğrudan baskı mekanizması en ileri teknoloji ve onaylanan güvenlik tekniği prensiplerine göre üretilmiştir. Buna rağmen kullanım sırasında kullanıcıya veya üçüncü kişilere yönelik bedensel ve hayati tehlikeler ya da doğrudan baskı mekanizması veya başka maddi değerler üzerinde olumsuz etkiler meydana gelebilir.
- Doğrudan baskı mekanizması yalnızca teknik yönden sorunsuz bir durumda olduğu takdirde, ayrıca usulüne göre, güvenlik ve tehlike bilinciyle bu kullanım kılavuzunun dikkate alınması koşuluyla kullanılabilir! Özellikle güvenliği olumsuz yönde etkileyen arızalar derhal giderilmelidir.
- Doğrudan baskı mekanizması yalnızca uygun ve üretici tarafından izin verilen malzemelerin yazdırılması için tasarlanmıştır. Başka ya da bunun dışındaki kullanımlar usulüne uygun değildir. Amaç dışı kullanımdan kaynaklanabilecek hasarlardan üretici/teslimatçı sorumlu değildir; bu riski tek başına kullanıcı taşır.
- Usulüne uygun kullanım kapsamına ayrıca kullanım kılavuzunun dikkate alınması ve üretici tarafından verilen bakım tavsiyeleri/talimatları da dahildir.

Güvenlik uyarıları

- Doğrudan baskı mekanizması 110 V ile 230 V arasındaki alternatif gerilimli akım şebekeleri için tasarlanmıştır. Doğrudan baskı mekanizmasını yalnızca topraklı prizlere bağlayın.



DUYURU!

Şebeke voltajı değiştirildiğinde sigorta değeri adaptasyonu gerektiği şekilde yapılacaktır (bakınız 'Teknik veriler').

- Doğrudan baskı mekanizmasını yalnızca topraklı alçak gerilim ileten cihazlara bağlayın.
- Bağlantıları oluşturmadan veya çıkarmadan tüm bağlı cihazları (bilgisayar, modül, aksesuar) kapatın.
- Doğrudan baskı mekanizmasını yalnızca kuru bir ortamda çalıştırın ve ıslaklığa (püskürtme suyu, sis, vs.) maruz bırakmayın.
- Doğrudan baskı mekanizmasını, patlama tehlikesi bulunan atmosferde ve yüksek gerilim hatlarının yakınında kullanmayın.
- Cihazı sadece taşlama tozları, metal kıymıkları ve benzer yabancı cisimlerden korunmuş ortamlarda kullanın.
- Doğrudan baskı mekanizması kapağı açık olarak çalıştırılacaksa, elbise, saç, takı veya kişilerin üzerinde taşıdıkları benzeri eşyaların açıkta duran, döner parçalarla temas etmemesine dikkat edin.



DUYURU!

Açık haldeki baskı ünitesinde, yapısal özelliğinden dolayı yangından korunma gövdesine ilişkin EN60950-1 talepleri yerine getirilmemiştir. Bunlar nihai cihazın içine takılarak garanti altına alınmalıdır.

- Baskı modülü, baskı sırasında ısınabilir. Çalışma sırasında dokunmayın ve malzeme değişikliğinden, sökmeden veya ayarlamadan önce soğumasını bekleyin.
- Yalnızca bu kullanım kılavuzunda belirtilen işlemleri uygulayın. Bunun ötesindeki çalışmalar sadece üretici tarafından ya da üretici ile koordineli olarak yapılabilir.
- Elektronik yapı gruplarındaki ve bunların yazılımlarındaki amacına uygun olmayan müdahaleler, arızalara neden olabilir.
- Cihaz üzerindeki amacına uygun olmayan işlemler veya değişiklikler, çalışma güvenliğini tehlikeye sokabilir.
- Servis çalışmalarının her zaman gerekli çalışmayı gerçekleştirmek için gerekli uzman bilgisine ve takımlarına sahip olan yetkili bir atölyede yapılmasını sağlayın.
- Cihazlarda tehlikelere dikkat çeken çeşitli ikaz uyarıları takılmıştır. Bu yapıştırmaları sökmeyin, aksi takdirde tehlikeler algılanmaz.
- Doğrudan baskı mekanizması, bütün makineye montaj sırasında acil kapama devresine bağlanmalıdır.
- Makineyi çalıştırmaya başlamadan önce bütün ayırıcı koruyucu donanımların takılmış olması gerekir.



TEHLİKE!

Şebeke gerilimi nedeniyle ölüm tehlikesi!

⇒ Cihazın mahfazasını açmayın.

Çevre dostu tasfiye

B2B cihazlarının üreticilerinin 23.03.2006 tarihinden itibaren, 13.08.2005 tarihinden sonra üretilen cihazları geri alması ve imha etmesi gerekir. Bu eski cihazların halka açık toplama yerlerine verilmesi prensip olarak yasaktır. Bunlar sadece üretici tarafından organize edilmiş olarak yeniden değerlendirilebilir ve imha edilebilir. Bu nedenle uygun işletmelere sahip olan Valentin ürünleri bundan sonra Carl Valentin GmbH şirketine geri verilebilir.

Buna göre eski cihazlar, gerektiği gibi imha edilecektir.

Carl Valentin GmbH şirketi bu sayede eski cihazların imhası çerçevesinde her türlü sorumluluğu gerektiği şekilde gerçekleştirir ve bu sayede ürünlerin sorunsuz bir şekilde dağıtımını sağlamaya da devam eder. Sadece gönderi ücreti karşılanmış olan cihazların iadesini kabul edebiliriz.

Ayrıntılı bilgileri WEEE yönetmeliğinden veya www.carl-valentin.de adresindeki internet sayfamızdan edinebilirsiniz.

İşletim koşulları

İşletme koşulları, güvenli ve arızasız bir çalışma sağlamak için cihazlarımızı devreye sokmadan önce ve işletme sırasında gerçekleştirilmiş olması gereken koşullardır.

Lütfen işletme koşullarını dikkatli bir biçimde okuyun.

İşletme koşullarının pratik olarak uygulanmasıyla ilgili olarak sorularınız olduğu takdirde, bizimle veya sizin için yetkili müşteri hizmetleriyle irtibata geçin.

Genel bilgiler

Cihazlar, kurulumu kadar sadece orijinal ambalajlarında taşınmalı ve saklanmalıdır.

Cihazlar, işletme koşulları yerine getirilmeden önce kurulmamalı ve devreye sokulmamalıdır.

Bu eksik makinenin takılacağı makinenin, 2006/42/EG sayılı makine yönetmeliğinin koşullarına uygun olduğu (geçerli olduğu ölçüde) tespit edilene kadar, devreye sokulması yasaktır.

Cihazlarımızı devreye sokma, programlama, kullanma, temizleme ve bakımdan geçirme sadece talimatlarımız iyice okunduktan sonra gerçekleştirilmelidir.

Cihazlar sadece gerekli eğitimleri almış personel tarafından kullanılmalıdır.



DUYURU!

Eğitimlerin tekrarlanmasını tavsiye ederiz.

Eğitim içeriklerinin konu başlıkları 'İşletme koşulları', 'Aktarma bandını takma' ve 'Temizlik ve bakım'.

Uyarılar, bizim sağladığımız yabancı cihazlar için de geçerlidir.

Sadece orijinal yedek parçalar ve değiştirme parçaları kullanılmalıdır.

Yedek ve yıpranan parçalar için lütfen üreticisine başvurun.

Lityum pille ilgili bilgiler

Modülün işlemcisinde bulunan lityum (Tip CR 2032) pil için pil yönetmeliği geçerli olup, boş pillerin piyasadaki ve resmi atık imha taşıyıcılarındaki boş pil atık kutularına atılmasını gerektirir. Piller tam boşalmadıysa, kısa devreler için önlemlerin alınması gerekir. Modül devre dışı bırakıldığında pilin muhakkak modülden ayrı olarak imha edilmesi gerekir.



TEHLİKE!

Patlama nedeniyle ölüm tehlikesi!

⇒ İletken olmayan alet kullanın.

Kurulum yeri için geçerli koşullar

Kurulum alanının düz, sarsıntısız, salınım ve hava akımı olmayan bir yer olması gerekir.

Cihazlar, ideal bir kullanımı ve bakım için kolay bir erişimi garanti edecek şekilde yerleştirilmelidir.

Standart adaptörü takma

Cihazlarımızı bağlamak için adaptörün, uluslararası yönetmeliklere ve bunlara dayanan kurallara göre takılması gerekir. Bunların arasında özellikle aşağıdaki üç komisyonun tavsiyeleri de vardır:

- Uluslararası Elektronik Komisyon (IEC)
- Avrupa Elektronik Standartları Komitesi (CENELEC)
- Alman Elektrik Teknisyenleri Birliği (VDE)

Cihazlarımız VDE güvenlik sınıfı I'e göre yapılmıştır ve bir koruyucu iletken bağlantısına bağlanmaları gerekir. Standart adaptörün, cihazın içindeki arızalı akımları gidermek için bir koruyucu iletken bağlantısının bulunması gerekir.

Adaptörle ilgili teknik veriler

Şebeke voltajı ve şebeke frekansı:	Model plakasına bakın
Şebeke voltajı için izin verilen tolerans:	Nominal değer +%6 ila -%10
Şebeke frekansı için izin verilen tolerans:	Nominal değer +%2 ila -%2
Şebeke voltajı için izin verilen distorsiyon faktörü:	<=5%

Arıza giderme yöntemleri:

Çok aşırı kirli şebekelerde (örneğin tristör kumandalı tesisler kullanıldığında) fabrikada arıza giderme önlemlerinin alınması gerekir. Örneğin aşağıdaki seçenekleriniz bulunur:

- Cihazlarımıza gelen ayrı şebeke hatları döşeyin.
- Sorun oluştuğunda kapasite olarak ayrılan ayırma trafosunu veya diğer arıza giderme cihazlarını cihazlarımızın önündeki şebeke hattına takın.

Parazit ışınları ve parazitlere karşı dayanıklılık

EN 61000-6-4: 08-2002 uyarınca parazit yayını/emisyon

- EN 55022: 09-2003 uyarınca hatlardaki arızalı gerilim
- EN 55022 uyarınca parazit alanı gücü 09-2003
- EN 61000-3-2 uyarınca üst titreşim akımları (şebeke tepkisi): 09-2005
- EN 61000-3-3 uyarınca titreşim: 05-2002

EN 61000-6-2: 03-2006 uyarınca parazite karşı dayanıklılık

- EN 61000-4-2: 12-2001 uyarınca statik elektrik boşalmasına karşı parazitlere karşı dayanıklılık
- EN 61000-4-3: 11-2003 uyarınca elektromanyetik alanlar
- EN 61000-4-4: 07-2005 uyarınca hızlı geçici parazitlere (patlama) karşı dayanıklılık
- EN 61000-4-5: 12-2001 uyarınca yüksek frekanslı alanlardan kaynaklanan, iletken hatlardaki parazitlere karşı dayanıklılık
- EN 61000-4-6: 12-2001 uyarınca HF voltajı
- EN 61000-4-11: 02-2005 uyarınca voltaj kesintileri ve voltaj düşüşleri



DUYURU!

Bu, A sınıfı bir tertibattır. Bu tertibat, ikamet alanında telsiz arızalarına neden olabilir; bu durumda işletenden uygun önlemleri alması ve bunları karşılaması istenebilir.

Makine emniyeti

- EN 415-2 – Ambalaj makinelerinin emniyeti
- EN 60204-1:2006 – Makinelerin emniyeti – elektrikli makine donanımları – bölüm 1

Harici cihazlarla bağlantı hatları

Tüm bağlantı hatlarının yalıtılmış hatlardan geçirilmesi gerekir. Yalıtım örgüsünün her iki tarafta da fiş mahfazasının alanına bağlanması gerekir.

Akım hatlarıyla paralel hat döşemesi bulunmamalıdır. Kaçınılmaz paralel döşeme durumlarında en az 0,5 m'lik bir asgari mesafeye uyulması gerekir.

Bağlantıların sıcaklık aralığı: -15 ila +80 °C.

Sadece 'Safety Extra Low Voltage' (SELV – Güvenlik Ek Düşük Voltajı) şartını sağlayan elektrik devrelerine sahip olan cihazlar bağlanmalıdır. Bunlar genellikle EN 60950 standardına göre kontrol edilmiş olan cihazlardır.

Veri hatlarının kurulumu

Veri kablolarının tam yalıtılmış ve metal ya da metali takma bağlantısı mahfazalarıyla donatılmış olması gerekir. Yalıtılmış kablo ve takma bağlantıları, elektrikli arızaların yayılmasını ve alınmasını önlemek için gerekir.

İzin verilen hatlar

Yalıtımlı hat: 4 x 2 x 0,14 mm² (4 x 2 x AWG 26)
6 x 2 x 0,14 mm² (6 x 2 x AWG 26)
12 x 2 x 0,14 mm² (12 x 2 x AWG 26)

Gönderme ve alma hatlarının çift olarak döşenmesi gerekir.

Maksimum hat uzunlukları: V 24 (RS232C) arabiriminde - maks. 19200 bds için 15 m
Centronics'te - 3 m
USB - 3 m
Ethernet - 100 m

Hava dolaşımı

İzin verilmeden bir ısınmayı önlemek için, cihazın çevresinde serbest bir hava dolaşımının oluşabilmesi gerekir.

Sınır değerleri

IP'ye göre koruma türü: 20
Ortam sıcaklığı °C (işletme): min. +5 maks. +40
Ortam sıcaklığı °C (taşıma, depolama): min. -25 maks. +60
Nispi nem oranı % (işletme): maks. 80
Nispi nem oranı % (taşıma,depolama): maks. 80 (cihazların buğulanmasına izin verilmez)

Garanti

Aşağıdakilerden kaynaklanabilecek hasarlardan dolayı hiçbir sorumluluk kabul etmeyiz:

- İşletme koşullarımıza ve kullanım kılavuzuna uyulmaması.
- Çevrenin hatalı elektrik tesisatı.
- Cihazlarımız üzerinde yapılan yapısal değişiklikler.
- Hatalı programlama ve kullanım.
- Yapılmayan veri yedeklemesi.
- Orijinal olmayan yedek parçaların ve aksesuarların kullanılması.
- Doğal aşınma ve yıpranma.

Cihazları yeni ayarladığınızda veya programladığınızda, yeni ayarı bir deneme çalıştırması ve deneme yazdırması yardımıyla kontrol edin. Bu sayede hatalı sonuçları, çizimleri ve değerlendirmeleri önlersiniz.

Cihazlar sadece gerekli eğitimleri almış çalışanlar tarafından kullanılmalıdır.

Ürünlerimizin düzgün kullanılıp kullanılmadığını kontrol edin ve eğitimleri tekrarlayın.

Bu kullanım kılavuzunda açıklanan özelliklerin tüm modellerde bulunduğunu garanti etmiyoruz. Sürekli geliştirme ve iyileştirme gayretimizden dolayı, haber verilmeksizin teknik verilerde değişiklikler olabilir.

Sürekli geliştirme veya ülkeye özel kurallardan dolayı kullanım kılavuzundaki resim ve örnekler, teslim edilen modelden farklı olabilir.

Hasarların önüne geçmek veya cihazın vaktinden önce aşınmasını önlemek için lütfen izin verilen modül ortamları hakkındaki bilgilere ve cihazın bakımıyla ilgili uyarılara dikkat edin.

Bu elkitabını anlaşılır bir biçimde hazırlamaya ve size olabildiğince çok bilgi sağlamaya çalıştık. Elkitablarımızı iyileştirebilmemiz için, herhangi bir sorunuz varsa veya herhangi bir hata bulduğunuzda lütfen bunları bize bildirin.

Doğrudan baskı mekanizmasının ambalajından çıkarılması

- ⇒ Doğrudan baskı mekanizmasını kartondan kaldırıp çıkartın.
- ⇒ Doğrudan baskı mekanizmasını nakliye hasarlarına karşı kontrol edin.
- ⇒ Teslimatın eksiksiz olduğunu kontrol edin.

Teslimat kapsamı

- Baskı mekanizması.
- Manometre.
- Karton çekirdeği (boş), aktarma bandı sargısına önceden monte edilmiş.
- Kumanda elektroniği.
- Pnömatik hortumu.
- Baskı başı için temizleme folyosu.
- Elektrik kablosu.
- Vida bağlantısı.
- Belgeler.
- Bağlantı kablosu (sensörler, güç).
- I/O aksesuarı (I/O'lar, I/O 24 kabloları için karşı fiş).
- Yazıcının sürücü CD'si.
- Mini regülatör.
- 1 rulo aktarma bandı.



DUYURU!

Orijinal ambalajı ileriki taşıma işleri için muhafaza edin.

Doğrudan baskı mekanizmasının bağlantısının yapılması

Modül geniş aralıklı bir şebeke adaptörüyle donatılmıştır. Cihaza müdahale etmeksizin, 110-230 V / 50-60 Hz değerindeki bir şebeke gerilimiyle işletilmesi mümkündür.



DİKKAT!

Cihaz, tanımlanamayan çalışma akımlarından dolayı hasar görmüş.

⇒ Şebeke bağlantısından önce şebeke şalterini "O" konumuna getirin.

- ⇒ Şebeke kablosunu şebeke bağlantı yuvasına takın.
- ⇒ Şebeke kablosunun fişini topraklı prize takın.



DUYURU!

Topraklamanın yetersiz olması veya hiç olmaması durumunda, çalıştırılırken arızalar meydana gelebilir.

Doğrudan baskı mekanizmasına bağlı olan tüm bilgisayarların ve bağlantı kablolarının topraklı olduğuna dikkat edin.

- ⇒ Doğrudan baskı mekanizmasını bilgisayara veya ağ sistemine uygun bir kablo ile bağlayın.

Çalıştırma hazırlıkları

- ⇒ Baskı mekanizmasını monte edin.
- ⇒ Baskı mekanizmasını ile çalışma elektroniği arasındaki bağlantı kablosunu takın ve istenmeden çözülmeye karşı emniyete alın.
- ⇒ Basınçlı hava bağlantısını bağlayın.
- ⇒ Modül arabirimleri üzerinden, çalışma elektroniğiyle bilgisayar arasındaki bağlantıyı kurun.
- ⇒ Kumanda girişleriyle kumanda çıkışları üzerinden, çalışma elektroniğiyle paketleme makinesi arasındaki bağlantıyı kurun.
- ⇒ Kumanda elektroniğinin elektrik kablosunu bağlayın.

Baskı çalışma

Doğrudan baskı mekanizması her zaman kumanda modunda olduğundan, mevcut arabirimler (seri, paralel, USB veya belki de Baskı, baskı başlatma kumanda girişindeki bir başlatma sinyaliyle başlatılır. Çalıştırma elektroniğinin, başlatma sinyalinin ne zaman verilebileceğini görebilmesi için, baskı durumunu kumanda çıkışları üzerinden izlemek mümkün ve büyük oranda da zaten gereklidir.

Doğrudan baskı mekanizmasının devreye alma

Tüm bağlantılar kurulduktan sonra:

- ⇒ Tüm bağlantılar oluşturulduktan sonra. Modül çalıştırıldıktan sonra, modül tipinin ve geçerli tarih ve saatin görülebildiği ana menü belirir.
- ⇒ Aktarma şeridi kasetini takın. Aktarma şeridi kaseti takıldıktan sonra, aktarma şeridinin bir ölçümü yapılır ve baskı kafası baskı konumuna gider.

Aktarma şeridi kasetini takın



DUYURU!

Elektrostatik deşarj sonucu ısı baskı başının ince kaplaması ya da diğerk elektronik parçalar zarar görebileceğinden, aktarma şeridinin antistatik olması gerekir.

Yanlış malzemelerin kullanılması, doğrudan baskı sisteminin hatalı çalışmasına ve garanti hakkının kaybolmasına neden olabilir.

Dışa sarılı aktarma şeridi



DUYURU!

Yeni bir aktarma şeridi rulosunu yerleştirmeden önce, baskı başı baskı başı ve merdane temizleyicisi (97.20.002) ile temizlenmelidir.

Isopropanol (IPA)'nın kullanılmasına ilişkin işleme talimatlarına uyulmalıdır. Deri veya gözleriniz ile temas olursa, bol su ile iyice yıkayın. Eğer tahriş hissi devam ederse doktora başvurun. İyi havalandırma olmasını sağlayın.

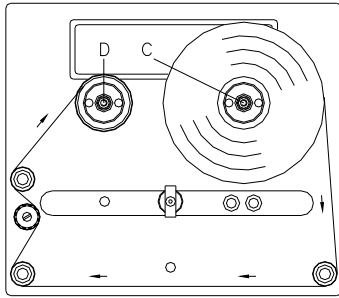
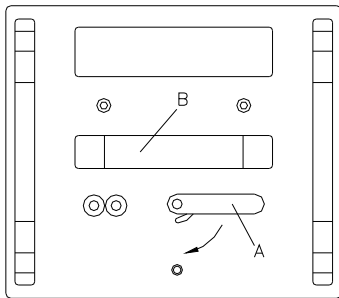

Şekil, solda bir baskı sistemi olduğunu gösterir. Sağdaki baskı sisteminde yeni makaranın sola ve kağıt çekirdeğinin de sağa takılması gerekir.

- Kolu (A) saat yönünde 90° çevirin.
- Aktarma şeridi kasetini kolundan (B) çekerek baskı mekanizmasından çıkartın.
- Yeni aktarma şeridi makarasını (A) sonuna kadar çözme tertibatına (C) takın.
- Boş kağıt kovanlarını sonuna kadar sarma tertibatına (D) takın.
- Aktarma şeridini şekildeki gibi yerleştirin.
- Aktarma şeridini yapışkan şeritle boş kovana yapıştırın ve kovayı birkaç kez çevirerek gerdirin.
- Aktarma şeridi kasetini tekrar baskı mekanizmasına geçirin ve aktarma şeridinin bunu yaparken yırtılmamasına dikkat edin.
- Kolu (A) saat yönünün tersinde 90° çevirin.

İçten sarılı aktarma şeridi

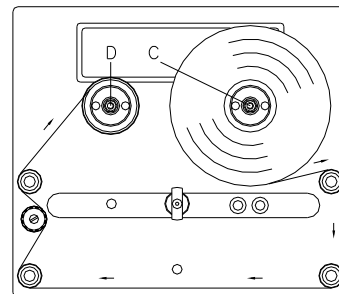
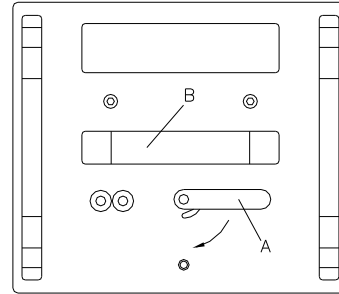

Şekil, solda bir baskı sistemi olduğunu gösterir. Sağdaki baskı sisteminde yeni makaranın sola ve kağıt çekirdeğinin de sağa takılması gerekir.

- Kolu (A) saat yönünde 90° çevirin.
- Aktarma şeridi kasetini kolundan (B) çekerek baskı mekanizmasından çıkartın.
- Yeni aktarma şeridi makarasını (A) sonuna kadar çözme tertibatına (C) takın.
- Boş kağıt kovanlarını sonuna kadar sarma tertibatına (D) takın.
- Aktarma şeridini şekildeki gibi yerleştirin.
- Aktarma şeridini yapışkan şeritle boş kovana yapıştırın ve kovayı birkaç kez çevirerek gerdirin.
- Aktarma şeridi kasetini tekrar baskı mekanizmasına geçirin ve aktarma şeridinin bunu yaparken yırtılmamasına dikkat edin.
- Kolu (A) saat yönünün tersinde 90° çevirin.

Print Settings (Yazdırmayı başlatma)

Tuş sırası: **F**

Function Menu
Print Settings

Tuş:

Sürekli mod

Contrast
(in %): 100

Contrast (Yakma gücü):

%10 ... %200 arasındaki değer alanı.

Aralıklı mod

Speed: 100
Contrast: 100

Speed (Hız):

50 mm/sn ... 200 mm/sn arasındaki değer alanı.

Contrast (Yakma gücü):

%10 ... %200 arasındaki değer alanı.

Tuş:

Ribbon Control
ON strong sens.

Transfer fibbon control (TR bandının kontrolü):

Off (Kapalı): Aktarma şeridi kontrolü devre dışı.

On (Açık): Aktarma şeridi kontrolü etkin.

strong sensibility (Güçlü hassasiyet): Modül, aktarma şeridi sonuna hemen tepki gösterir.

weak sensibility (Zayıf hassasiyet): Modül, aktarma şeridi sonuna yaklaşık 1/3 oranında daha yavaş tepki gösterir.

Tuş:

X Displacement
Offs (mm): -1.5

X-displacement (X kaydırması):

X yönündeki kaydırmanın değeri.

Değerler alanı : -90,0 ... +90,0 arası

Machine Parameters (Makine parametreleri)

Sürekli mod

Tuş sırası: **F**,

Function Menu
Machine Param.

Tuş:

Mode
IO DY

Operating mode (Mod):

İşletim türü seçimi

Tuş:

Print Offset
(mm) 10.0

Print offset (Baskı sapması):

Düzenin makinenin sıfır noktasına olan mesafesi.

Değer alanı: 1 ... 999 mm

Tuş:

Print position
(mm) 20.0

Print position (Baskı konumu):

Baskı kızığının mm cinsinden başlangıç konumu.

Değer alanı: 12 ... 93 mm

Tuş:

Layouts/cycle
1

Layouts/cycle (Düzenler/devir):

Baskı uzunluğu başına belirtilen baskı işlemleri.

Değer alanı: Devir başına 1 ... 25 düzen.

Aralıklı mod

Tuş sırası: **F**,

Function Menu
Machine Param.

Tuş:

Mode
2 continuous

Operating mode (Mod):

İşletim türü seçimi

Tuş:

Back-Speed mm/s
400

Back speed (Geri gidiş hızı):

Baskı sonundan sonra baskı mekanizmasının geri gidiş hızını mm/sn cinsinden belirtme.

Değer alanı: 50 ... 600 mm/sn arasında.

Tuş:

Print Offset
(mm) 10.0

Print offset (Baskı sapması):

Düzenin makinenin sıfır noktasına olan mesafesi.

Değer alanı: 1 ... 999 mm

Tuş:

Print position
(mm) 20.0

Print position (Baskı konumu):

Baskı kızığının mm cinsinden başlangıç konumu.

Değer alanı: 12 ... 93 mm

Sürekli modTuş: 

ChkSpeed On Strt
Off

Check speed on start (Baskı başlangıcında malzeme hızını denetleyin):

Baskı başlatma sinyalindeki materyal hızının kontrolü.

Tuş: 

Res. mm/360°
2000 166

Encoder resolution / material feed per encoder rotation (Enkoder çözünürlüğü / Beher devir verici dönüşü için malzeme ilerlemesi):

Dönüş verici devri başına mm cinsinden kodlayıcı çözünürlüğünü ve materyal kaymasını gösterir.

Tuş: 

Material speed
200 mm/s

Material speed (Materyal hızı):

Materyalin ayarlanan hızını gösterir.

Aralıklı modTuş: 

Layouts/cycle
1

Layouts/cycle (Düzenler/devir):

Baskı uzunluğu başına belirtilen baskı işlemleri.

Değer alanı: Devir başına 1 ... 25 düzen.

Layout Settings (Düzen)Tuş sırası: **F**, , 

Function menu
Layout settings

Tuş: 

Printlength (mm)
100.0

Tuş: 

Width: 20.0
Columns: 4

Tuş: 

Material
Type 2

Tuş: 

Flip layout
Off

Tuş: 

Rotate layout
On

Tuş: 

Alignment
Left

Print length (Baskı uzunluğu):

Baskı mekanizmasının gideceği mesafenin belirtilmesi. Baskı uzunluğu, baskı mekanizmasının uzunluğuna dayanır.

Column printing (Düzenin genişliği/şeritlerin sayısı):

Bir düzenin genişliğiyle ilgili bilgiler ve taşıyıcı malzemenin üzerinde yan yana kaç düzen olduğuna dair bilgiler.

Material selection (Materyali seçimi):

Kullanılan baskı ortamını seçme.

Flip layout (Düzeni yansıtın):

Yansıtma eksenini, düzenin ortasında bulunur. Düzen genişliği baskı modülüne aktarılmadığında, varsayılan düzen genişliği, yani baskı başının genişliği kullanılır. Bu nedenle düzenin baskı başıyla aynı genişlikte olmasına dikkat etmeniz gerekir. Aksi takdirde yerleştirmede sorun çıkmasına neden olabilir.

Rotat layout (Düzeni çevirin):

Standart olarak düzen, başı önde olarak 0° çevirmeye yazdırılır. Bu işlem devreye sokulduğunda düzen 180° çevrilir ve okuma yönünde yazdırılır.

Alignment (Hizalama):

Düzenin yönlendirilmesi ancak çevirmeden/yansıtmadan sonra gerçekleştirilir, yani yönlendirme, çevirmeden ve yansıtmadan bağımsızdır.

Left (Bağlantılar): Düzen, baskı başının sol kenarında hizalanır.**Centre (Orta):** Düzen, baskı başının orta noktasında hizalanır (ortalananır).**Right (Sağ):** Düzen, baskı başının sağ kenarında hizalanır.

Ribbon Save (Optimizasyon) - Sürekli mod

Tuş sırası: **F**, , , 

Function menu
Ribbon save

Tuş: 

Mode Speed
Standard 600

Operating mode (Çalışma modu):

Optimizasyon türünü seçme.

Off (Kapalı): Optimizasyon kapalı.

Standard (Standart): Azami optimal performans, yani bu ayar ile aktarma şeridi zayıflığı meydana gelmez. (Sadece, baskı alanlarının iç içe basılmaması için 1 mm'lik bir güvenlik mesafesi hariç).

SaveStrt (Başlangıç sinyali kaydetmek): Başlangıç sinyali kaybı yok, doğrudan baskı işlemi optimal kaliteyi gerekliliklere göre otomatik olarak ayarlar.

Speed (Hız): Maks. baskı hızını belirleme.

Bu değer temelinde tüm gerekli hesaplamalar gerçekleştirilir.

Modu: Standard

R-Correction
-1 mm

Transfer ribbon correction (Aktarma şeridi düzeltmesi):

0 mm = Her defasında ideal bir optimizasyon elde edilecek kadar geri çekilir (aktarma şeridi kaybı olmaz).

Varsayılan: 0 mm

-xx mm = Geri çekme azaltılabilir.

+xx mm = Geri çekme artırılabilir.

Tuş: 

sa/mm cmin so/mm
303 1000 10

Performance information (Kapasite bilgisi):

sa/mm: Tam optimizasyonda iki basınç arasındaki olabilecek en kısa mesafe.

cmin: Dakika başına maks. darbe sayısı.

so/mm: Optimizasyon kaybını belirtme.

Tuş: 

ExpertParameters

Expert parameters (Uzman parametreleri):

Parola korumalı menü

Parolayı girip,  tuşuna bastığınızda aşağıdaki parametreler gösterilir.

Tuş: 

PhDownT REStartT
30 ms 10 ms

PhDownT = Printhead down time (msn cinsinden baskı başı çalışmama süresi):

Baskı başının iniş hareketinin başlangıcı hesaplanır.

REStartT = Ribbon motor early start time (TRB Motor çalışma zamanı):

Bu değer aktarma şeridi hareketinin artma süresine eklenir. 'motor malzeme hızına erişti' ve 'baskı kafası yanıyor' arasındaki zaman için süre bildirimi.

Tuş: 

MinSpeed Calcoff
50 mm/s On

MinSpeed = Minimal print speed (minimum baskı hızı):

Min. baskı hızı artırıldığında, devirlerin maks. sayısı da artar.

Calcoff = Print offset border calculation (Baskı ofset hesaplaması):

Parametre Kapalı ayarına getirildiğinde, gereken baskı sapmasından daha küçük bir değer girilebilir.

Tuş: 

PhUpT PhVReactT
20 ms 10 ms

PhUpT = Printhead up time (msn cinsinden baskı başı çalışma süresi):

Bir alan optimizasyonunun yapılabilip yapılamayacağını hesaplaması.

PhVReactT = Printhead valve reaction time (msn cinsinden valf reaksiyon süresi):

Baskı başının yukarı hareketinin başlangıcını hesaplama.

Tuş: 

RibMotStpDlayT
2 ms

RibMotStpDlayT = Ribbon motor stop delay time (ant motoru duruş gecikme süresi):

Aktarma şeridi motorunun durmadan önce değişmeyen hız ile hareketine devam ettirildiği msn cinsinden gecikme süresi.

Tuş: 

FieldRS Rwind v
Normal 600mm/s

FieldRS = field ribbon saving:

Off (Kapalı): Alan optimizasyonu Kapalı

PHOnly: Sadece baskı başı hareket ettirilir. Aktarma şeridi durdurulmaz.

Normal: Alan optimizasyonu sadece aktarma şeridi motoru tam durdurulduğunda gerçekleştirilir.

Strong (Güçlü): Alan optimizasyonu, aktarma şeridi motoru durdurulmadığında bile gerçekleştirilir.

Rewind speed (Geri sarma hızı):

mm/sn cinsinden geri sarma değeri.

Tuş: 

Speed 1. Field
400 mm/s

Speed 1 field (Hız 1. Alan):

0 (varsayılan değer) ayarlandığında, parametrenin optimizasyon üzerinde hiçbir etkisi olmaz.

Tuş: 

Tension
0 mm

Tension (Gerilim):

Aktarma şeridini ölçükten sonra öne doğru aktarılan uzunluk değeri.

Modu: Shift

X-Shift Y-Shift
10 mm 13 mm

X-Shift / Y-Shift (X-Ofset / Y-Ofset):

X-Shift (X-Ofset): X yönündeki baskı görüntüsünün kaydırma değeri.

Y-Shift (Y-Ofset): Baskı yönündeki kaydırmanın değeri.

Tuş: 

Lanes R-Shift
3 -5 mm

Lanes / R-Shift (Şeritler / R-Ofset):

Lanes (Şeritler): Yan yana bastırılan çevrim sayısının değeri.

R-Shift (R-Ofset): Yeni bir çevrime geçiş sırasındaki mesafenin değeri.

Tuş: 

ExpertParameters

Expert parameters (Uzman parametreleri - parola korumalı):

Parolayı girip, tuşuna bastığınızda aşağıdaki parametreler gösterilir.

Tanımlama 'Standart' modu altında bulunabilir.

Modu: SaveStrt

ExpertParameters

Expert parameters (Uzman parametreleri - parola korumalı):

Parolayı girip, tuşuna bastığınızda aşağıdaki parametreler gösterilir.

Tanımlama 'Standart' modu altında bulunabilir.

Ribbon Save (Optimizasyon) - Aralıklı mod

Tuş sırası: **F**, , , 

Function menu
Ribbon save

Tuş:

Mode
Standard

Operating mode (Çalışma modu):

Optimizasyon türünü seçme.

Off (Kapalı): Optimizasyon kapalı.

Standard (Standart): Azami optimal performans, yani bu ayar ile aktarma şeridi zayıflığı meydana gelmez. (Sadece, baskı alanlarının iç içe basılmaması için 1 mm'lik bir güvenlik mesafesi hariç).

Shift (Kaydırma): Düzen verileri birden fazla kere kenarlara kaydırılarak basılabilir. Bu sayede aktarma şeridinin azami bir şekilde kullanılması mümkün olur.

Modu: Standard

R-Correction
-1 mm

Transfer ribbon correction (Aktarma şeridi düzeltmesi):

0 mm = Her defasında ideal bir optimizasyon elde edilecek kadar geri çekilir (aktarma şeridi kaybı olmaz).

Varsayılan: 0 mm

-xx mm = Geri çekme azaltılabilir.

+xx mm = Geri çekme artırılabilir.

Tuş: 

ExpertParameters

Expert parameters (Uzman parametreleri):

Parola korumalı menü

Parolayı girip, tuşuna bastığınızda aşağıdaki parametreler gösterilir.

Tuş: 

PhDownT PhUpT
35 ms 0 ms

PhDownT = Printhead down time (msn cinsinden baskı başı çalışmama süresi):

Baskı başının iniş hareketinin başlangıcı hesaplanır.

PhUpT = Printhead up time (msn cinsinden baskı başı çalışma süresi):

Bir alan optimizasyonunun yapılabiliyor yapılamayacağını hesaplaması.

Tuş: 

PhVReactT
10 ms

PhVReactT = Printhead valve reaction time (msn cinsinden valf reaksiyon süresi):

Baskı başının yukarı hareketinin başlangıcını hesaplama.

Tuş: 

Tension RM
0 mm 0

Tension (Gerilim):

Aktarma şeridini ölçükten sonra öne doğru aktarılan uzunluk değeri.

Ribbon mode (Şerit modu):

0: Aktarma şeridi her baskı sonrasında baskı uzunluğunun tamamı ile geri çekilir, yani münferit yerleşimler arasında optimizasyon gerçekleşmez.

1: Aktarma şeridi yalnızca yazdırılan alan üzerinden geri çekilir, yani yerleşimler arasındaki boşluklar optimize edilir.

Yerleşim değiştirilirken aktarma şeridi otomatik olarak konumlandırılır.

Modu: Shift

X-Shift Y-Shift
10 mm 13 mm

X-Shift / Y-Shift (X-Ofset / Y-Ofset):

X-Shift (X-Ofset): X yönündeki baskı görüntüsünün kaydırma değeri.

Y-Shift (Y-Ofset): Baskı yönündeki kaydırmanın değeri.

Tuş: 

Lanes R-Shift
3 -5 mm

Lanes / R-Shift (Şeritler / R-Ofset):

Lanes (Şeritler): Yan yana bastırılan çevrim sayısının değeri.

R-Shift (R-Ofset): Yeni bir çevrime geçiş sırasındaki mesafenin değeri.

Tuş: 

ExpertParameters

Expert parameters (Uzman parametreleri)

Parola korumalı menü

Parolayı girip, tuşuna bastığınızda aşağıdaki parametreler gösterilir.

Tanımlama 'Standart' modu altında bulunabilir.

Device Settings (Cihaz parametreleri)

Tuş sırası: **F**, , , , 

Function Menu
Device Settings

Tuş: 

Field Handling
OFF

Field handling (Alan yönetimi):

Off (Kapalı): Tüm modül belleği silinir.

Keep graphic (Grafığı alın): Bir grafik veya bir TrueType yazı tipi bir kez modüle aktarılır ve modülün dahili belleğine kaydedilir. Aşağıdaki yazdırma işi için artık sadece değiştirilen veriler, modüle aktarılır. Bunun avantajı, grafik verilerinin aktarma süresinin tasarruf edilmesidir.

Delete graphic (Grafığı silin): Modülün dahili belleğine kaydedilen grafikler veya TrueType yazı tipleri silinir, diğer alanlar ise saklı kalır.

Tuş: 

Codepage
GEM German

Codepage (Kod sayfası):

Kullanılan karakter setini seçme.

Tuş: 

ext. Parameters
ON

External parameters (Harici Parametre):

Layout dimension only (Sadece eskiz ölçüleri): Eskiz uzunluğu, yarık uzunluğu ve eskiz genişliği gibi parametreler aktarılabilir. Tüm diğer parametre ayarları direkt olarak yazıcı sistemi üzerinde yapılacaktır.

On (Açık): Parametreler, düzen tasarlama yazılımımız üzerinden modüle aktarılabilir. Daha önce doğrudan modüde ayarlanmış olan parametreler artık dikkate alınmaz.

Off (Kapalı): Sadece doğrudan modül üzerinde yapılan ayarlar dikkate alınır.

Tuş: 

Buzzer
On

Buzzer (Sesli uyarıcı):

On (Açık): Her tuşa basıldığında sesli bir sinyal duyulur.

Değerler alanı : 1 ... 7 arası

Off (Kapalı): Hiçbir sinyal duyulmaz.

Tuş: 

Language
English

Language (Modülün dili):

Metinlerin modülün göstergesinde gösterilmesini istediğiniz dili seçin.

Aşağıdaki seçenekler kullanılabilir: Almanca, İngilizce, Fransızca, İspanyolca, Portekizce, Hollandaca, İtalyanca, Danca, Fince, Lehçe, Çek veya Rusça.

Tuş: 

Customized Entry
On

Customized entry (Kullanıcı girişi):

On (Açık): Kullanıcı kontrolündeki değişkenlerin sorgusu, baskı başlatılmadan önce ekranda bir kez görünür.

Automatic (Otomatik): Kullanıcı kontrolündeki değişkenlerin sorgusu her düzenden sonra görünür.

Off (Kapalı): Ekranda kullanıcı kontrolündeki değişkenin sorgusu görünmez. Bu durumda kayıtlı varsayılan değer yazdırılır.

Tuş: 

Hotstart
Off

Hotstart (Sıcak başlatma):

On (Açık): Durdurulmuş bir yazdırma işine, modül tekrar çalıştırıldıktan sonra tekrar devam edebilirsiniz. (sadece modül Compact Flash kartı seçeneğiyle donatılmışsa).

Off (Kapalı): Modül kapandıktan sonra tüm veriler kaybolur.

Tuş: 

Password Prot.
Active

Password (Parola):

Bir parola yardımıyla çeşitli işlevler, kullanıcılara kapanabilir.

Tuş: 

Layout confirm.
On

Layout confirmation (Düzen onayı):

On (Açık): Yeni bir baskı işi ancak cihazda onaylandıktan sonra yazdırılır.

Zaten aktif olarak süren bir baskı işi, cihazdan onaylanana kadar basılmaya devam eder.

Off (Kapalı): Kumandanın ekranında hiçbir sorgu görünmez.

Tuş: 

Standard layout
Off

Standard layout (Standart yerleşim):

On (Açık): Önce bir yerleşim tanımlanmadan bir baskı işi başlatıldığında, standart yerleşim (cihaz tipi, ürün yazılımı sürümü, yapı sürümü) basılır.

Off (Kapalı): Önce bir yerleşim tanımlanmadan bir baskı işi başlatıldığında, ekranda bir hata mesajı görünür.

I/O Parameters (G/Ç parametreleri)

Tuş sırası: **F**, , , , , 

Function Menu
I/O Parameter

Tuş: 

IN signal level
1s2x3+4x5x6x7x8x

IN signal level (GİRİŞ sinyal seviyesi):

Bir baskı işinin başlatıldığı sinyali belirtme.

+ = aktif sinyal seviyesi 'yüksek' (1)

- = aktif sinyal seviyesi 'düşük' (0)

x = aktif olmayan sinyal seviyesi

s = Durum, arabirim üzerinden etkilenebilir (Netstar PLUS ile bağlantılı olarak)

Tuş: 

OUT signal level
1+2+3+4+5+6+7+8+

OUT signal level (ÇIKIŞ sinyal seviyesi):

Çıkış sinyalinin sinyal seviyesini belirtme.

+ = aktif sinyal seviyesi 'yüksek' (1)

- = aktif sinyal seviyesi 'düşük' (0)

s = Durum, arabirim üzerinden etkilenebilir (Netstar PLUS ile bağlantılı olarak)

Tuş: 

Debouncing (ms)
50

Debouncing (Geri dönme):

Besleme girişinin geri dönme süresini belirtme.

Değer alanı: 0 ... 100 msn arası

Tuş: 

Start delay (s)
1.00

Start signal delay (Başlatma sinyali gecikmesi):

Baskı başlatmasının geciktirildiği süreyi saniye cinsinden belirtme.

Değer alanı: 0,00 ... 9,99 arasında.

Tuş: 

ErrorIfNotReady
On

Not ready: error (Hazır değil: hatası):

On (Açık): Bir baskı işi aktif olduğunda, ancak (örneğin zaten 'basılıyor' modunda olduğundan dolayı) doğrudan baskı mekanizması bunu işlemeye hazır olmadığına bir hata verilir.

Off (Kapalı): Hiçbir hata mesajı verilmez.

Tuş: 

ReadyWhilePrint
Off

Ready while printing (Baskı sırasında hazır):

'Baskı için hazır' çıkış sinyalinin (Out 5, Output II) baskı sırasında aktif kalıp kalmadığının ayarı.

Off (Kapalı): Baskıya başlarken 'Baskı için hazır' sinyali devre dışı kalır (standart ayar).

On (Açık): Baskıya başlarken 'Baskı için hazır' sinyali aktif kalır.

Network (Ağ)

Tuş sırası: **F**, , , , , 

Function Menu
Network

Bu menü seçeneği hakkında daha ayrıntılı bilgiler için lütfen ayrı el kitabına bakın.

Remote Console (Uzaktaki konsol)

Tuş sırası: **F**, , , , , 

Function Menu
Remote Console

Bu menü seçeneği hakkında daha fazla bilgi edinmek için lütfen satış bölümümüze başvurun.

Interface (Arabirimler)

Tuş sırası: **F**, , , , , , , , , 

Function Menu
Interface

Tuş: 

COM1	Baud	P	D	S
0	9600	N	8	2

M = Mode (Mod):

0 - seri arabirim kapalı

1 - seri arabirim açık

2 - seri arabirim açık; bir aktarma hatasında hiçbir hata mesajı verilmez

Baud (Baud):

Saniyede aktarılan bitlerin sayısı.

Aşağıdaki değerleri seçebilirsiniz: 1200, 2400, 4800, 9600, 19200, 38400, 57600 ve 115200.

P = Parity (Parite):

N – Parite yok

E – Çift

O - Tek

Ayarların modülünkilerle eşit olmasına dikkat edin.

D = Data bits (Veri bitleri):

Veri bitlerini ayarlama (7 veya 8 bit seçeneği).

S = Stop bits (Durma bitleri):

1 veya 2 durma biti seçme hakkınız vardır.

Baytların arasındaki durma bitleri sayısı.

Tuş: 

Start (SOH):	01
End (ETB):	17

Start/stop sign (Başlama/durma işareti):

SOH: Veri aktarma bloğu başlangıcı → HEX biçimi 01

ETB: Veri aktarma bloğu sonu → HEX biçimi 17

Tuş: 

Data Memory
Advanced

Data memory (Veri belleği):

Standard (Standart): Bir yazdırma işi başlatıldıktan sonra, yazıcının ara belleği dolana kadar veri alınır.

Extended (Geliştirilmiş): Bir yazdırma işi devam ederken veri alınmaya ve işlenmeye devam eder.



Off (Kapalı): Bir yazdırma işi başlatıldıktan sonra başka veri alınmaz.

Tuş: 

Port test Off

Port test (Port testi):

Verilerin arayüz üzerinden aktarılıp aktarılmadığının denetlenmesi.

Genel olarak (On) seçmek için  ve  tuşlarına basın.  Tuşuna basarsanız, herhangi bir port üzerinden gönderilen veriler (COM1, LPT, USB, TCP/IP), yazdırılır.

Emulation (Emülasyon)

Tuş sırası: **F**, , , , , , , , , 

Function menu
Emulation



Tuş: 

Protocol
ZPL

Protocol (Protokol):

CVPL: Carl Valentin Programlama Dili

ZPL: Zebra® Programlama Dili

 ve  tuşlarını kullanarak protokolü seçin. Seçimi onaylamak için  düğmesine basın.

Yazıcı yeniden başlatılır ve ZPL II® komutları dahili olarak CVPL komutlarına dönüştürülür.

Tuş: 

Head Resolution
11.8 (Dot/mm)

Printhead resolution (Baskı başı çözünürlüğü):

ZPL II® emülasyonu devrede olduğunda, emüle edilen yazıcının baskı başının ayarlanması gerekir.

Tuş: 

Drive mapping
B:->A: R:->R:

Drive mapping (Sürücü ataması):

Zebra® sürücülerine erişim, uygun Valentin sürücülerine aktarılır.

Date & Time (Tarih ve saat)





Tuş sırası: **F**, , , , , , , , , , 

Function menu
Date/Time

Tuş: 

Date 17.11.04
Time 13:28:06

Set date/time (Tarih ve saati değiştirme):

Ekranın üst satırı, geçerli tarihi, alt satırı ise geçerli saati gösterir.  ve  tuşları yardımıyla bir sonraki alana geçip, gösterilen değerleri  ve  tuşları yardımıyla artırabilir veya azaltabilirsiniz.

Tuş: 

Summertime
On

Summertime (Yaz saati):

Açık: Modül otomatik olarak yaz veya kış saatine geçer.
Kapalı: Yaz saati otomatik olarak algılanıp değiştirilmez.

Tuş: 

ST start format
WW/WD/MM

Start of summertime - format (Yaz saati başlangıcı biçimi):

Yaz saati başlangıcını girme biçimini seçin.

DD = Gün

WW = Hafta

WD = Haftanın günü

MM = Ay

YY = Yıl,

next day = ancak bir sonraki gün dikkate alınır

Tuş: 

WW WD MM
last sunday 03

Start of summertime - date (Yaz saati başlangıç tarihi):

Yaz saatinin başlamasını istediğiniz tarihi girin. Bu giriş, daha önce seçmiş olduğunuz biçimle ilgilidir. Üstteki örnekte yaz saati Mart (03) ayının son Pazar gününde otomatik olarak değiştirilir.

Tuş: 

ST start time
02:00

Start of summertime - time (Yaz saatinin başladığı saat):

Bu işlev yardımıyla yaz saatinin başlamasını istediğiniz saati girebilirsiniz.

Tuş: 

ST end format
WW/WD/MM

End of summertime - format (Yaz saati bitişi biçimi):

Yaz saati bitişini girme biçimini seçin.

Tuş: 

WW WD MM
last sunday 10

End of summertime - date (Yaz saati bitiş tarihi):

Yaz saatinin bitmesini istediğiniz tarihi girin. Bu giriş, daha önce seçmiş olduğunuz biçimle ilgilidir. Üstteki örnekte yaz saati Ekim (10) ayının son Pazar gününde otomatik olarak değiştirilir.

Tuş: 

ST end time
03:00

End of summertime - time (Yaz saatinin bittiği saat):

Yaz saatinin bitmesini istediğiniz saati girin.

Tuş: 

Time shifting
01:00

Time shifting (Saat kayması):

Yaz/kış saatini değiştirmede saat ve dakika cinsinden saat kaymasını girin.

Service Functions (Servis işlevleri)



NOT!

Satıcı veya cihaz üreticisinin servis durumunda daha hızlı destek sağlayabilmesi için, örneğin ayarlanan parametreler gibi gerekli bilgiler doğrudan cihazdan okunabilir.

Tuş sırası: **F**, , , , , , , , , , , 

Function Menu
Service Function

Tuş: 

H P R1 R2 C ENC
0 1 1 0 0 0

Photocell parameters (Fotosel parametresi):

H = Kapak şalteri (sadece kapak şalteri olan cihazlarda)

0 = kapak açık

1 = kapak kapalı.

P = Basınç:

Basıncılı hava kontrolünün değerini belirtme (0 veya 1).

R1 = Sarma makarasının aktarma şeridi:

Sarma makarasının aktarma şeridinin durumunu belirtme. 4 durum gösterilir (fotoselde işaretleme yok, işaret sağdan geliyor, işaret soldan geliyor, işaret tam fotoselde).

R2 = Çözme makarasının aktarma şeridi:

Çözme makarasının aktarma şeridinin durumunu belirtme. 4 durum gösterilir (fotoselde işaretleme yok, işaret sağdan geliyor, işaret soldan geliyor, işaret tam fotoselde).

C = Araç:

Baskı kızağının konumunu belirtme.

ENC = Kodlayıcı:

Dönüş vericinin geçerli durumunu belirtme.

Tuş: 

Paper Counter
D000007 G000017

Paper counter (Çalışma kapasitesi):

D: Baskı başı gücünün metre cinsinden değeri.

G: Cihaz gücünün metre cinsinden değeri.

Tuş: 

Heater Resist.
1250

Heater resistance (Nokta direnci):

İyi bir baskı resmi elde etmek için baskı başı değişikliği durumunda baskı başında belirtilen Ohm değerinin ayarlanması gerekir.

Tuş: 

Printhead Temp.
23

Printhead temperature (Baskı başı sıcaklığı):

Baskı başı sıcaklığının değeri.

Tuş: 

Ribbon Ink Side
600 m Out

Ribbon / Ink side (Şerit / mürekkep tarafı):

Ribbon (Şerit): Kullanılan aktarma şeridi uzunluklarını seçme (300 m, 450 m, 600 m, 900 m, 1000 m).

Ink side (mürekkep tarafı): Dışa veya içe sargılı aktarma şeritlerinin kullanılmasının seçimi. Varsayılan: Dışa sargılı

Tuş: 

BrkPow BrkPowP
100 % 100 %

Brake power (Fren gücü):

BrkPow:

Frenleme gücünü hızlanma ve frenleme için % olarak ayarlama.

BrkPowP:

Frenleme gücünü baskı sırasında ayarlama.

Tuş: 

Print Examples
Settings

Print examples (Yazdırma örnekleri):

Bu menü seçeneğini çalıştırdığınızda tüm yazıcı ayarlarının bir çıktısını alabilirsiniz.

Settings (Durum raporu):

Örneğin hız, etiket, aktarma bandı malzemesi vs. gibi tüm yazıcı ayarları yazdırılır.

Bar codes (Barkodlar):

Kullanılabilir tüm Barkodlar yazdırılır.

Fonts (Yazı Tipleri):

Tüm Vektörler ve Bit Eşlem Yazı Tipleri yazdırılır.

Tuş: 

Input: 11111111
Output: 00000000

Input/Output (Giriş/Çıkış):

Yazdırmanın hangi sinyalde başlatıldığını gösteren sinyal seviyeleri göstergesi (0 – düşük; 1 – yüksek).

Tuş: Diagnostic
Enter**Diagnostic (Teşhis):**Seçimi onaylamak için düğmesine basınTuş: EncProf NoOfProf
Off 10**Encoder profiling (Kodlayıcı profili):**

Dönüş verici değerleri ile Kayıt tutma dosyalarındaki baskı başlangıcı, CF kartına kaydedilir. Bu veriler sayesinde dönüş vericisi eğrisinin grafik bir görünüm resmi oluşturulabilir.

Tuş: DiaRU DiaRW
68mm 655mm**Roller diameter (Aktarma şeridi makaralarının çapı):****DiaRW** = Aktarma şeridi sarma makarasının çapı.**DiaRU** = Aktarma şeridi çözme makarasının çapı.Tuş: Enc. Average
100**Encoder average (Kodlayıcı ortalaması):**

Kodlayıcı sinyallerinin ortalığı değeri sayısını.

Tuş: IgnrStrt IntPrts
123 456**Diagnostic - Counter (Teşhis sayacı):****IgnrStrt** = Göz ardı edilen başlatma sinyallerinin sayacı.**IntPrts** = İptal edilen baskı işlerinin sayacı.İmleçle, daha ayrıntılı bilgi edinmek istediğiniz değeri seçin ve tuşuna basın.Tuş: Njb Nrd Prt
+000 +999 +999**NJb = No job (İş yok):**

Baskı işi aktif olmadığından dolayı göz ardı edilen başlatma sinyallerinin sayacı.

NRd = Not ready (Hazır değil):

Baskı işi hazır olmadığından (durdurulduğundan veya hata mesajı olduğundan) dolayı göz ardı edilen başlatma sinyallerinin sayacı.

Prt = Printing (Yazdırıyor):

Cihaz yazdırırken/çalışırken göz ardı edilen başlatma sinyallerinin sayacı.

Tuş: MS/I ItfI SpdS
+000 +999 +999**MS/I = Manual stopped/interrupted (Manüel olarak durduruldu/kesildi):**

Folyo klavyesindeki, panodaki veya bir programdaki Durdur tuşuna basıldı.

ItfI = Interface interrupted (Arabirim kesildi):

Bir arabirim üzerinden yeni veriler alındığından, baskı işi iptal edildi.

SpdS = Speed stopped (Hız durduruldu):

Ölçülen baskı hızı çok yavaş olduğundan, baskı işi iptal edildi.

Tuş: On/Offline
Off**Online/Offline (Çevrimiçi/Çevrimdışı):**Bu işlev etkinleştirildiğinde, tuşuyla Çevrimiçi moduyla Çevrimdışı modu arasında geçiş yapabilirsiniz.

Standart: Kapalı

Online (Çevrimiçi): Veriler, arabirimler üzerinden alınabilir. Folyolu klavyenin tuşları sadece tuşuyla Çevrimdışı moduna geçildiğinde aktiftir.**Offline (Çevrimdışı):** Folyolu klavyenin tuşları tekrar aktiftir, ancak alınan veriler artık

işlenmez. Cihaz tekrar Çevrimiçi moda döndüğünde tekrar yeni baskı işleri alınır.

Tuş: TR advance warn.
On ø: 40 v: 100**Transfer ribbon prior warning (Aktarma şeridi ön uyarısı):**

Aktarma şeridi bitmeden önce, bir kumanda çıkışı üzerinden bir sinyal verilir.

Warning diameter (Uyarı çapı):

Aktarma şeridinin ön uyarı çapını mm cinsinden ayarlama.

Burada mm cinsinden bir değer girildiğinde, (aktarma şeridi makarasında ölçülen) bu değere ulaşıldığında bir kumanda çıkışı üzerinden bir sinyal verilir.

v = reduced speed (Azaltılmış baskı hızı):

Azaltılmış baskı hızının ayarlanması. Bu, normal baskı hızı sınırlarında ayarlanabilir.

-: Azaltılmış baskı hızı yok

0: Ön uyarı ölçere ulaşıldığında yazıcı, 'Aktarma şeridi hatası' ile durur.

Main Menu (Ana menü)

Modül çalıştırdıktan sonra, ekranda aşağıdaki gösterge belirir:



* DC c107-12K * 14/09/05 10:16	İlk satır = Ana menü. İkinci satır = geçerli tarih ve saat
Tuş: <input type="radio"/>	
* DC c107-12K * V1.44	İkinci satır = Ürün yazılımının sürüm numarası.
Tuş: <input type="radio"/>	
* DC c107-12K * Build 0201	İkinci satır = Yazılımın yapım (Build) sürümü.
Tuş: <input type="radio"/>	
* DC c107-12K * Jun 2 2005	İkinci satır = Ürün yazılımının oluşturulduğu tarih.
Tuş: <input type="radio"/>	
* DC c107-12K * 10:37:34	İkinci satır = Ürün yazılımı sürümünün oluşturulduğu saat.
Tuş: <input type="radio"/>	
* DC c107-12K * B-Font: V5.01	İkinci satır = Biteslem yazı tiplerinin yazı tipi sürümü.
Tuş: <input type="radio"/>	
* DC c107-12K * V-Font: V1.01	İkinci satır = Vektör yazı tiplerinin yazı tipi sürümü.
Tuş: <input type="radio"/>	
* DC c107-12K * FPGA V1.4.0 T9	İkinci satır = FPGA'nın sürüm numaraları.
Tuş: <input type="radio"/>	
* DC c107-12K * 16 MB Memory	İkinci satır = Cihazın MB cinsinden bellek kapasitesi
Tuş: <input type="radio"/>	
* DC c107-12K * 8 MB FLASH	İkinci satır = FLASH'ın MB cinsinden bellek kapasitesi
Tuş: <input type="radio"/>	
* DC c107-12K * A0 MO V.1.3.1 AB	İkinci satır = İlk işlemcinin sürüm numarası (motor başlatması)
Tuş: <input type="radio"/>	
* DC c107-12K * A1 MO V.1.3.1 AB	İkinci satır = İkinci işlemcinin sürüm numarası (motor başlatması)
Tuş: <input type="radio"/>	
* DC c107-12K * A2 IO V.1.3.1 AB	İkinci satır = Üçüncü işlemcinin sürüm numarası (G/Ç denetimi)

CF Card (Compact Flash Kartı)

Select layout (Sayfa düzenini seçin)

Tuş sırası: 



→layout 01 0
A:\STANDARD

STANDARD dizindeki istediğiniz sayfa düzenini seçmek için  ve  tuşlarına basın.
Sayfa düzenini seçmek için düğmesine basın.

Start print
No.layout: 12345

Yazdırılmasını istediğiniz sayfa düzeni sayısını seçin.
Baskı işini başlatmak için düğmesine basın.

Load file (Dosyayı CompactFlash Kartından yükleyin)

Tuş sırası: , 

CF Functions
Load file

Tuş:

□→ .. <
A:\STANDARD

İstediğiniz dosyayı seçin ve ile seçiminizi onaylayın.

 tuşuna basın ve istediğiniz parça adedini girin. Seçiminizi ile onayladığınızda baskı işi, harici bir sinyal (giriş 1, pim 1 ve pim 4) üzerinden devreye sokulur.

Save layout (Düzeni Compact Flash Kartına kaydedin)

Tuş sırası: , , 

CF Functions
Save layout

Tuş:

File exists
Overwrite?

Kaydetmek istediğiniz dizini/düzeni seçin ve seçiminizi ile onaylayın.

Yukarıdaki sorguyu ile onayladığınızda düzen kaydedilir.

Save configuration (Yapılandırmayı kaydedin)

Tuş sırası: , , , 

CF Functions
Save config

Standart olarak config.cfg dosya adı teklif edilir. Bu, kullanıcı tarafından değiştirilebilir. Bu dosyada, baskı modülünün kalıcı olarak dahili flaşta kaydedilmeyen parametreleri kaydedilir.

Kayıt işlemini başlatmak için düğmesine basın.

Change directory (Dizini değiştirin)



Tuş sırası: , , , , 



CF Functions
Change directory

Tuş:

←<.> M
A:\STANDARD\

Alt satırda o sırada seçili olan dizin gösterilir.

Dizini üst satıra geçirmek için  ve  tuşlarına basın.

Olası dizinleri göstermek için  ve  tuşlarına basın.

Seçilen dizini devralmak için düğmesine basın.

Delete file (Dosyayı Compact Flash Karttan silin)

Tuş sırası: , , , , , 

CF Functions
Delete file

Silmek istediğiniz dizini veya düzeni seçin ve seçiminizi ile onaylayın.

Format CF card (Compact Flash Kartı formatlayın)

Tuş sırası: , , , , , , 

CF Functions
Format

Tuş:

Format A:

 tuşuyla Compact Flash Karttaki formatlamak istediğiniz diski seçin ve seçiminizi ile onaylayın. Formatlama sırasında STANDART dizini otomatik olarak oluşturulur.

Free memory space (Compact Flash Karttaki boş hafıza alanını gösterin)

Tuş sırası: , , , , , , 

CF Functions
Free memory

Compact Flash Kartta kalan kullanılabilir boş bellek alanı gösterilir.

Teknik veriler

	Dynacode 53	Dynacode 107	Dynacode 128
Çözünme	300 dpi	300 dpi	300 dpi
Baskı hızı			
sürekli mod	50 ... 800 mm/s	50 ... 600 mm/s	50 ... 450 mm/s
aralıklı mod	50 ... 600 mm/s	50 ... 600 mm/s	50 ... 600 mm/s
Geri gitme hızı	sadece aralıklı modda: maks. 600 mm/sn		
Geçiş genişliği	53,3 mm	106,6 mm	128 mm
Maks. Baskı uzunluğu			
sürekli mod	6000 mm	3000 mm	3000 mm
aralıklı mod	75 mm	75 mm	75 mm
Çerçevenin geçiş genişliği	müşteri talebine göre	müşteri talebine göre	müşteri talebine göre
Baskı başı	Corner Type	Corner Type	Corner Type
Ses emisyonu (ölçüm mesafesi 1 m)			
Orta ses gücü seviyesi	60 dB(A)	65 dB(A)	68 dB(A)
Aktarma şeridi			
Renkli taraf	dış veya iç (opsiyon)	dış veya iç (opsiyon)	dış veya iç (opsiyon)
Maks. rulo çapı	98 mm	82 mm	75 mm
Çekirdek çapı	25,4 mm / 1"	25,4 mm / 1"	25,4 mm / 1"
Maks. uzunluk	900 m	600 m	450 m
Maks. genişlik	55 mm	110 mm	130 mm
Ebatlar (Genişlik x Yükseklik x Derinlik)			
Baskı mekanizması			
montaj çerçevesi yok	204 x 180 x 234 mm	204 x 180 x 290 mm	204 x 180 x 312 mm
takma çerçevesi	Geçiş genişliğine bağlıdır		
Başlatma elektroniği	240 x 125 x 332 mm Mekanizmayla bağlantı kablosu seti 2,5 m		
Ağırlık yaklaşık			
Baskı mekanizması	9,5 kg	11 kg	11,7 kg
Elektronik (kablo dahil)	5,5 kg	5,5 kg	5,5 kg
Elektronik			
İşlemci	Yüksek Hız 32 Bit		
Bellek (RAM)	16 MB / 64 MB (istek üzerine)		
Yuva	Compact Flash kart tipi I için		
Pil	Gerçek zamanlı saat için (elektrik kesildiğinde veri kaydı)		
Uyarı sinyali	Hatada sesli sinyal		
Arabirimler			
Seri	RS-232C (ila 115200 Baud)		
Paralel	Centronics		
Ethernet	10/100 Base T		
USB	1.1		
Bağlantı değerleri			
Pnömatik bağlantı	min. 6 bar kuru ve yağsız		
Besleme voltajı standart	110 ... 230 V / 50 ... 60 Hz		
Elektrik	230 V / 1,5 A – 110 V / 3 A		
Sigorta değerleri	230 V / 2 AT – 110 V / 4 AT		
İşletim koşulları			
Sıcaklık	5 ... 40 °C		
Nispi nem	maks. 80% (yoğuşmaz)		

Kumanda alanı	
Tuşlar	Test baskı, fonksiyon menüsü, parça adedi, CF kartı, Besleme, Enter, 4 x imleç
LCD göstergesi	Grafik ekran 132 x 32 piksel yeşil arka plan aydınlatması
Ayarlar	
	Tarih, saat, vardiya saatleri 11 dil ayarı (istek üzerine başkaları) Etiket, cihaz numarası, arayüzler, parola koruması
Denetimler	
Baskı durdurması yeri	Aktarma bant sonu / düzen sonu / baskı başı açık
Durum baskısı	Örneğin çalışma kapasitesi, fotosel, arayüz, şebeke parametreleri gibi cihaz ayarlarının baskısı Dahili yazı tiplerinin ve desteklenen tüm barkodların baskısı
Yazılar	
Yazı tipleri	6 biteşlem yazı tipleri 8 vektör yazı tipleri/TrueType yazı tipleri 6 orantılı yazı tipleri Diğer yazı tipleri istek üzerine
Karakter setleri	Windows 1250 ila 1257, DOS 437, 850, 852, 857 Tüm Batı ve Doğu Avrupa, Latin, Kiril, Yunan ve Arap (opsiyon) karakterler destekleniyor. Diğer karakter setleri istek üzerine
Biteşlem Yazı Tipleri	Genişlik ve yükseklik olarak boyut 0,8 ... 5,6 Büyütme faktörü 2 ... 9 Hizalama 0°, 90°, 180°, 270°
Vektör yazı tipleri/TrueType yazı tipleri	Genişlik ve yükseklik olarak boyut 1 ... 99 mm Kademesi büyütme faktörü Hizalama 0°, 90°, 180°, 270°
Yazı öznitelikleri	Yazı türüne bağlıdır: Kalın, yatık, ters, dikey
Karakter aralığı	Değişken
Barkodlar	
1D barkodlar	CODABAR, Code 128, Code 2/5 interleaved, Code 39, Code 39 extended, Code 93, EAN 13, EAN 8, EAN ADD ON, GS1-128, Identcode, ITF 14, Leitcode, Pharmacode, PZN 7 Code, PZN 8 Code, UPC-A, UPC-E
2D barkodlar	Aztec Code, CODABLOCK F, DataMatrix, GS1 DataMatrix, MAXICODE, PDF 417, QR Code
Kompozit barkodlar	GS1 DataBar Expanded, GS1 DataBar Limited, GS1 DataBar Omnidirectional, GS1 DataBar Stacked, GS1 DataBar Stacked Omnidirectional, GS1 DataBar Truncated
	Tüm barkodların yüksekliği, modül genişliği ve oranı değişkendir Hizalama 0°, 90°, 180°, 270° İsteğe bağlı olarak kontrol rakamı ve net yazı baskısı
Yazılım	
Konfigürasyon	ConfigTool
İşlem kumandası	NiceLabel
Etiket yazılımı	Labelstar Office Lite Labelstar Office
Windows sürücüsü	Windows XP® 32/64 Bit, Windows Vista® 32/64 Bit Windows 7® 32/64 Bit, Windows 8® 32/64 Bit Windows 8.1® 32/64 Bit, Windows Server 2003® (R2) 32/64 Bit Windows Server 2008® 32/64 Bit, Windows Server 2008® (R2) 64 Bit Windows Server 2012® 64 Bit, Windows Server 2012® (R2) 64 Bit

Teknik değişiklik hakkı saklıdır.

Temizleme ve Bakım



TEHLİKE!

Elektrik çarpması nedeniyle hayati tehlike!

⇒ Bakım işlerine başlamadan önce modülün fişini elektrik şebekesinden çıkarın.

Yazdırma kafasının temizlenmesi



DUYURU!

Cihazın temizlenmesi esnasında, koruma gözlüğü ve eldiven gibi kişisel koruma donanımı kullanılması tavsiye edilir.

Yazdırma esnasında yazdırma kafasında, baskı kalitesini olumsuz etkileyen kirler birikebilir, örn. kontrast farklılıkları veya dikey şeritler nedeniyle.



DİKKAT!

Yazdırma kafası hasarı!

⇒ Yazdırma kafasını temizlemek için aşındırıcı veya sert malzemeler kullanmayın.
⇒ Yazdırma kafasının cam koruma tabakasına dokunmayın.

- Aktarma şeridi kasetini çıkartın.
- Yazdırma kafası yüzeyini özel temizleme kalemiyle veya saf alkole bandırılmış pamuk çubuğu ile temizleyin.
- Modülü ilk çalıştırma işleminden önce yazdırma kafasının 2–3 süreyle kurumasını bekleyin.



DUYURU!

Isopropanol (IPA)'nın kullanılmasına ilişkin işleme talimatlarına uyulmalıdır. Deri veya gözleriniz ile temas olursa, bol su ile iyice yıkayın. Eğer tahriş hissi devam ederse doktora başvurun. İyi havalandırma olmasını sağlayın.

Baskı başını değiştirin



DİKKAT!

Baskı başını elektrostatik deşarj veya mekanik etkiler sonucu hasar görmüş!

⇒ Cihazı topraklanmış, iletken zemine kurun.
⇒ Vücudunuzu, örneğin topraklanmış bir bilek kemeri takarak topraklayın.
⇒ Fiş bağlantılarındaki bağlantılara dokunmayın.
⇒ Baskı çubuğuna sert eşyalarla veya elinizle dokunmayın.

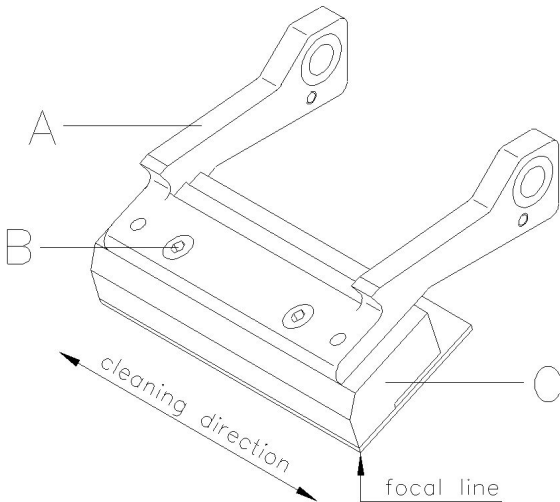

Baskı başını sökün

- Aktarma şeridi kasetini çıkartın.
- Baskı başı ünitesini uygun hizmet konumuna itin.
- Baskı başı tutucusunu (A), bir somun anahtarı (SW 2,5) vidaya (B) takılana kadar hafif aşağı basın.
- Vidaları (B) sökün ve baskı başını (C) çıkarın.
- Fiş bağlantısını arka tarafta baskı başından çekip çıkartın.

Baskı başını takın

- Fiş bağlantılarını yeni baskı başına takın.
- Avcılar, baskı başı tutucusundaki (A) uygun delikleri kavrayana kadar baskı başını baskı başı tutucusuna (A) yerleştirin.
- Baskı başı tutucusunu (A) bir parmakla hafif baskı merdanesinde tutun ve baskı başının (C) doğru konumda olup olmadığını kontrol edin.
- Vidayı (B) altı köşeli anahtarla vidalayın ve sıkın.
- Aktarma şeridi materyalini tekrar yerleştirin.
- Hizmet işlevlerinde (nokta direnci), yeni baskı başının direnç değerini girin. Bu değer, baskı başının model plakasında bulunur.
- Baskı başının konumunu, bir test baskısı yardımıyla kontrol edin.

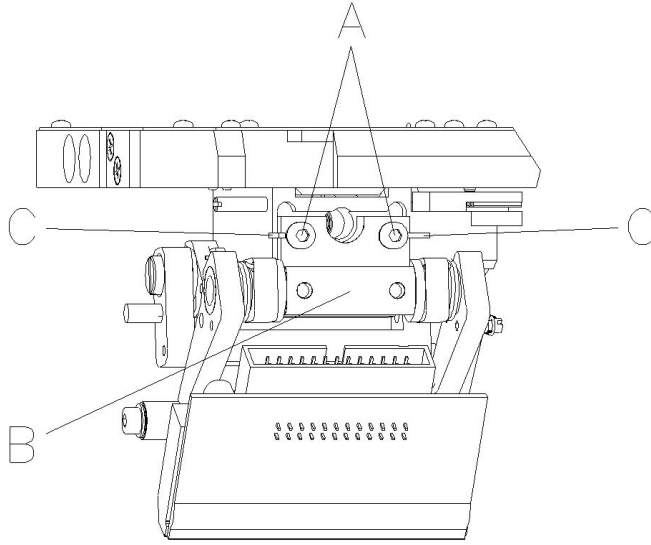
Açı ayarı (aralıklı mod)

Baskı başının montaj açısı, standart olarak baskı yüzeyine 26°'dir. Baskı başının ve mekaniğin üretim toleransları ise başka bir açı gerektirebilir.

**DİKKAT!**

Dengesiz aşınma sonucu baskı başı zarar görebilir!
Daha hızlı yırtılma sonucu aktarma şeridinin daha fazla aşınması.
⇒ Fabrika ayarlarını sadece istisna durumlarda değiştirin.

- İç altı köşeli vidaları (A) biraz çözün.
- Baskı başıyla baskı başı tutucusu arasındaki açığı değiştirmek için ayar parçasını (B) kaydırın.
Aşağı kaydırma = Açı küçülür
Yukarı kaydırma = Açı büyür
- İç altı köşeli vidayı (A) tekrar sıkın.
- Baskı işini yaklaşık 3 düzen üzerinden başlatın ve düzgün, kırışksız bir şerit gidişi olup olmadığını kontrol edin.

**DUYURU!**

Ayarlanan aralıklar (C), konum kontrolü için kullanılır. Olabildiğince paralel bir ayar olmasına dikkat edilmesi gerekir.



Carl Valentin GmbH
Neckarstraße 78 – 86 u. 94 . D-78056 Villingen-Schwenningen
Phone +49 (0)7720 9712-0 . Fax +49 (0)7720 9712-9901
info@carl-valentin.de . www.carl-valentin.de